



US00D724707S

(12) **United States Design Patent**
Murphy

(10) **Patent No.:** **US D724,707 S**
(45) **Date of Patent:** **** Mar. 17, 2015**

- (54) **INFANT BATH TUB**
- (71) Applicant: **Shnuggle Ltd.**, Newtownards (GB)
- (72) Inventor: **Adam Murphy**, Newtownards (GB)
- (73) Assignee: **Shnuggle Ltd.**, Newtownards (GB)
- (**) Term: **14 Years**
- (21) Appl. No.: **29/500,917**
- (22) Filed: **Aug. 29, 2014**
- (51) **LOC (10) Cl.** **23-02**
- (52) **U.S. Cl.**
USPC **D23/278**
- (58) **Field of Classification Search**
USPC D23/278, 277, 280.1, 280.3, 303-304;
4/538, 586, 582, 572.1
See application file for complete search history.

D694,867 S * 12/2013 Quigley D23/277
 D709,598 S * 7/2014 Dupras D23/280.1
 2011/0088158 A1 4/2011 Cerasani

FOREIGN PATENT DOCUMENTS

NL 1033953 6/2007

* cited by examiner

Primary Examiner — Robert Delehanty

(74) *Attorney, Agent, or Firm* — Evergreen Valley Law Group; Kanika Radhakrishnan

(57) **CLAIM**

The ornamental design for an infant bath tub, as shown and described.

DESCRIPTION

FIG. 1 is an isometric view of an infant bath tub showing my new design;
 FIG. 2 is a front elevation view thereof;
 FIG. 3 is a rear elevation view thereof;
 FIG. 4 is a side elevation view thereof;
 FIG. 5 is a side elevation view thereof;
 FIG. 6 is a top plan view thereof;
 FIG. 7 is a bottom plan view thereof; and,
 FIG. 8 is a section view thereof taken on line 8-8 of FIG. 2.

1 Claim, 8 Drawing Sheets

(56) **References Cited**

U.S. PATENT DOCUMENTS

D235,105 S * 5/1975 Dorman D23/280.1
 D299,741 S 2/1989 Thom
 5,588,159 A 12/1996 Poulson et al.
 D469,860 S * 2/2003 Riemer et al. D23/278
 D592,289 S * 5/2009 Williams et al. D23/277
 D619,225 S 7/2010 Tu

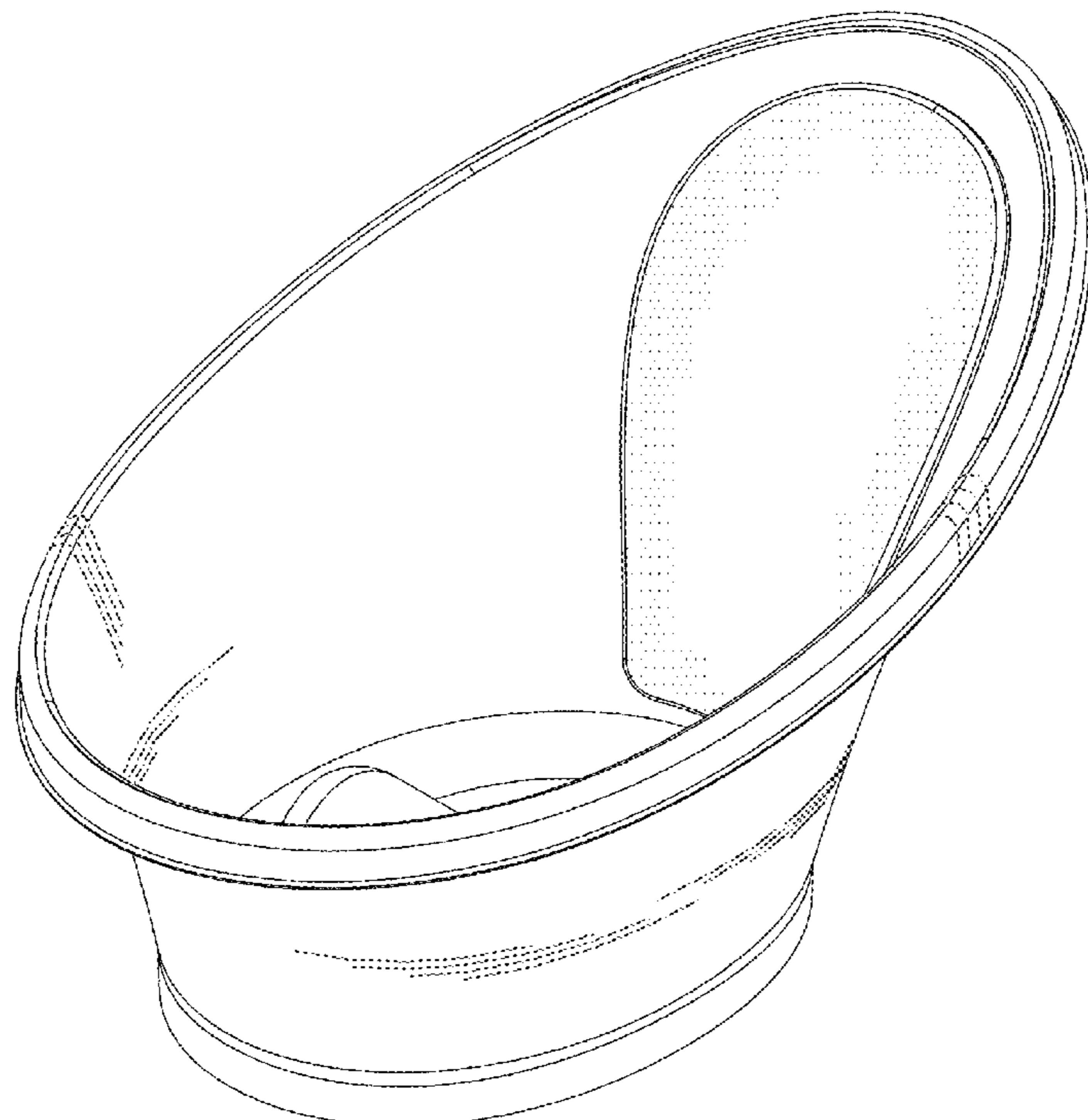

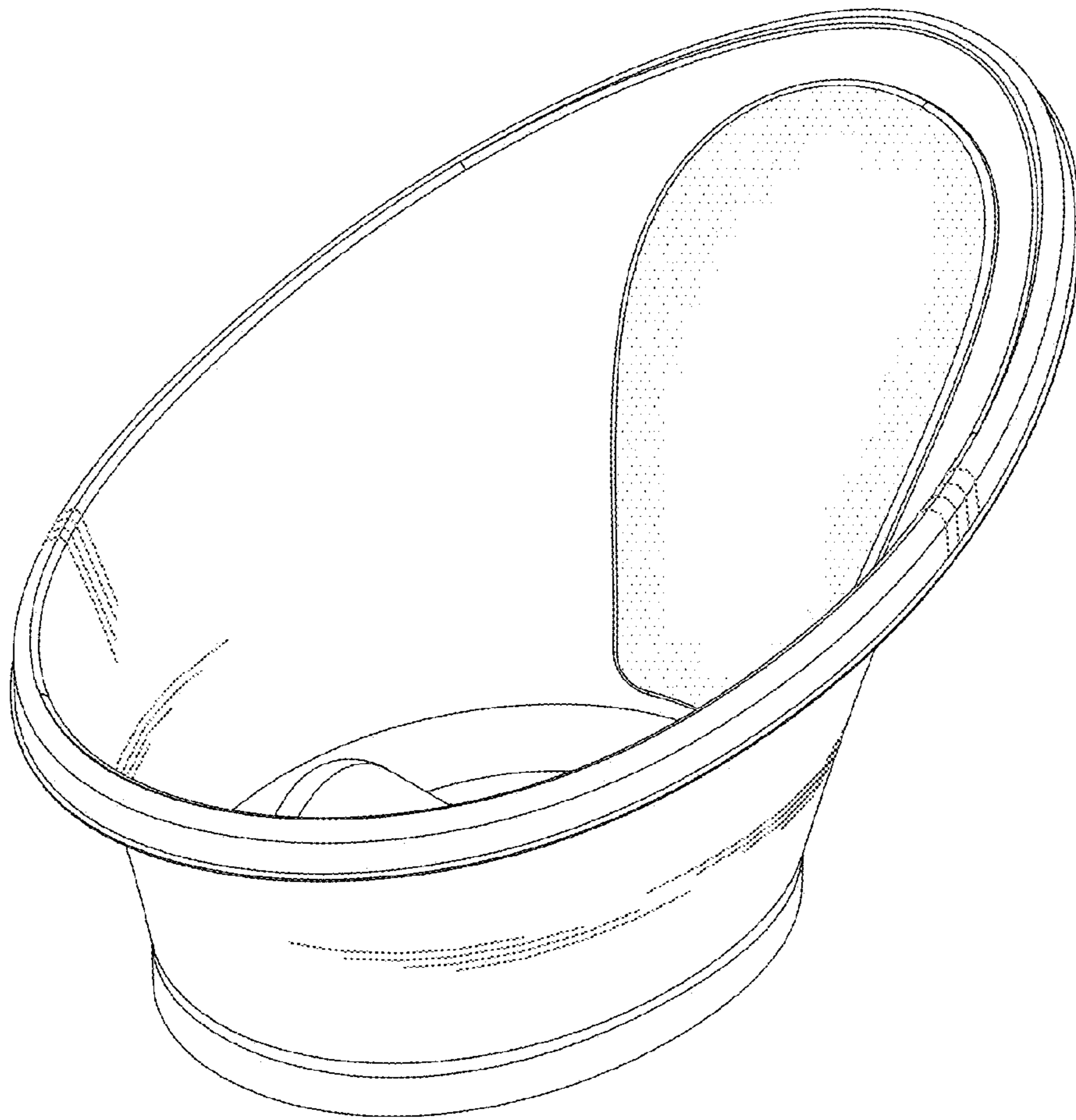

FIG. 1

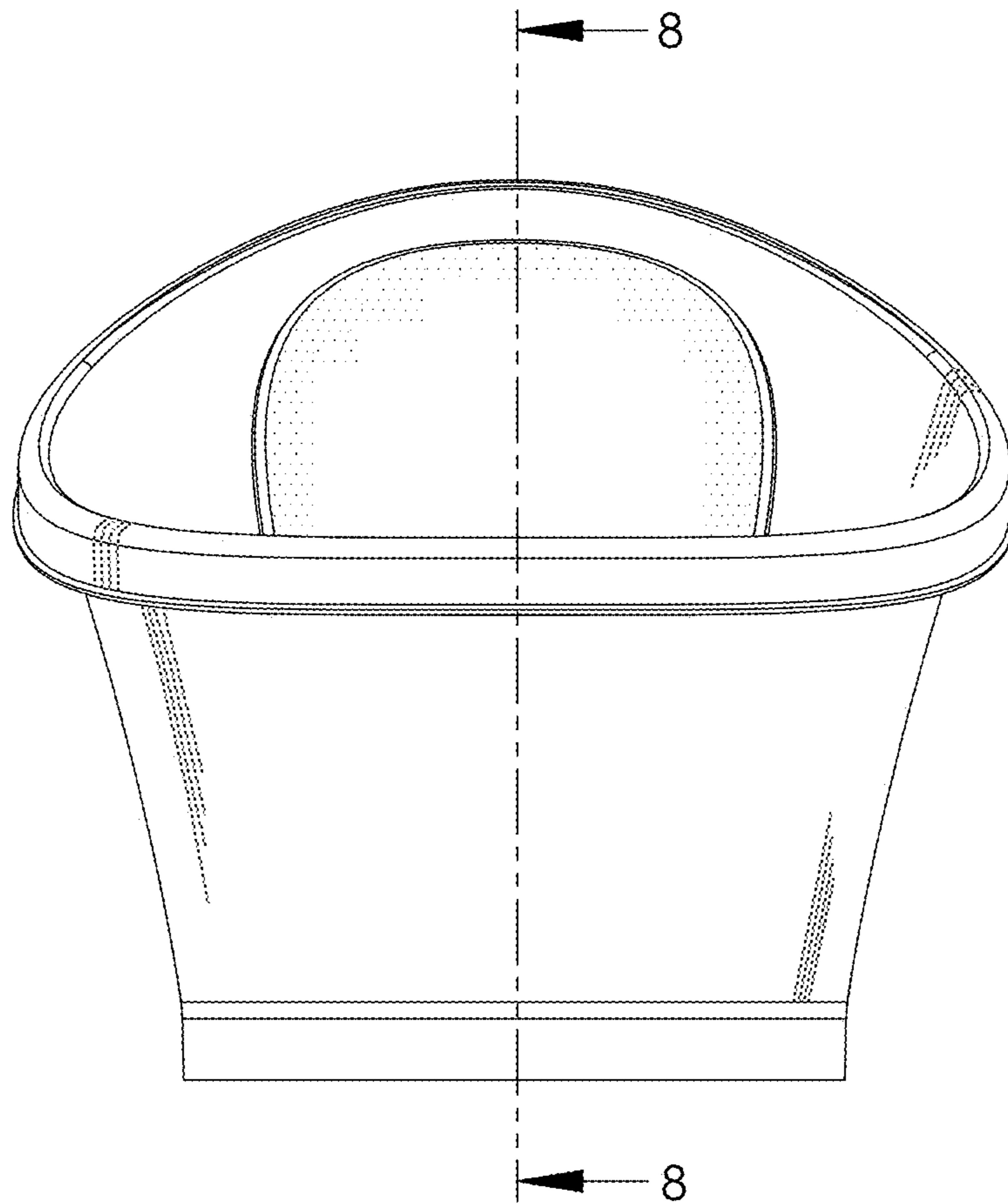

FIG. 2

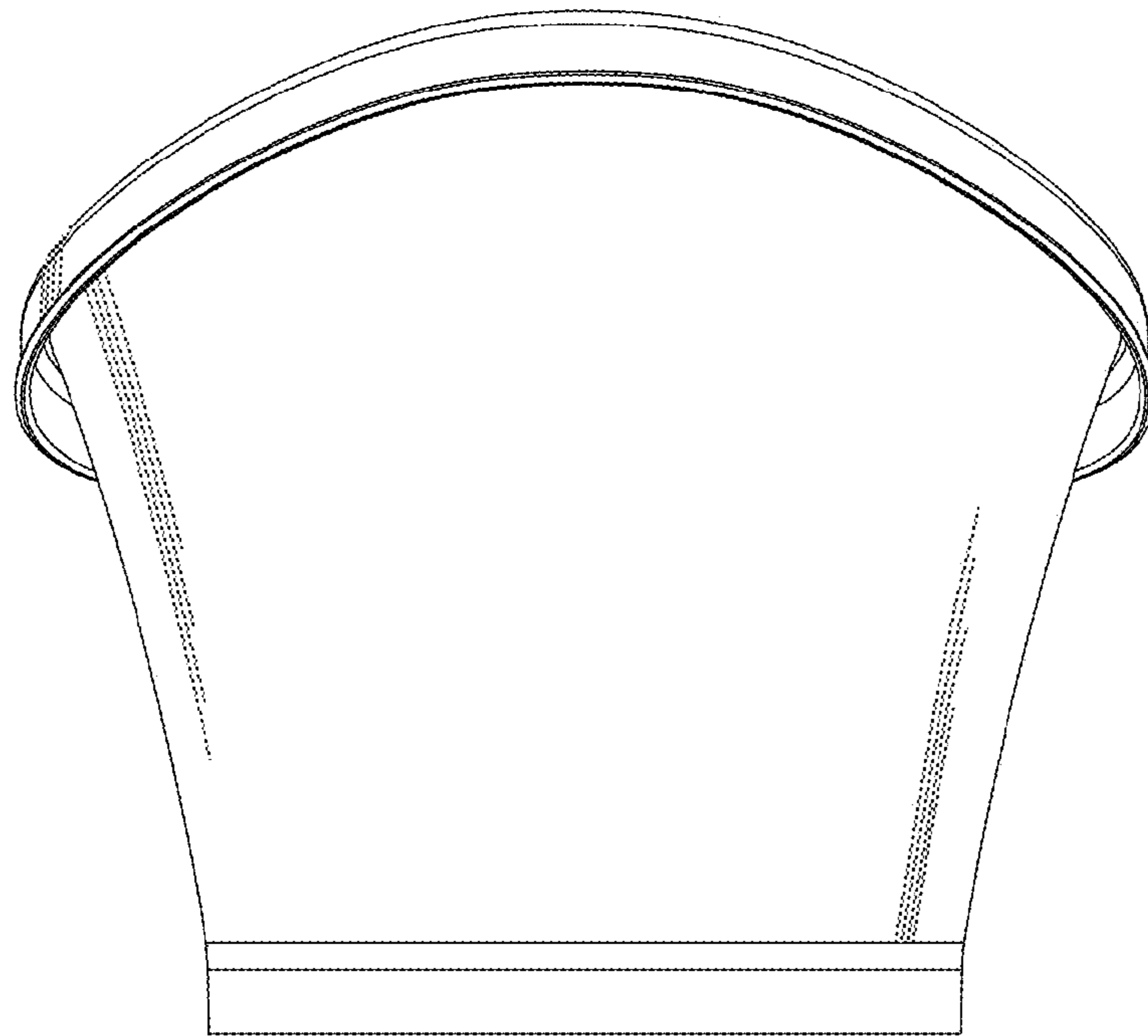

FIG. 3

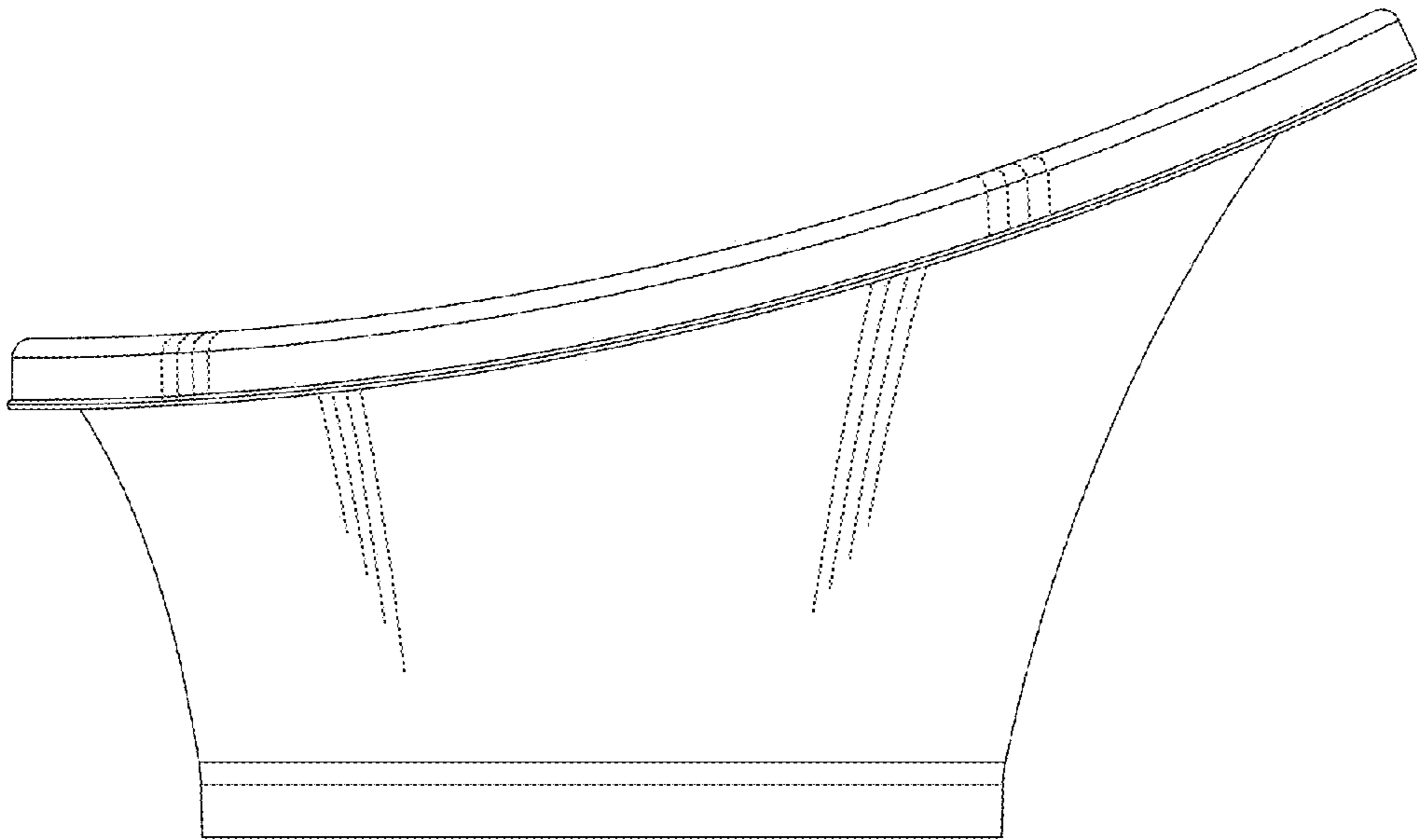

FIG. 4

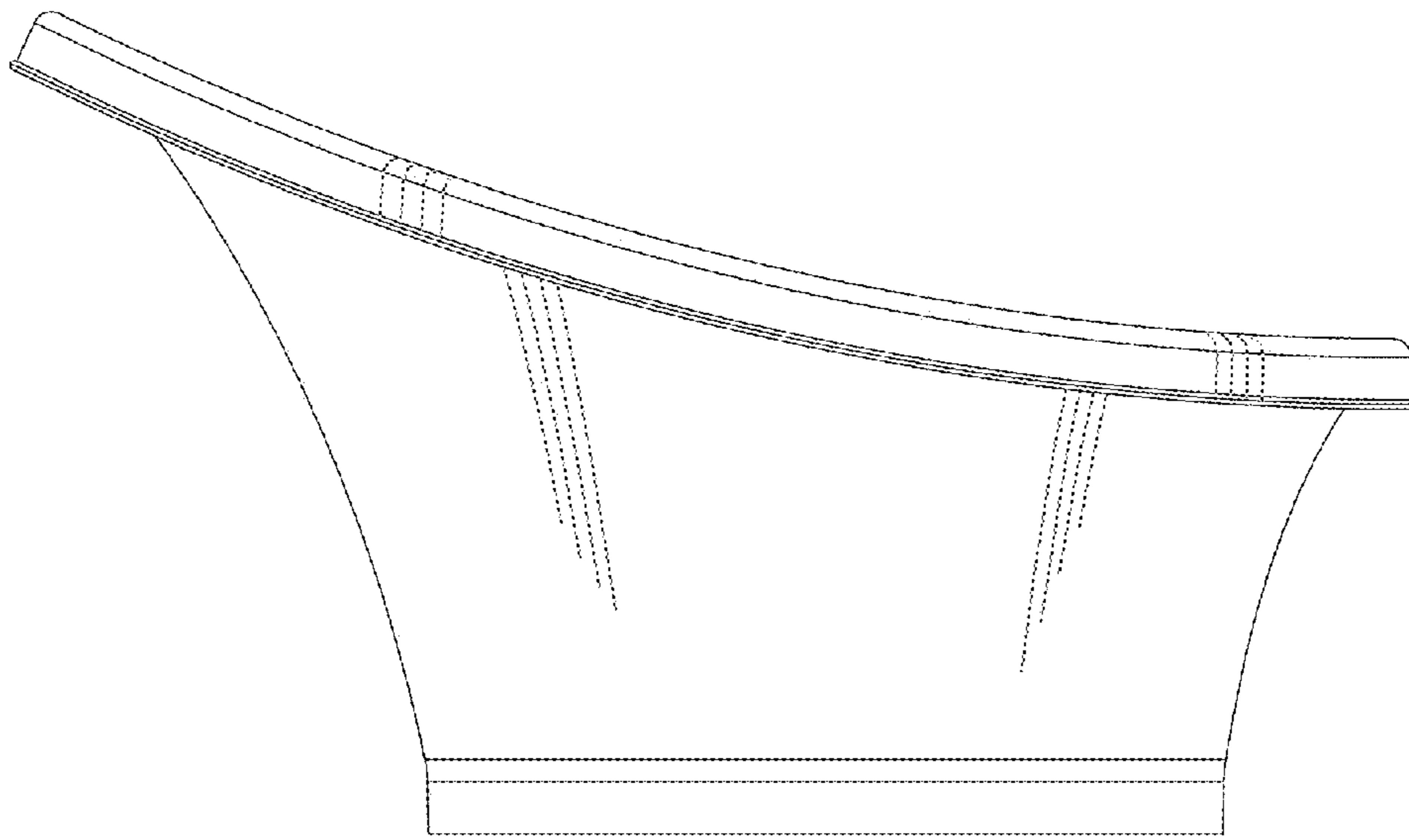

FIG. 5

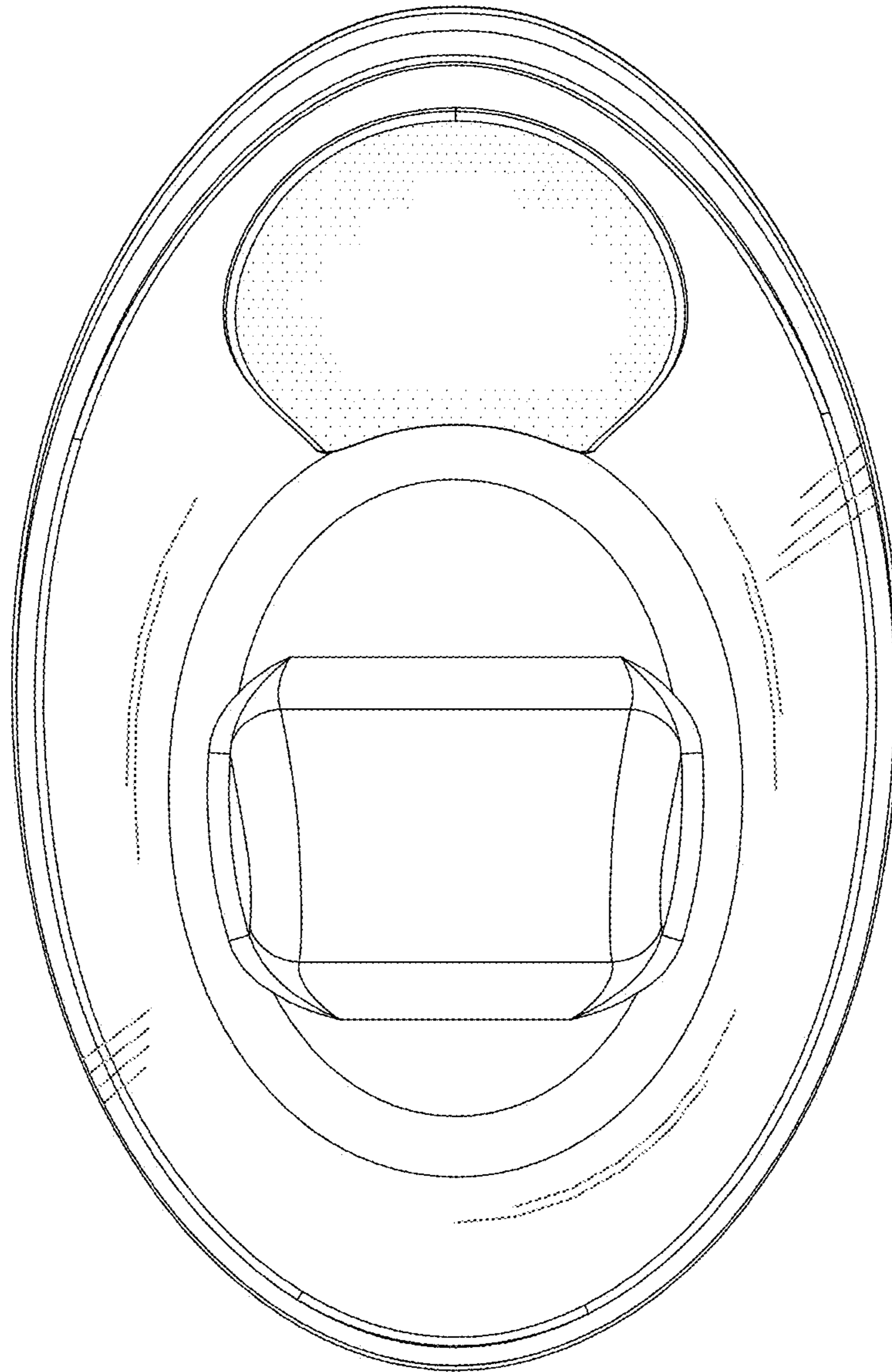

FIG. 6

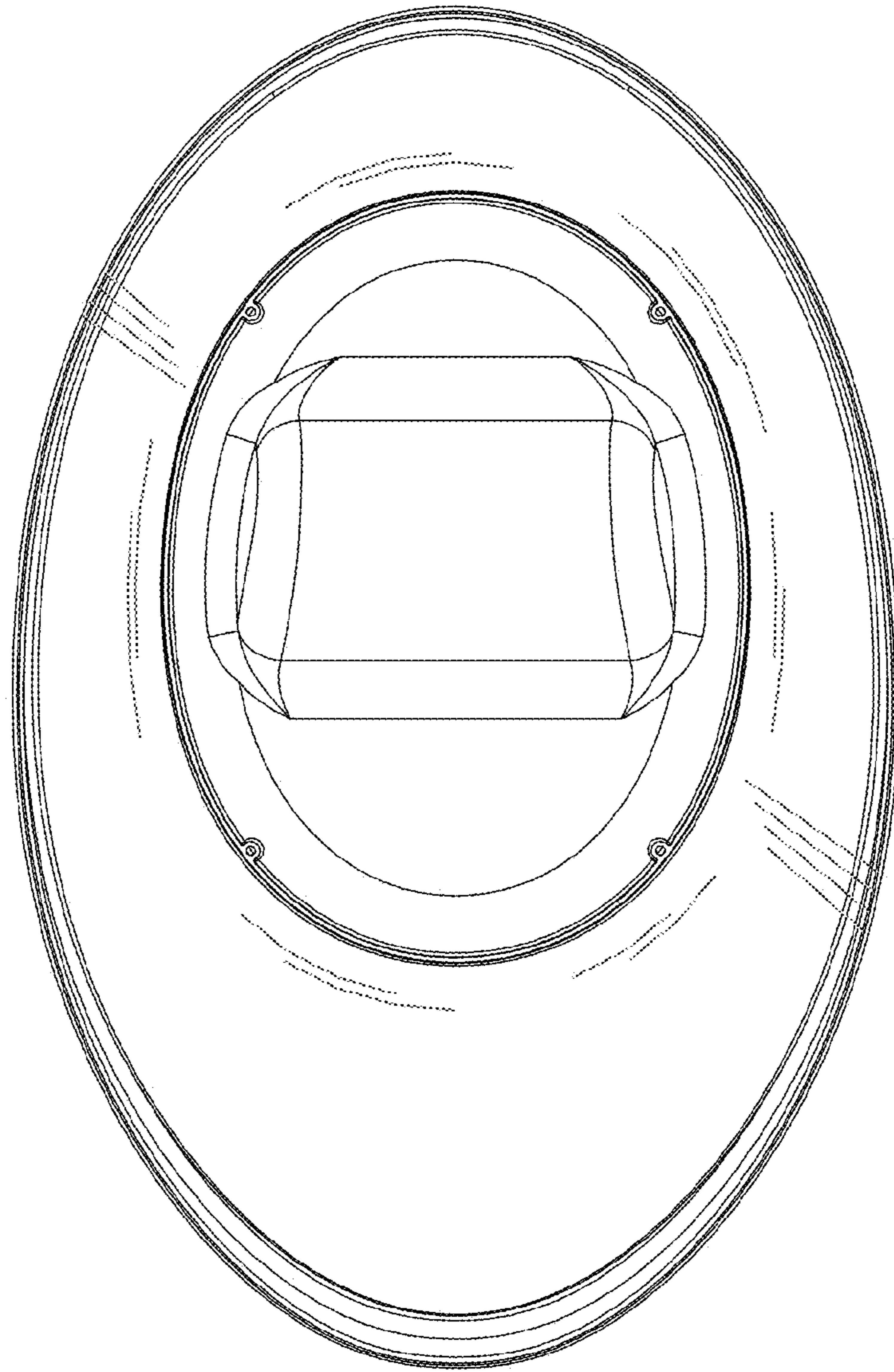

FIG. 7

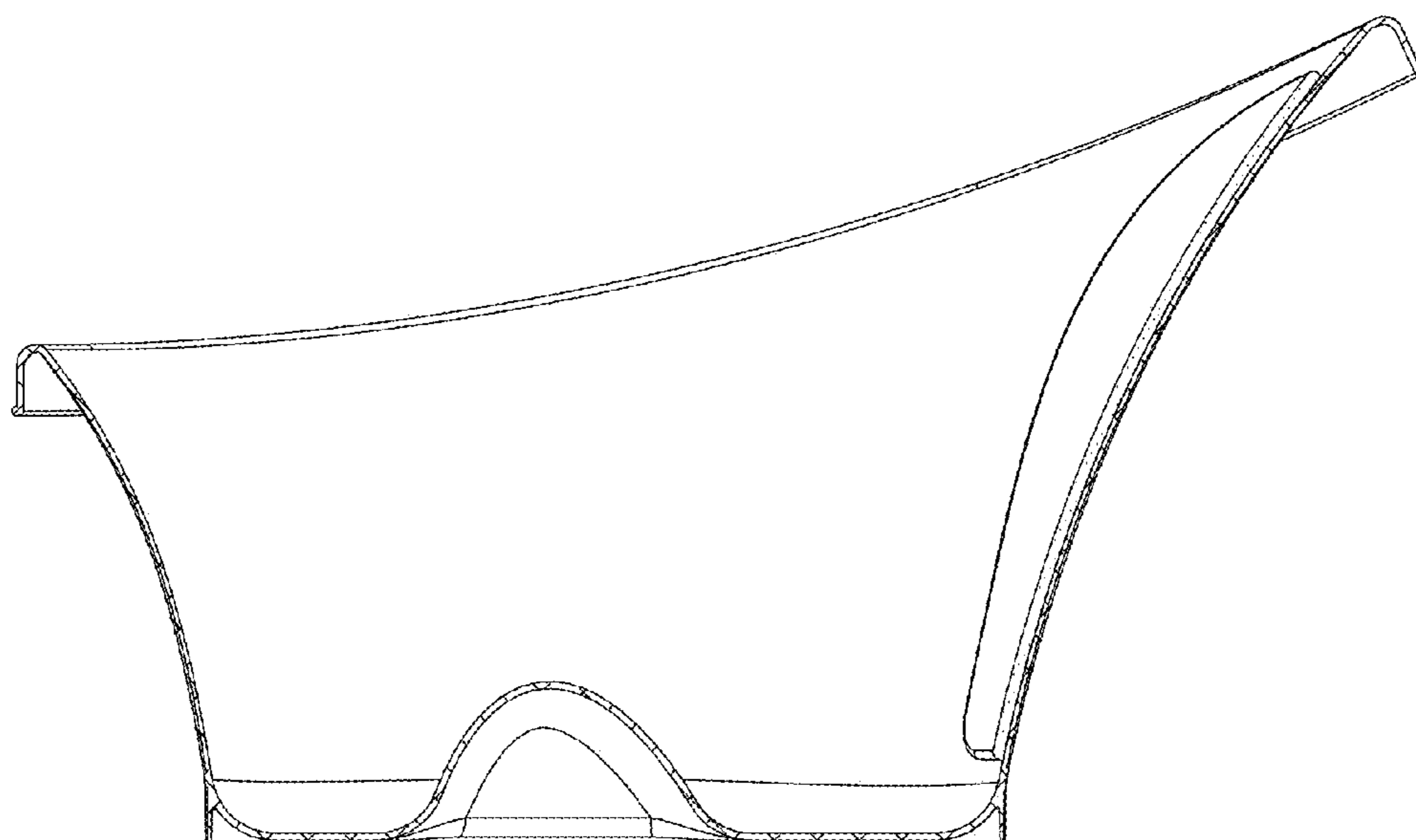

FIG. 8