



US00D724590S

(12) **United States Design Patent**
Hwang

(10) **Patent No.:** **US D724,590 S**
(45) **Date of Patent:** **** Mar. 17, 2015**

(54) **MOUSE**

(71) Applicant: **Samsung Electronics Co., Ltd.**,
Suwon-si (KR)

(72) Inventor: **Ji-Woong Hwang**, Seoul (KR)

(73) Assignee: **Samsung Electronics Co., Ltd.** (KR)

(**) Term: **14 Years**

(21) Appl. No.: **29/500,122**

(22) Filed: **Aug. 21, 2014**

(30) **Foreign Application Priority Data**

Feb. 21, 2014 (KR) 30-2014-0008936

(51) **LOC (10) Cl.** **14-02**

(52) **U.S. Cl.**
USPC **D14/408**

(58) **Field of Classification Search**
USPC D14/402-411, 356, 388, 389, 383-385,
D14/417, 426; 345/156-167; 463/36-38;
358/471, 473; 273/148 B
See application file for complete search history.

(56) **References Cited**

U.S. PATENT DOCUMENTS

D330,706 S * 11/1992 San-Yih D14/408
D454,568 S * 3/2002 Andre et al. D14/408
D493,173 S * 7/2004 Canavan et al. D14/408
D607,456 S * 1/2010 Reed et al. D14/408

D622,725 S * 8/2010 Reed et al. D14/408
D629,804 S * 12/2010 Hoehn et al. D14/408
D651,604 S * 1/2012 Fischer D14/408
D657,359 S * 4/2012 Kujawski et al. D14/402
D657,360 S * 4/2012 Kujawski et al. D14/402
D658,650 S * 5/2012 Kujawski et al. D14/402
D667,009 S * 9/2012 Kujawski et al. D14/408
D676,849 S * 2/2013 Kujawski et al. D14/408
D688,243 S * 8/2013 Widiaman et al. D14/408
D688,244 S * 8/2013 Widiaman D14/408
D689,494 S * 9/2013 Widiaman et al. D14/408

* cited by examiner

Primary Examiner — Austin Murphy

(74) *Attorney, Agent, or Firm* — Cantor Colburn LLP

(57) **CLAIM**

The ornamental design for a mouse, as shown and described.

DESCRIPTION

FIG. 1 is a perspective view of a mouse, showing my new design;
FIG. 2 is a front view thereof;
FIG. 3 is a rear view thereof;
FIG. 4 is a side view thereof;
FIG. 5 is another side view thereof;
FIG. 6 is a top view thereof; and,
FIG. 7 is a bottom view thereof.
The broken lines are for environmental purpose only and form no part of the claimed design. Bold type dashed lines showing a sewing line form part of the claimed design.

1 Claim, 5 Drawing Sheets

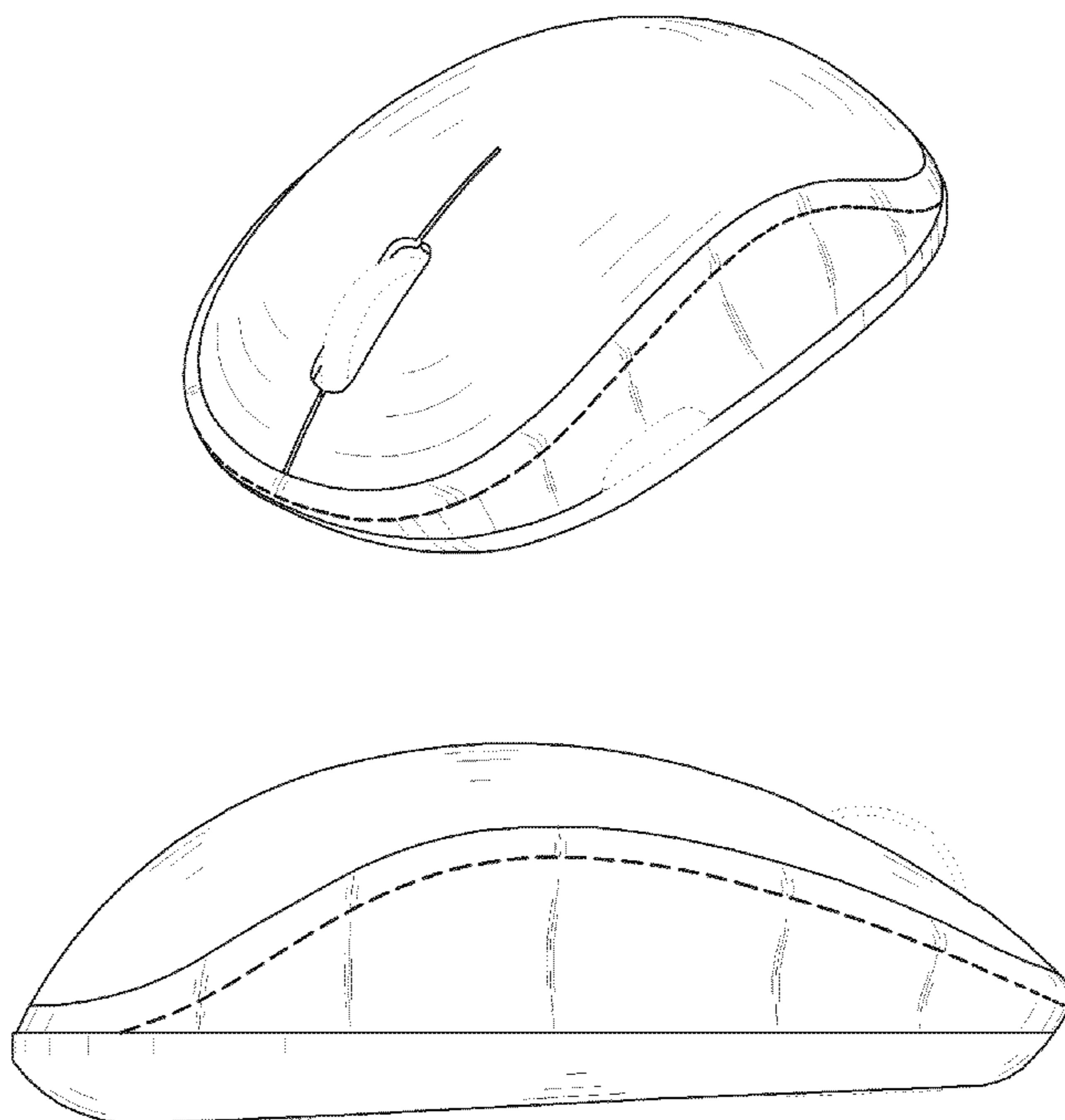

FIG. 1

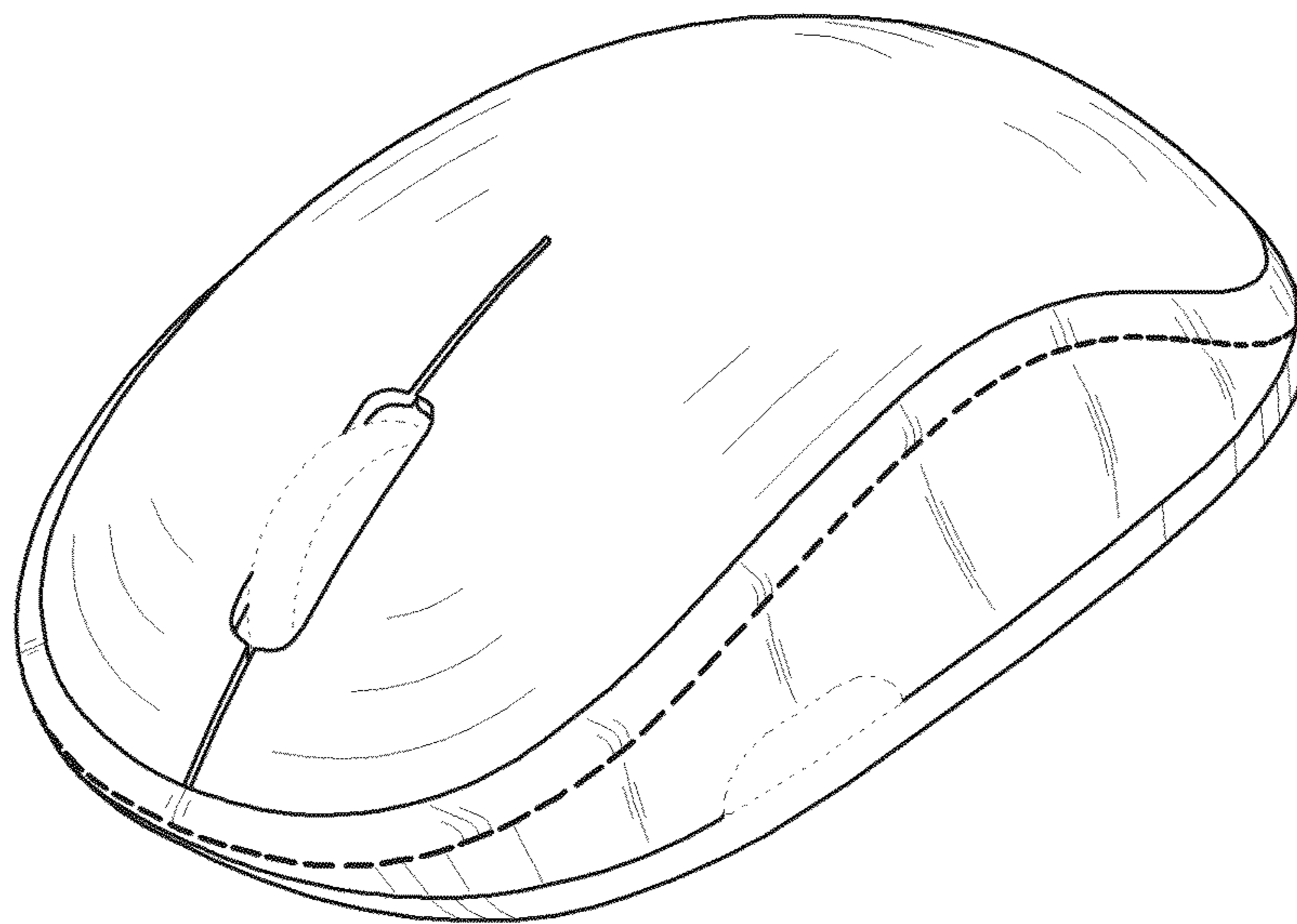

FIG. 2

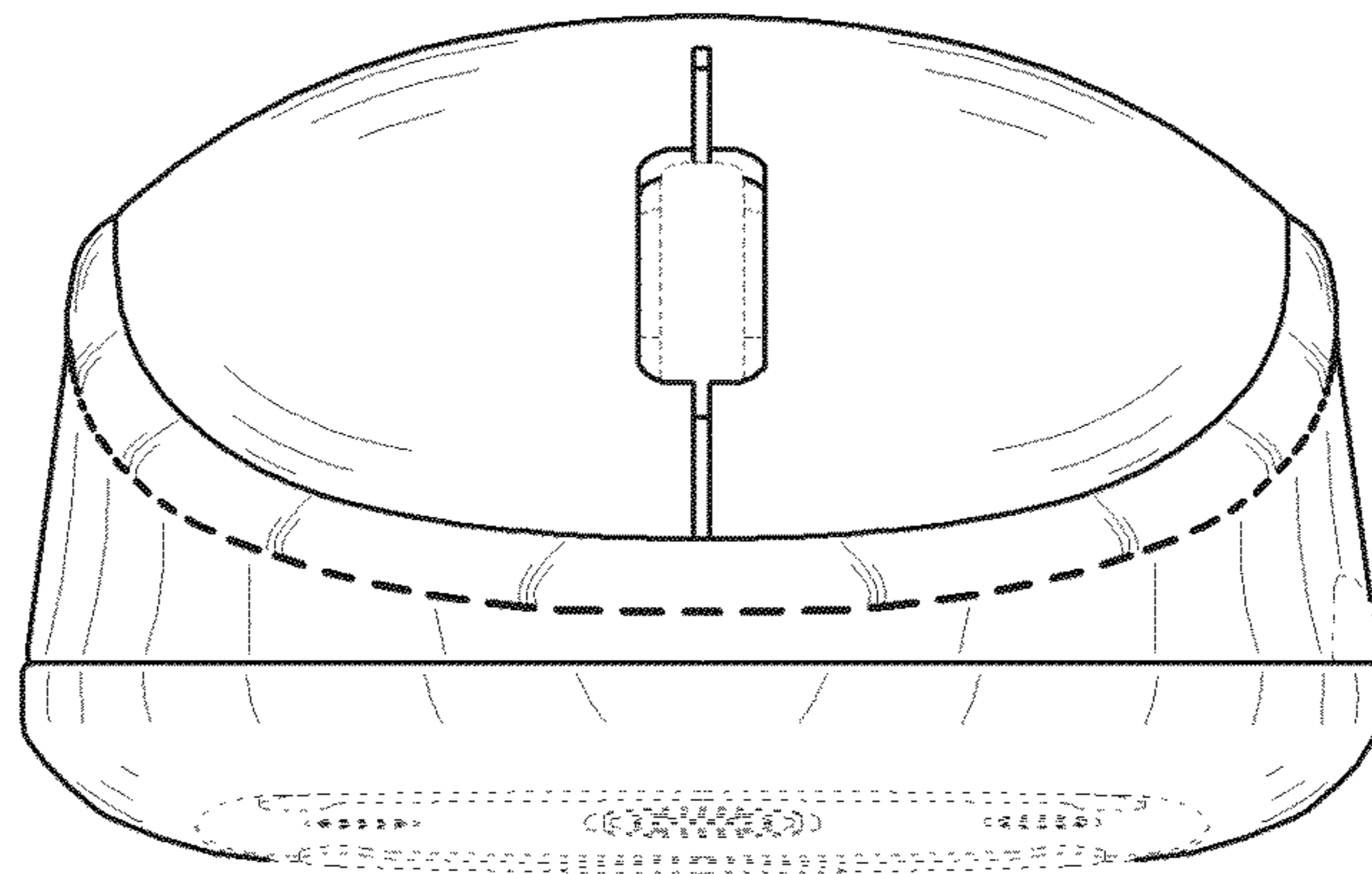

FIG. 3

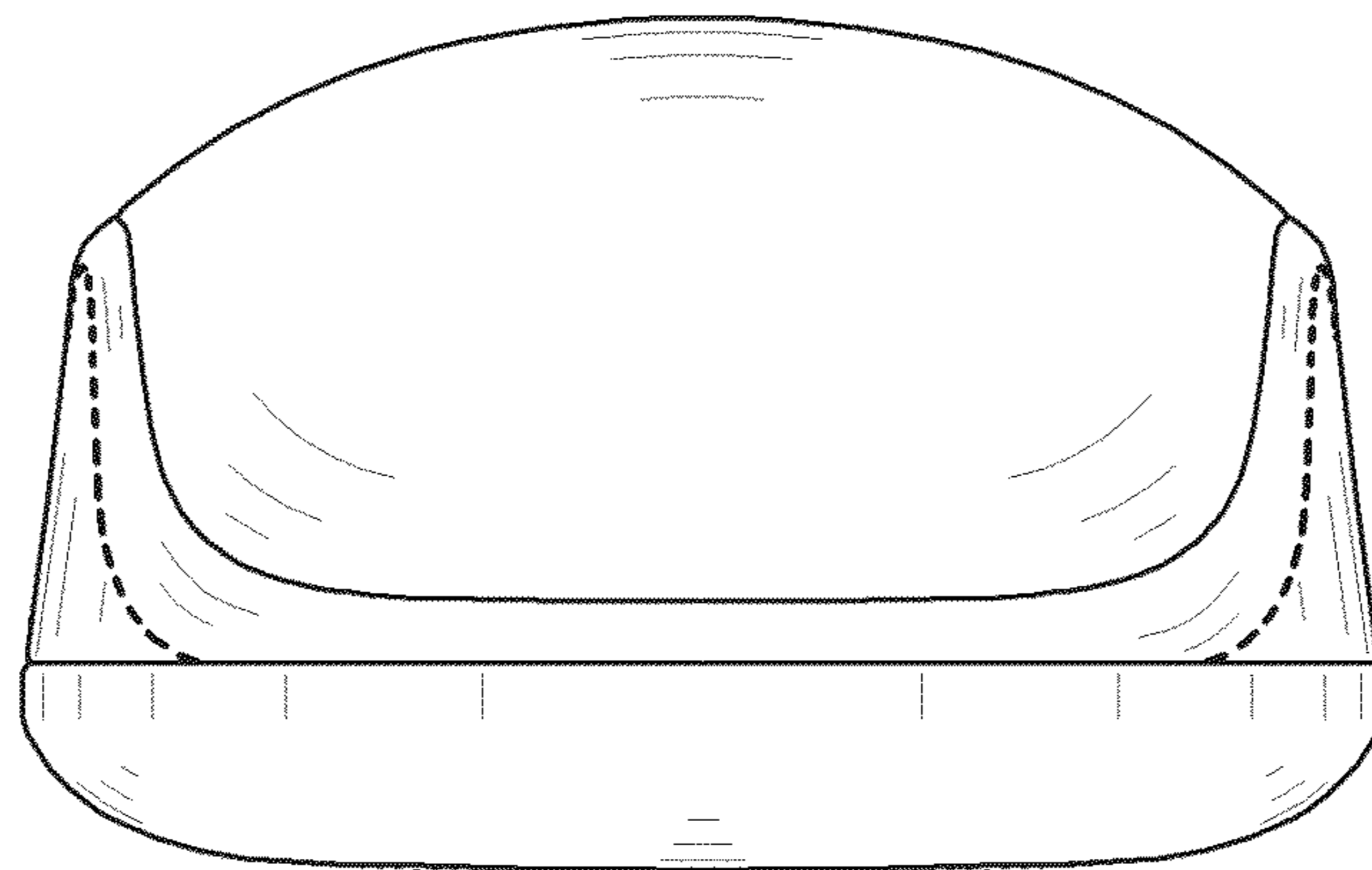

FIG. 4

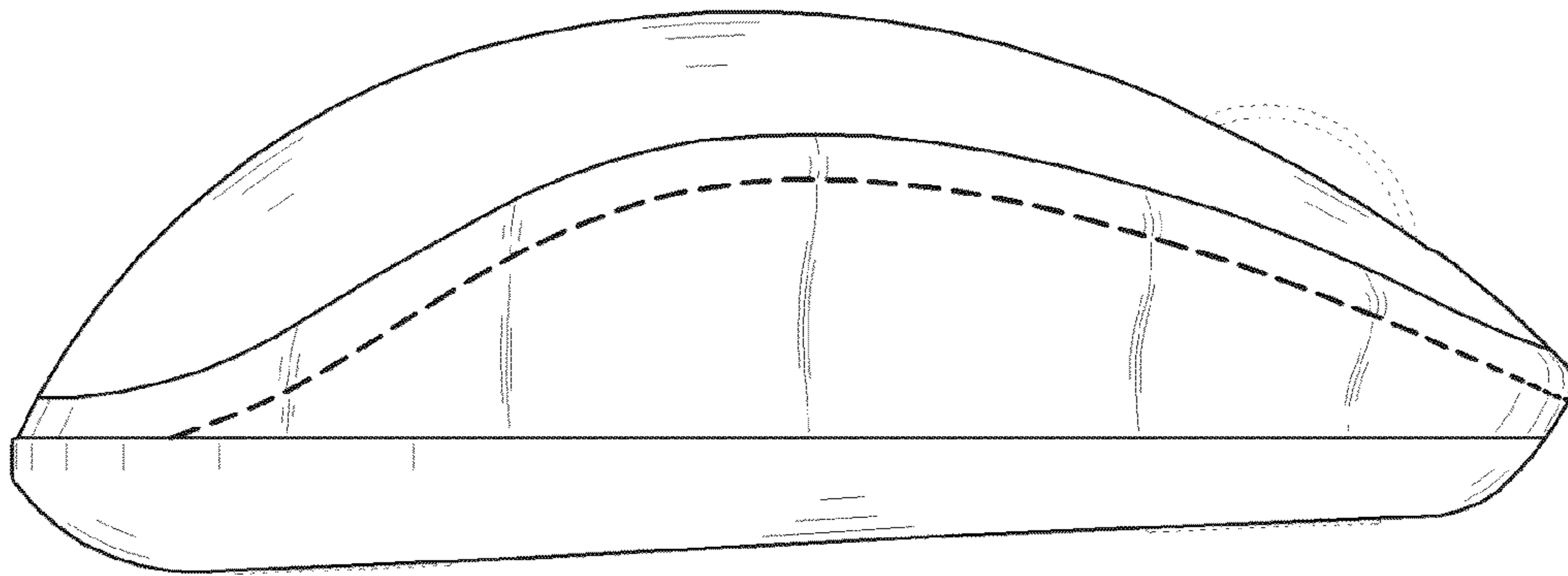

FIG. 5

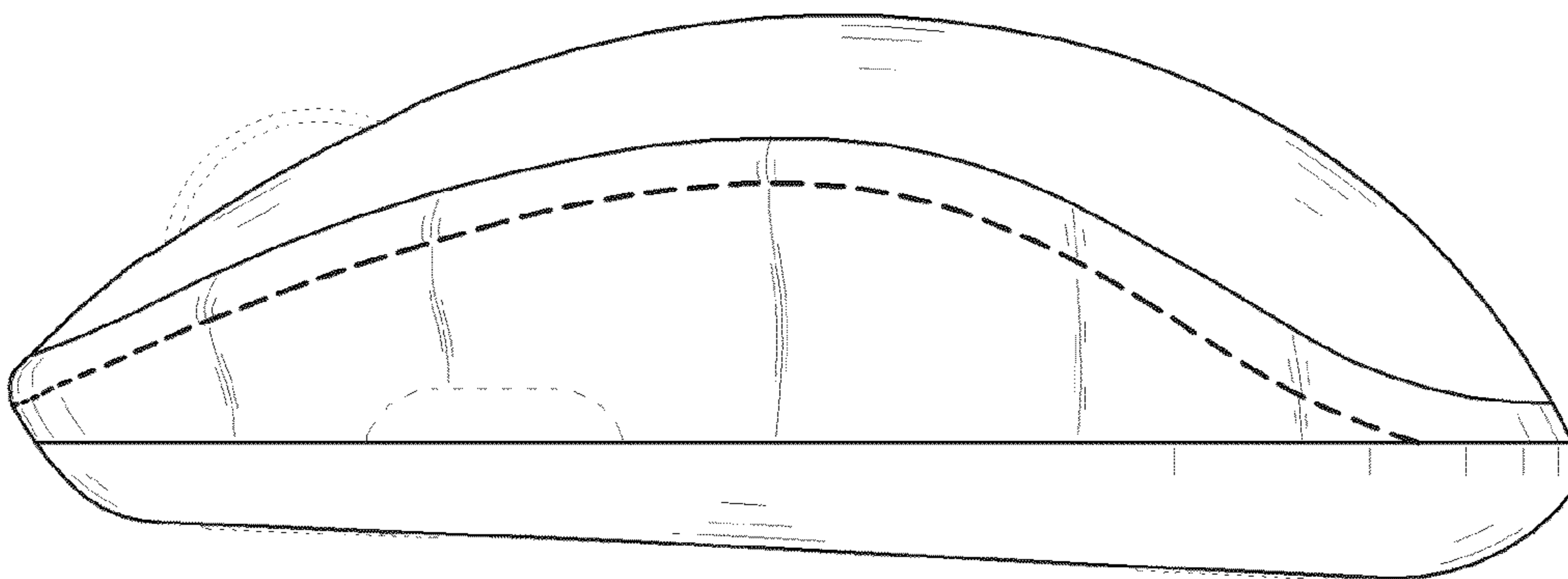

FIG. 6

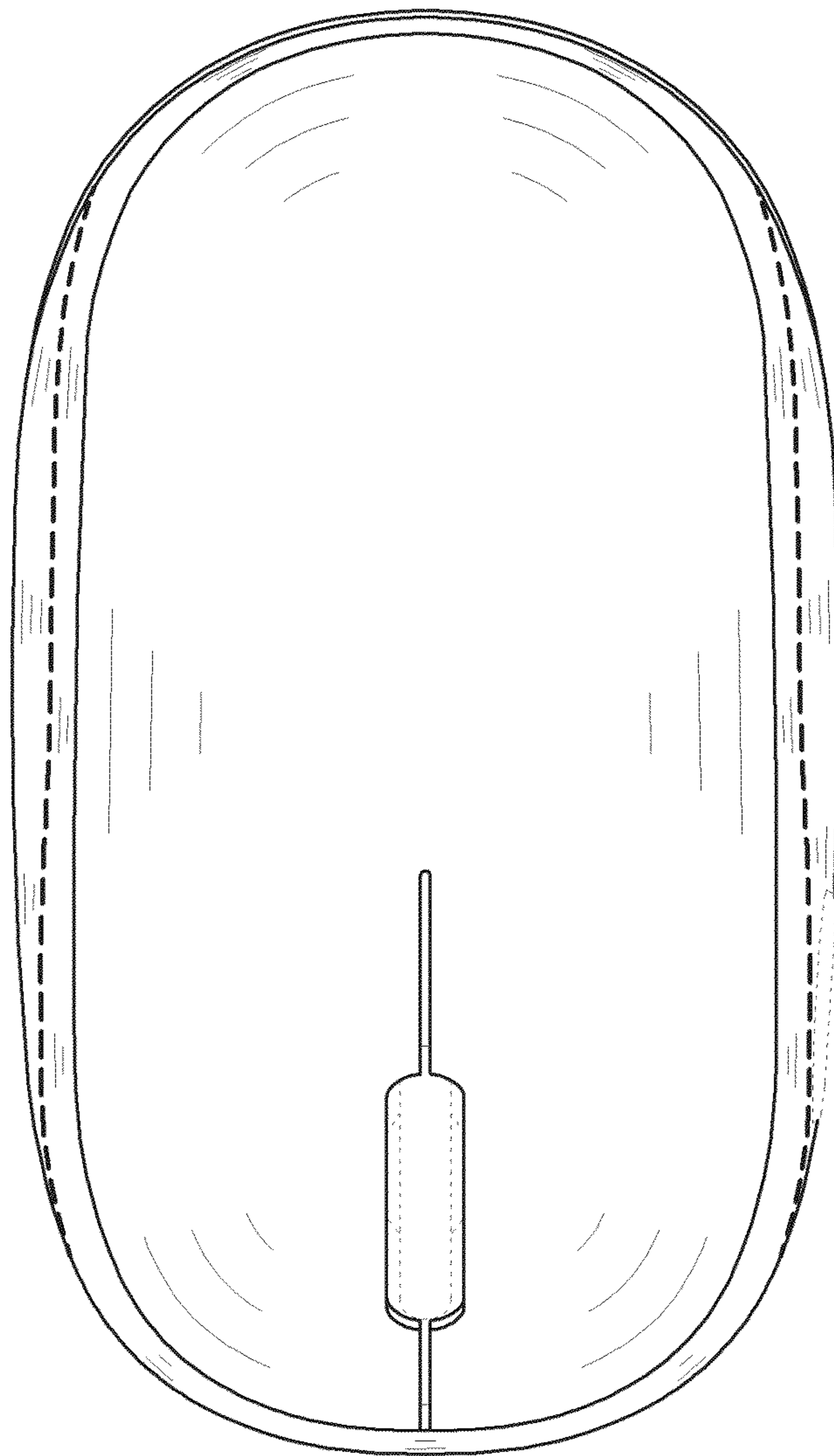

FIG. 7

