



US00D724584S

(12) **United States Design Patent**
Yagi

(10) **Patent No.:** **US D724,584 S**
(45) **Date of Patent:** **** Mar. 17, 2015**

(54) **DISPLAY**

(71) Applicant: **Funai Electric Co., Ltd.**, Osaka (JP)

(72) Inventor: **Hidekazu Yagi**, Osaka (JP)

(73) Assignee: **Funai Electric Co., Ltd.**, Osaka (JP)

(**) Term: **14 Years**

(21) Appl. No.: **29/457,828**

(22) Filed: **Jun. 13, 2013**

(30) **Foreign Application Priority Data**

May 16, 2013 (JP) 2013-010813

(51) **LOC (10) Cl.** **14-02**

(52) **U.S. Cl.**
USPC **D14/371**

(58) **Field of Classification Search**
USPC D14/371-375, 125-129, 336, 337;
341/12; 345/104, 156, 168, 173;
348/180, 184, 325, 739; 349/1, 2, 11,
349/62; 361/679.05-679.07, 679.21;
D6/300, 308
See application file for complete search history.

(56) **References Cited**

U.S. PATENT DOCUMENTS

D458,238 S * 6/2002 Niitsu D14/126
D600,695 S * 9/2009 Niitsu et al. D14/371

D606,503 S * 12/2009 Suzuki D14/126
D678,853 S * 3/2013 Kim et al. D14/126

* cited by examiner

Primary Examiner — Freda S Nunn

(74) *Attorney, Agent, or Firm* — Morgan, Lewis & Bockius LLP

(57) **CLAIM**

The ornamental design for a display, as shown and described.

DESCRIPTION

FIG. 1 is a rear perspective view of a display having a rear panel composed of an upper panel and a lower panel.

FIG. 2 is a front view of the display.

FIG. 3 is a rear view of the display.

FIG. 4 is a right side view of the display.

FIG. 5 is a left side view of the display.

FIG. 6 is a plan view of the display.

FIG. 7 is a bottom view of the display.

FIG. 8 is a rear view of the upper panel constituting the rear panel.

FIG. 9 is a rear view of the lower panel constituting the rear panel; and,

FIG. 10 is a partly enlarged sectional view of part A-A'/B-B' in FIG. 3, with the inner structure omitted.

The long-dash short-dash lines shown in FIGS. 1, 3, 4, 5, 8, 9 and 10 that are immediately above and below the solid lines on the rear of the display represent the bounds of the claimed design, while the broken lines are directed to environment and form no part of the claimed design.

1 Claim, 5 Drawing Sheets

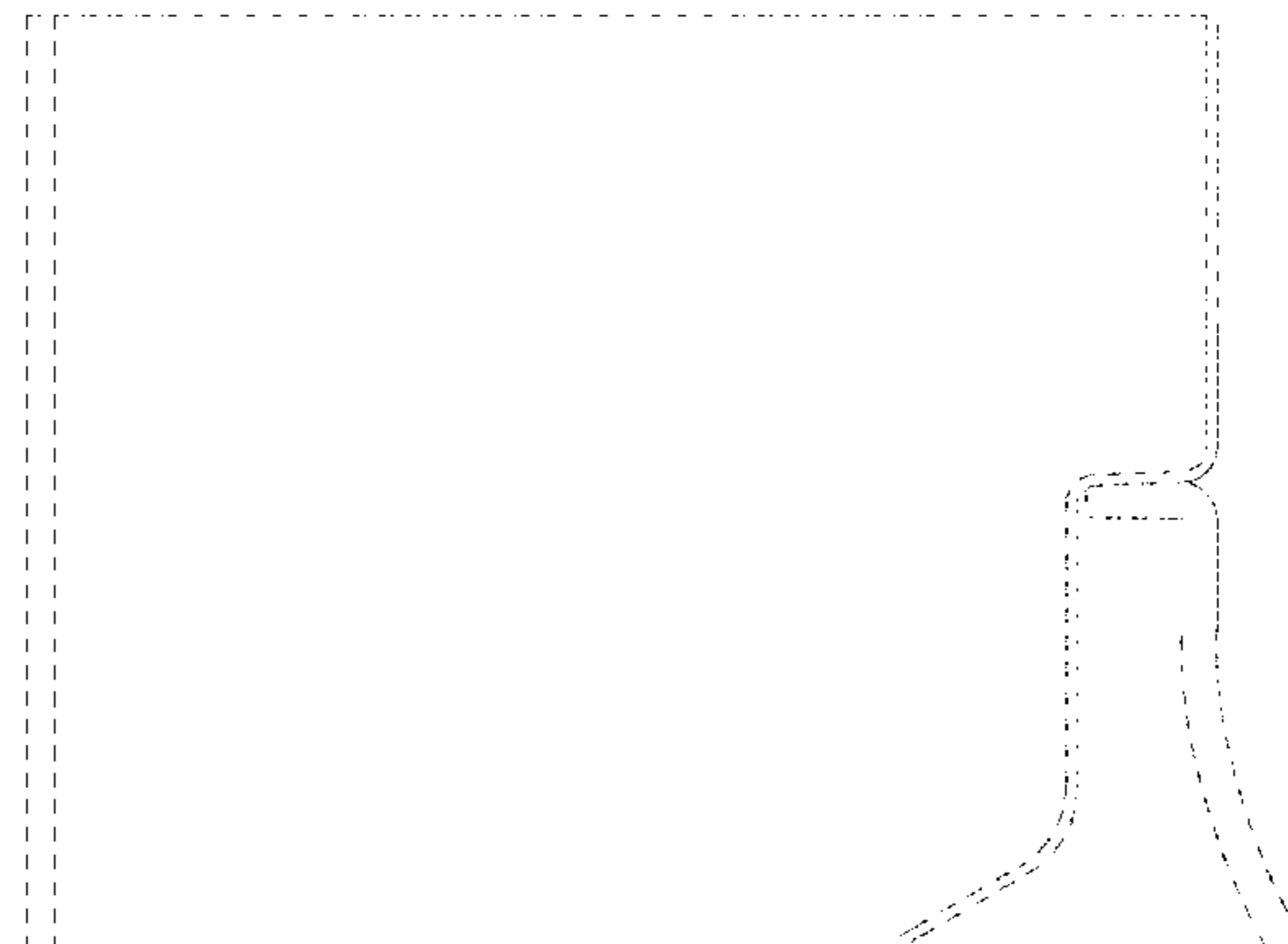
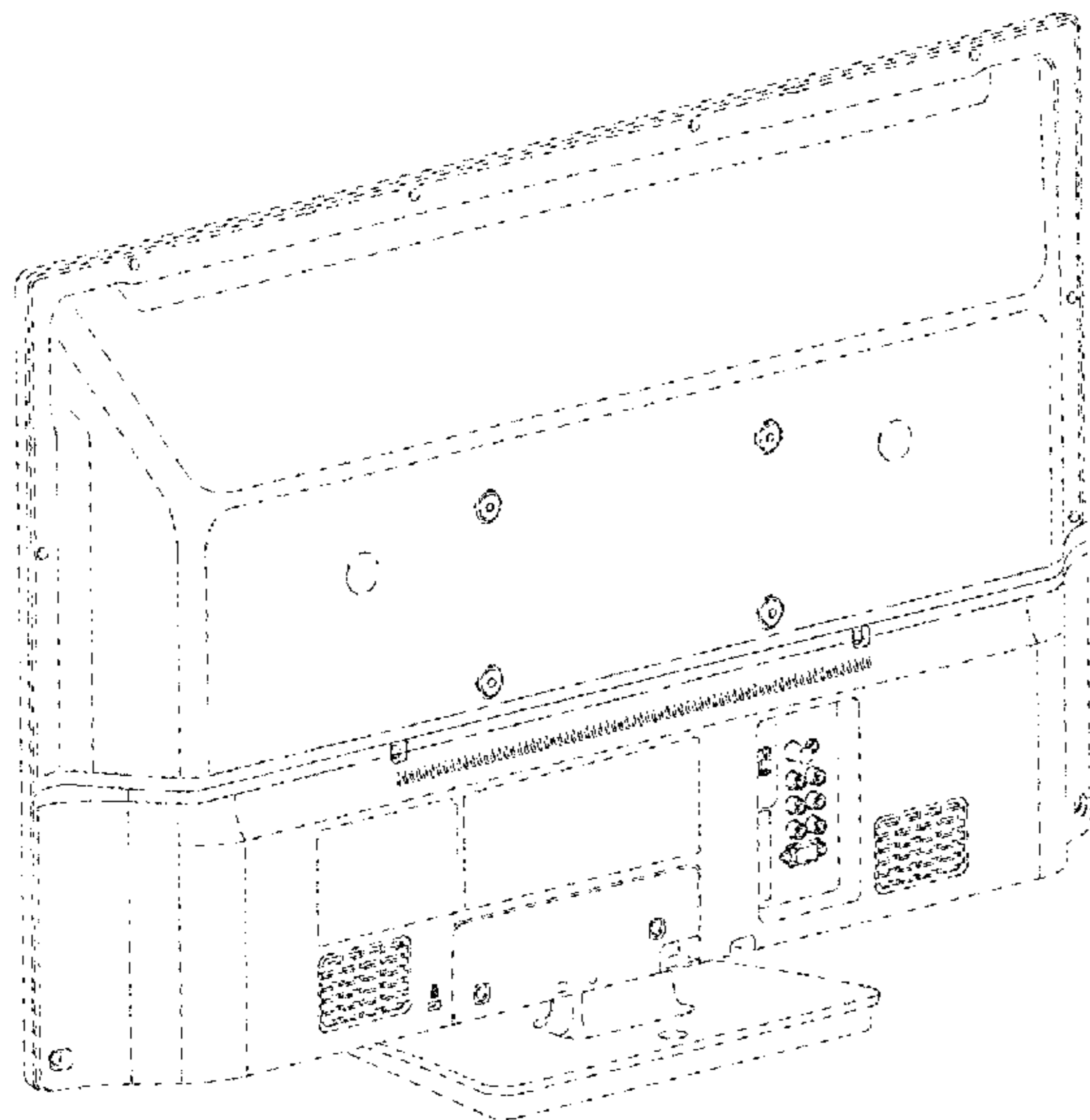

Fig01

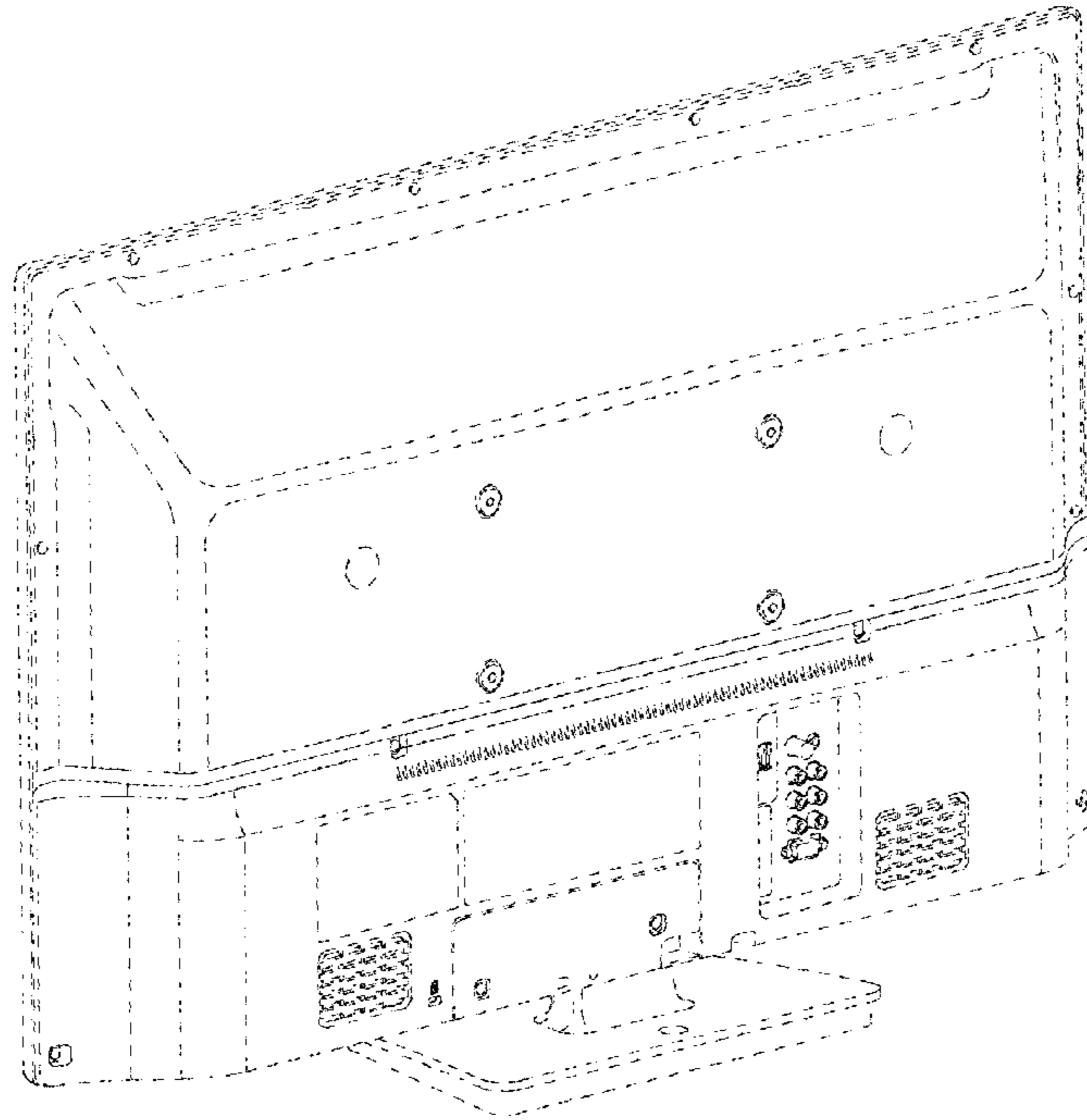

Fig02



Fig03

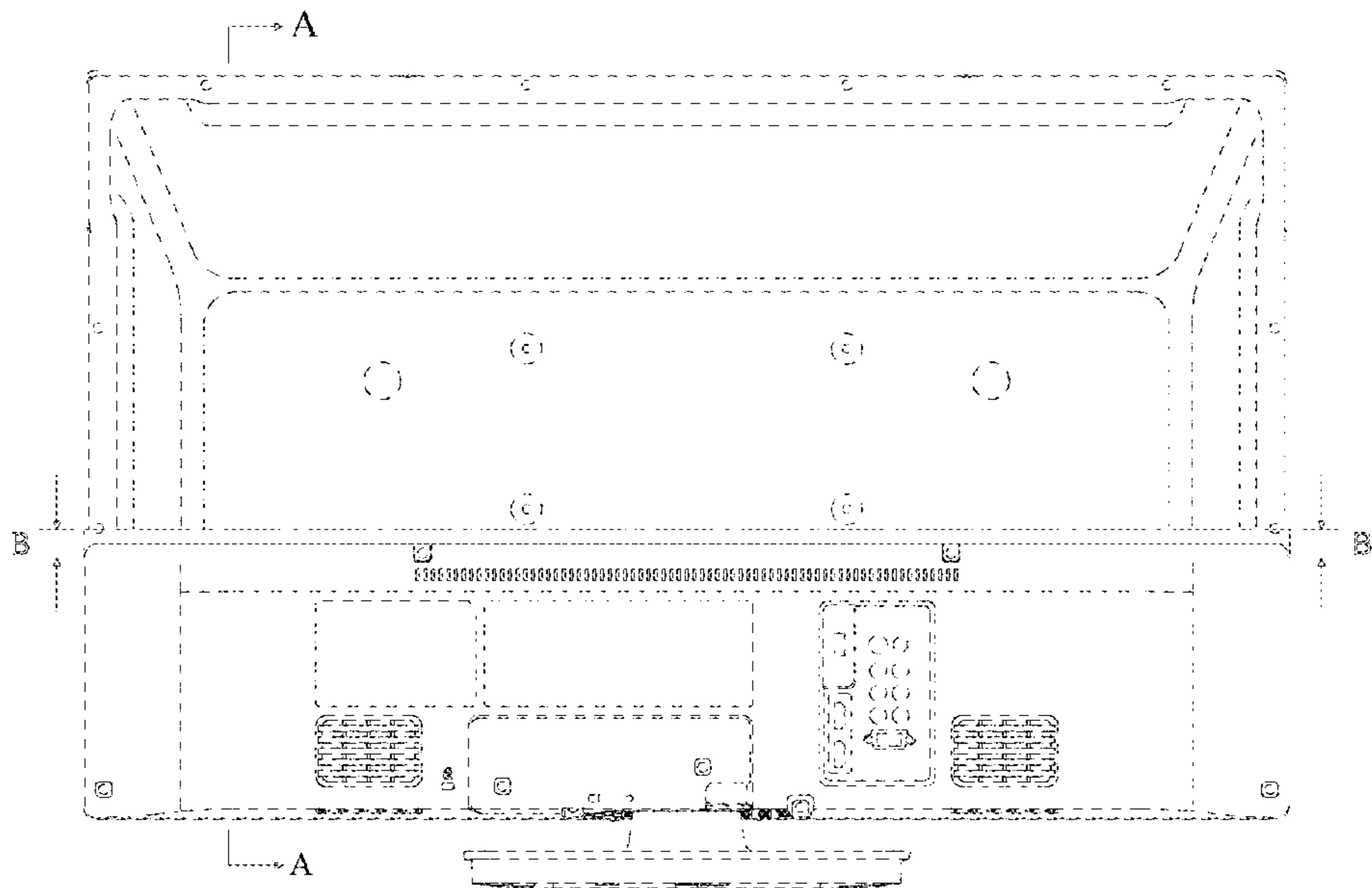

Fig04

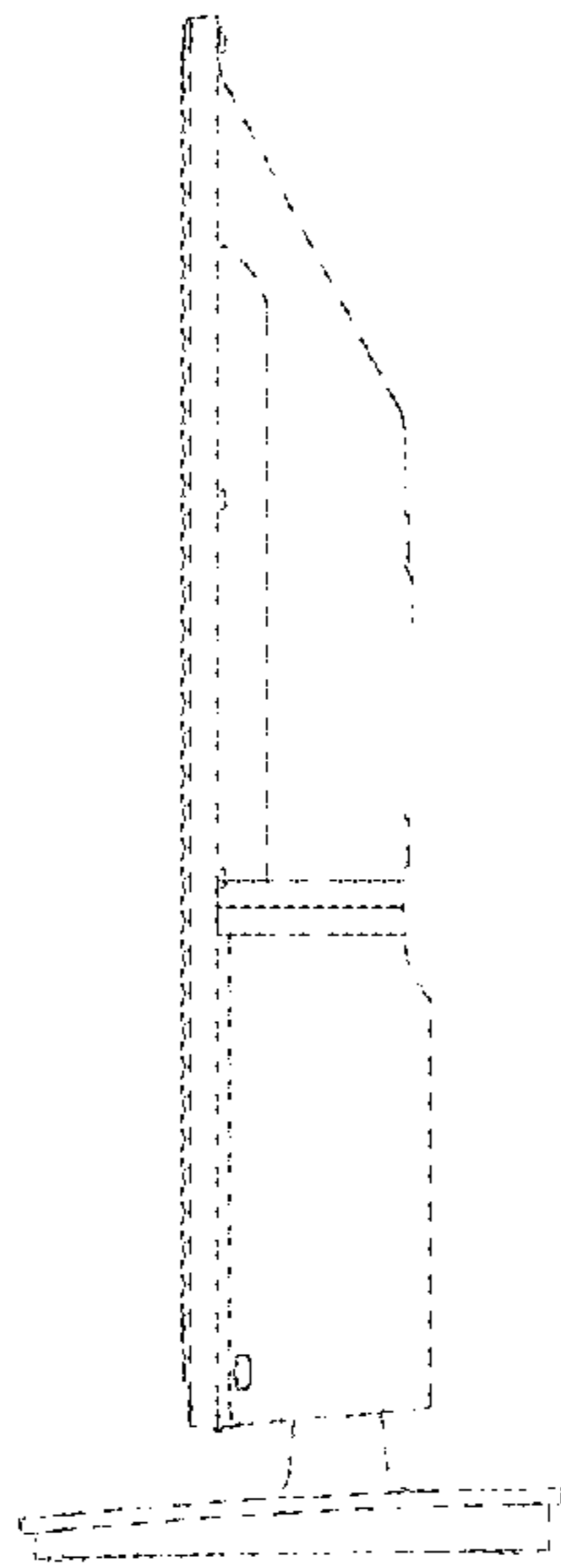

Fig05

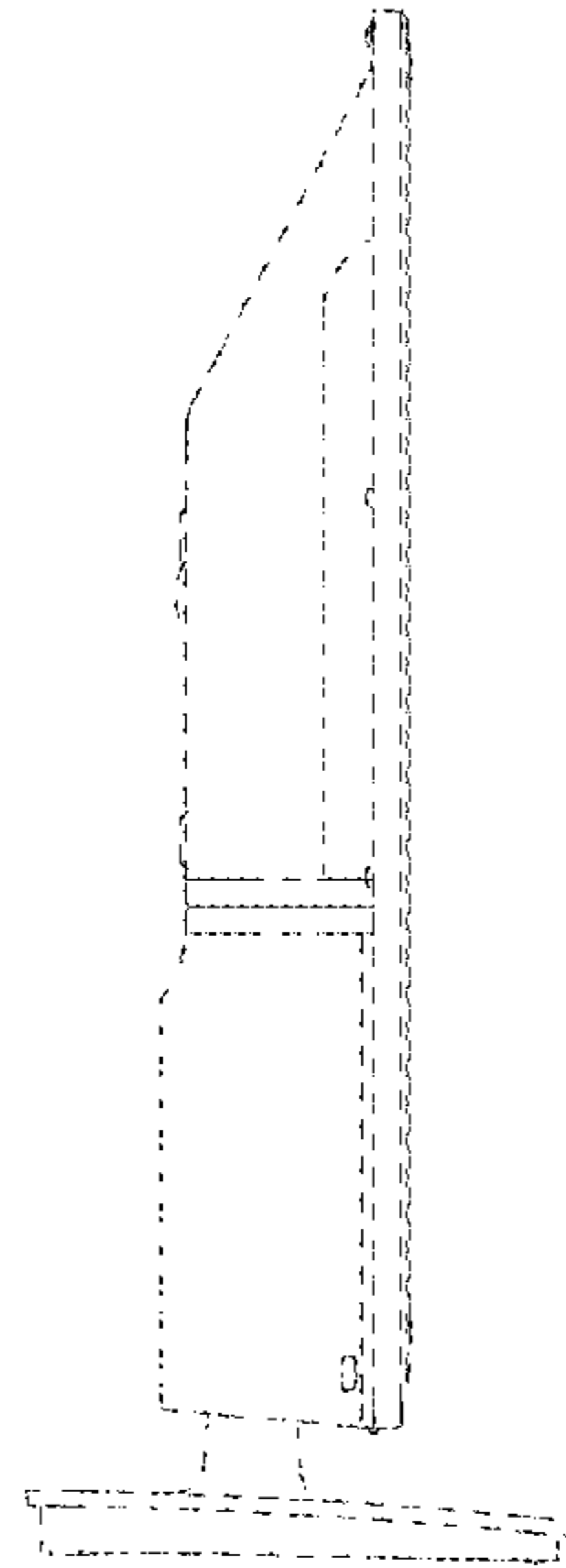

Fig06

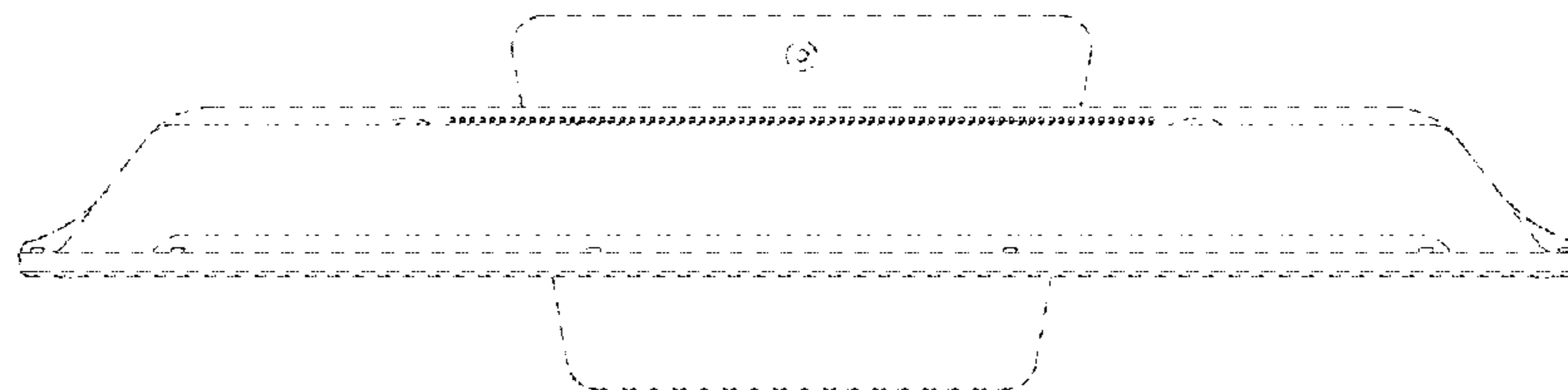

Fig07

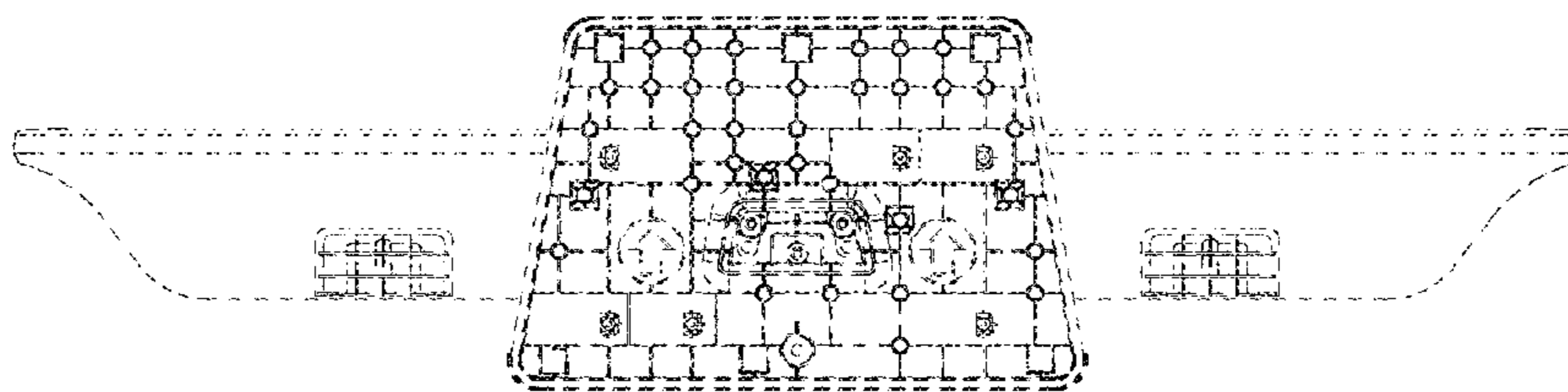

Fig08

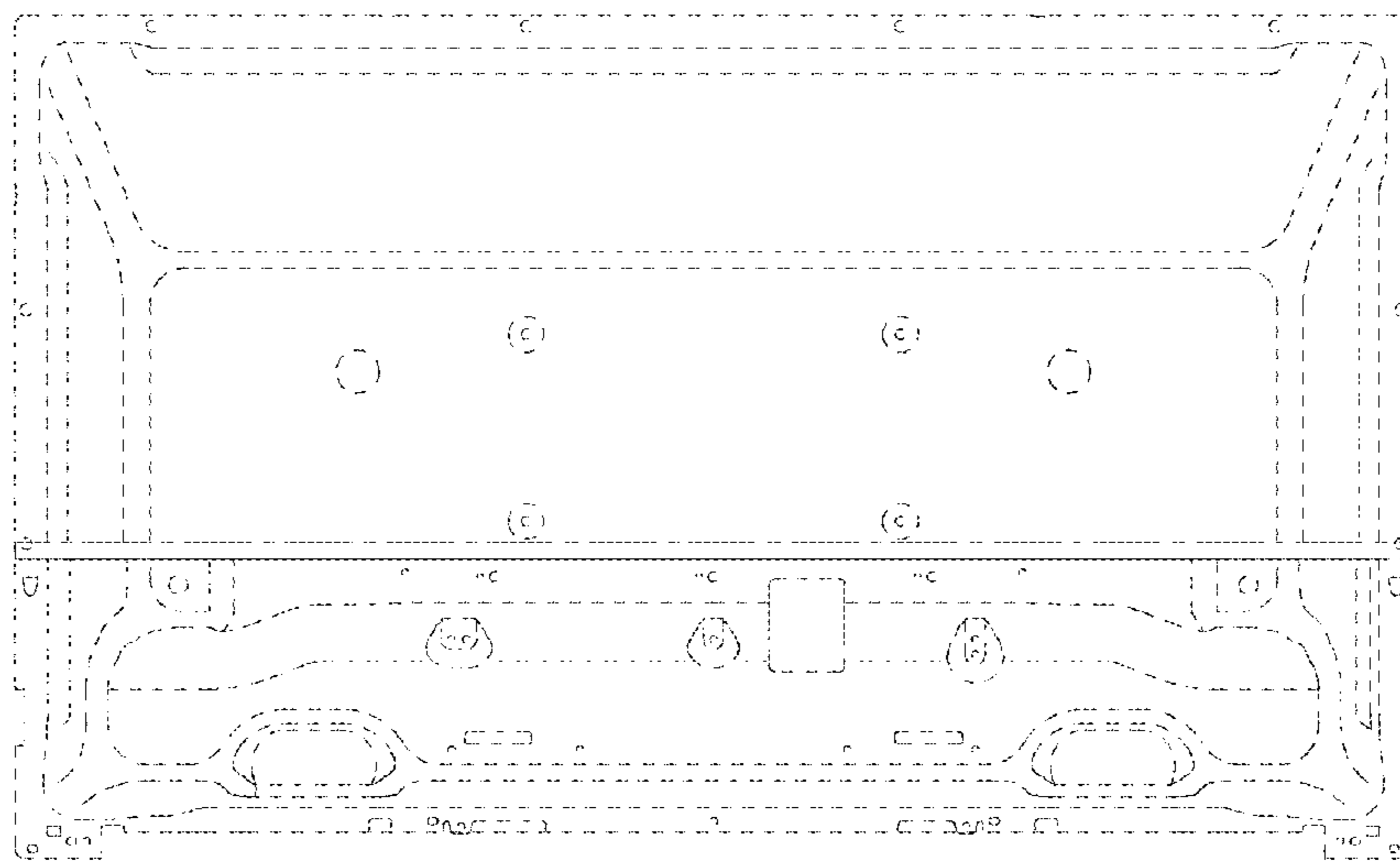

Fig09

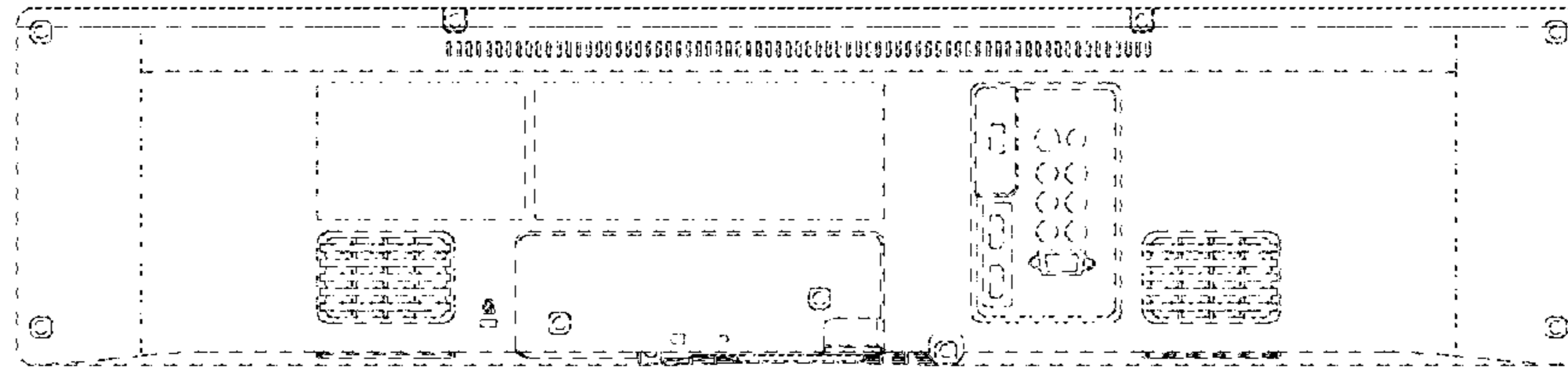

Fig10

