



US00D724575S

(12) **United States Design Patent**
Murakami

(10) **Patent No.:** **US D724,575 S**
(45) **Date of Patent:** **** Mar. 17, 2015**

- (54) **AUDIO PLAYER**
- (71) Applicant: **Sony Corporation**, Tokyo (JP)
- (72) Inventor: **Tomonari Murakami**, Chiba (JP)
- (73) Assignee: **Sony Corporation**, Tokyo (JP)
- (**) Term: **14 Years**
- (21) Appl. No.: **29/478,488**
- (22) Filed: **Jan. 6, 2014**

(30) **Foreign Application Priority Data**

Jul. 8, 2013 (CN) 2013 3 0314559

(51) **LOC (10) Cl.** **14-03**

(52) **U.S. Cl.**
USPC **D14/258**; D14/498; D14/157

(58) **Field of Classification Search**
USPC D14/126, 129, 131–133, 203.1, 203.4,
D14/137, 155, 157, 168–171, 188, 194, 197,
D14/198, 239, 257, 258, 496, 498–508;
455/90.1–90.3, 344–355; 369/6–12
See application file for complete search history.

(56) **References Cited**

U.S. PATENT DOCUMENTS

D481,373 S	10/2003	Sogabe	
D539,769 S *	4/2007	Yoshihara et al.	D14/505
D540,288 S *	4/2007	Yoshihara et al.	D14/157
D542,261 S *	5/2007	Uehara et al.	D14/505
D554,087 S *	10/2007	Matsumoto	D14/505
D554,088 S *	10/2007	Matsumoto	D14/505
D563,922 S *	3/2008	Shiono	D14/505
D565,043 S *	3/2008	Shiono	D14/258
D571,348 S *	6/2008	Uehara et al.	D14/157
D571,350 S *	6/2008	Iwamoto et al.	D14/157
D585,403 S *	1/2009	Wada	D14/500
D587,674 S *	3/2009	Uehara et al.	D14/157
D588,156 S *	3/2009	Shiono	D14/505
D602,928 S *	10/2009	Kimura et al.	D14/258
D605,660 S	12/2009	Yagihashi	

D606,097 S *	12/2009	Yokoyama	D14/505
D610,162 S *	2/2010	Shiono et al.	D14/511
D613,764 S	4/2010	Yokoyama et al.	
D638,415 S	5/2011	Yokoyama	
D645,464 S *	9/2011	Kimura	D14/257
D671,520 S *	11/2012	Kanou	D14/157
D671,906 S *	12/2012	Kimura	D14/157
D689,458 S	9/2013	Yokoyama	
D704,694 S *	5/2014	Takahashi	D14/258
D704,695 S *	5/2014	Kanou	D14/258
D704,696 S *	5/2014	Kimura	D14/258
D705,212 S *	5/2014	Murakami	D14/258

* cited by examiner

Primary Examiner — Keli L Hill

(74) *Attorney, Agent, or Firm* — Rader, Fishman & Grauer PLLC

(57) **CLAIM**

The ornamental design for an audio player, as shown and described.

DESCRIPTION

FIG. 1 is a front, left perspective view of a first embodiment of an audio player showing my new design;
 FIG. 2 is a front top, right perspective view thereof;
 FIG. 3 is a front elevational view thereof;
 FIG. 4 is a left side elevational view thereof;
 FIG. 5 is a top plan view thereof;
 FIG. 6 is a bottom plan view thereof;
 FIG. 7 is a front, left perspective view of a second embodiment of an audio player showing my new design;
 FIG. 8 is a front top, right perspective view thereof;
 FIG. 9 is a left side elevational view thereof;
 FIG. 10 is a front elevational view thereof;
 FIG. 11 is a top plan view thereof; and,
 FIG. 12 is a bottom plan view thereof.
 The dot-dash broken lines immediately adjacent the shaded areas represent the bounds of the claimed design while all other broken lines are included for the purpose of illustrating portions of the audio player; the broken lines form no part of the claimed design.

1 Claim, 12 Drawing Sheets

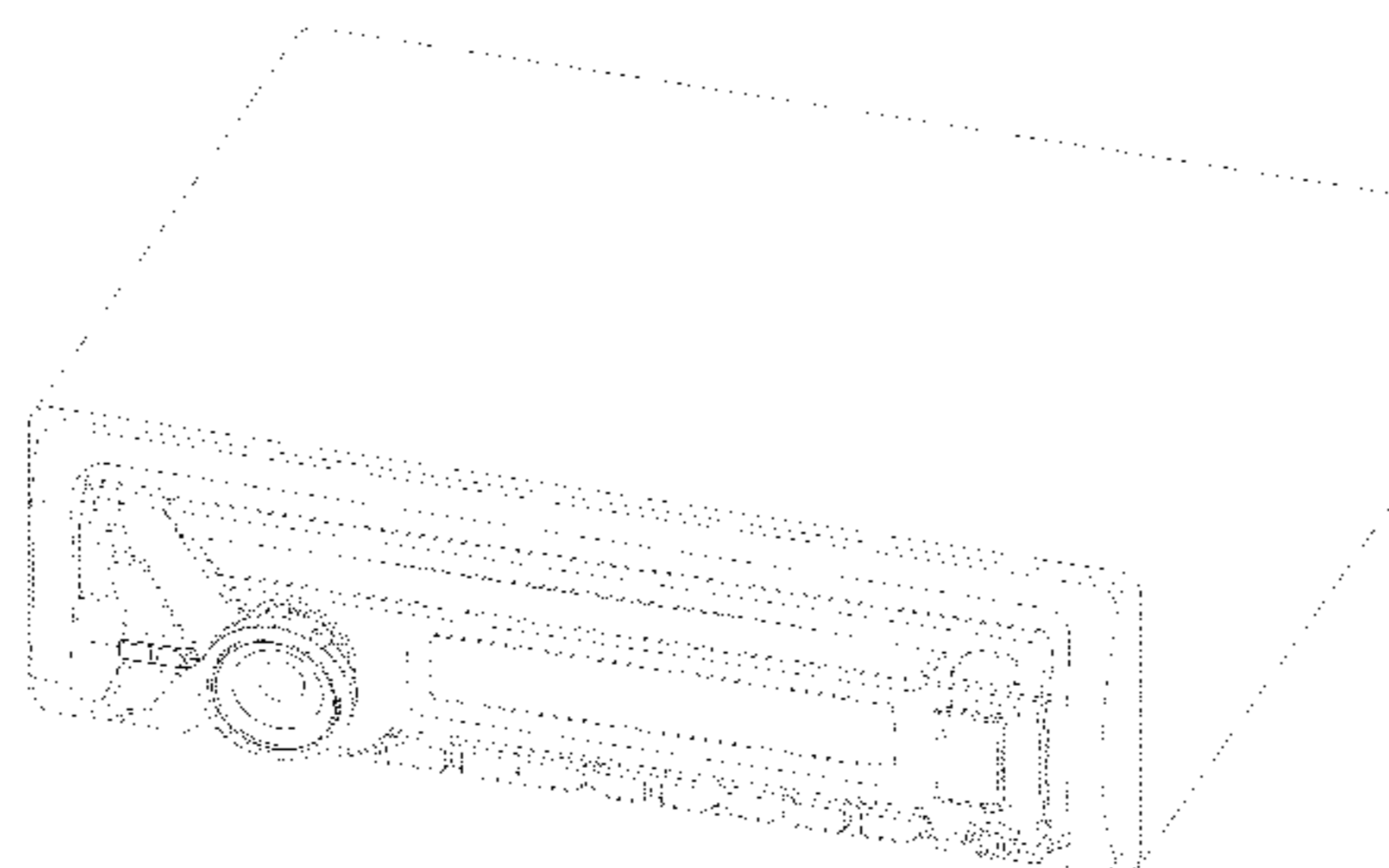
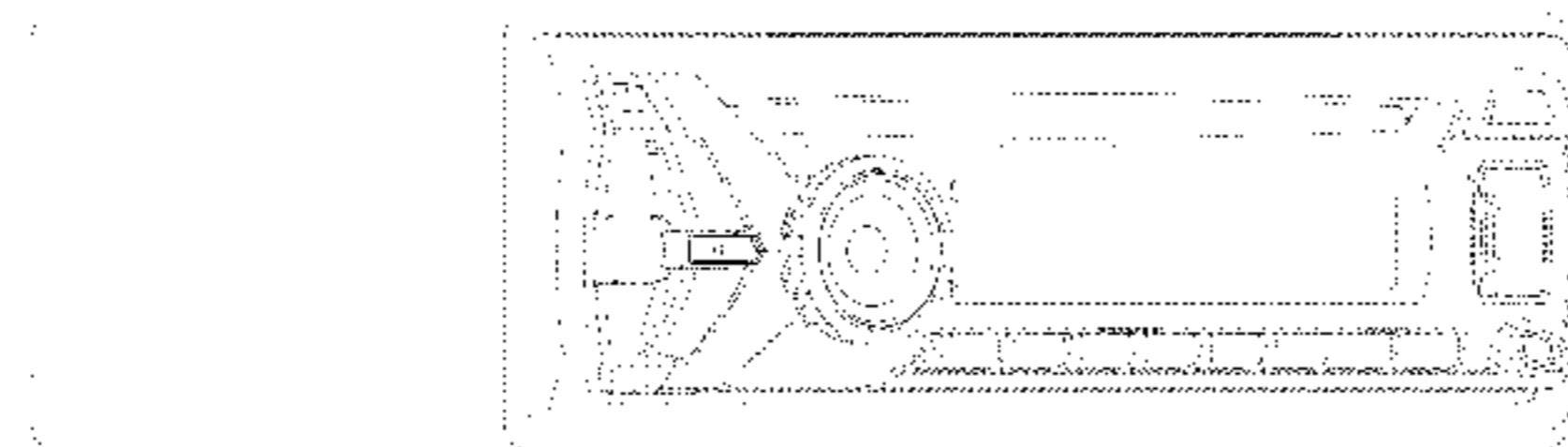

FIG.1

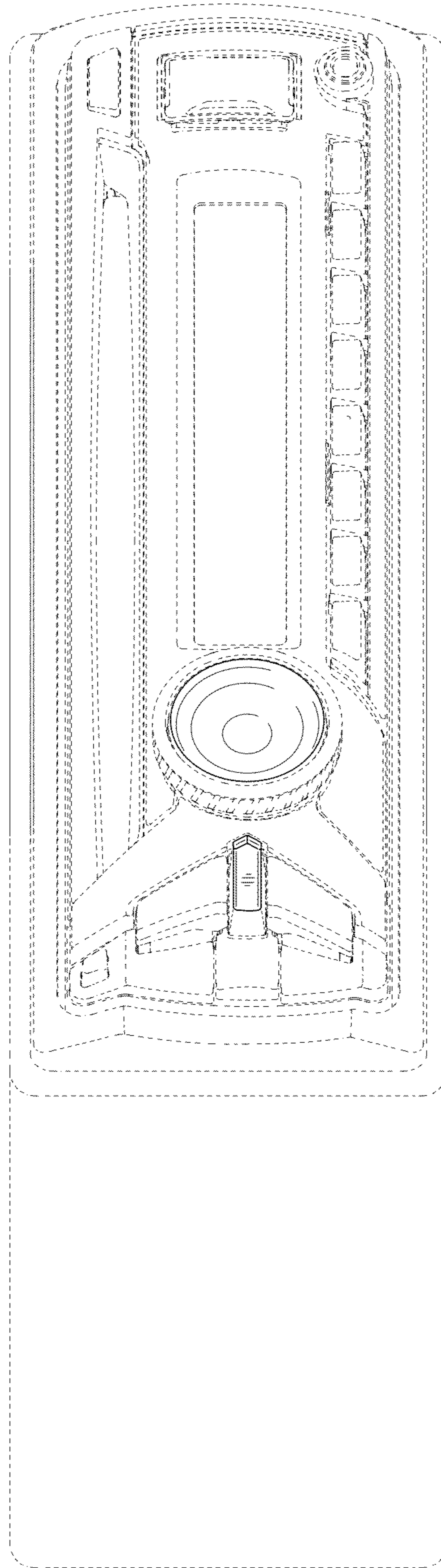

FIG.2

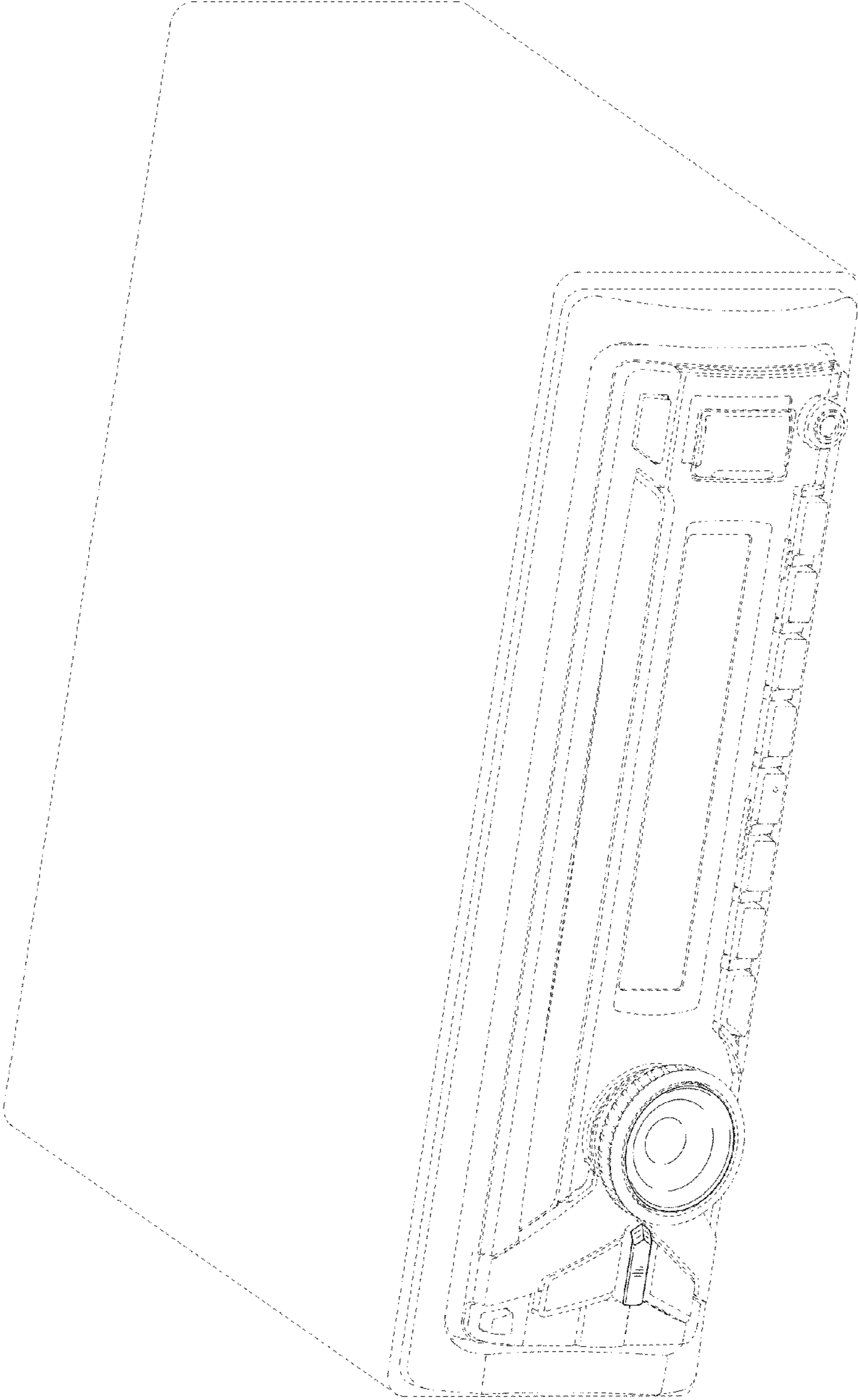

FIG.3

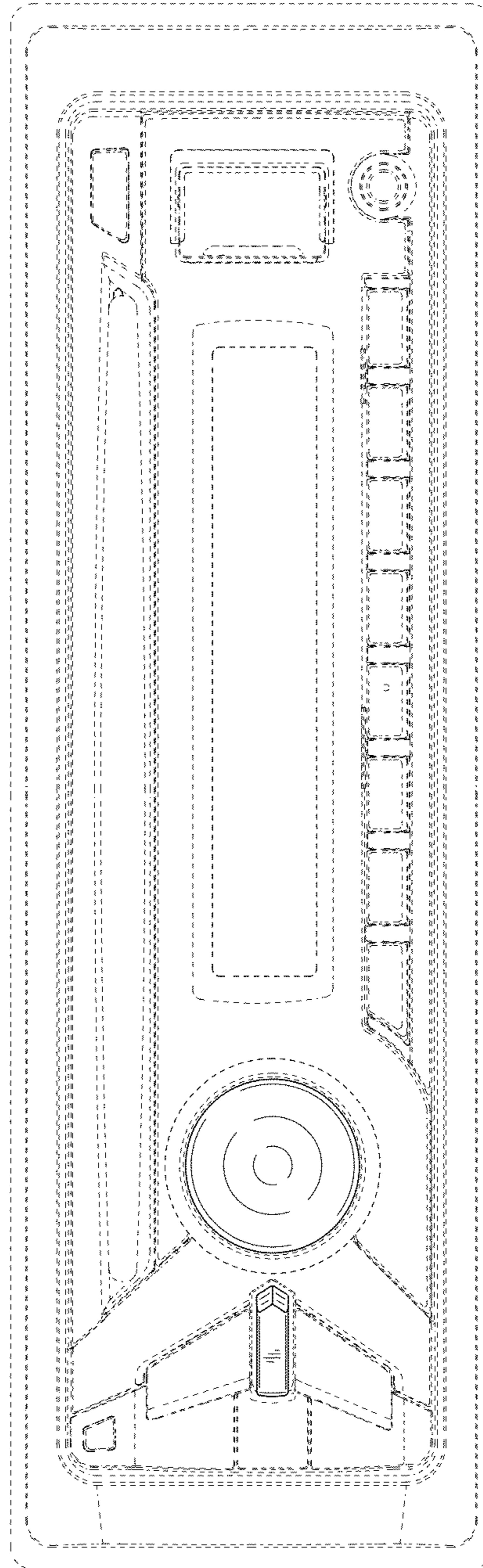

FIG.4



FIG.5

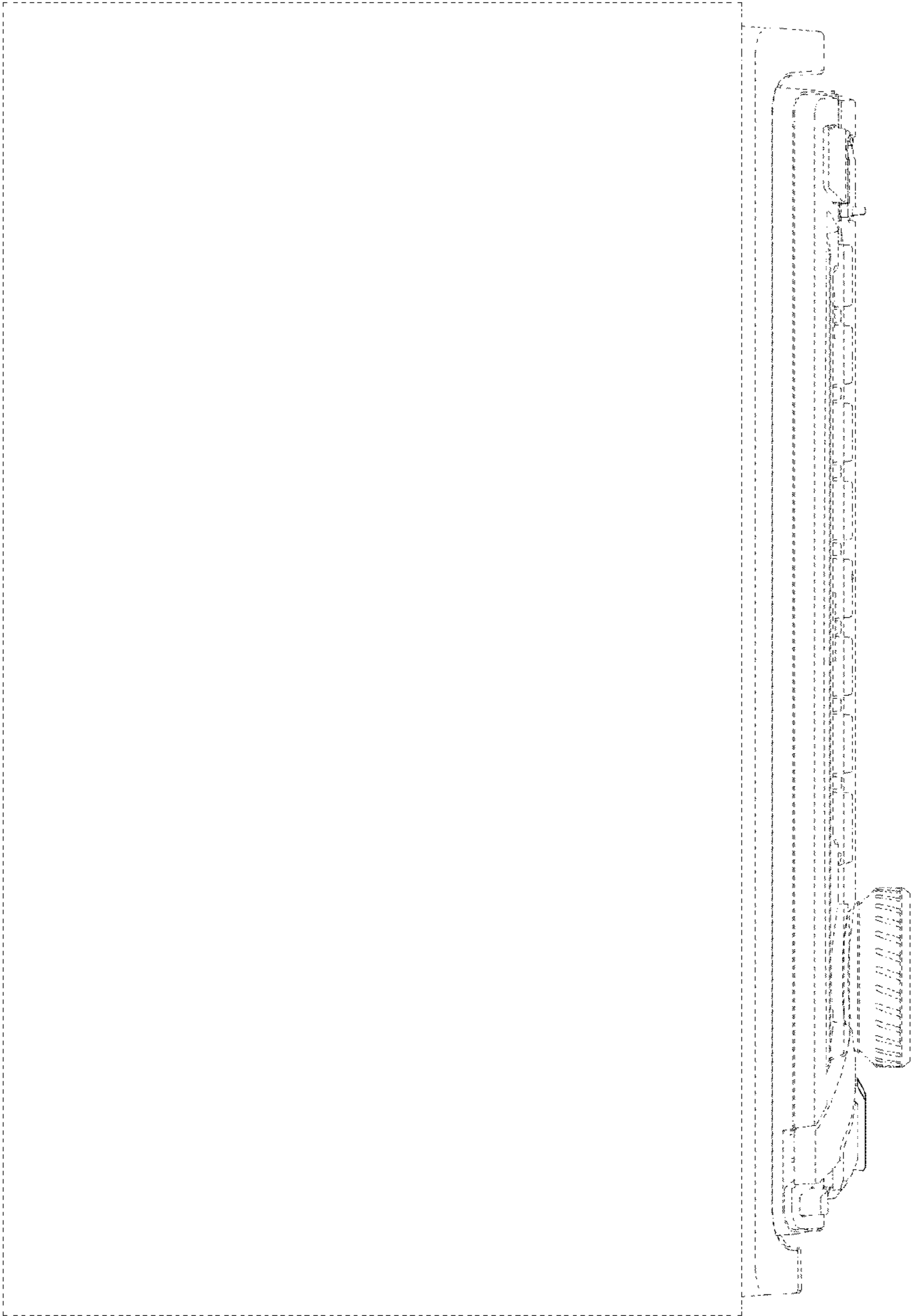

FIG.6

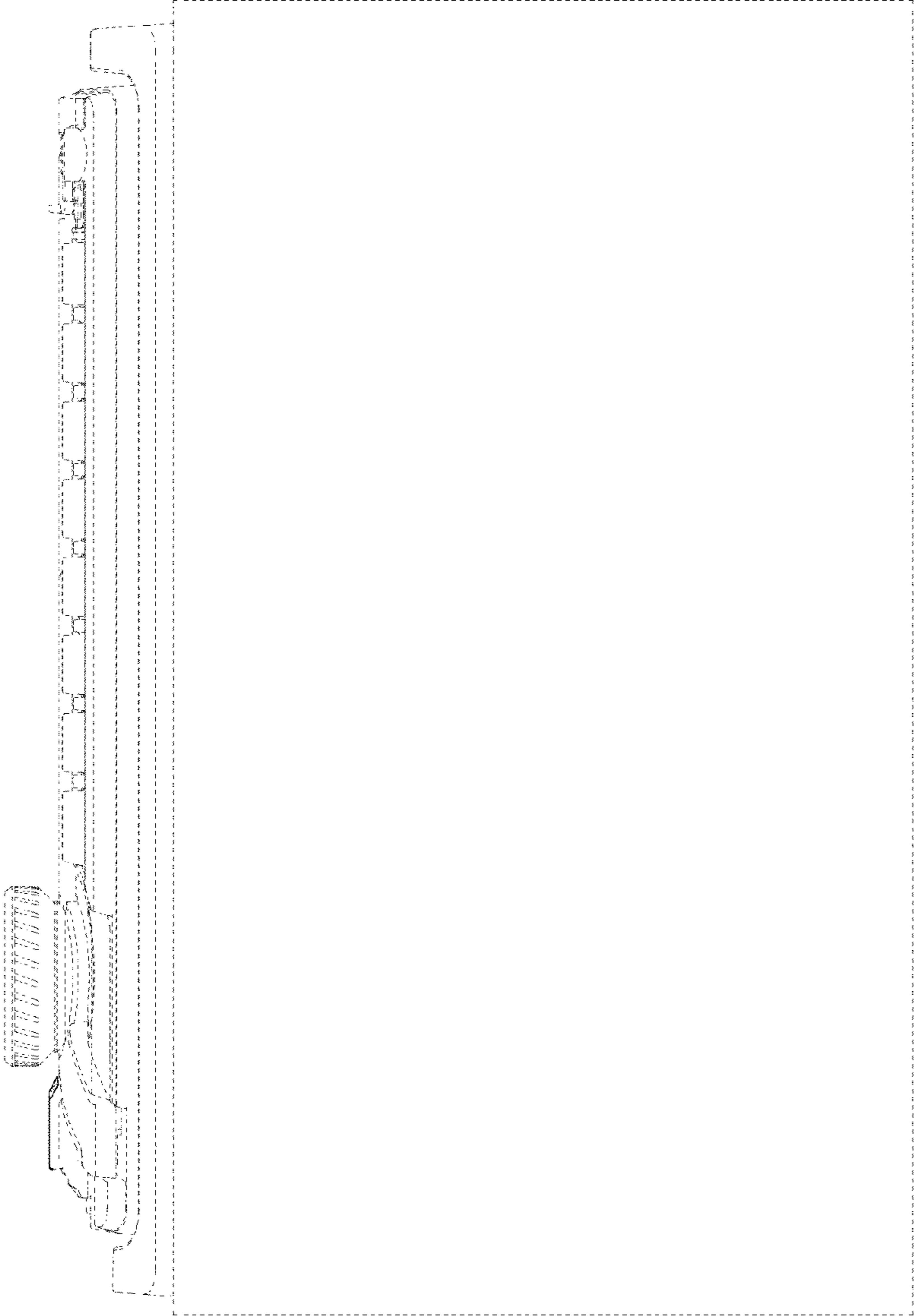

FIG.7

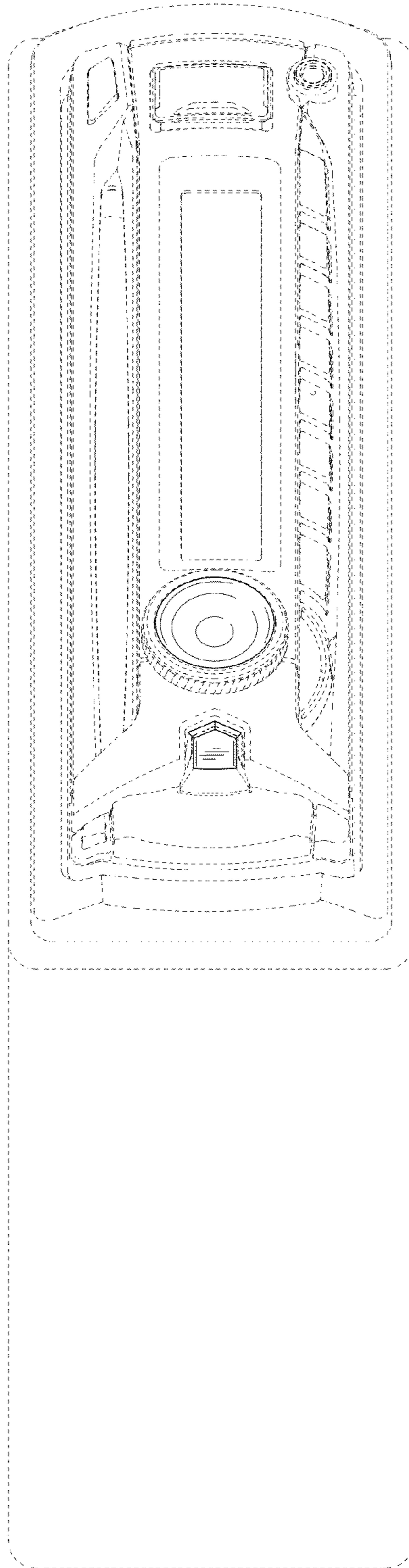

FIG.8

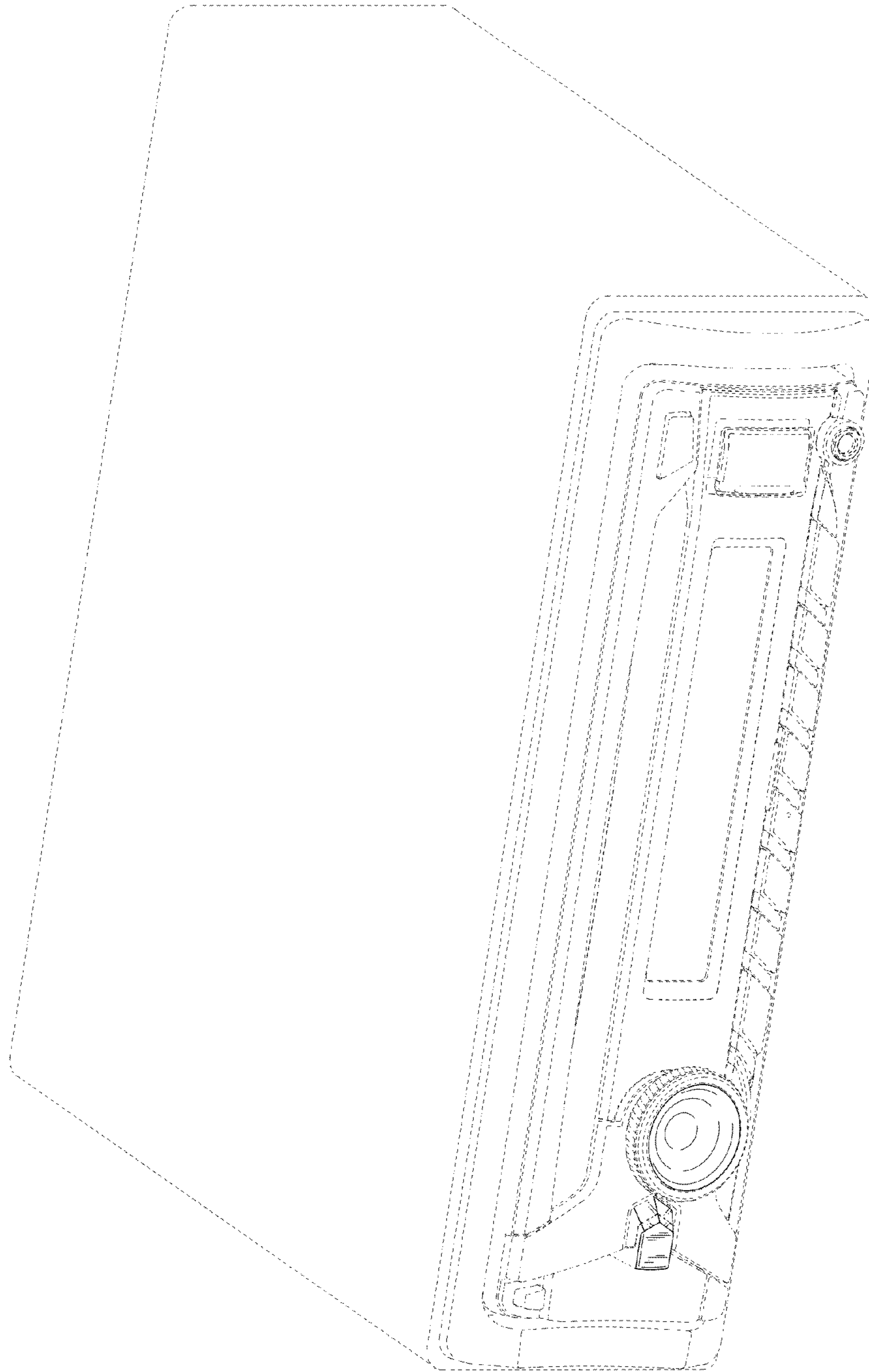

FIG.9



FIG.10

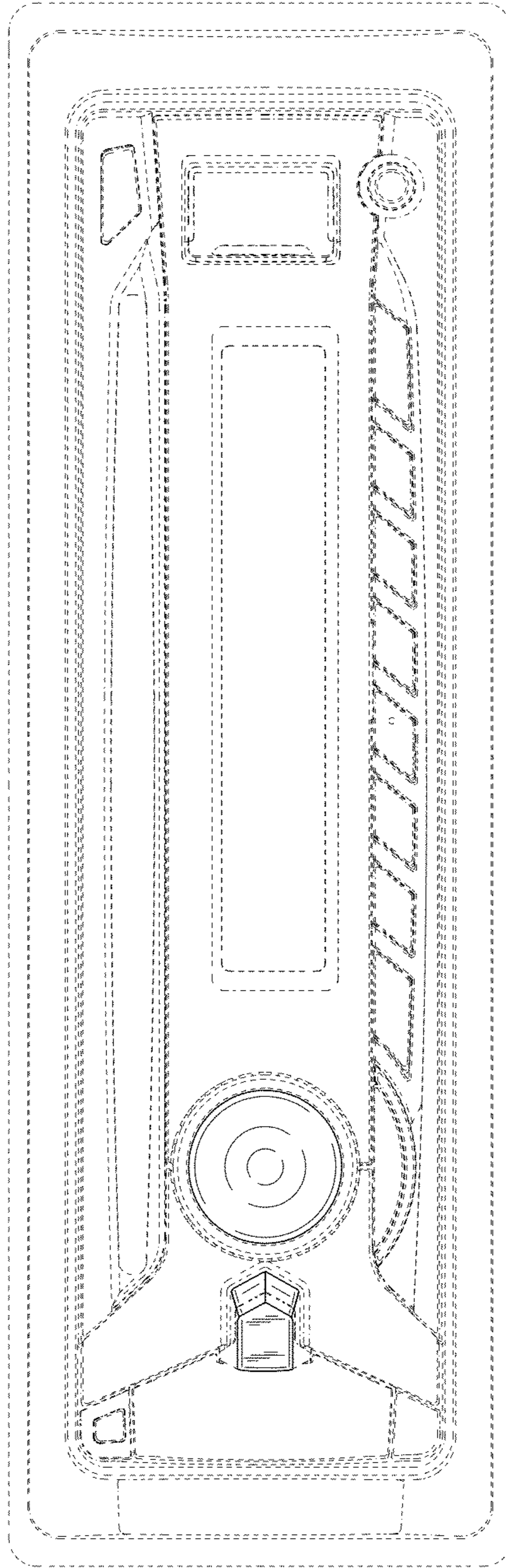

FIG.11

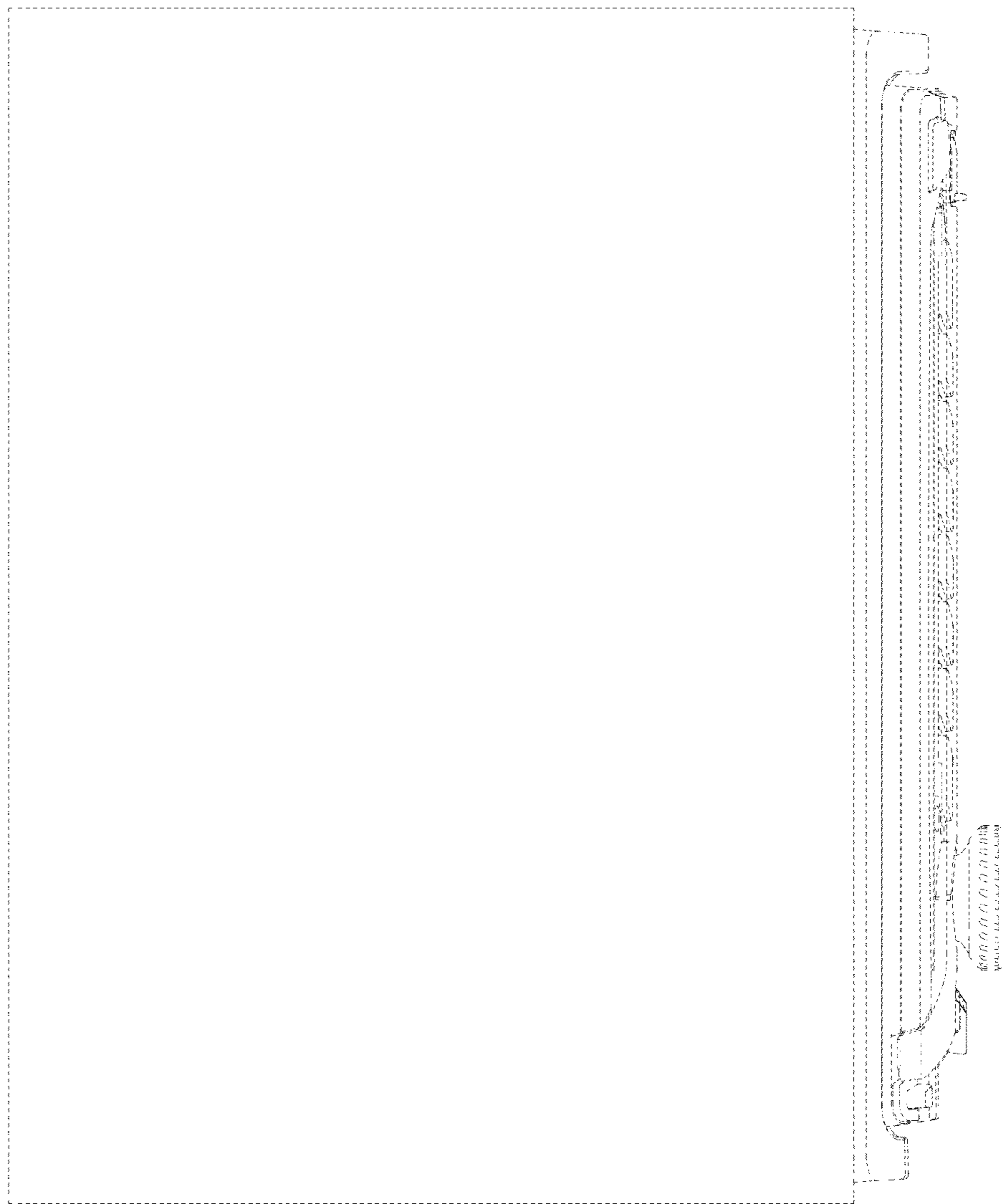

FIG.12

