



US00D724396S

(12) **United States Design Patent**
Van Pelt

(10) **Patent No.:** **US D724,396 S**
(45) **Date of Patent:** **** *Mar. 17, 2015**

- (54) **GARDEN PLANTER BOX**
- (76) Inventor: **Donald Wayne Van Pelt**, Clearlake Oaks, CA (US)
- (*) Notice: This patent is subject to a terminal disclaimer.
- (**) Term: **14 Years**
- (21) Appl. No.: **29/423,991**
- (22) Filed: **Jun. 6, 2012**
- (51) **LOC (10) Cl.** **11-02**
- (52) **U.S. Cl.**
USPC **D8/1**
- (58) **Field of Classification Search**
USPC D6/403–405, 556–558; D8/1; D11/143–156, 164; D19/77, 80, 81, D19/84; D25/100; D26/9–11, 16, 19; D34/1, 2, 4–6; D99/5, 19; 47/17, 32.4, 47/32.5, 33, 39, 41.01, 41.1, 41.11–41.15, 47/44–47, 65, 65.5, 65.9, 66.1, 66.6, 66.7, 47/67–71

See application file for complete search history.

(56) **References Cited**

U.S. PATENT DOCUMENTS

- 3,041,782 A * 7/1962 Bachman 47/39
- 4,658,541 A * 4/1987 Haile D11/143

(Continued)

Primary Examiner — Garth Rademaker

(74) *Attorney, Agent, or Firm* — Kevin Matthew Welch

(57) **CLAIM**

The ornamental design for a garden planter box, as shown and described.

DESCRIPTION

FIG. 1 is a perspective view of a first embodiment of a garden planter box;
 FIG. 2 is a front elevation view thereof;
 FIG. 3 is a rear elevation view thereof;
 FIG. 4 is a right side elevation view thereof;
 FIG. 5 is a left side elevation view thereof;
 FIG. 6 is a top plan view thereof;
 FIG. 7 is a bottom plan view thereof;
 FIG. 8 is a perspective view of one of the corner block components of the first embodiment of the garden planter box, shown separately for ease of disclosure;

FIG. 9 is a front elevation view thereof;
 FIG. 10 is a back elevation view thereof;
 FIG. 11 is a right side elevation view thereof;
 FIG. 12 is a left side elevation view thereof;
 FIG. 13 is a top plan view thereof;
 FIG. 14 is a bottom plan view thereof;
 FIG. 15 is a perspective view of one of the straight block components of the first embodiment of the garden planter box, shown separately for ease of disclosure;
 FIG. 16 is a front elevation view thereof;
 FIG. 17 is a back elevation view thereof;
 FIG. 18 is a right side elevation view thereof;
 FIG. 19 is a left side elevation view thereof;
 FIG. 20 is a top plan view thereof;
 FIG. 21 is a bottom plan view thereof;
 FIG. 22 is a perspective view of a second embodiment of a garden planter box;
 FIG. 23 is a front elevation view thereof;
 FIG. 24 is a rear elevation view thereof;
 FIG. 25 is a right side elevation view thereof;
 FIG. 26 is a left side elevation view thereof;
 FIG. 27 is a top plan view thereof;
 FIG. 28 is a bottom plan view thereof;
 FIG. 29 is a perspective view of one of the corner block components of the second embodiment of the garden planter box, shown separately for ease of disclosure;
 FIG. 30 is a front elevation view thereof;
 FIG. 31 is a back elevation view thereof;
 FIG. 32 is a right side elevation view thereof;
 FIG. 33 is a left side elevation view thereof;
 FIG. 34 is a top plan view thereof;
 FIG. 35 is a bottom plan view thereof;
 FIG. 36 is a perspective view of one of the straight block components of the second embodiment of the garden planter box, shown separately for ease of disclosure;
 FIG. 37 is a front elevation view thereof;
 FIG. 38 is a back elevation view thereof;
 FIG. 39 is a right side elevation view thereof;
 FIG. 40 is a left side elevation view thereof;
 FIG. 41 is a top plan view thereof; and,
 FIG. 42 is a bottom plan view thereof.
 The broken lines in the figures indicate that the design is of no specific width or depth and form no part of the claimed design.

1 Claim, 24 Drawing Sheets

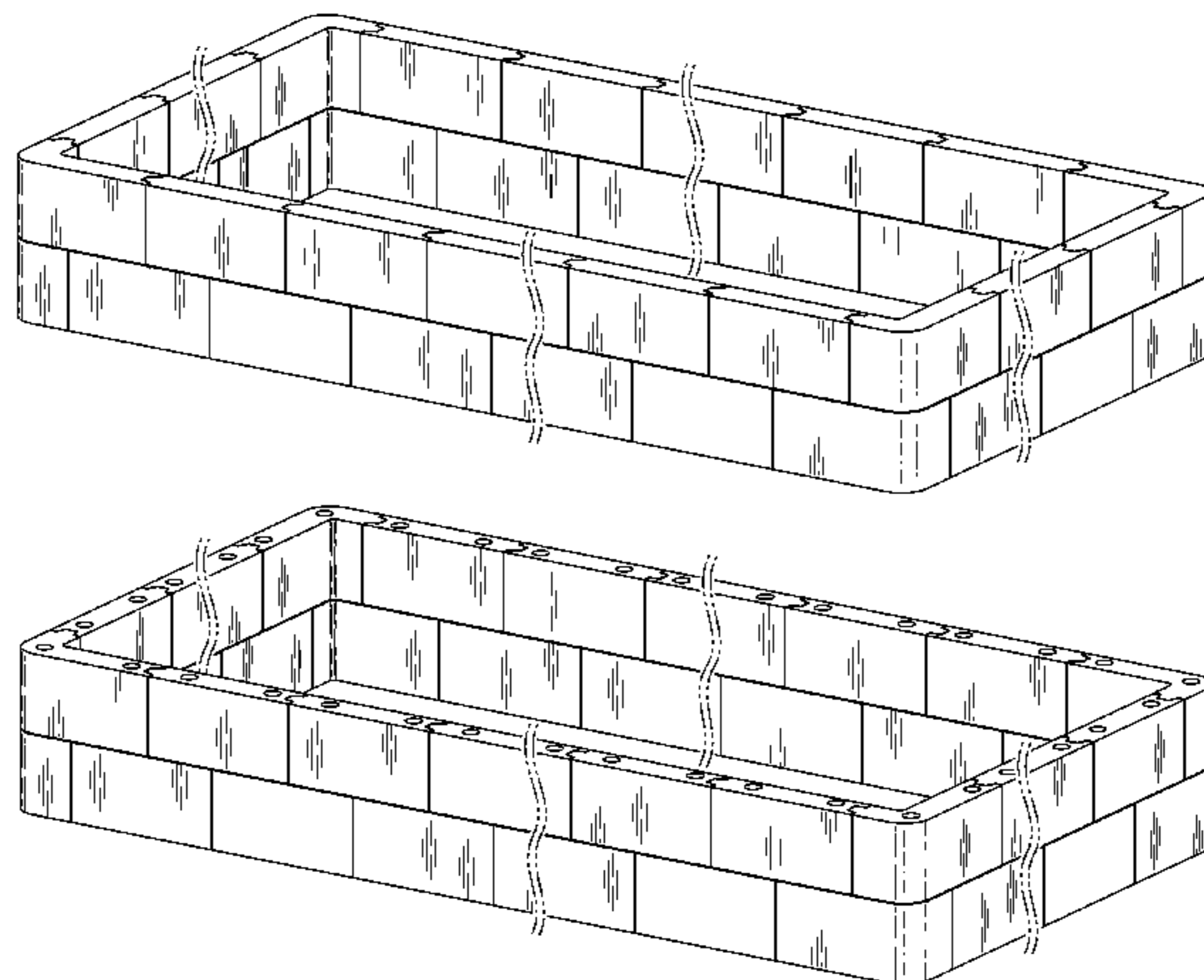

(56)

References Cited

U.S. PATENT DOCUMENTS

D304,318 S * 10/1989 Tervo et al. D11/155
D343,509 S * 1/1994 Scott et al. D8/1
D346,726 S * 5/1994 Scott et al. D8/1
D355,340 S * 2/1995 Scott et al. D8/1

D402,229 S * 12/1998 Christensen D11/155
D502,425 S * 3/2005 Barry D11/155
D536,584 S * 2/2007 Petty D8/1
D646,532 S * 10/2011 Burns D8/1
D647,767 S * 11/2011 Greenes et al. D8/1
D651,121 S * 12/2011 Grimme D11/155

* cited by examiner

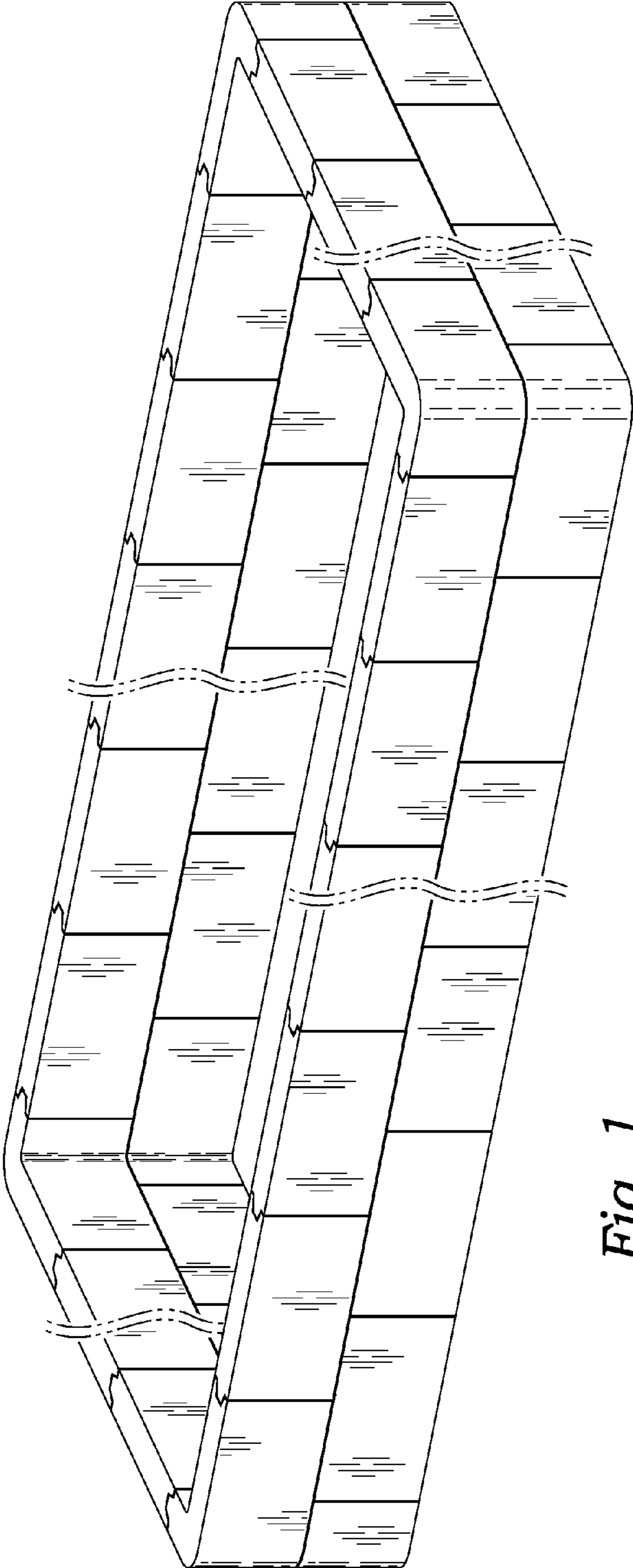

Fig. 1

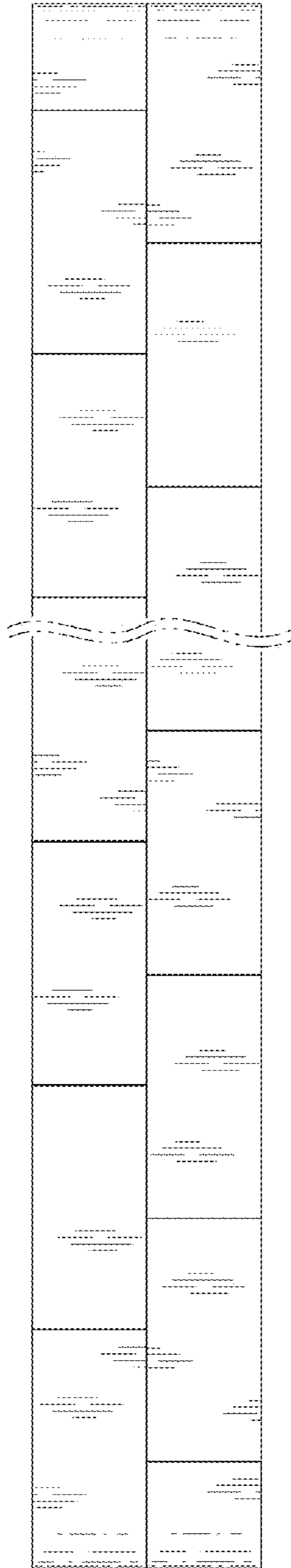

Fig. 2

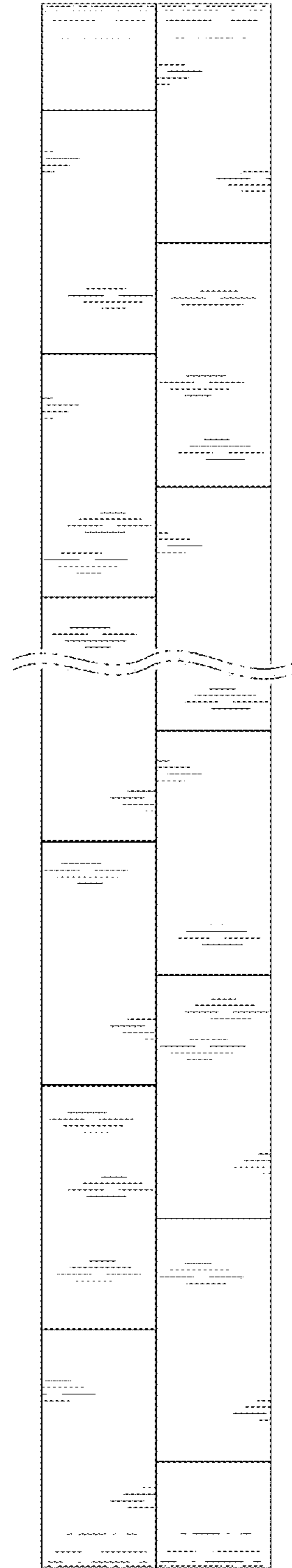

Fig. 3

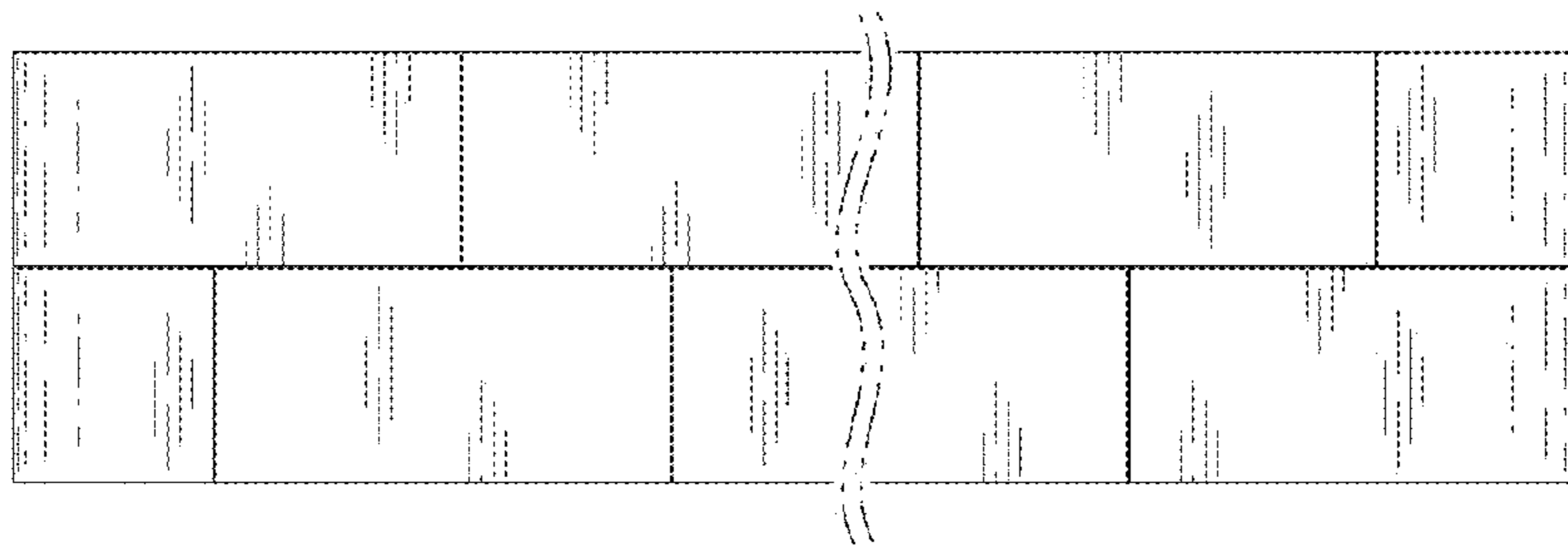

Fig. 4

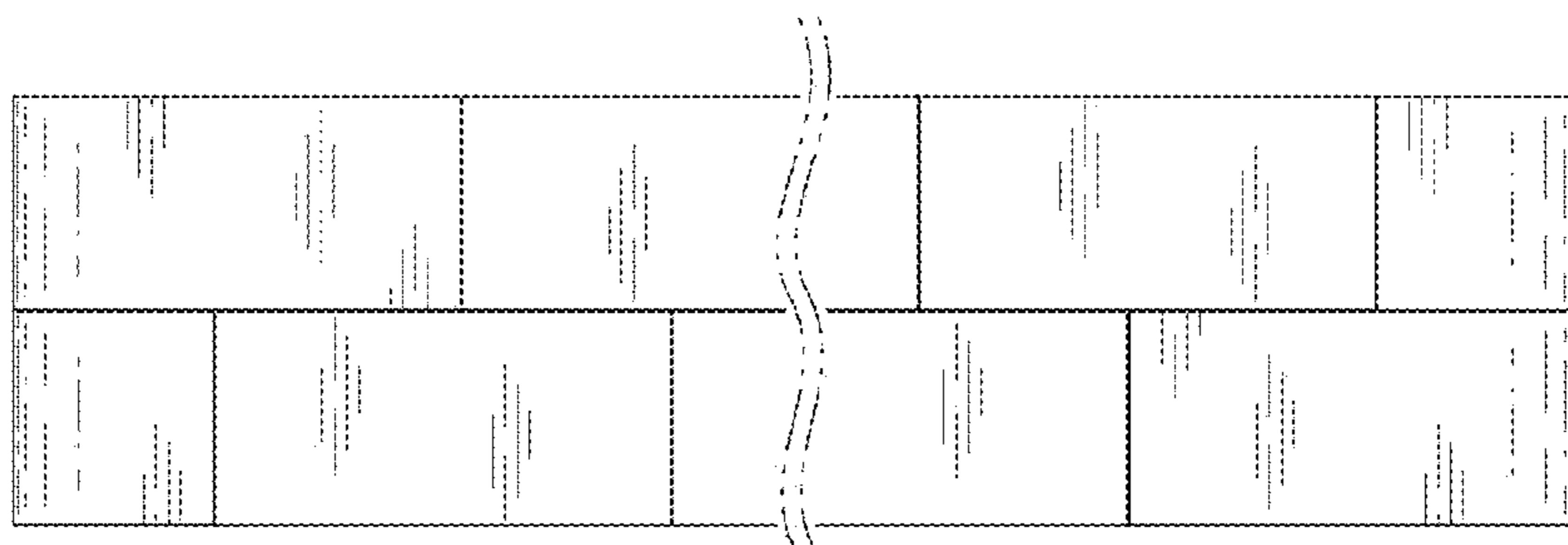

Fig. 5

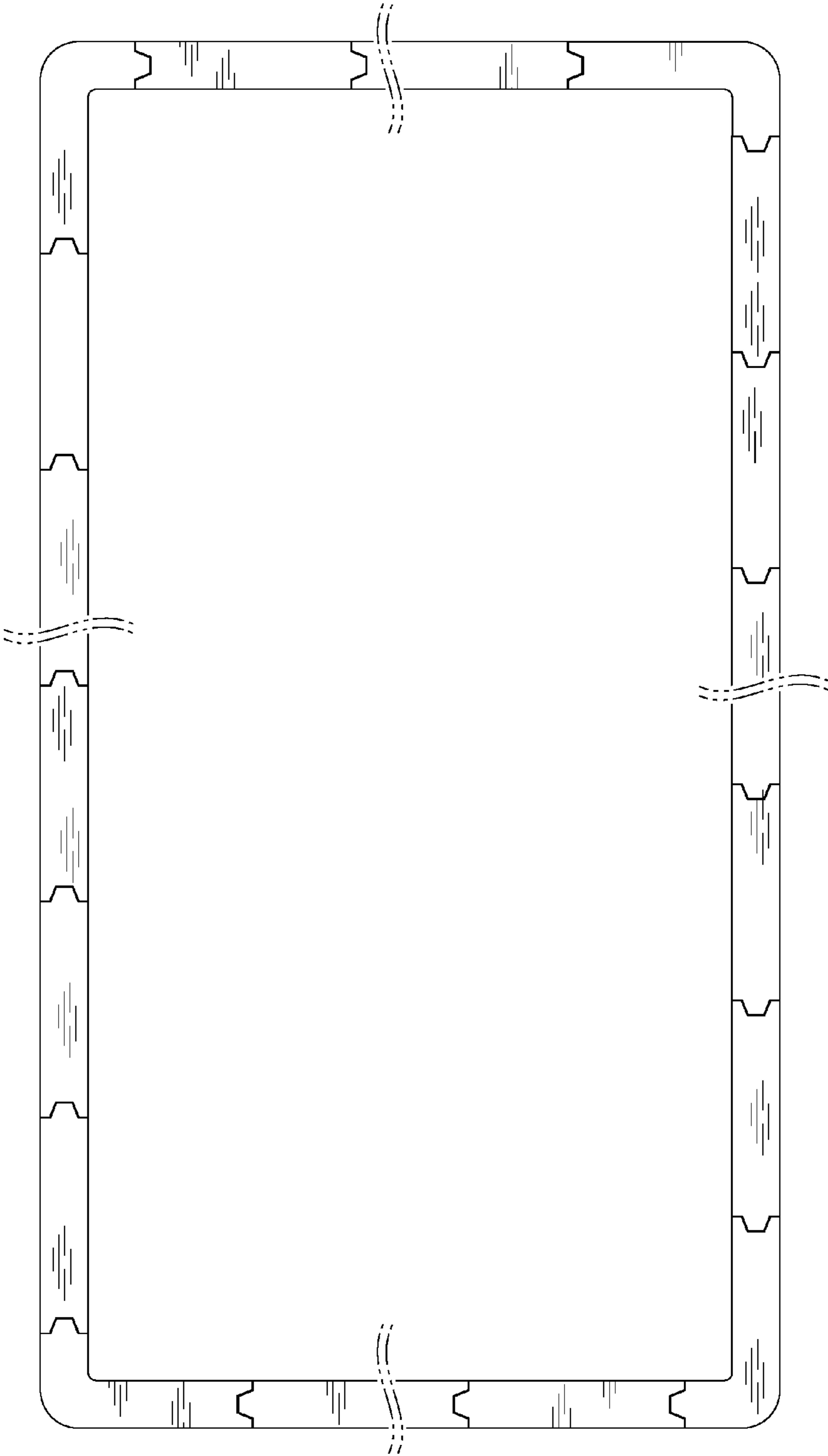

Fig. 6

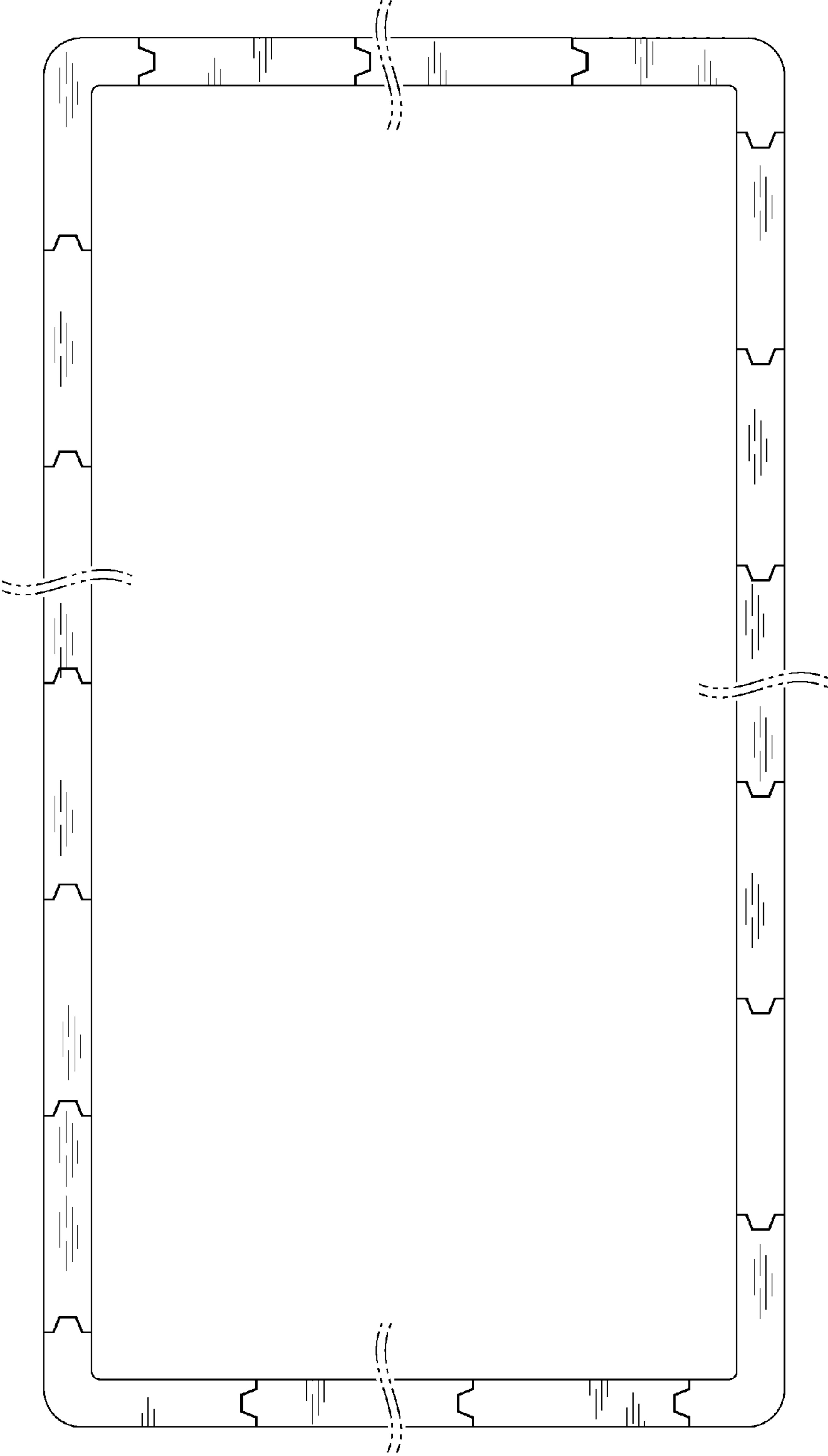

Fig. 7

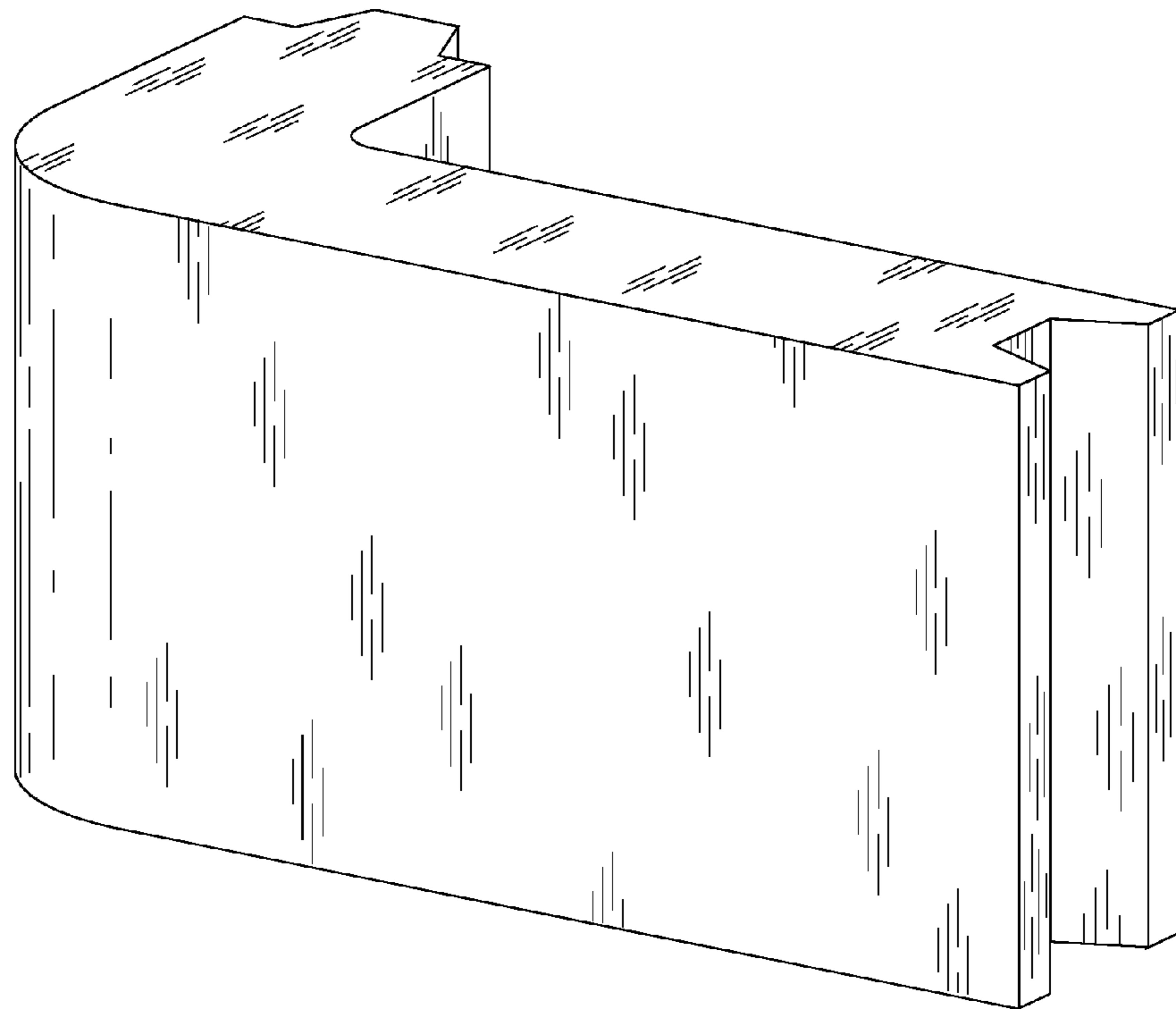

Fig. 8

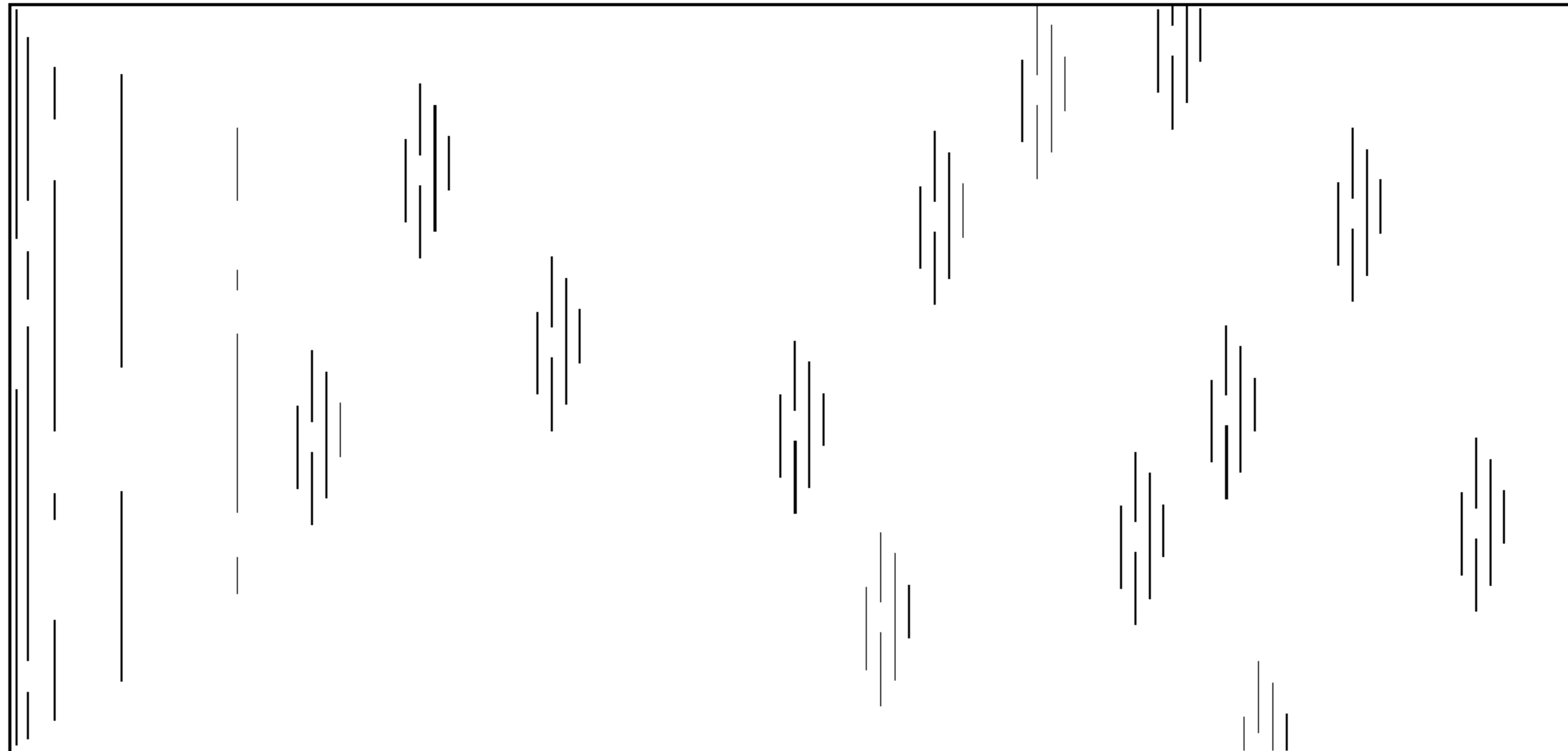

Fig. 9

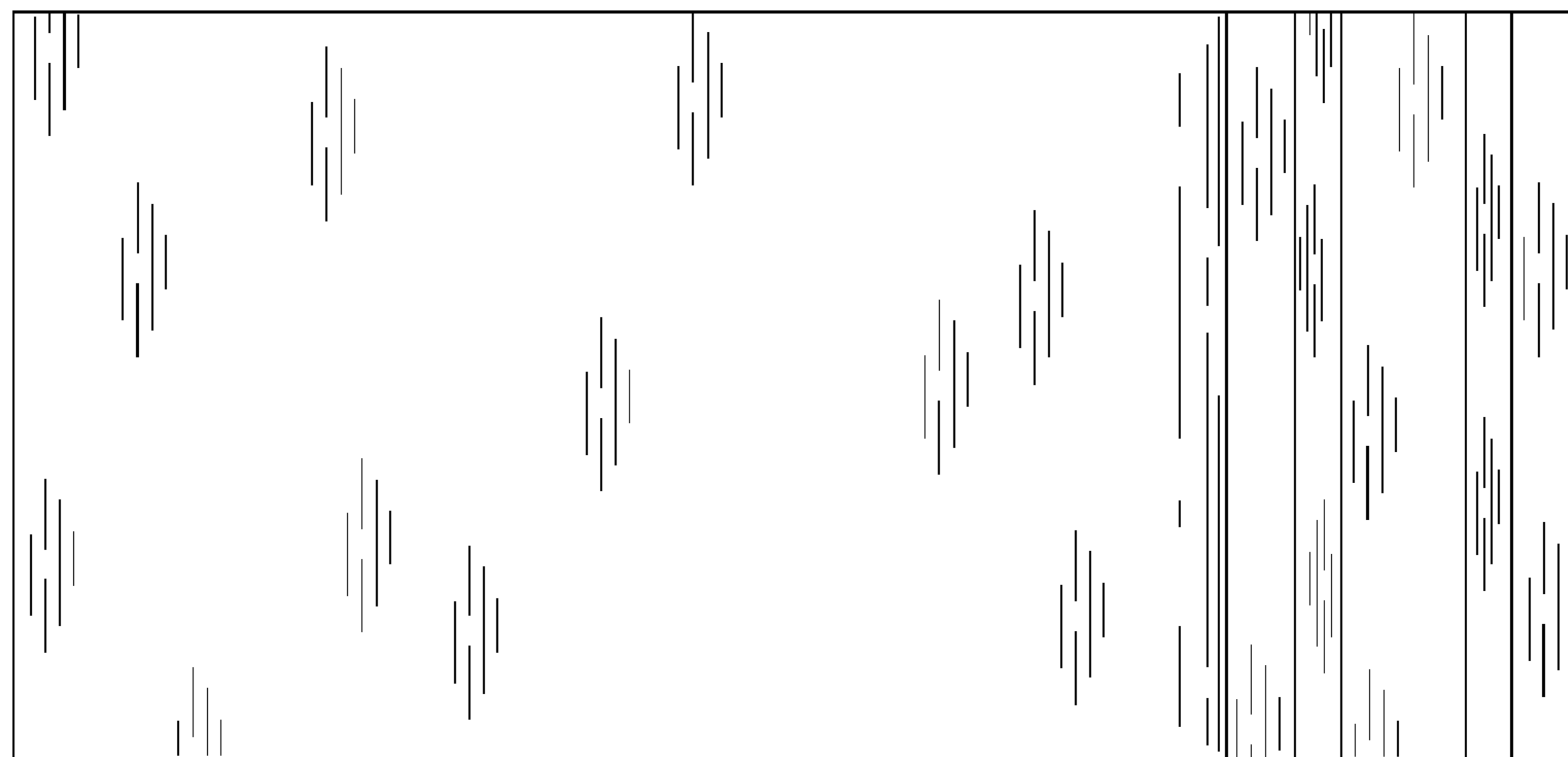

Fig. 10

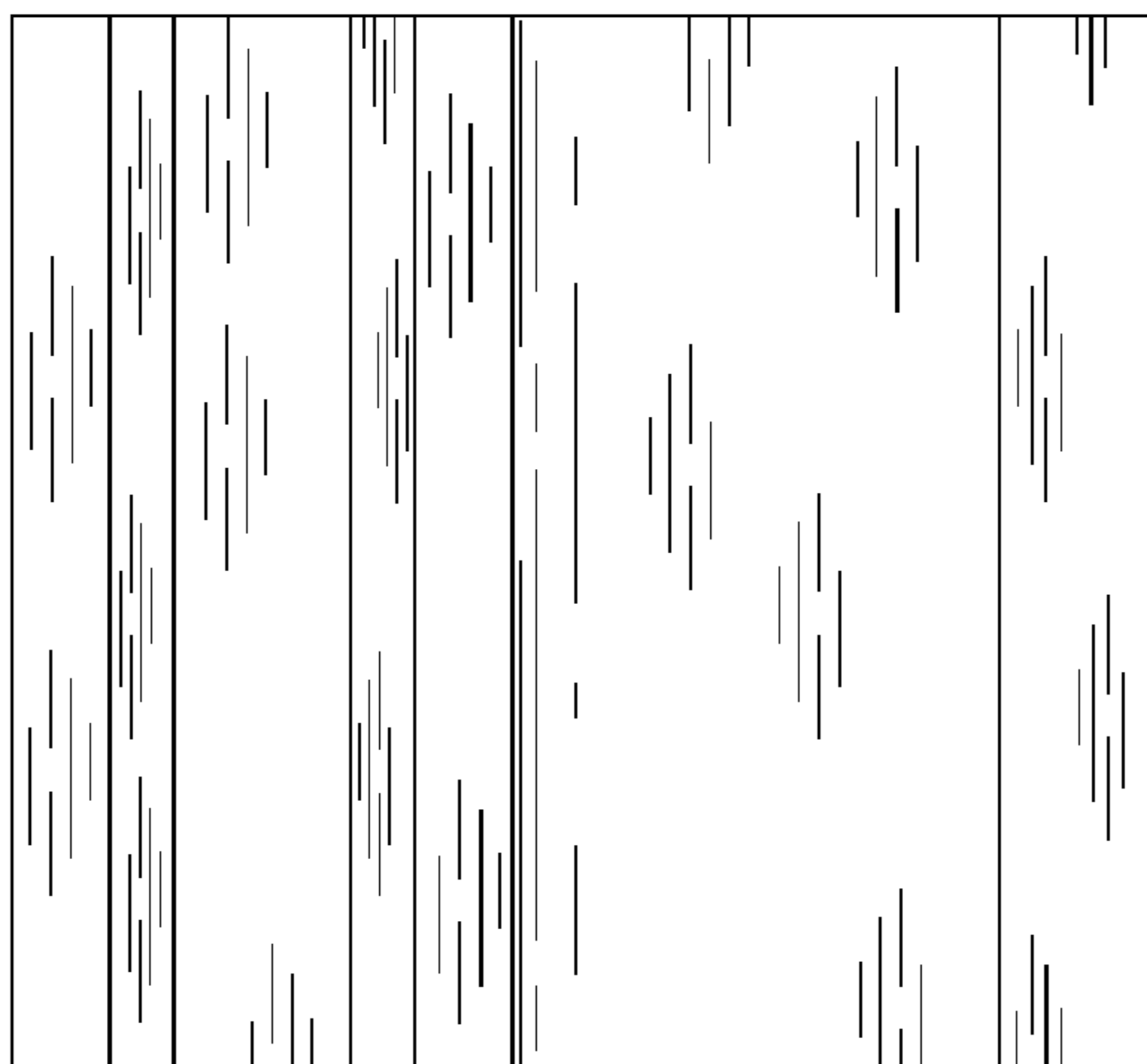

Fig. 11

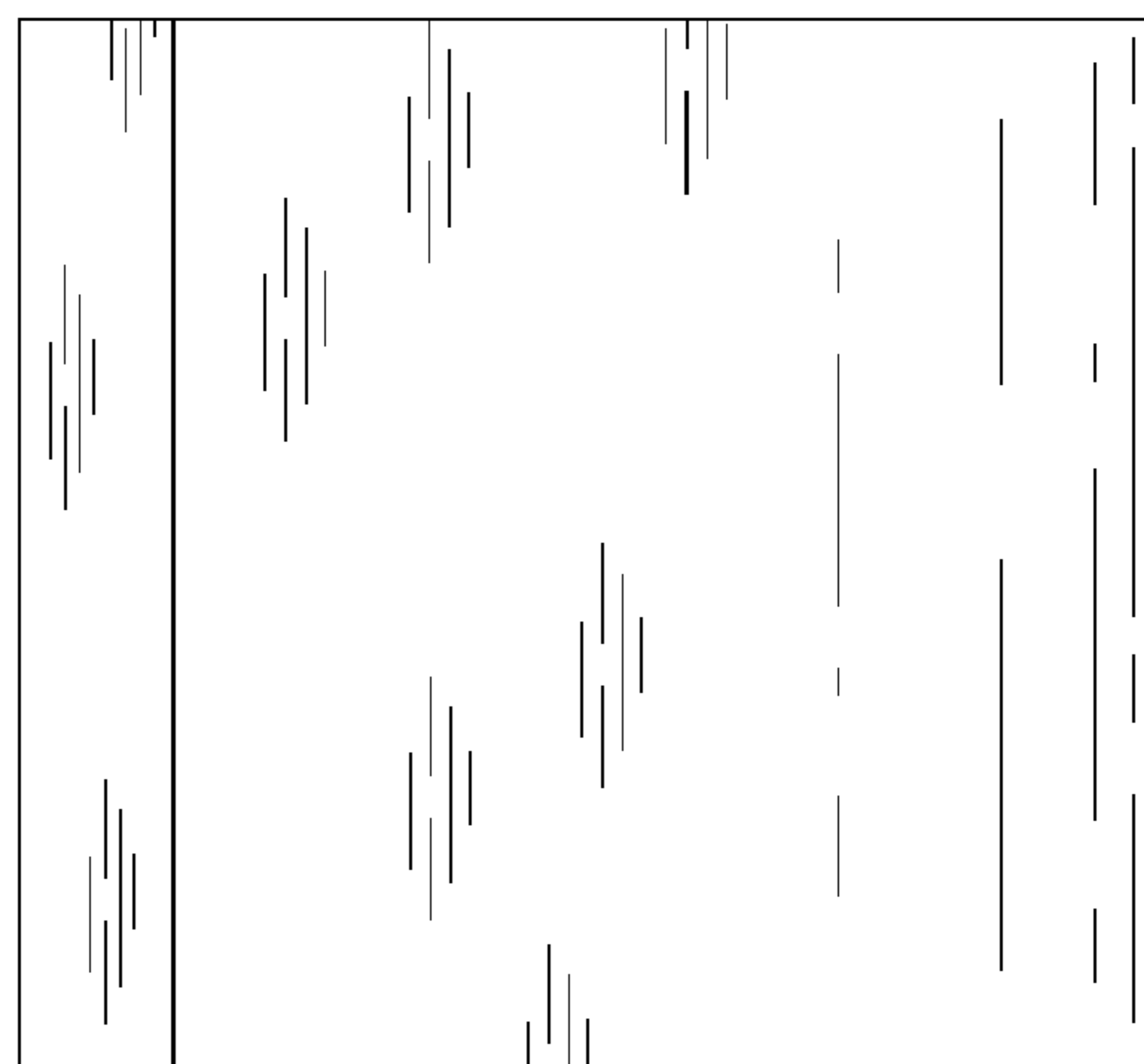

Fig. 12

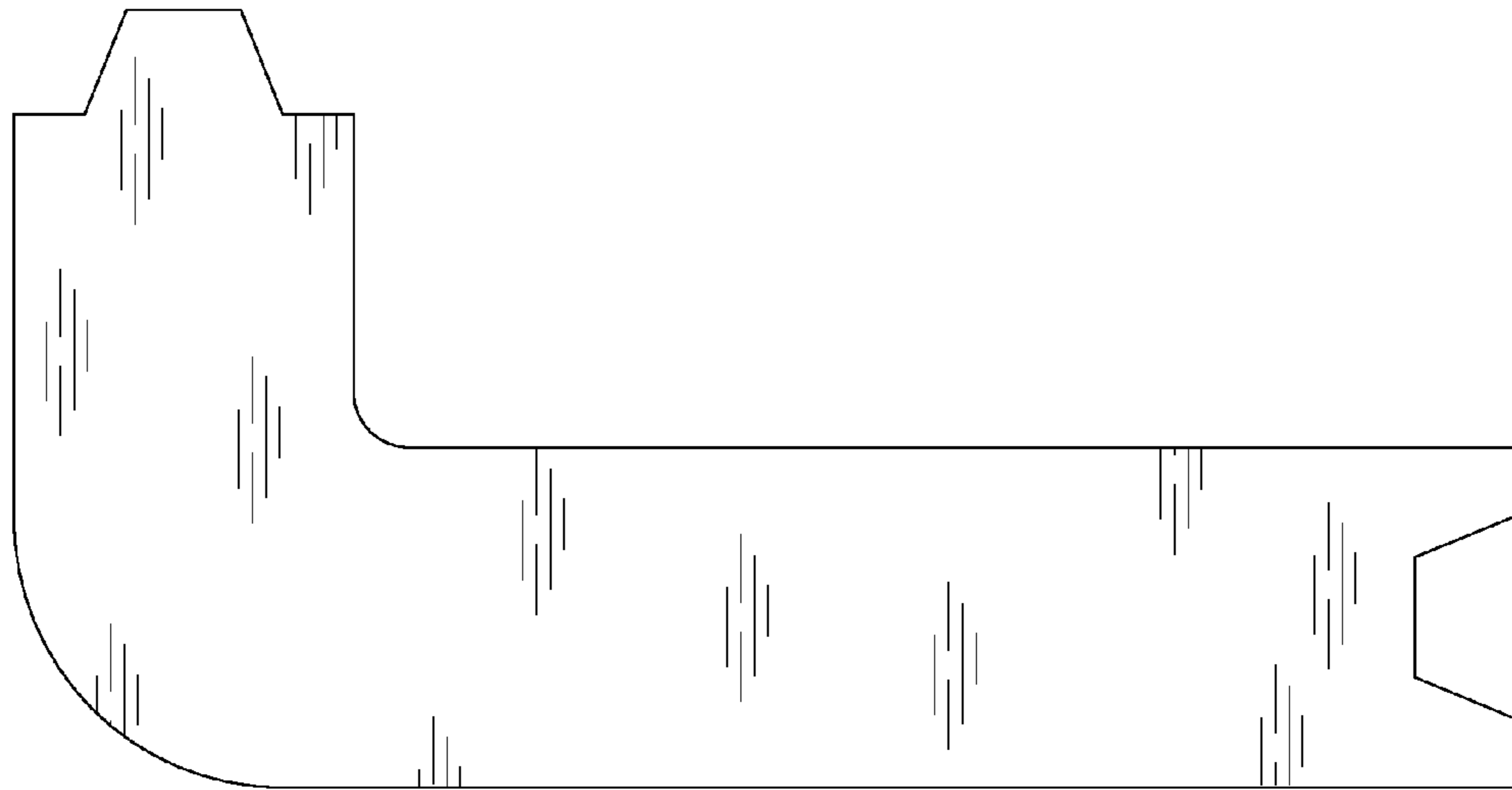

Fig. 13



Fig. 14

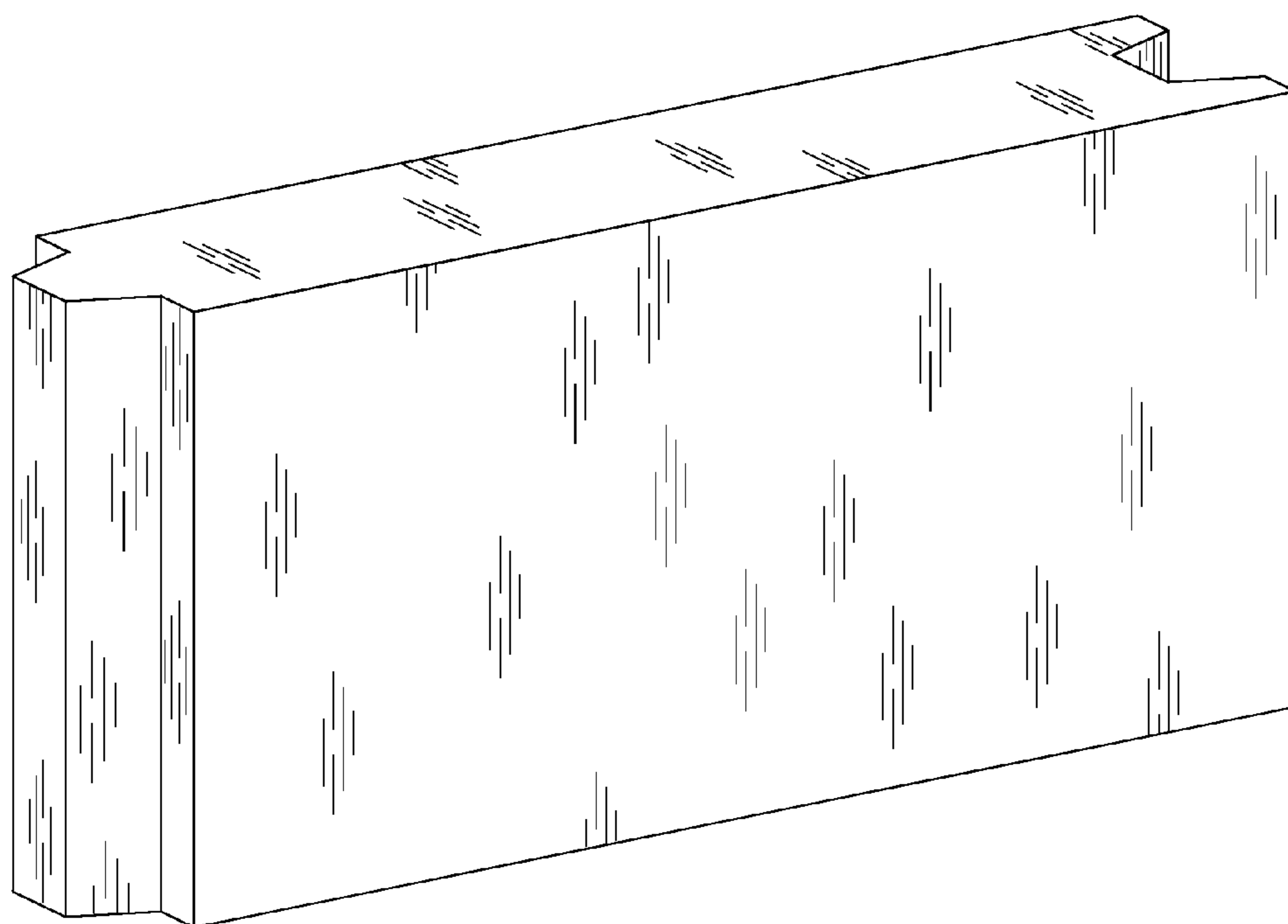

Fig. 15

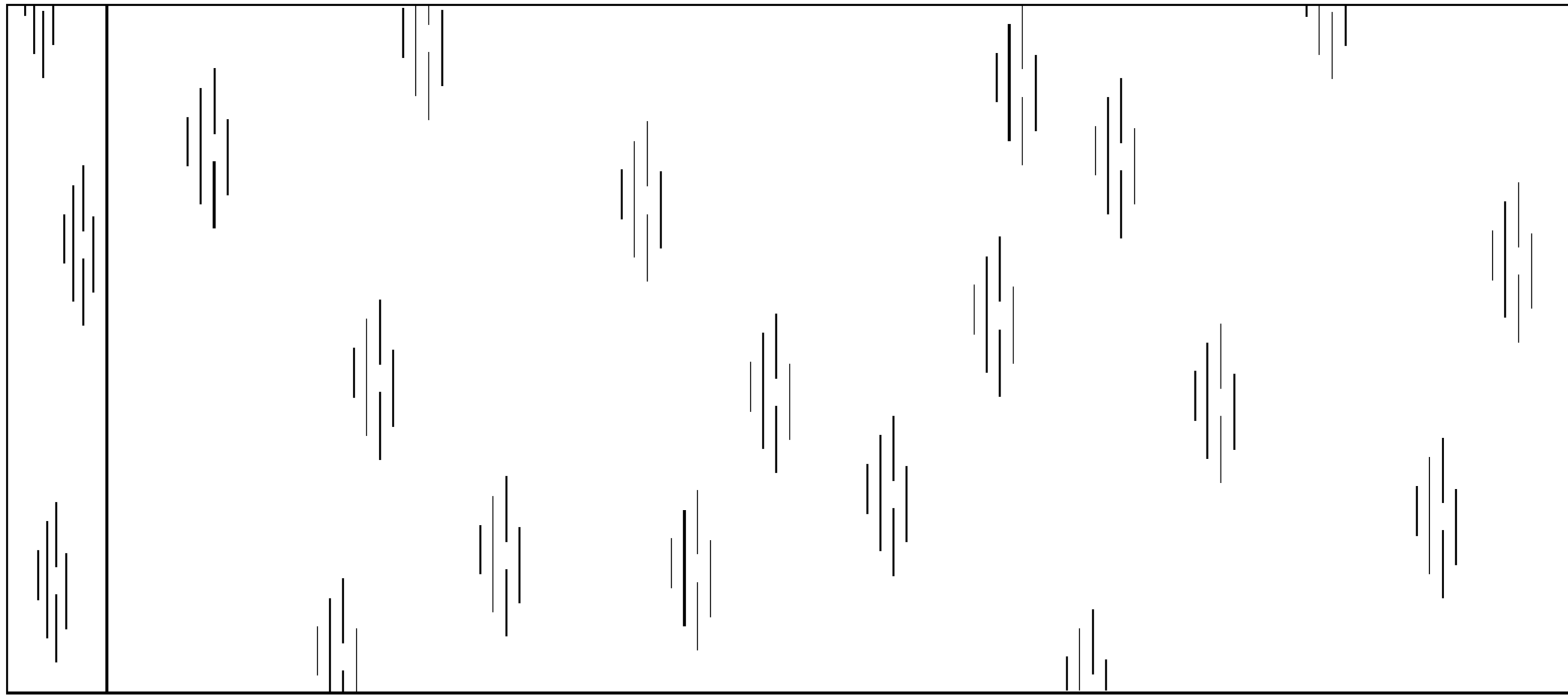

Fig. 16



Fig. 17

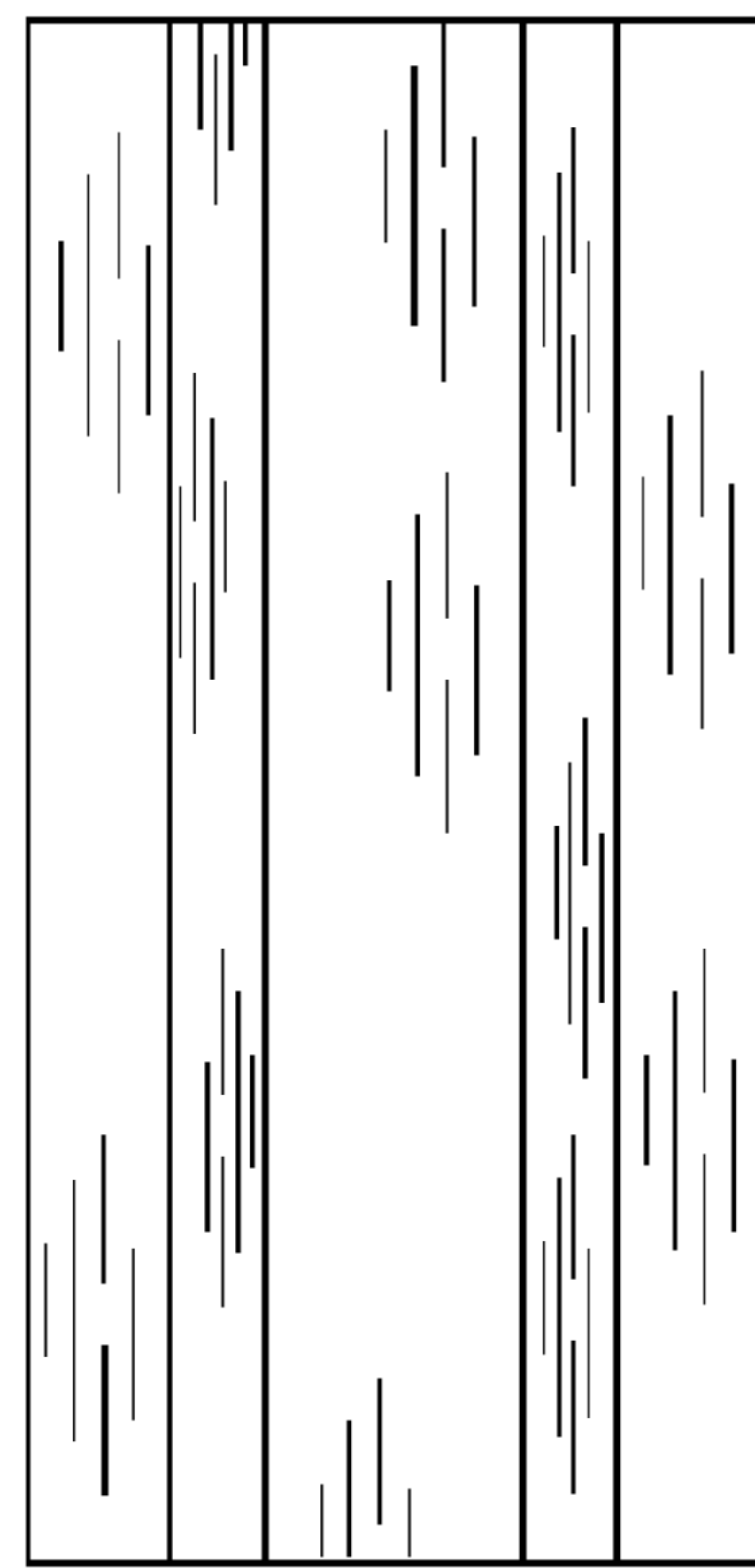

Fig. 18

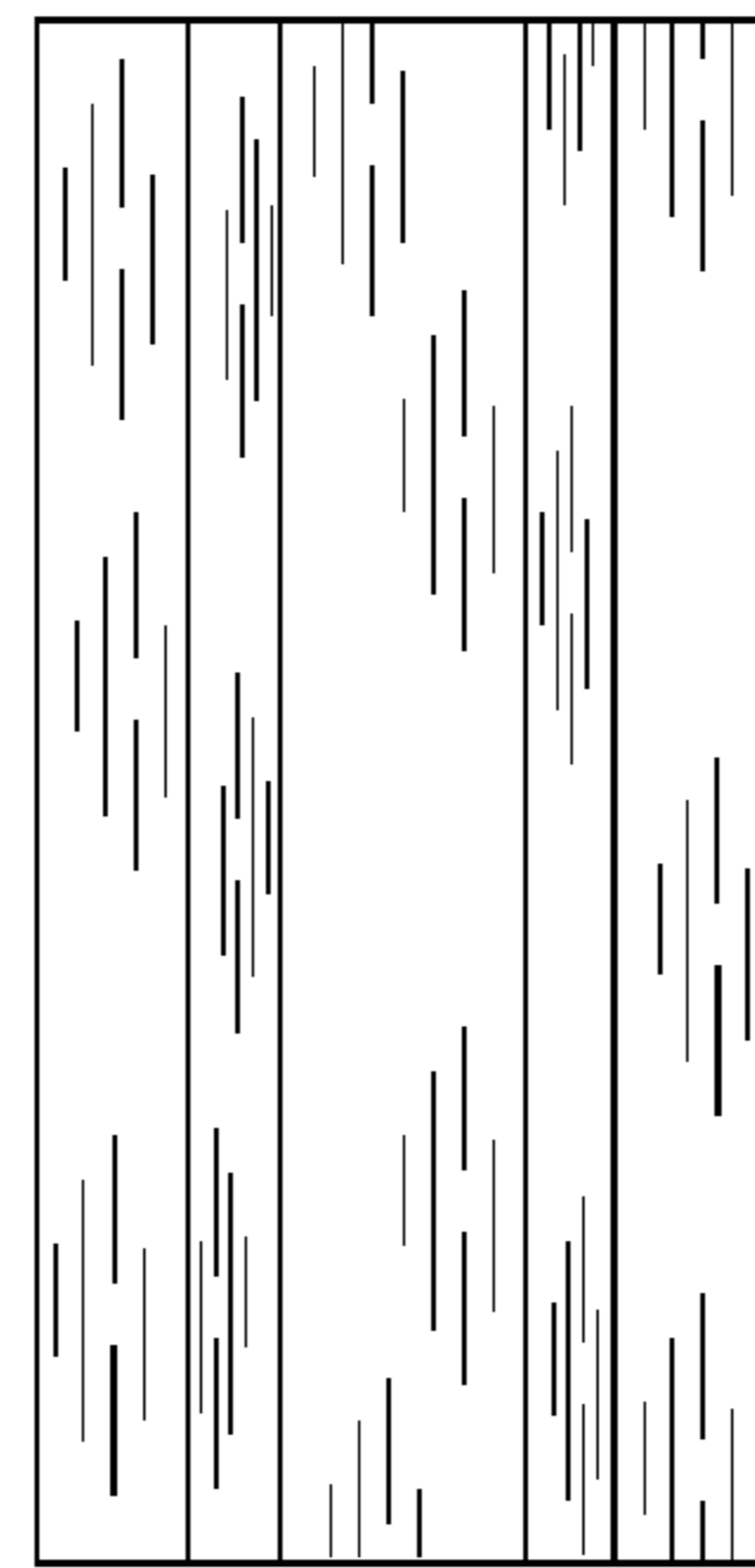

Fig. 19

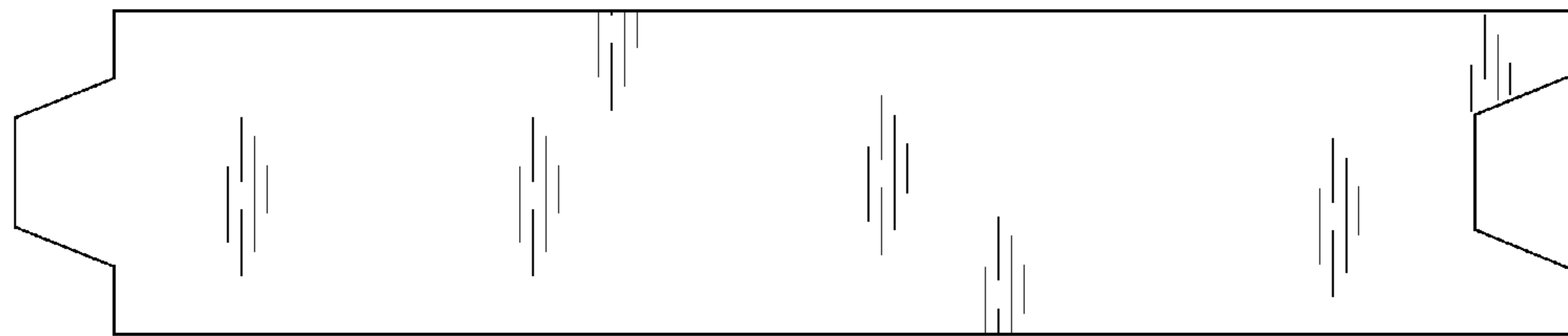

Fig. 20

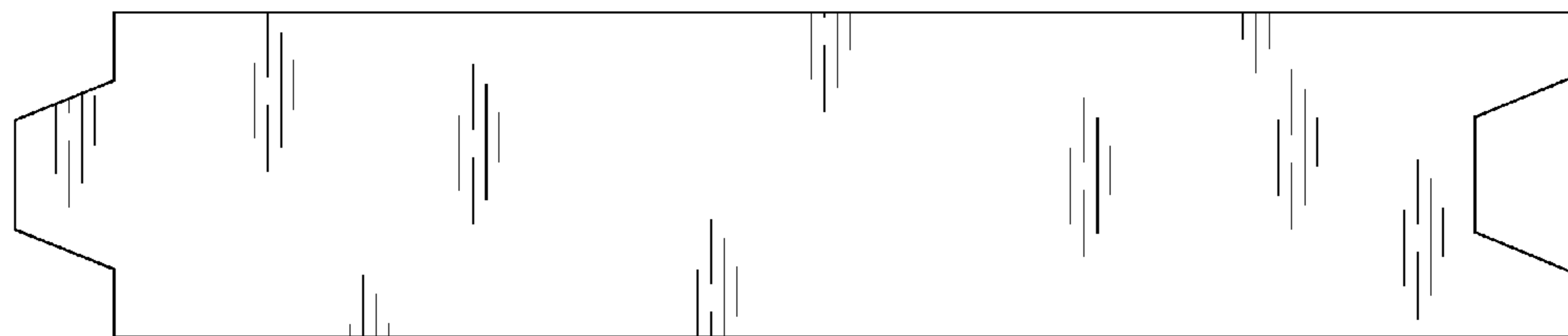

Fig. 21

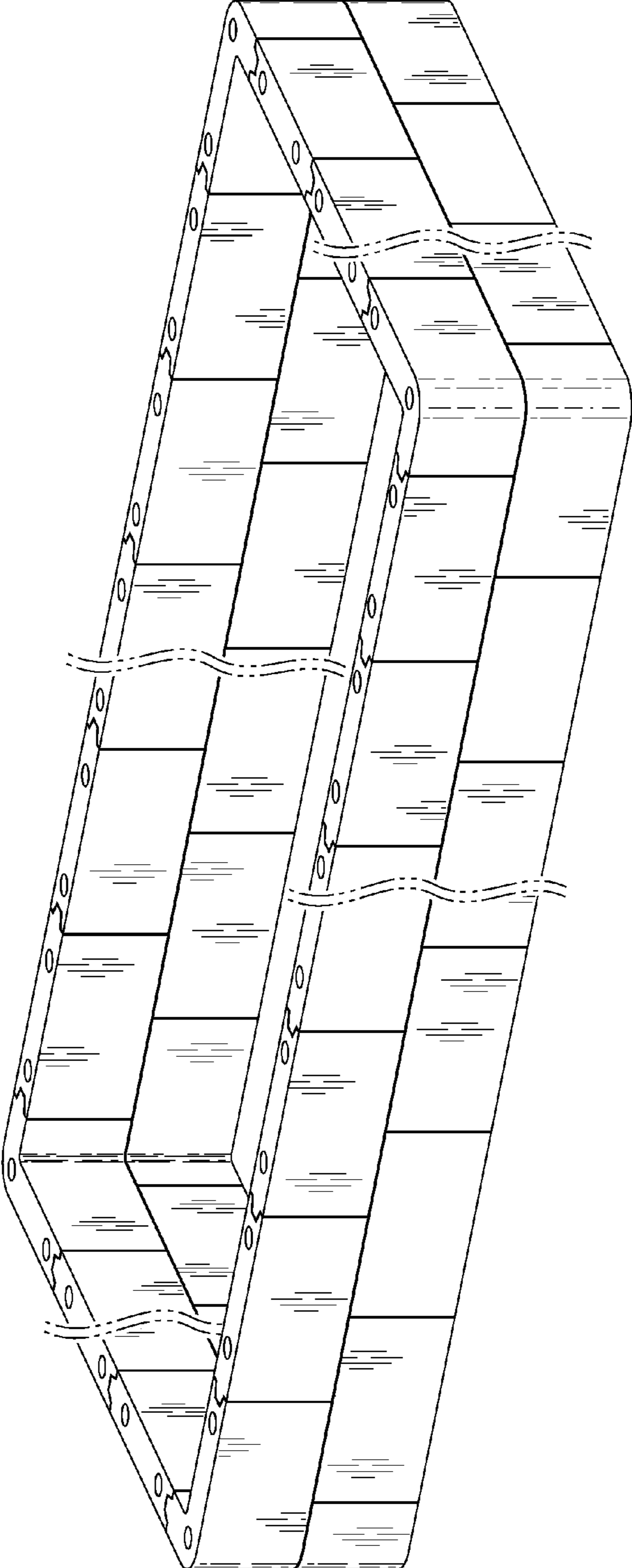

Fig. 22

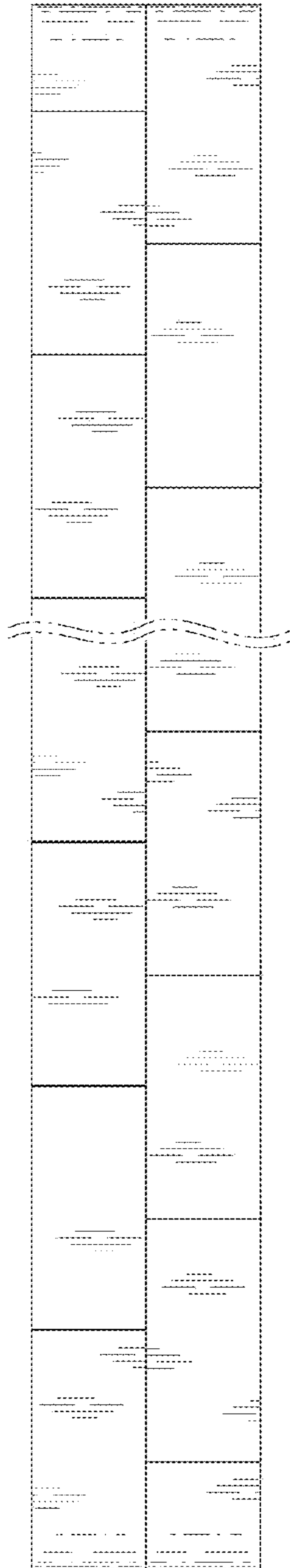

Fig. 23

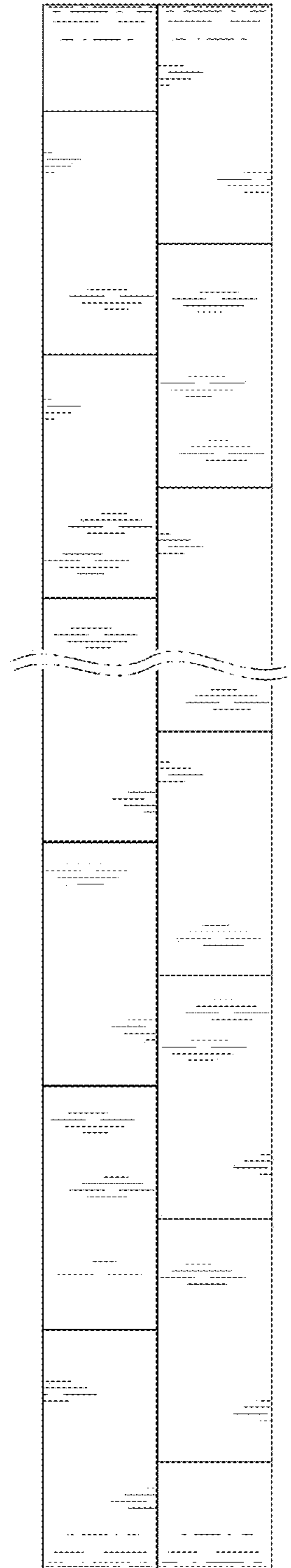

Fig. 24

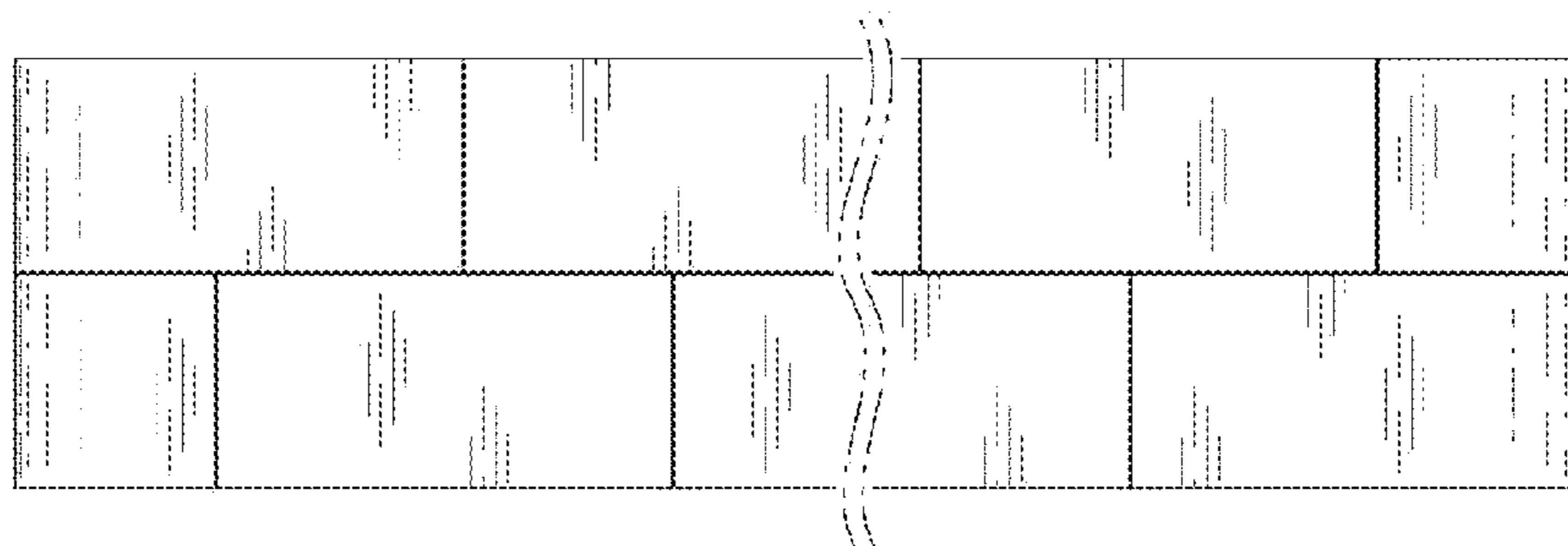

Fig. 25

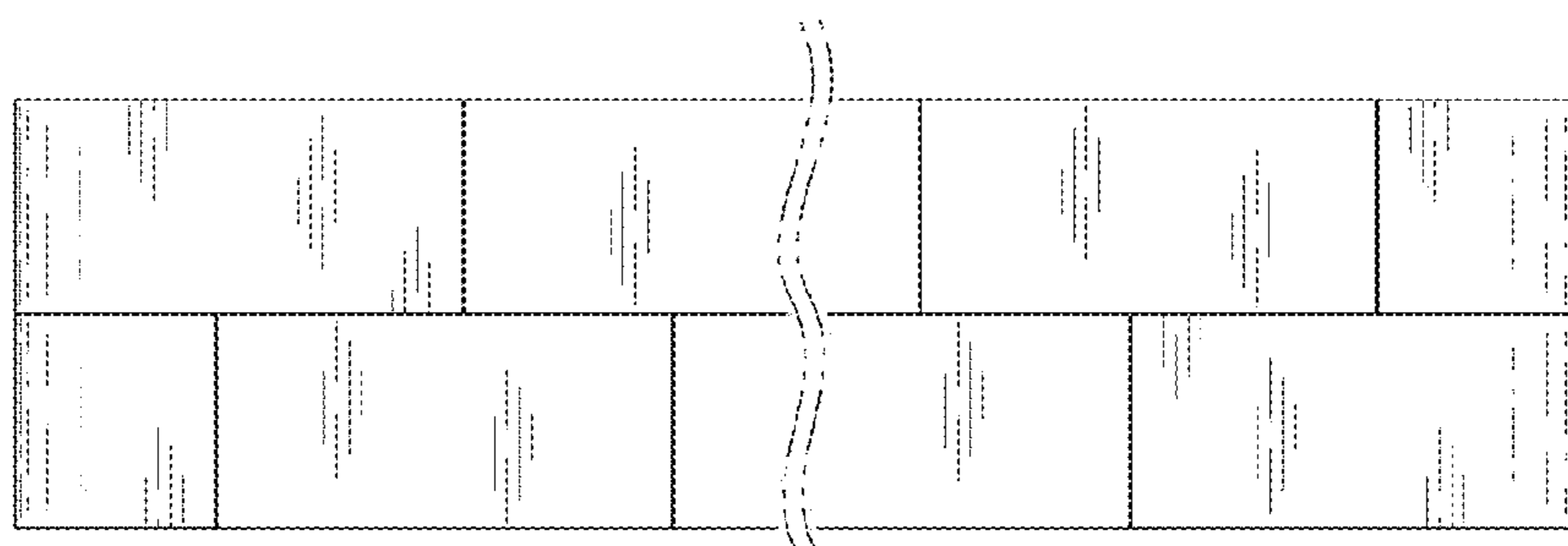

Fig. 26

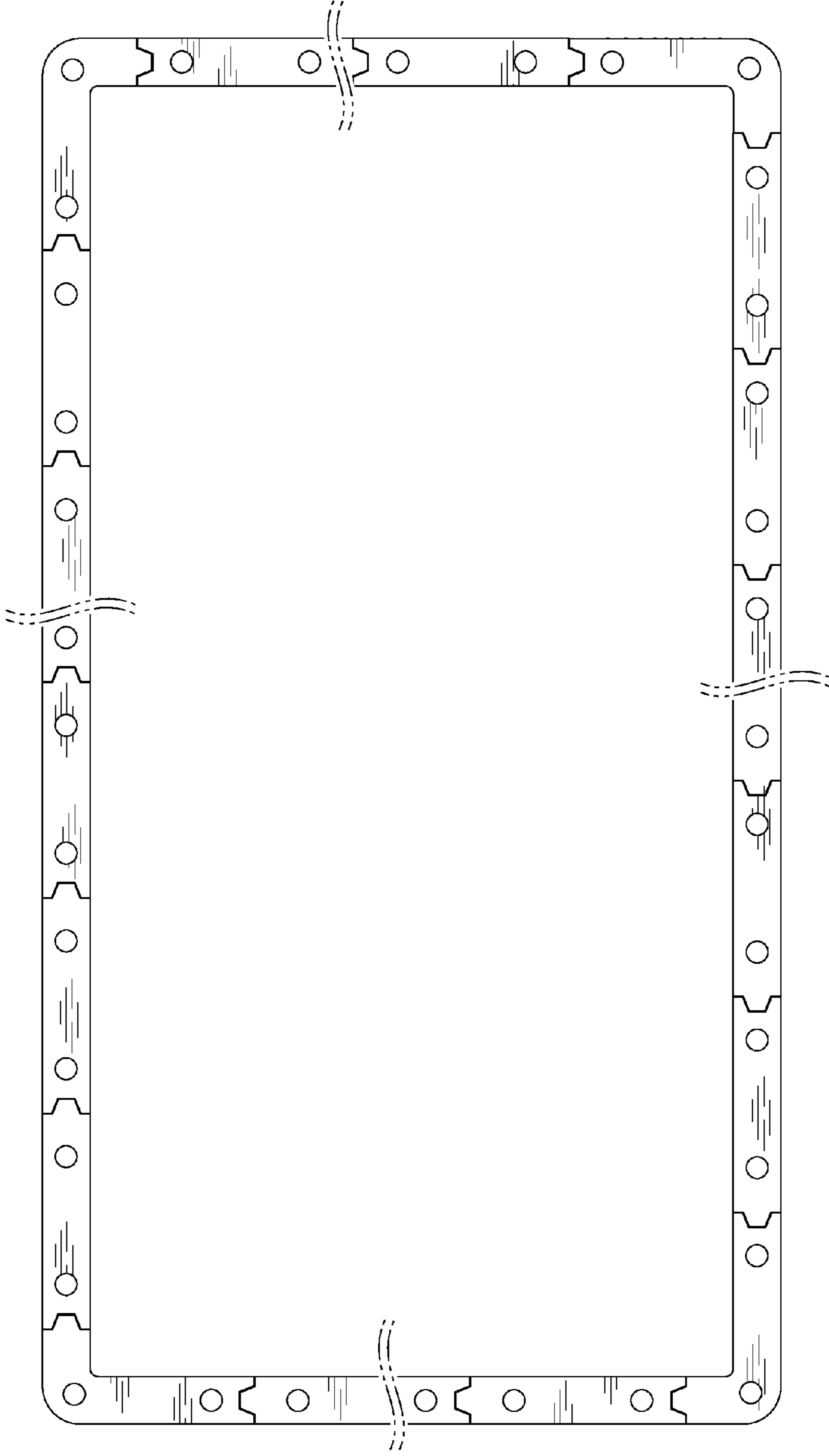

Fig. 27

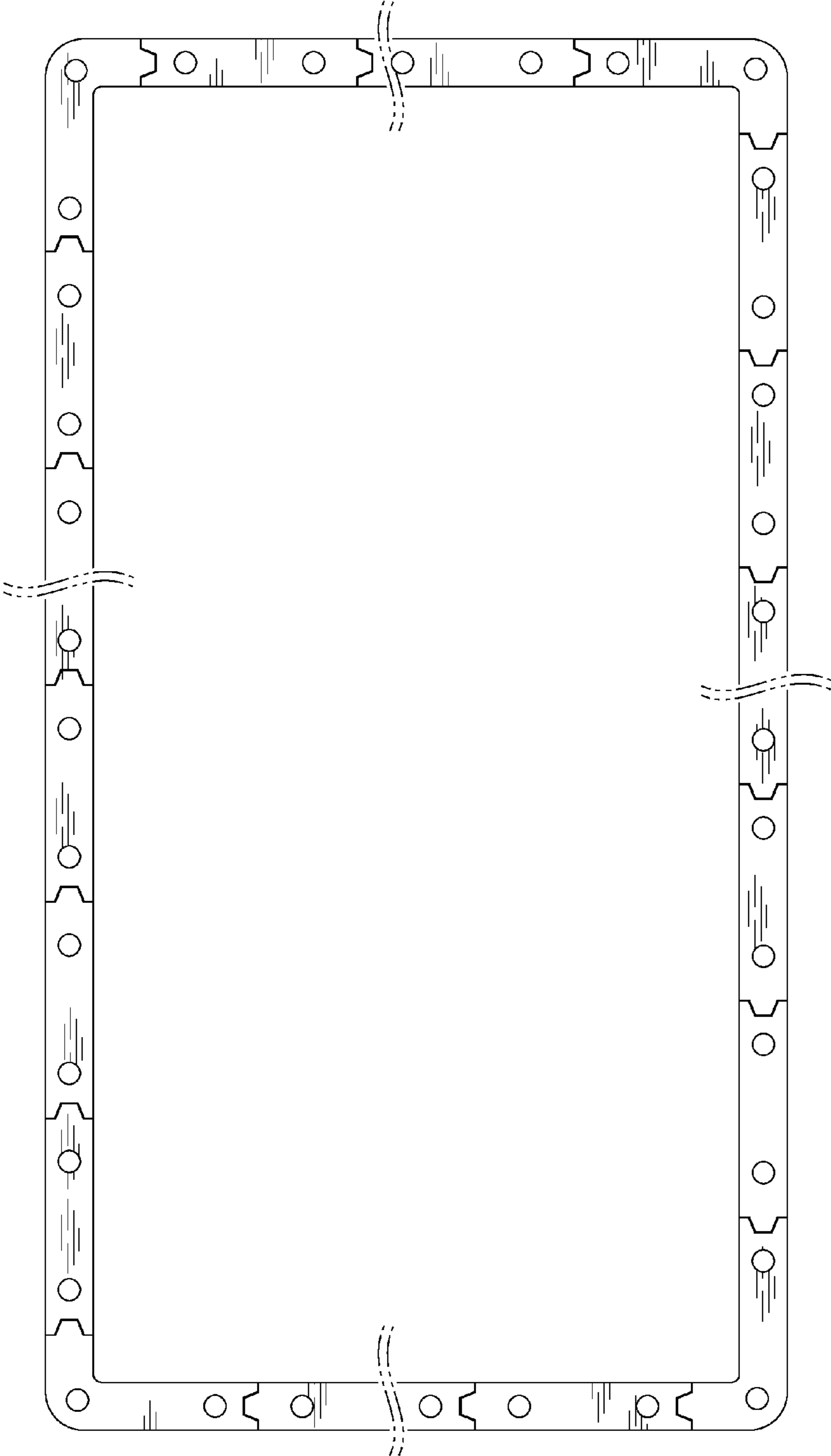

Fig. 28

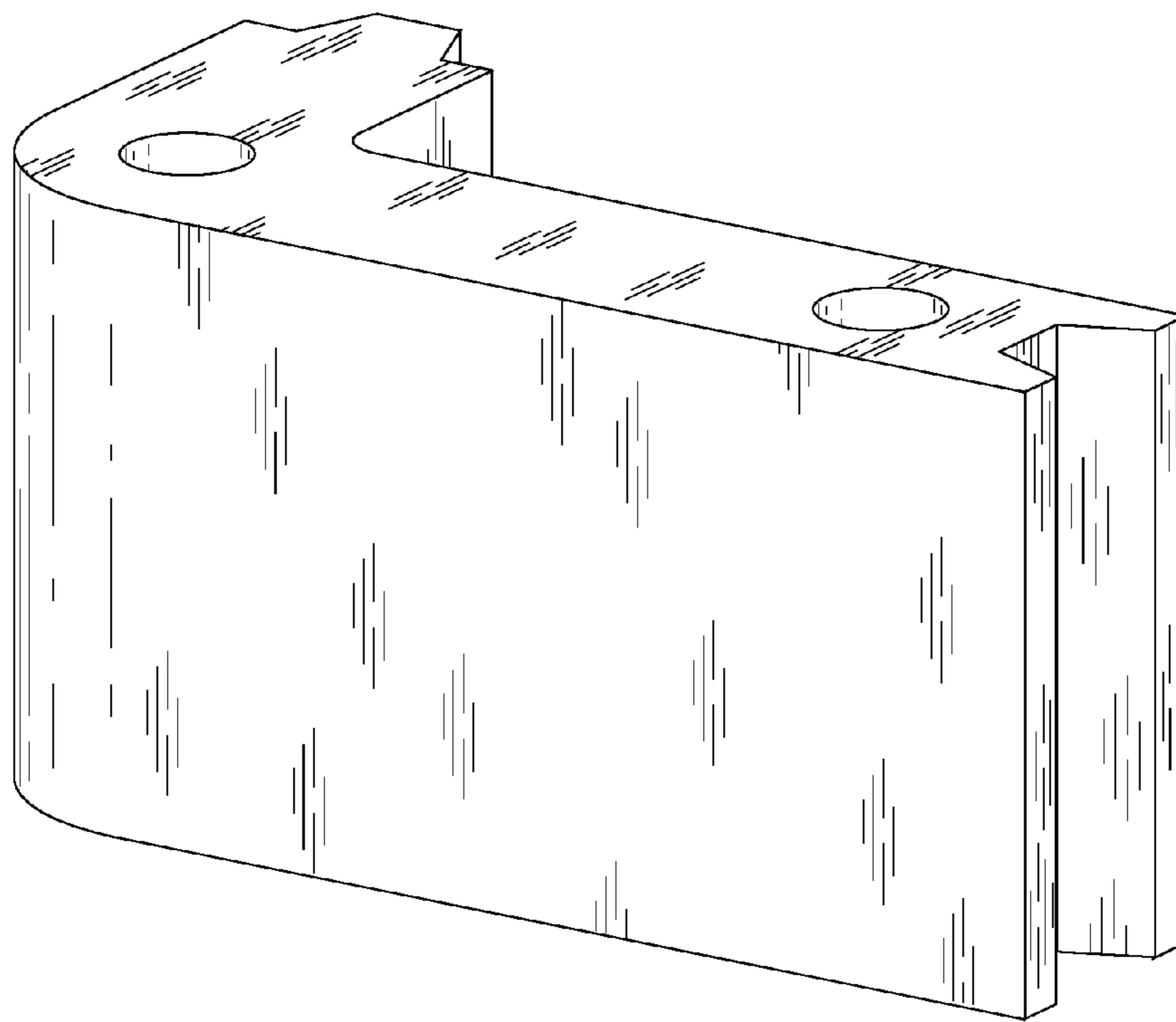

Fig. 29

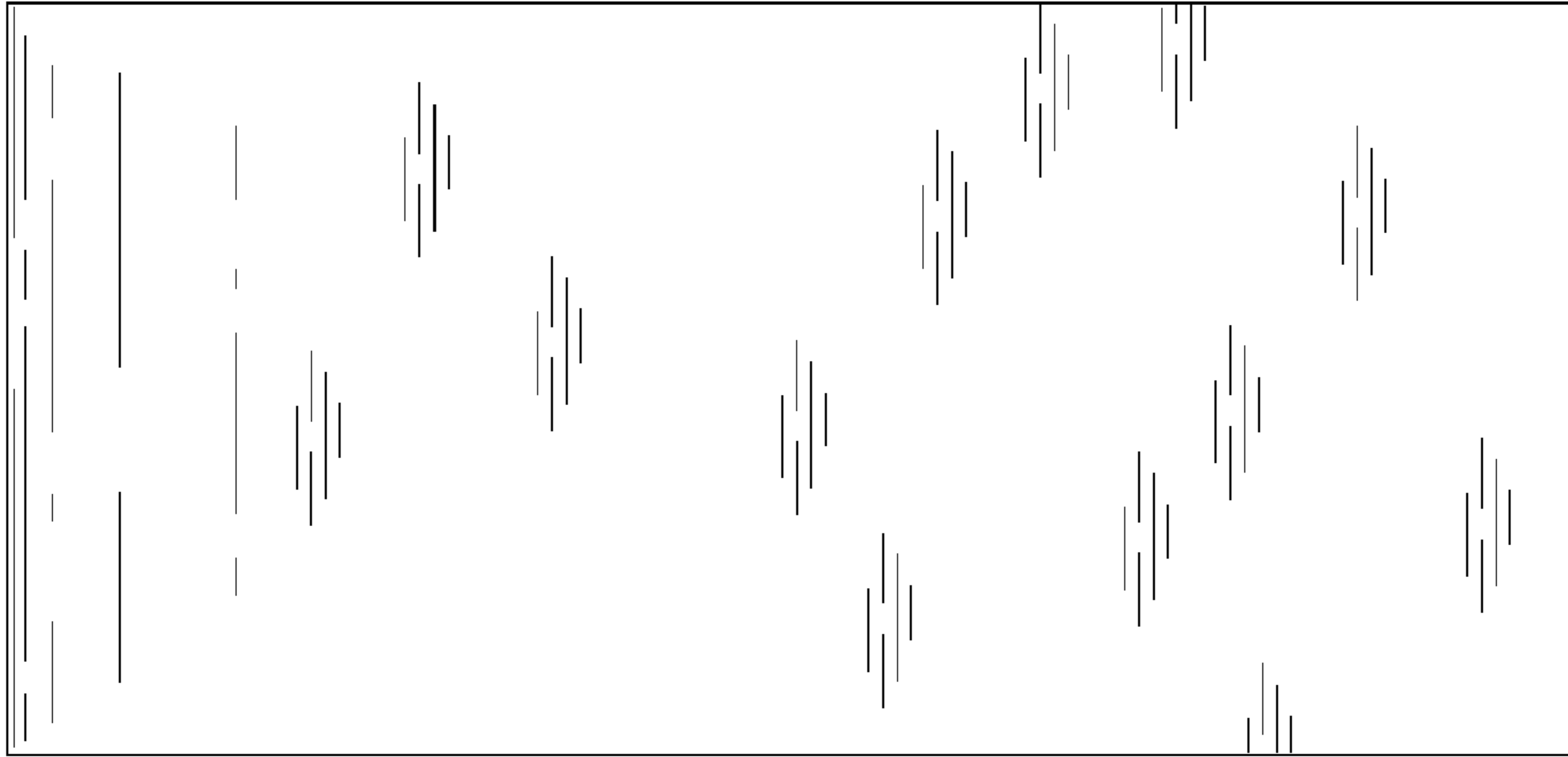

Fig. 30

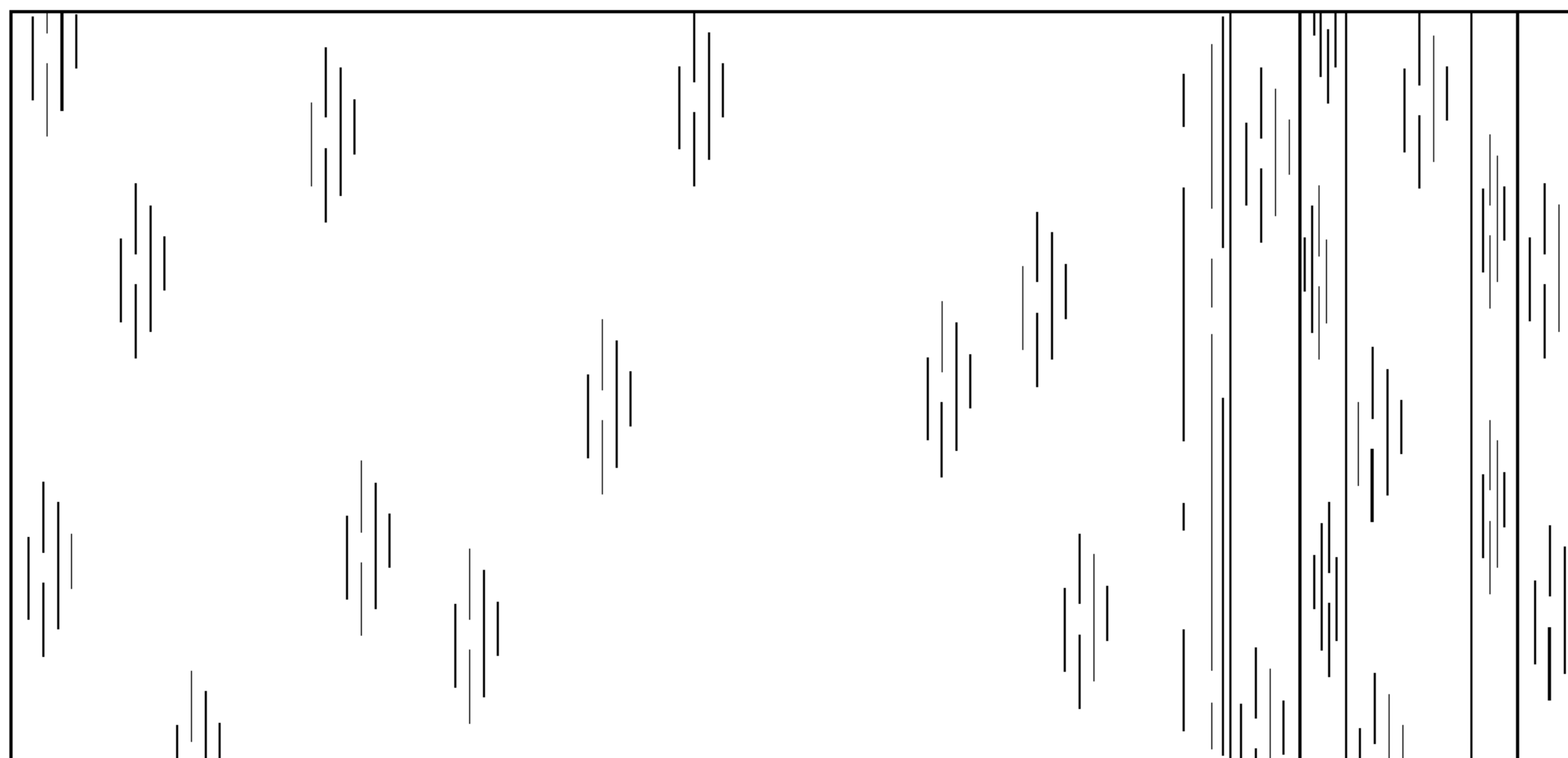

Fig. 31

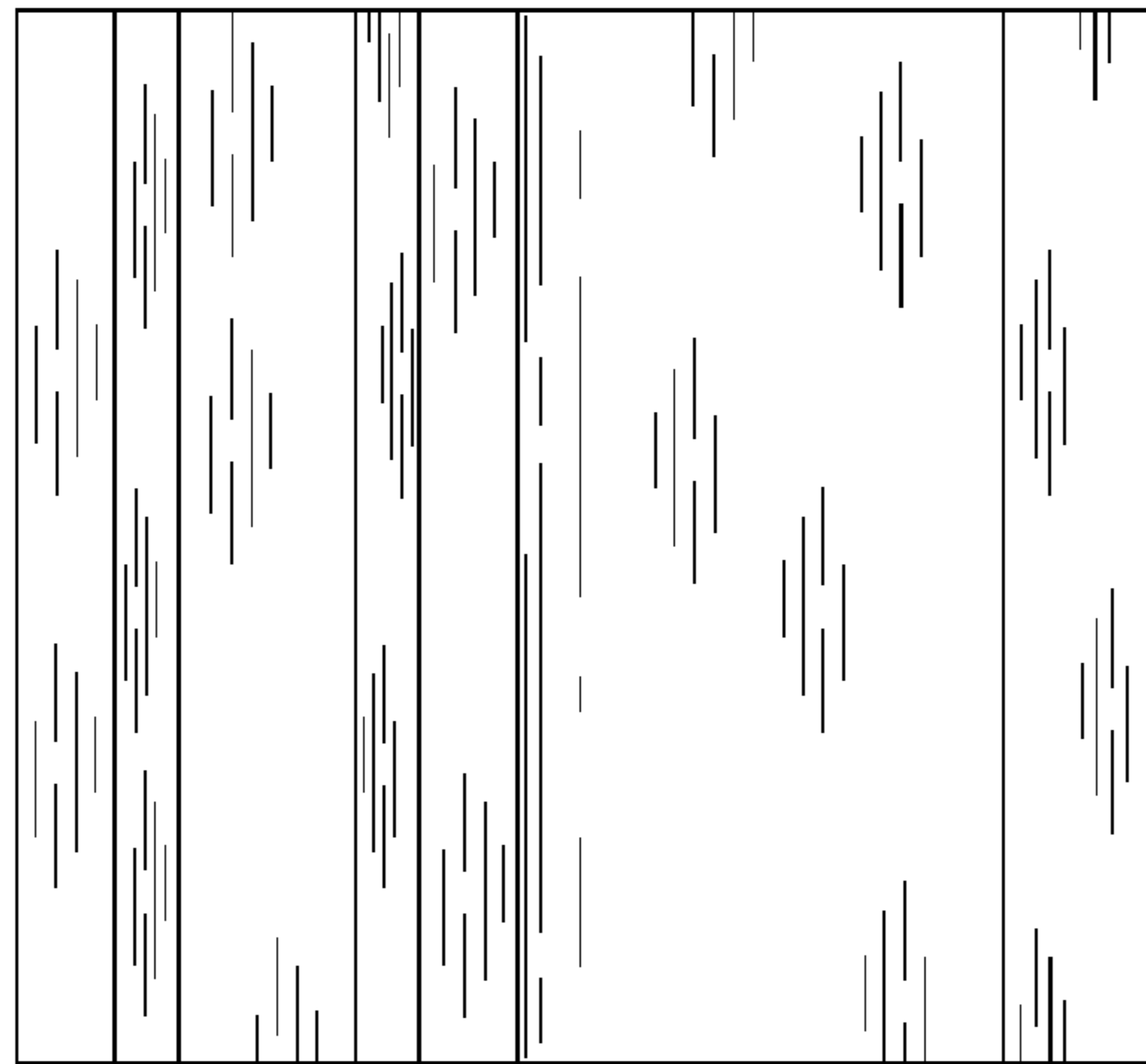

Fig. 32

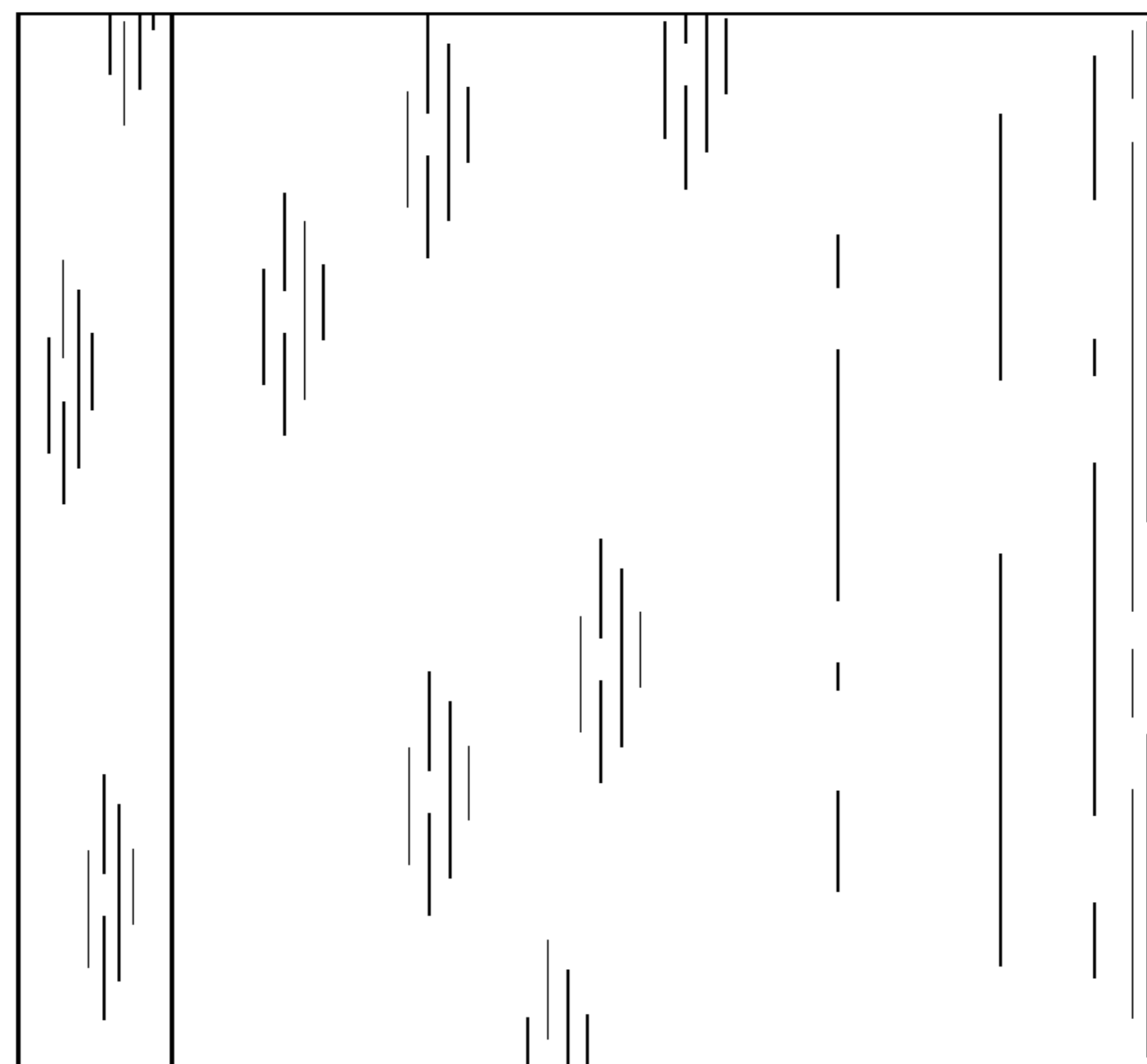

Fig. 33

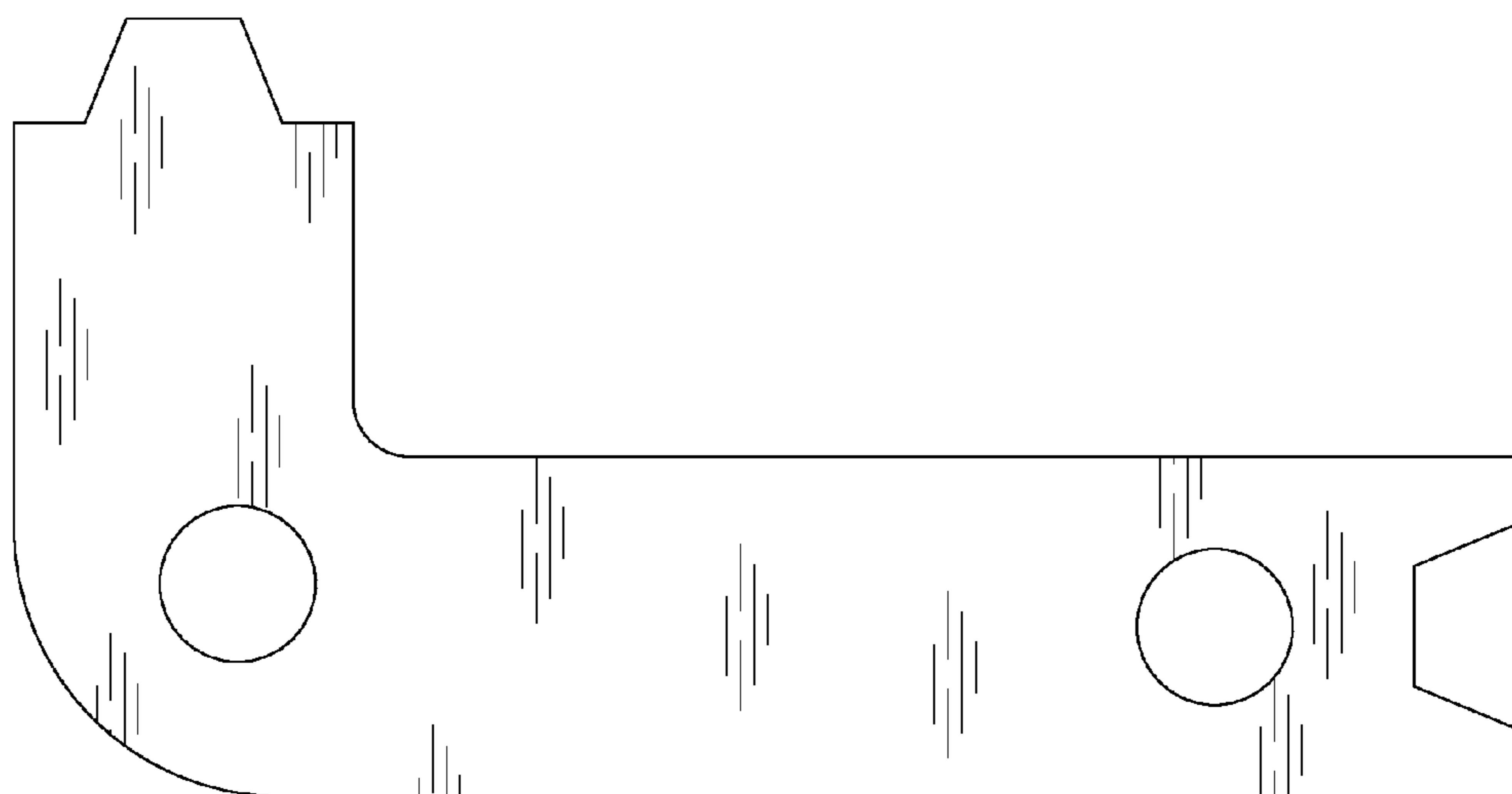

Fig. 34



Fig. 35

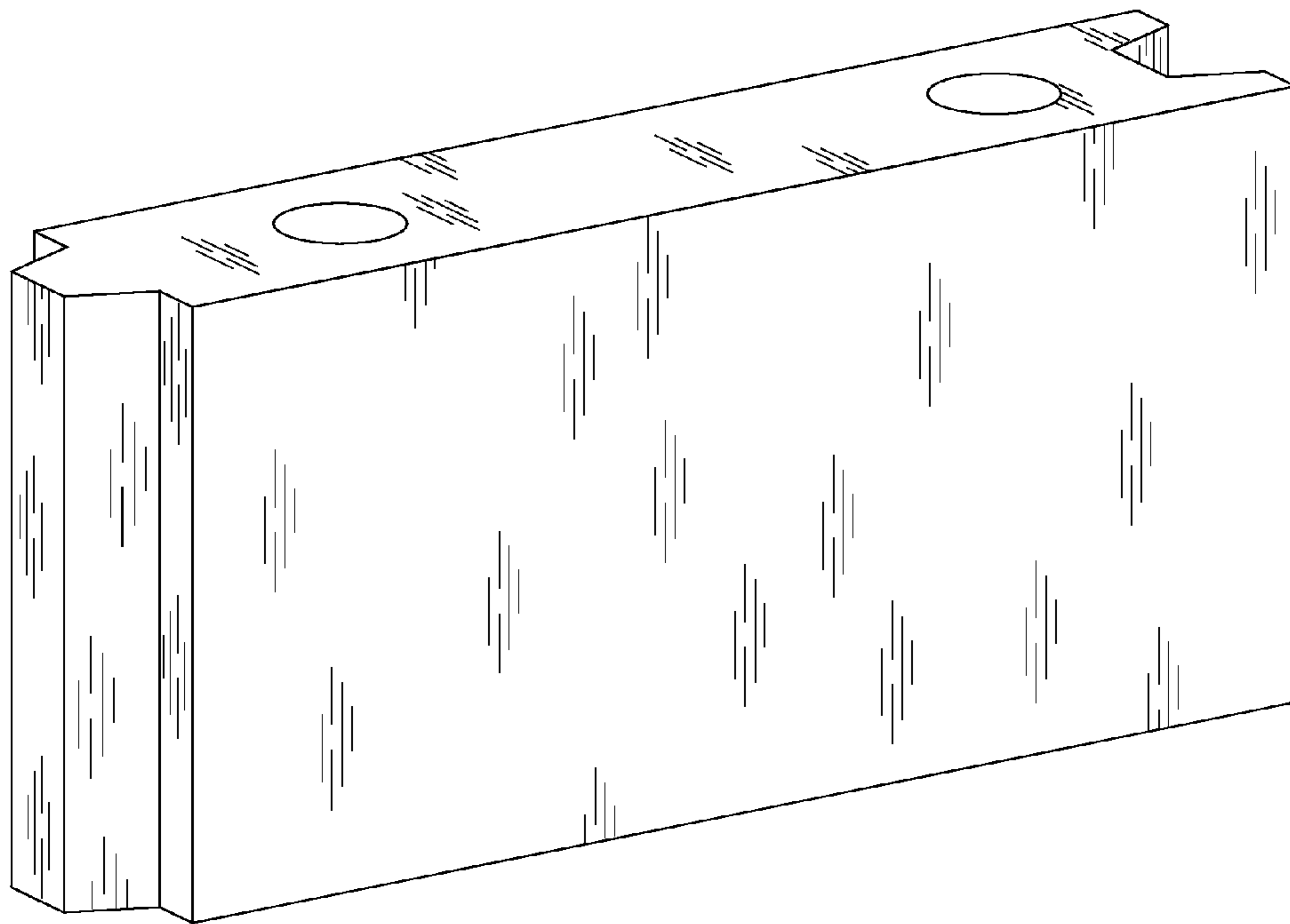

Fig. 36



Fig. 37

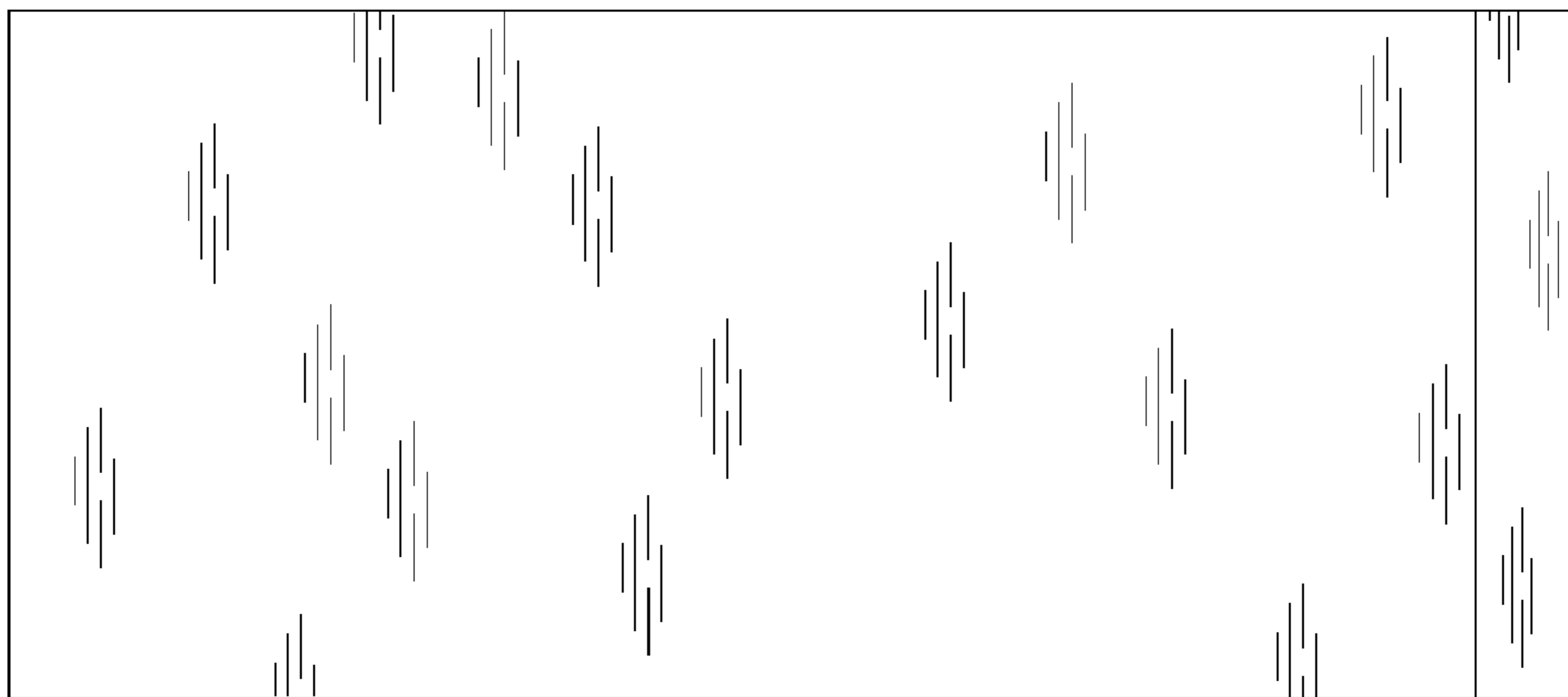

Fig. 38

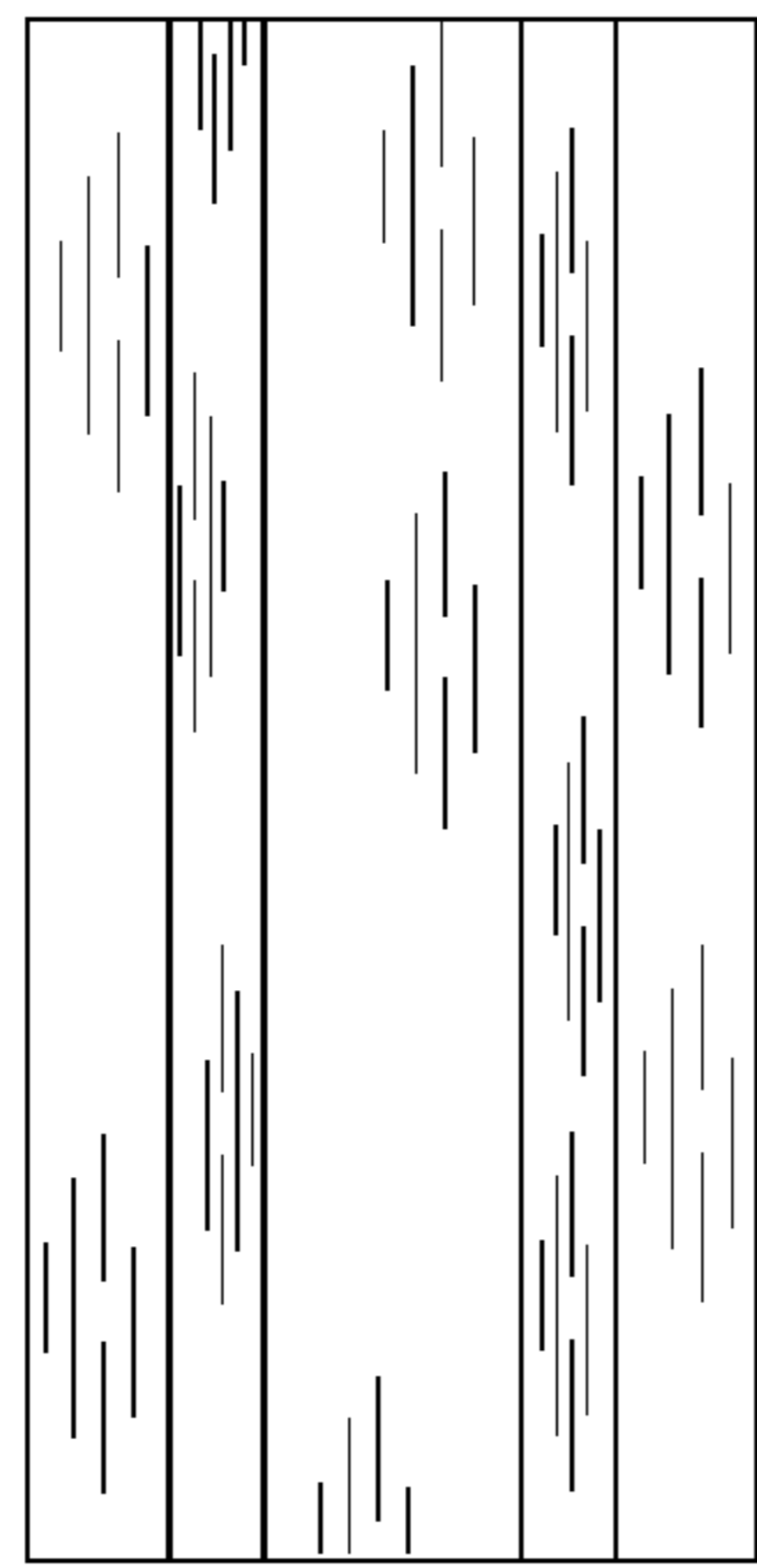

Fig. 39

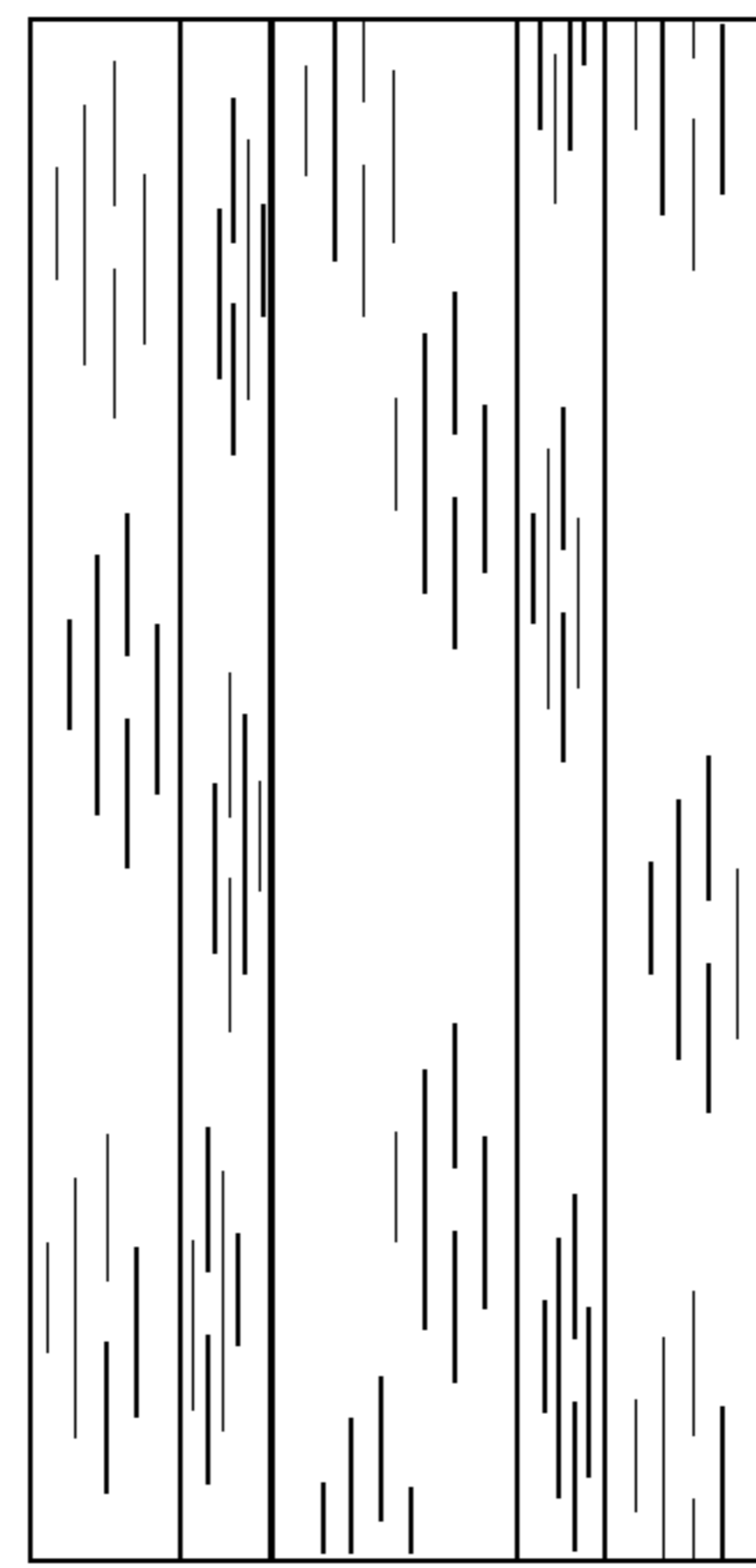

Fig. 40

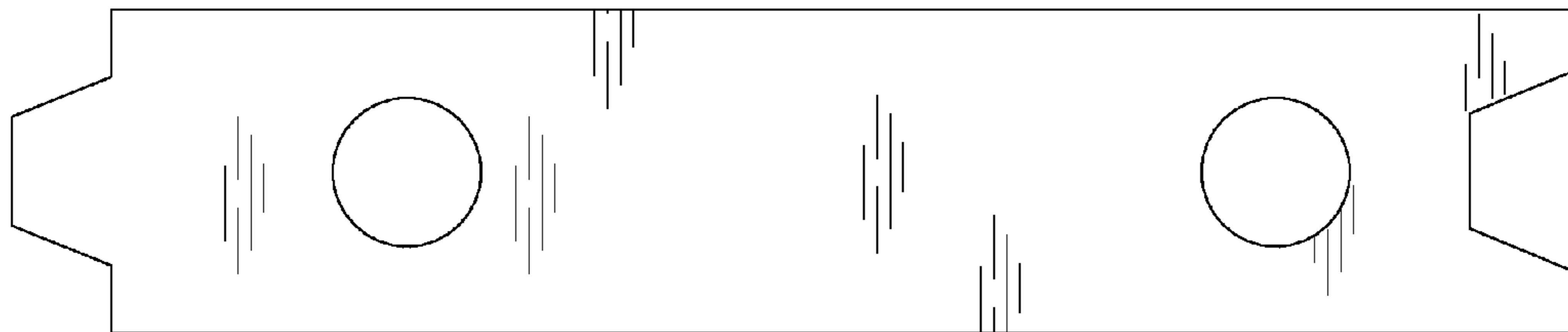

Fig. 41

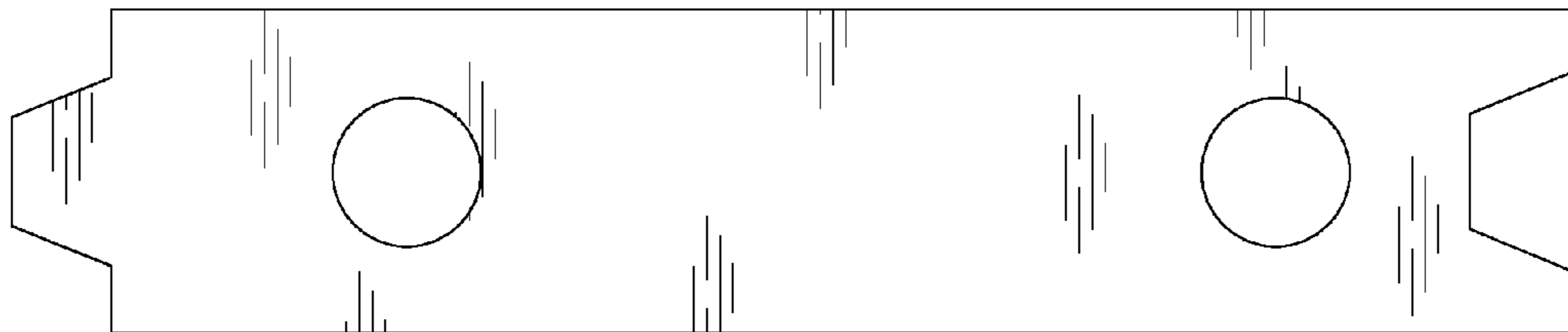

Fig. 42