



US00D724318S

(12) **United States Design Patent**  
**Myer**

(10) **Patent No.:** **US D724,318 S**  
(45) **Date of Patent:** **\*\* Mar. 17, 2015**

(54) **TACKLE BAG**

D674,187 S \* 1/2013 Jobert ..... D3/243

(71) Applicant: **Roy Myer**, Nice, CA (US)

\* cited by examiner

(72) Inventor: **Roy Myer**, Nice, CA (US)

*Primary Examiner* — Holly Baynham

(\*\*) Term: **14 Years**

(57) **CLAIM**

The ornamental design for a tackle bag, as shown and described.

(21) Appl. No.: **29/473,683**

(22) Filed: **Nov. 25, 2013**

**DESCRIPTION**

(51) **LOC (10) Cl.** ..... **03-01**

(52) **U.S. Cl.**

USPC ..... **D3/233**

(58) **Field of Classification Search**

CPC ..... A45C 1/024; A45C 3/06

USPC ..... D3/232–233, 240–243, 245–246;

150/100, 103–110, 113–114, 117–119

See application file for complete search history.

FIG. 1 is a perspective front view of a tackle bag;  
FIG. 2 is a front elevation view of the tackle bag;  
FIG. 3 is a rear elevation view of the tackle bag;  
FIG. 4 is a left side elevation view of the tackle bag;  
FIG. 5 is a right side elevation view of the tackle bag;  
FIG. 6 is a top plan view of the tackle bag;  
FIG. 7 is a bottom plan view of the tackle bag; and,  
FIG. 8 is a perspective front view of the tackle box unfolded.  
The broken lines showing fishing supplies are for the purposes of illustrating environment and form no part of the claimed design.

(56) **References Cited**

U.S. PATENT DOCUMENTS

D662,318 S \* 6/2012 Guichot ..... D3/243

**1 Claim, 4 Drawing Sheets**

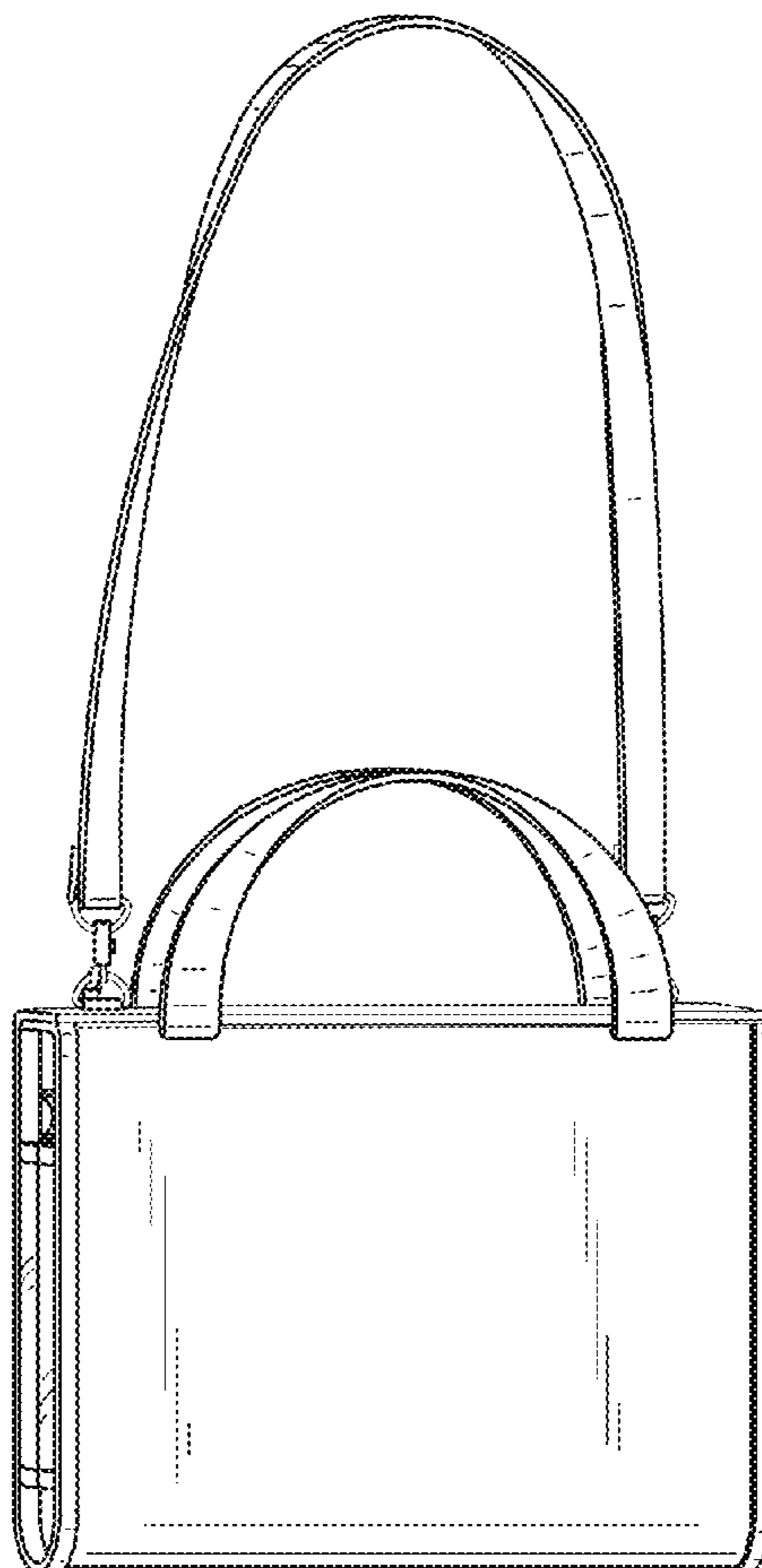

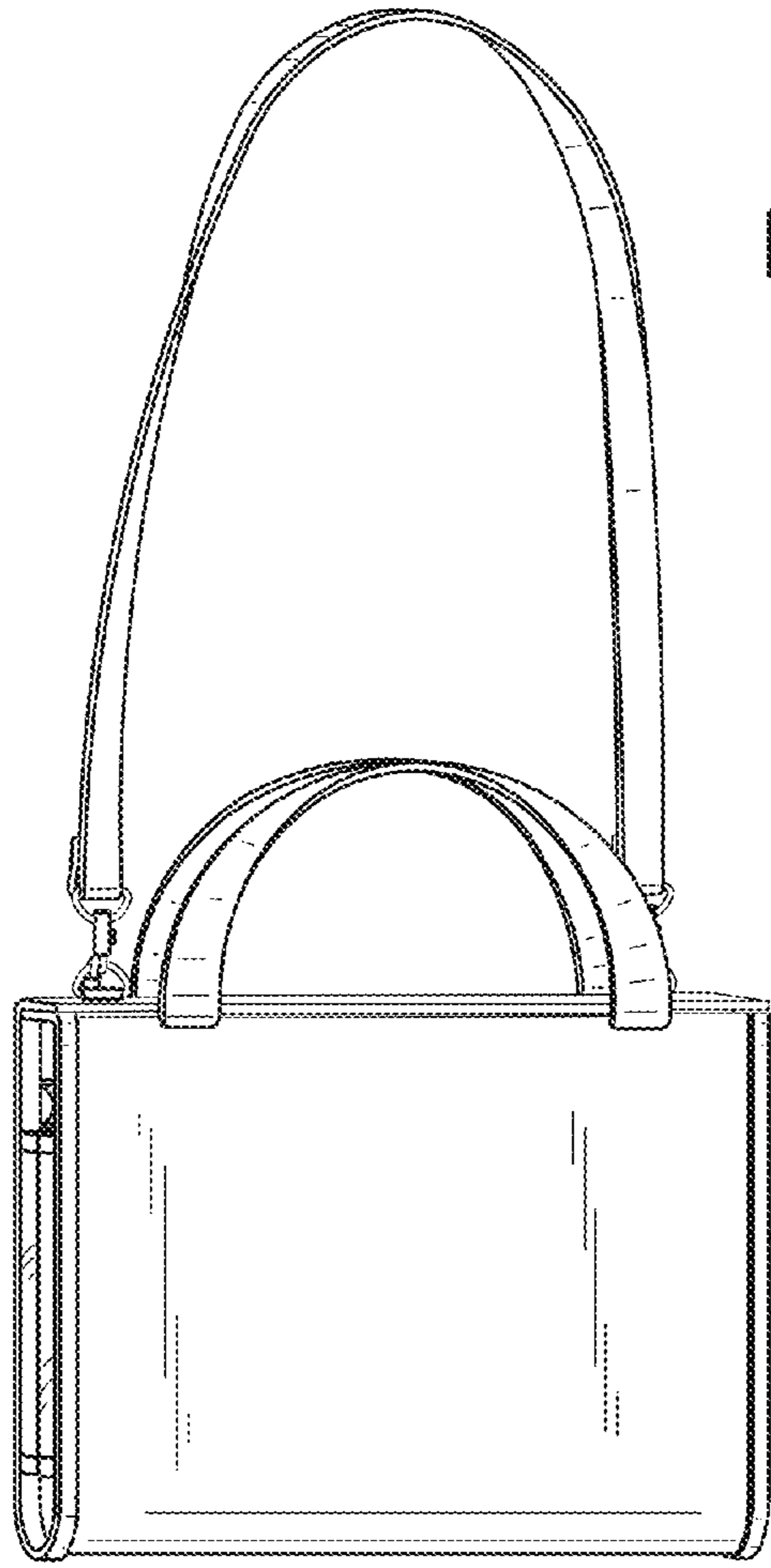

FIG. 1

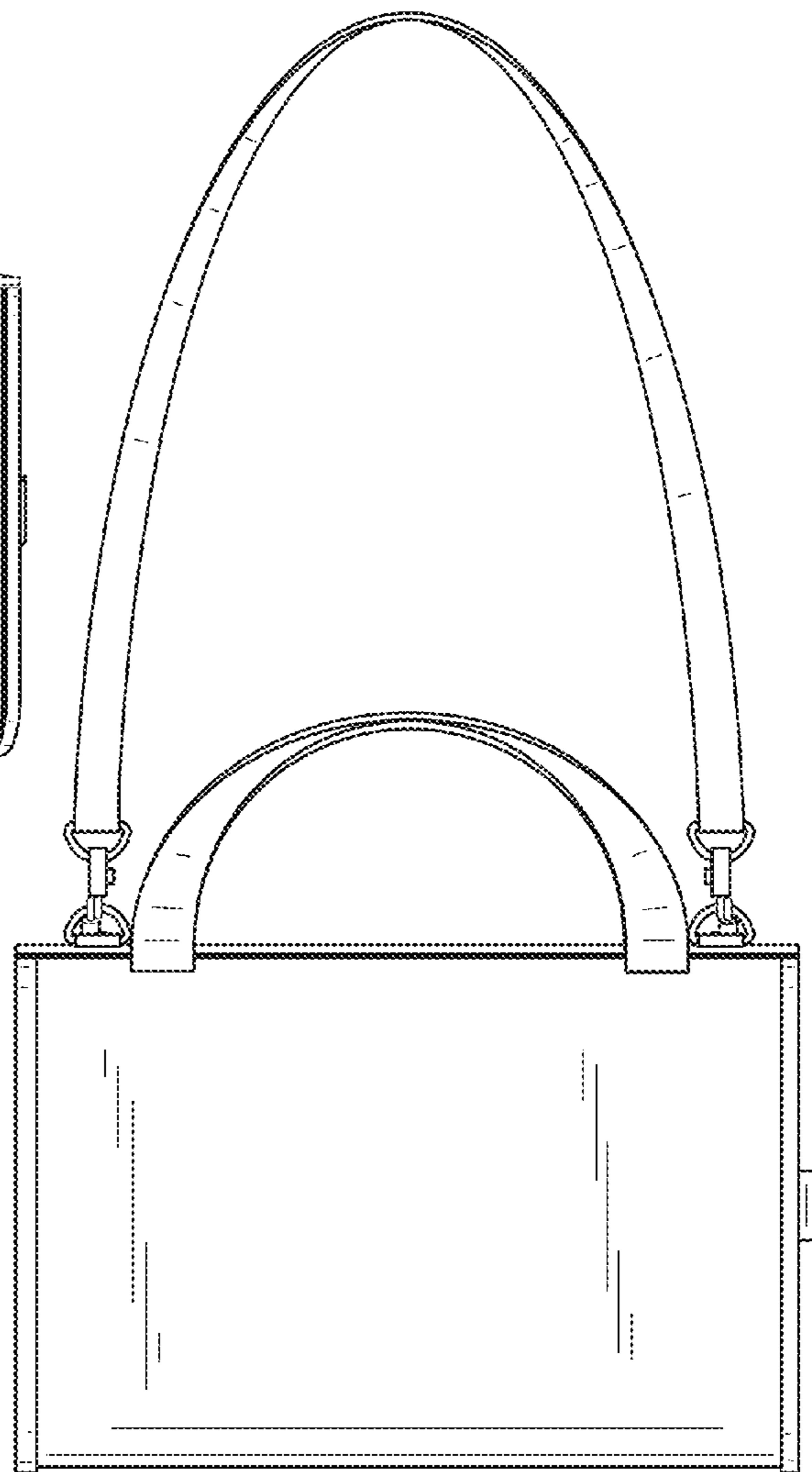

FIG. 2

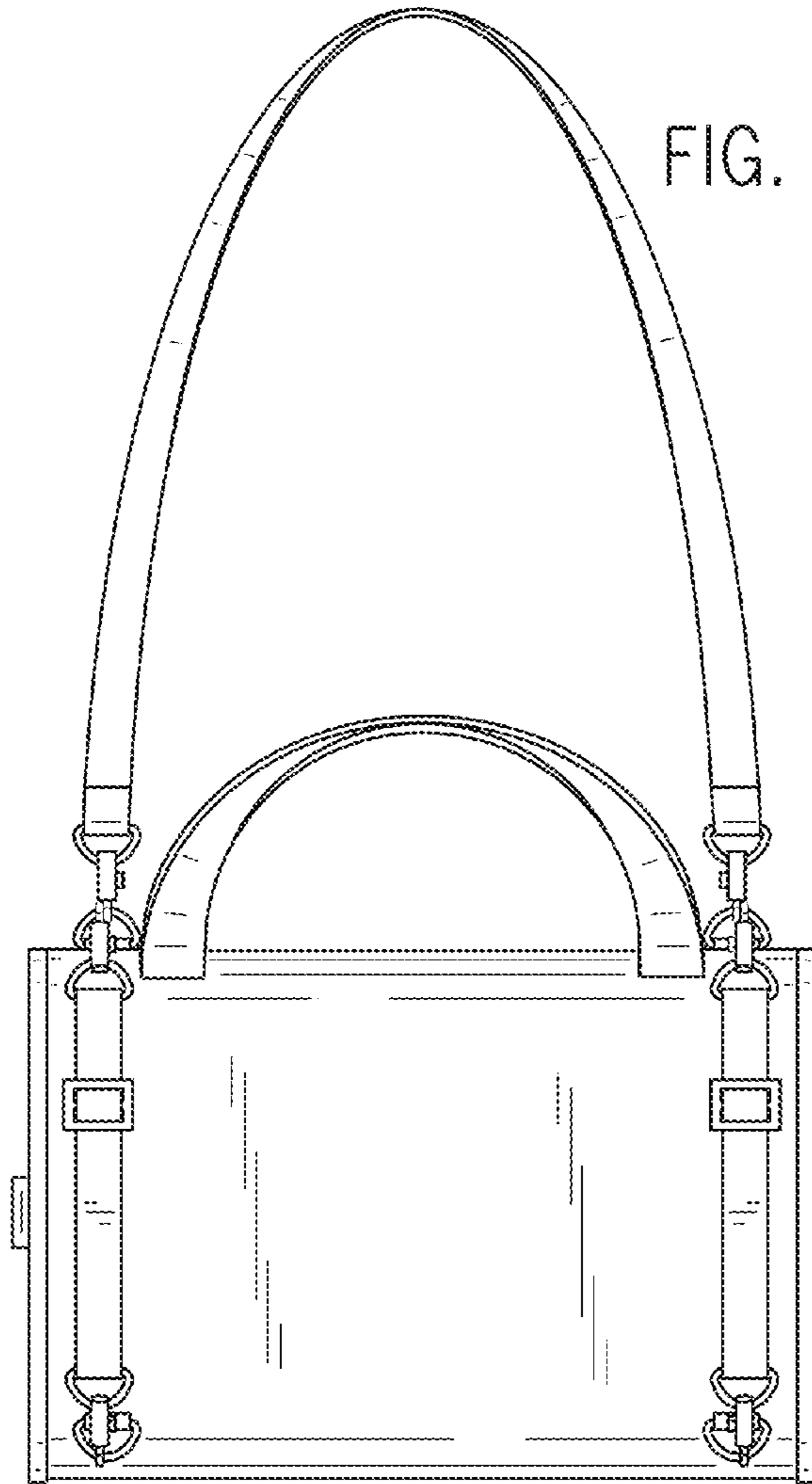

FIG. 3

FIG. 4

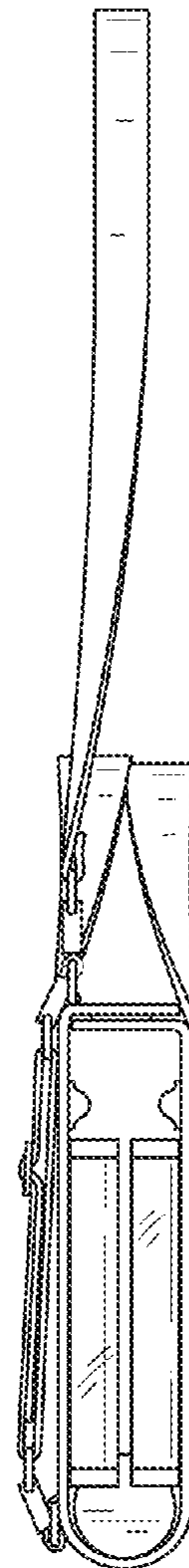
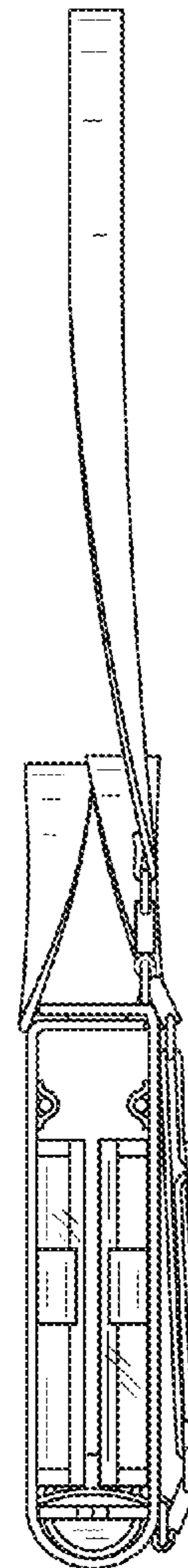

FIG. 5



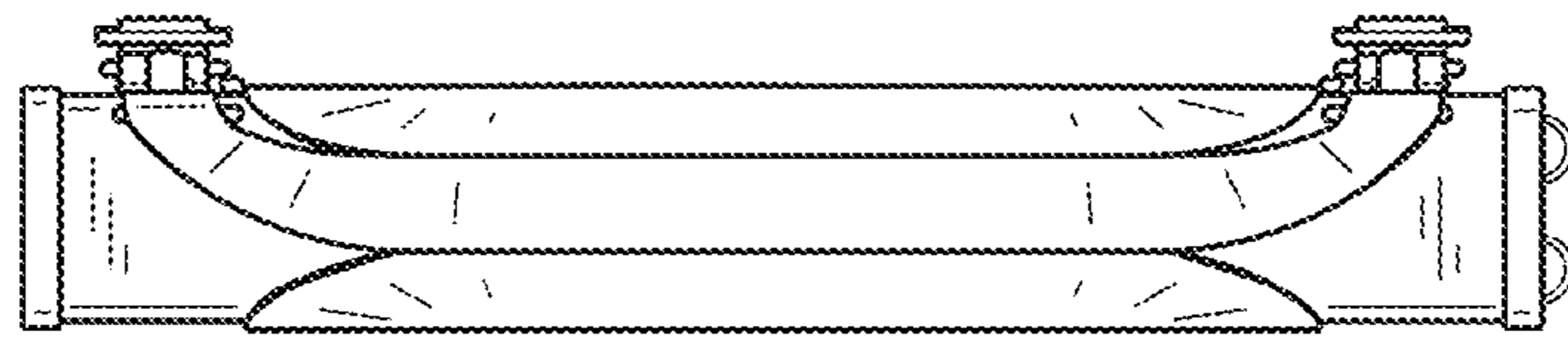

FIG. 6

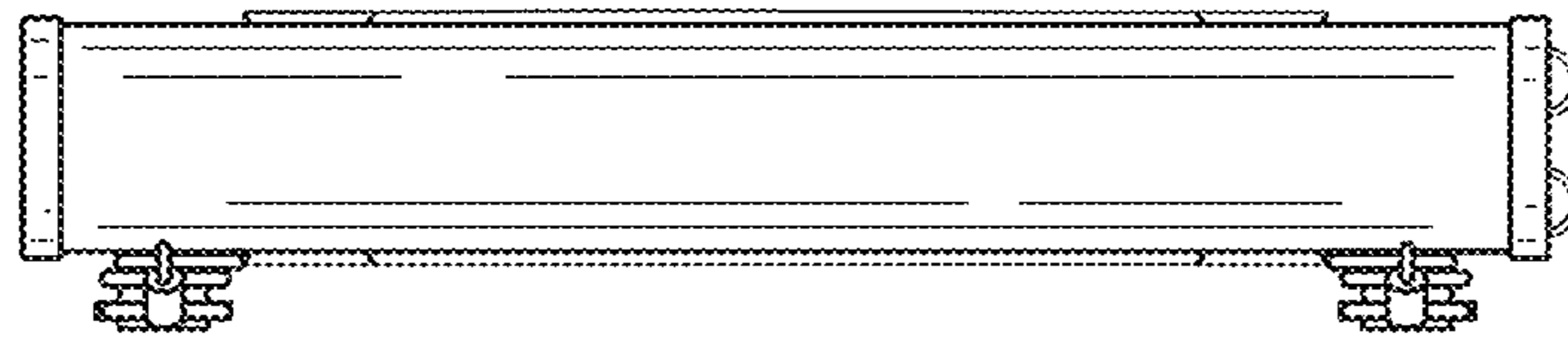

FIG. 7

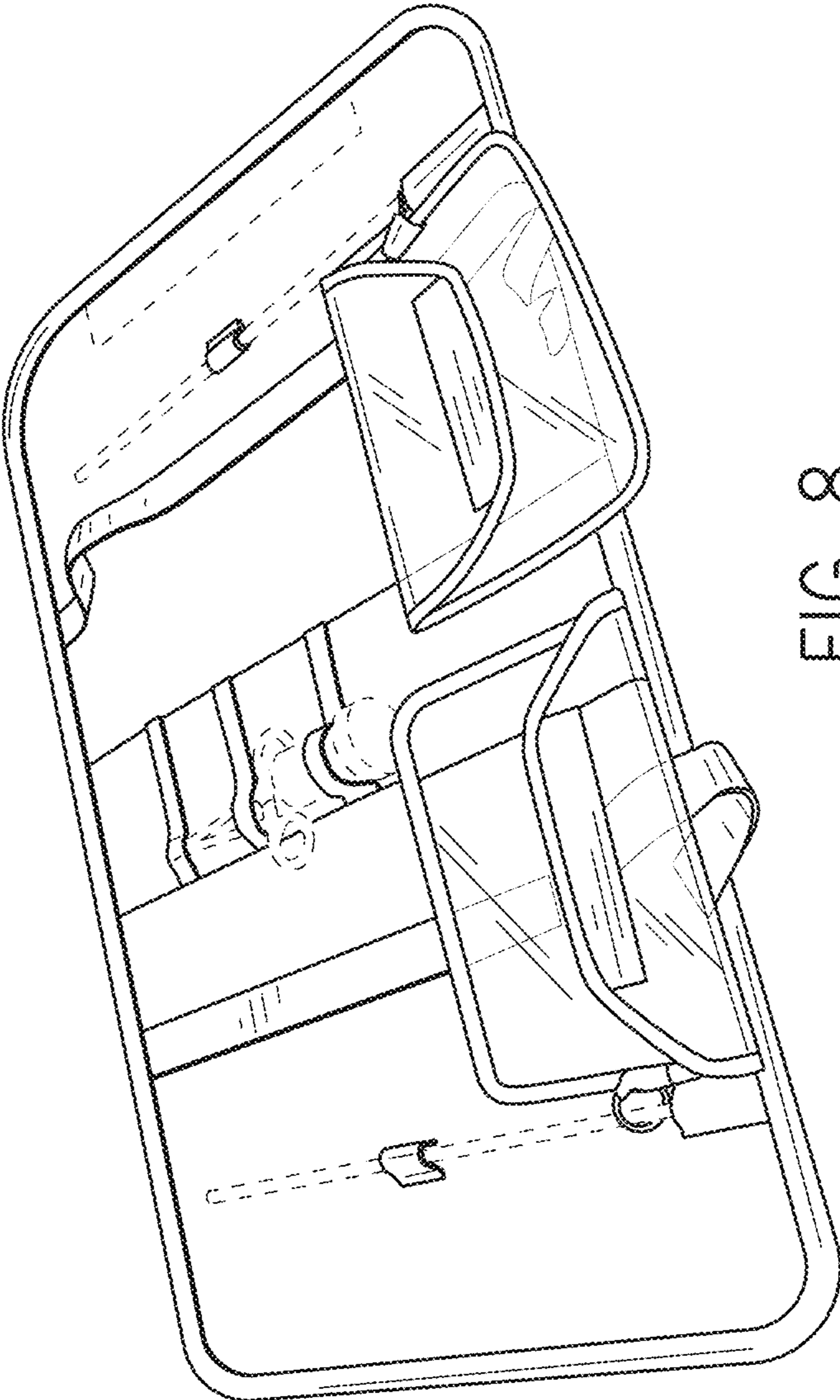

FIG. 8