

US00D724223S

(12) **United States Design Patent**
Nishiyama et al.

(10) **Patent No.:** **US D724,223 S**
(45) **Date of Patent:** **** Mar. 10, 2015**

(54) **TEST METER**

(71) Applicant: **ARKRAY, Inc.**, Kyoto (JP)
(72) Inventors: **Hisashi Nishiyama**, Kyoto (JP); **Yuji Kurata**, Kyoto (JP); **Yeongkyu Yoo**, Seoul (KR); **Yeongduk Song**, Seoul (KR); **Sunman Kwon**, Seoul (KR)
(73) Assignee: **ARKRAY, Inc.**, Kyoto (JP)

(**) Term: **14 Years**

(21) Appl. No.: **29/483,653**

(22) Filed: **Feb. 28, 2014**

(30) **Foreign Application Priority Data**

Sep. 4, 2013 (JP) 2013-020408

(51) **LOC (10) Cl.** **24-01**

(52) **U.S. Cl.**
USPC **D24/169**

(58) **Field of Classification Search**
USPC D24/216, 223, 231, 232, 107, 169, 186;
D10/81; 422/68.1, 420, 500;
435/287.1, 287.3; 436/43, 45, 47;
600/309, 365, 368, 583, 584

See application file for complete search history.

(56) **References Cited**

U.S. PATENT DOCUMENTS

D406,895	S	*	3/1999	Byrd et al.	D24/169
D545,438	S	*	6/2007	Huang et al.	D24/186
D590,063	S	*	4/2009	Garthoff et al.	D24/186
D595,415	S	*	6/2009	Fukuzawa	D24/186
D670,811	S	*	11/2012	Fukuzawa	D24/169
D690,422	S	*	9/2013	Oka	D24/169
D696,404	S	*	12/2013	Golnik et al.	D24/169
2011/0257533	A1	*	10/2011	Nishiyama	600/476

* cited by examiner

Primary Examiner — Anhdao Doan

(74) *Attorney, Agent, or Firm* — Studebaker & Brackett PC

(57) **CLAIM**

The ornamental design for a test meter, as shown and described.

DESCRIPTION

FIG. 1 is a front elevational view of the test meter;
FIG. 2 is a rear elevational view of the test meter;
FIG. 3 is a left elevational view of the test meter;
FIG. 4 is a right elevational view of the test meter;
FIG. 5 is a top plan view of the test meter;
FIG. 6 is a bottom plan view of the test meter;
FIG. 7 is a bottom frontal perspective view of the test meter;
FIG. 8 is a top frontal perspective view of the test meter;
FIG. 9 is a bottom rear perspective view of the test meter; and,
FIG. 10 is a top rear perspective view of the test meter.

1 Claim, 5 Drawing Sheets

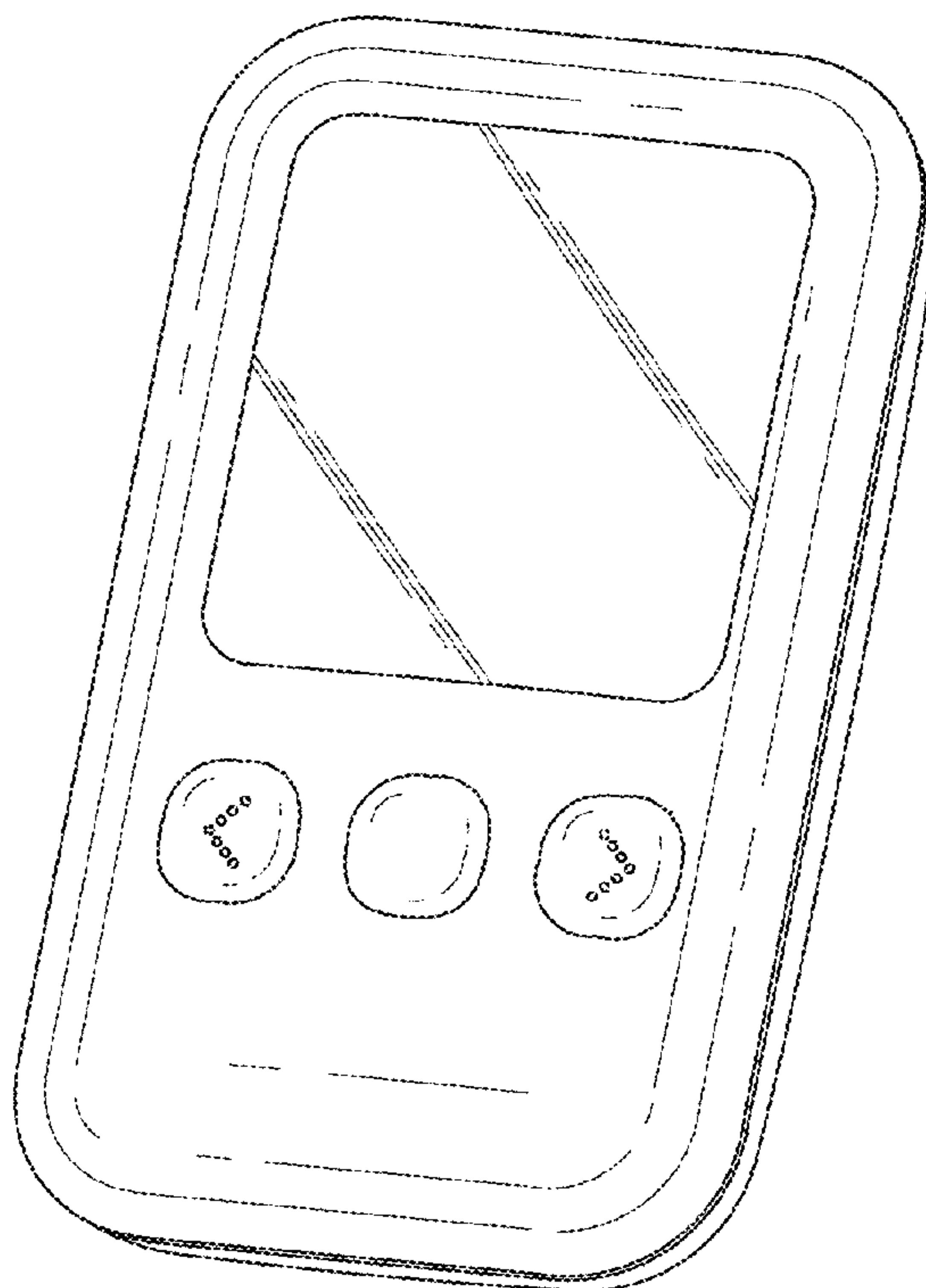

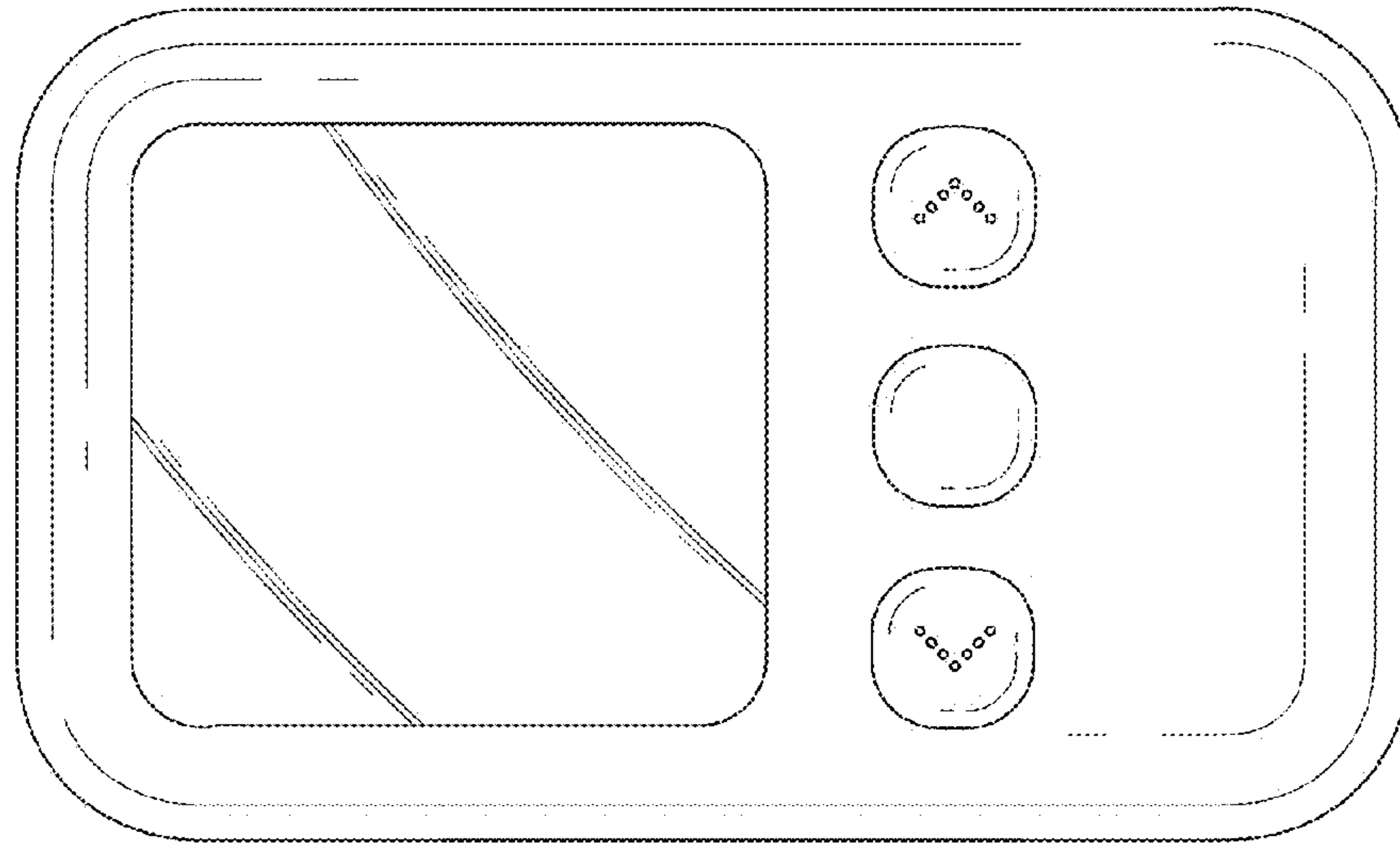

FIG. 1

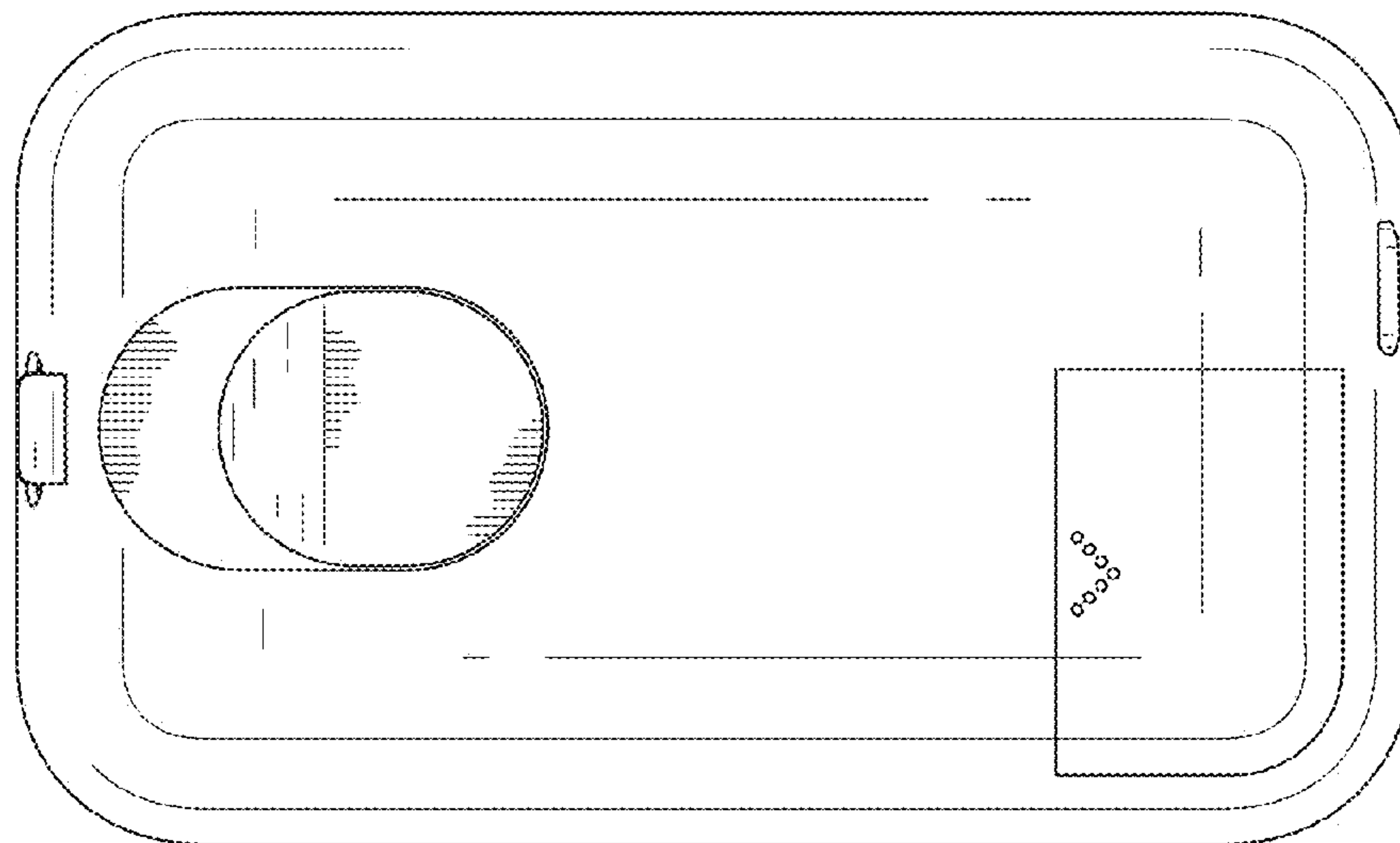

FIG. 2

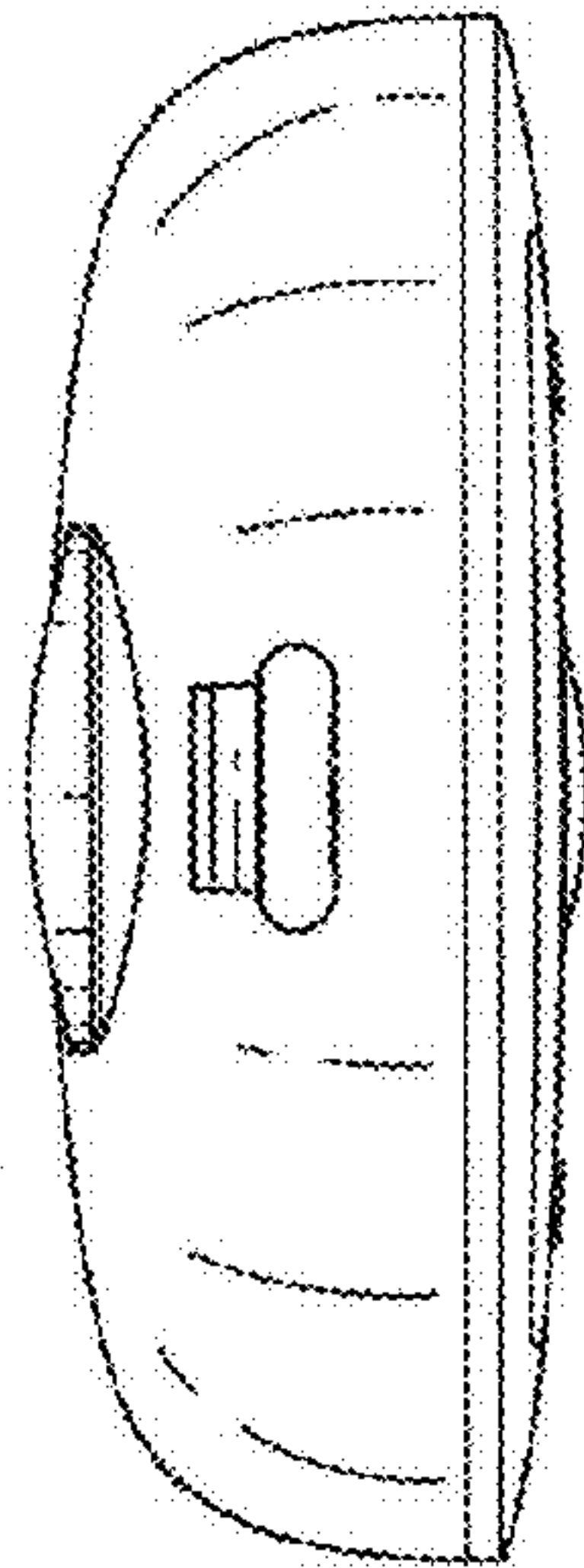

FIG. 3

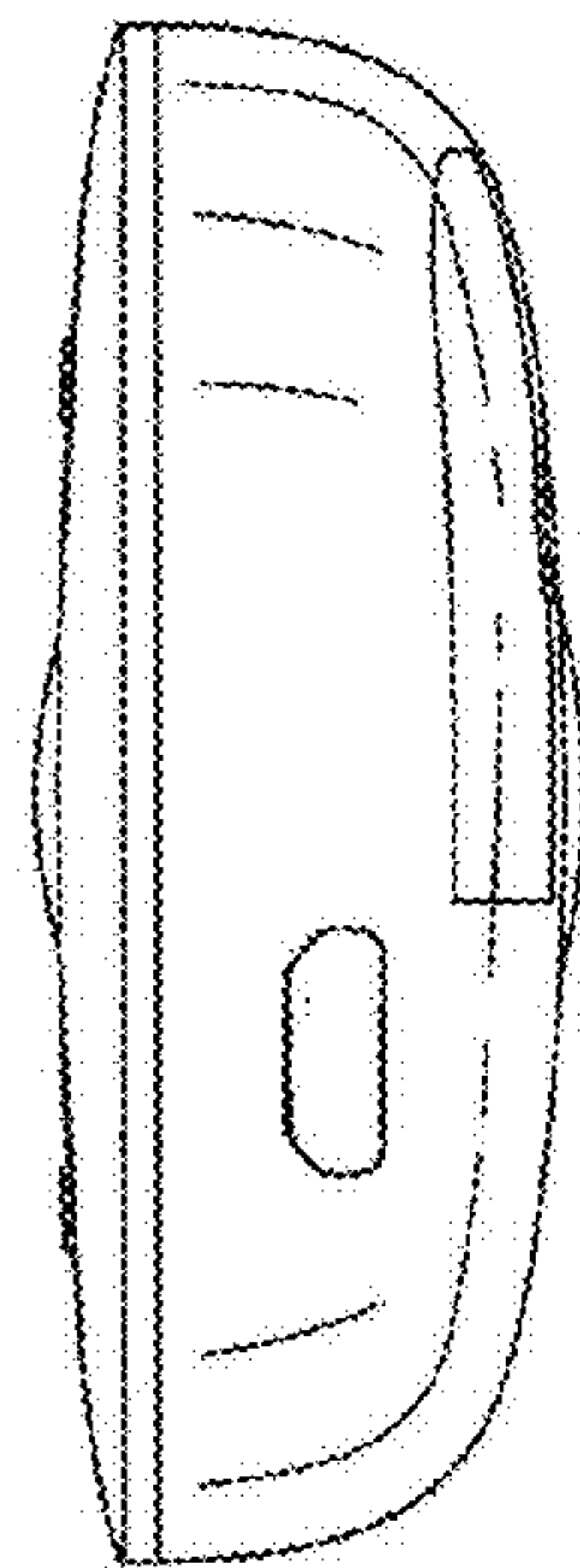

FIG. 4

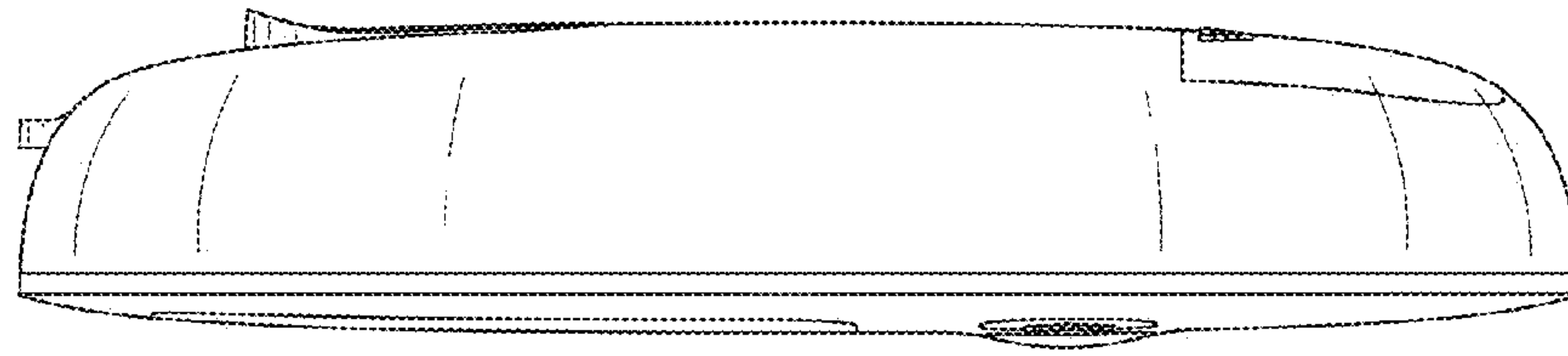

FIG. 5

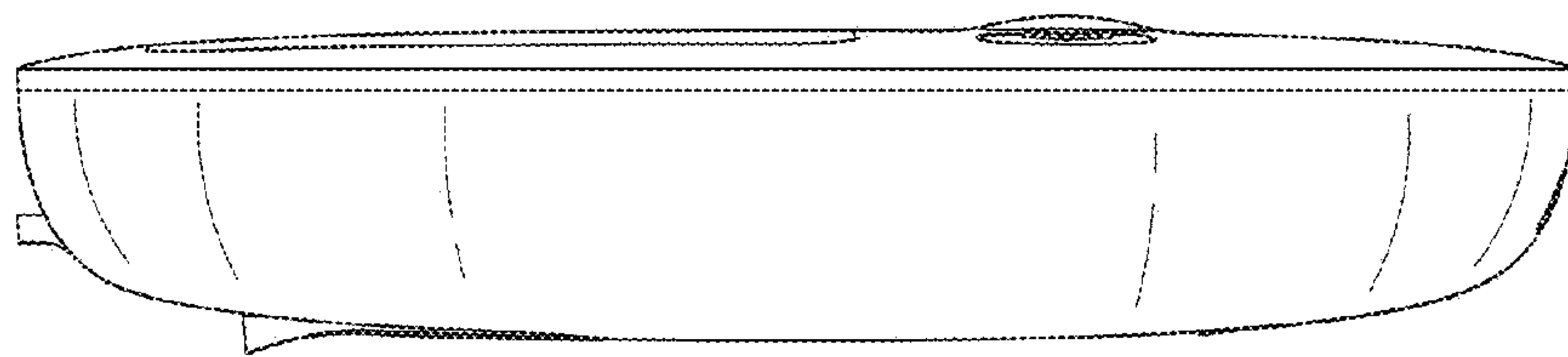

FIG. 6

FIG. 7

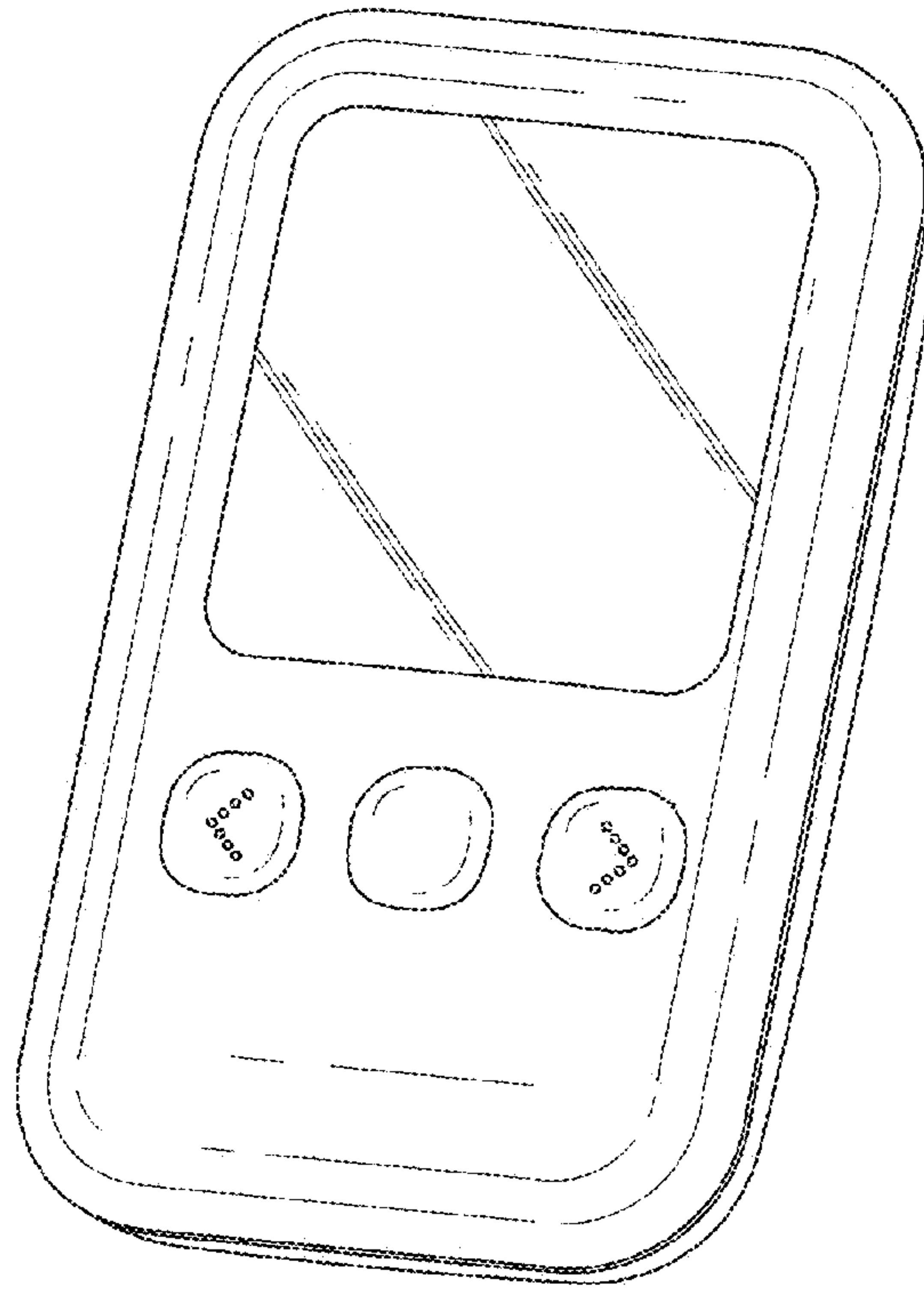

FIG. 8

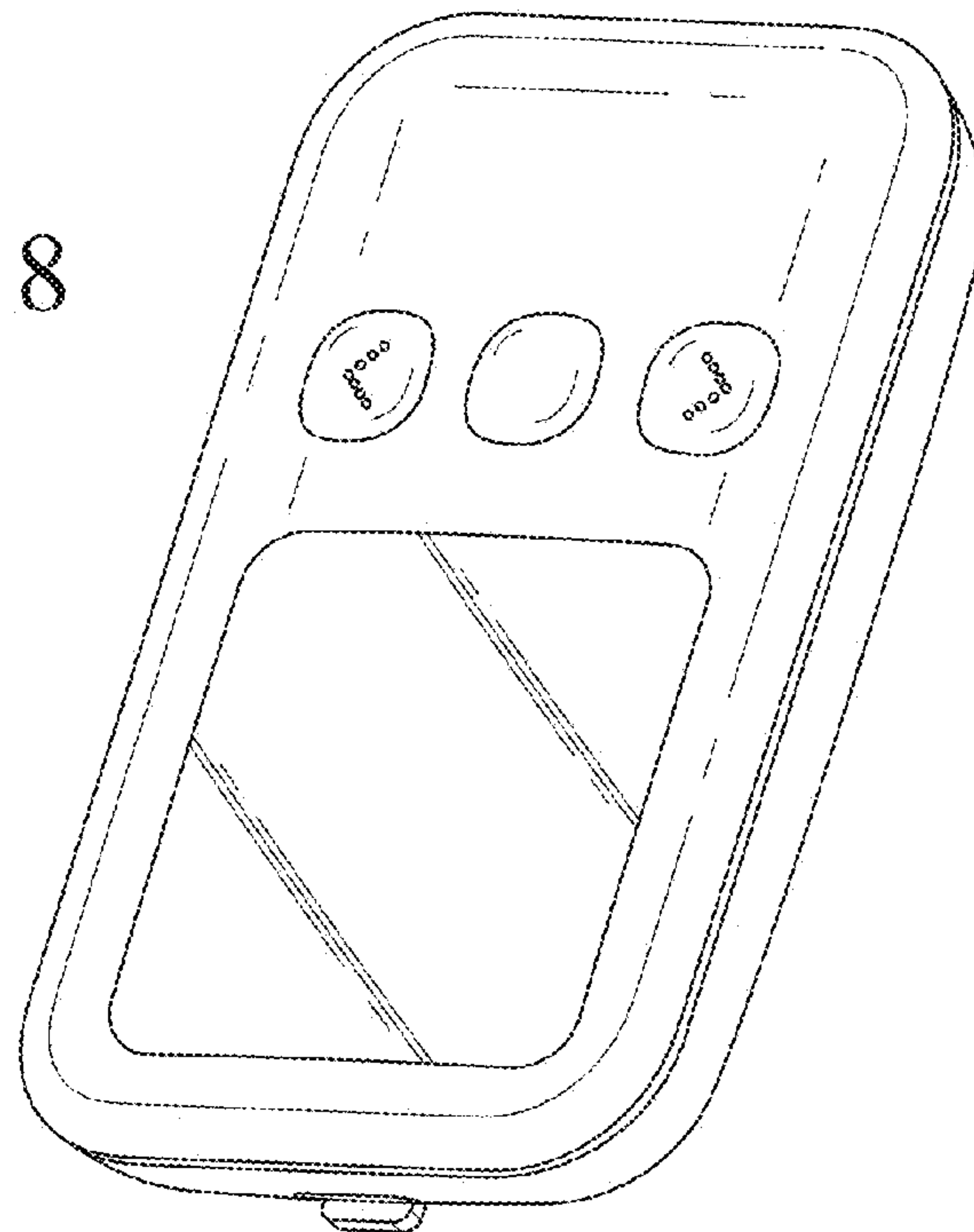

FIG. 9

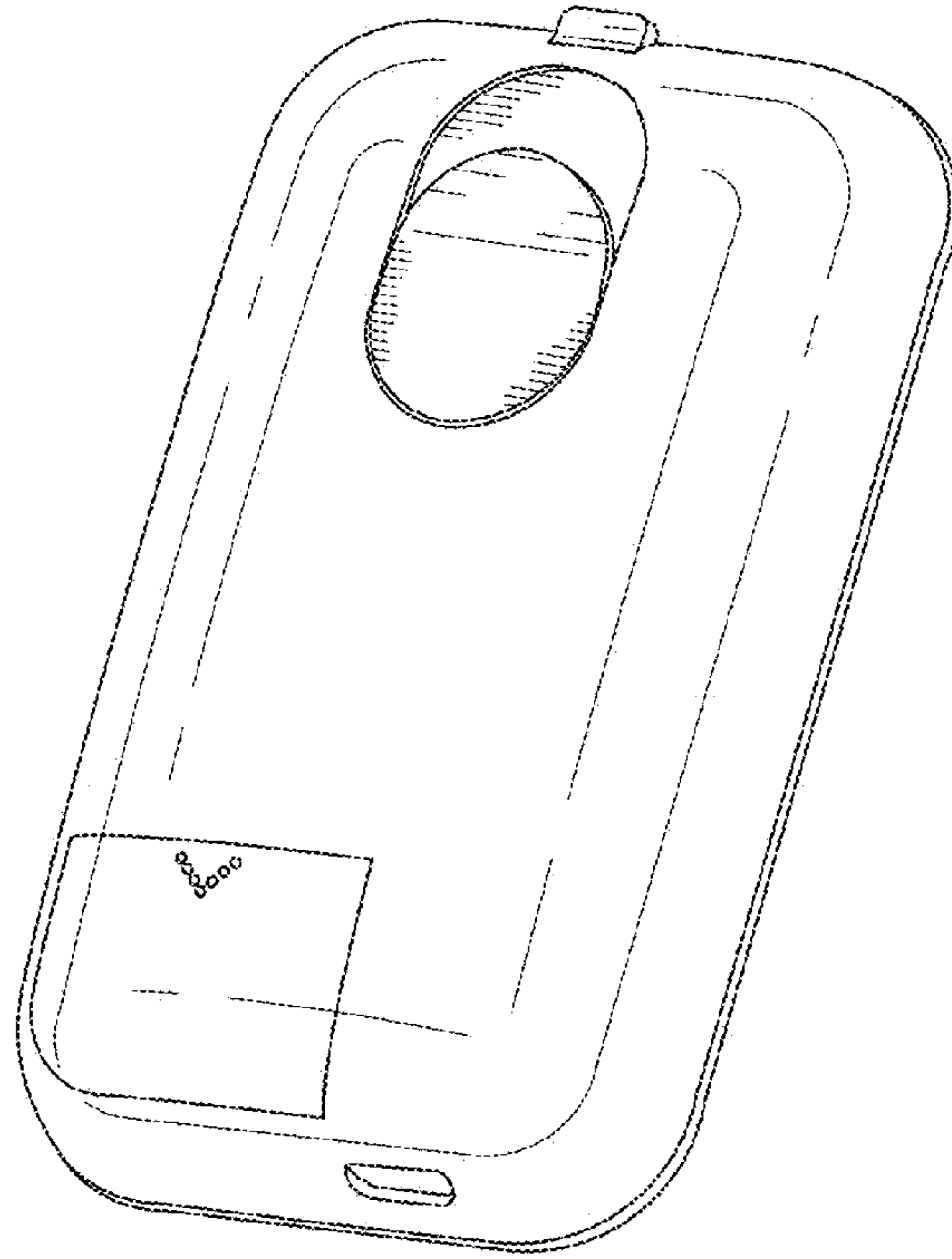

FIG. 10

