



US00D724158S

(12) **United States Design Patent**
Tsuchiya et al.

(10) **Patent No.:** **US D724,158 S**
(45) **Date of Patent:** **** Mar. 10, 2015**

(54) **TOY BUS**

(71) Applicant: **Epoch Company, Ltd.**, Tokyo (JP)

(72) Inventors: **Chihiro Tsuchiya**, Tokyo (JP); **Roger Hulks**, Hong Kong (CN)

(73) Assignee: **Epoch Company, Ltd.**, Tokyo (JP)

(**) Term: **14 Years**

(21) Appl. No.: **29/461,531**

(22) Filed: **Jul. 24, 2013**

(51) **LOC (10) Cl.** **21-01**

(52) **U.S. Cl.**
USPC **D21/559**

(58) **Field of Classification Search**
USPC D21/419, 434, 533, 548, 551, 552, 558,
D21/559; D12/84; 446/93, 95, 431, 470;
180/65.1; 296/79; D6/449
See application file for complete search history.

(56) **References Cited**

U.S. PATENT DOCUMENTS

D281,987 S * 12/1985 Catelli D21/552
D309,643 S * 7/1990 Picozza et al. D21/552
D314,594 S * 2/1991 Trossman D21/552
D347,030 S * 5/1994 Nolan D21/434

D364,893 S * 12/1995 Willard et al. D19/82
D378,905 S * 4/1997 Meister et al. D12/84
D388,744 S * 1/1998 Pfannenstiel et al. D12/84
D410,506 S * 6/1999 Lam D21/552
D602,710 S * 10/2009 Thurston D6/449

OTHER PUBLICATIONS

“School Bus”, http://en.wikidpedia.org/wiki/School_bus.

* cited by examiner

Primary Examiner — Cynthia M Chin

(74) *Attorney, Agent, or Firm* — Westerman, Hattori,
Daniels & Adrian, LLP

(57) **CLAIM**

The ornamental design for a toy bus, as shown and described.

DESCRIPTION

FIG. 1 is a left front perspective view of a toy bus showing our new design;

FIG. 2 is a right rear perspective view thereof;

FIG. 3 is a left side elevational view thereof;

FIG. 4 is a right side elevational view thereof;

FIG. 5 is a top plan view thereof;

FIG. 6 is a front elevational view thereof; and,

FIG. 7 is a rear elevational view thereof.

The broken lines illustrate portions of the toy bus that form no part of the claim.

1 Claim, 7 Drawing Sheets

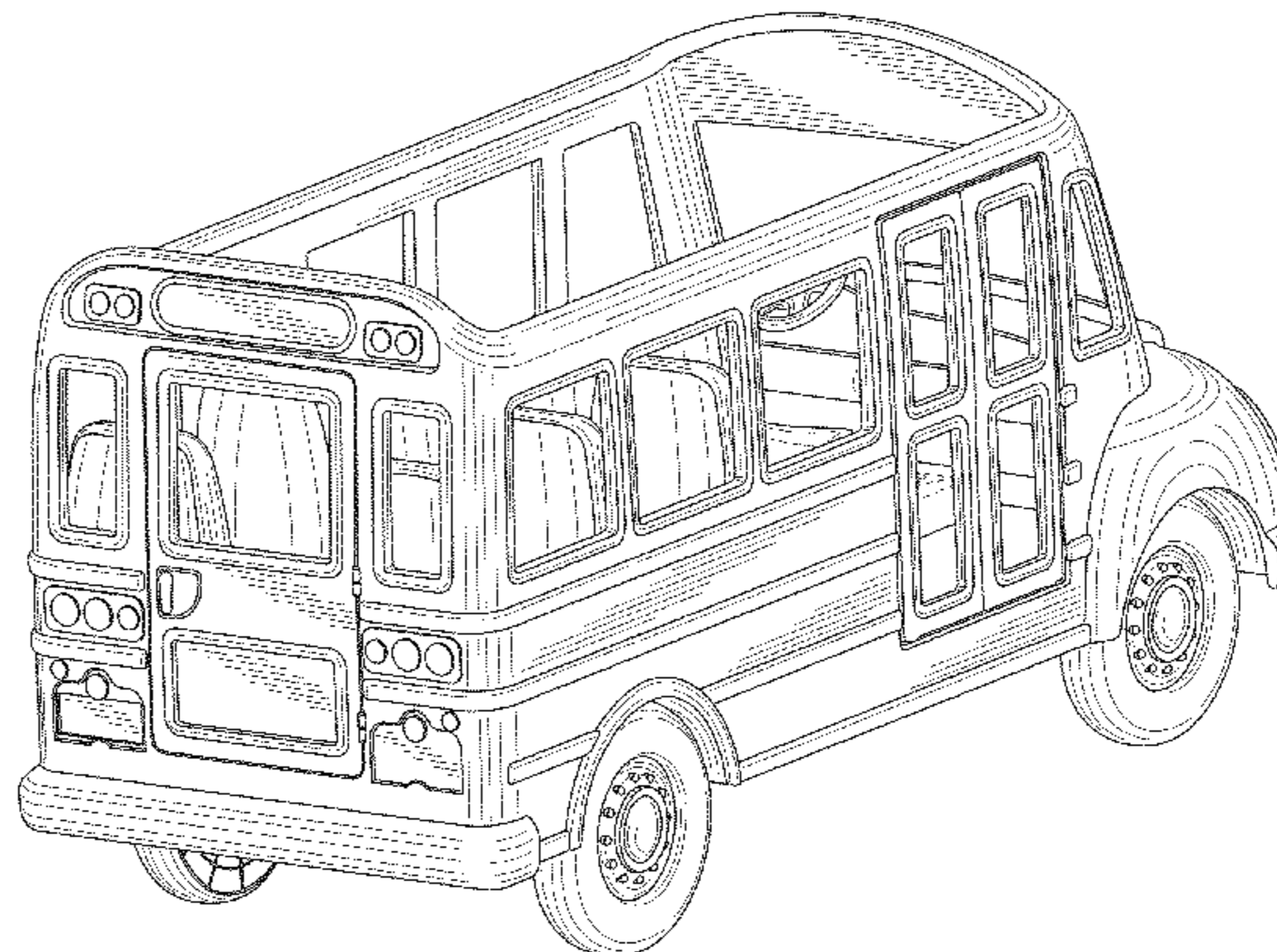
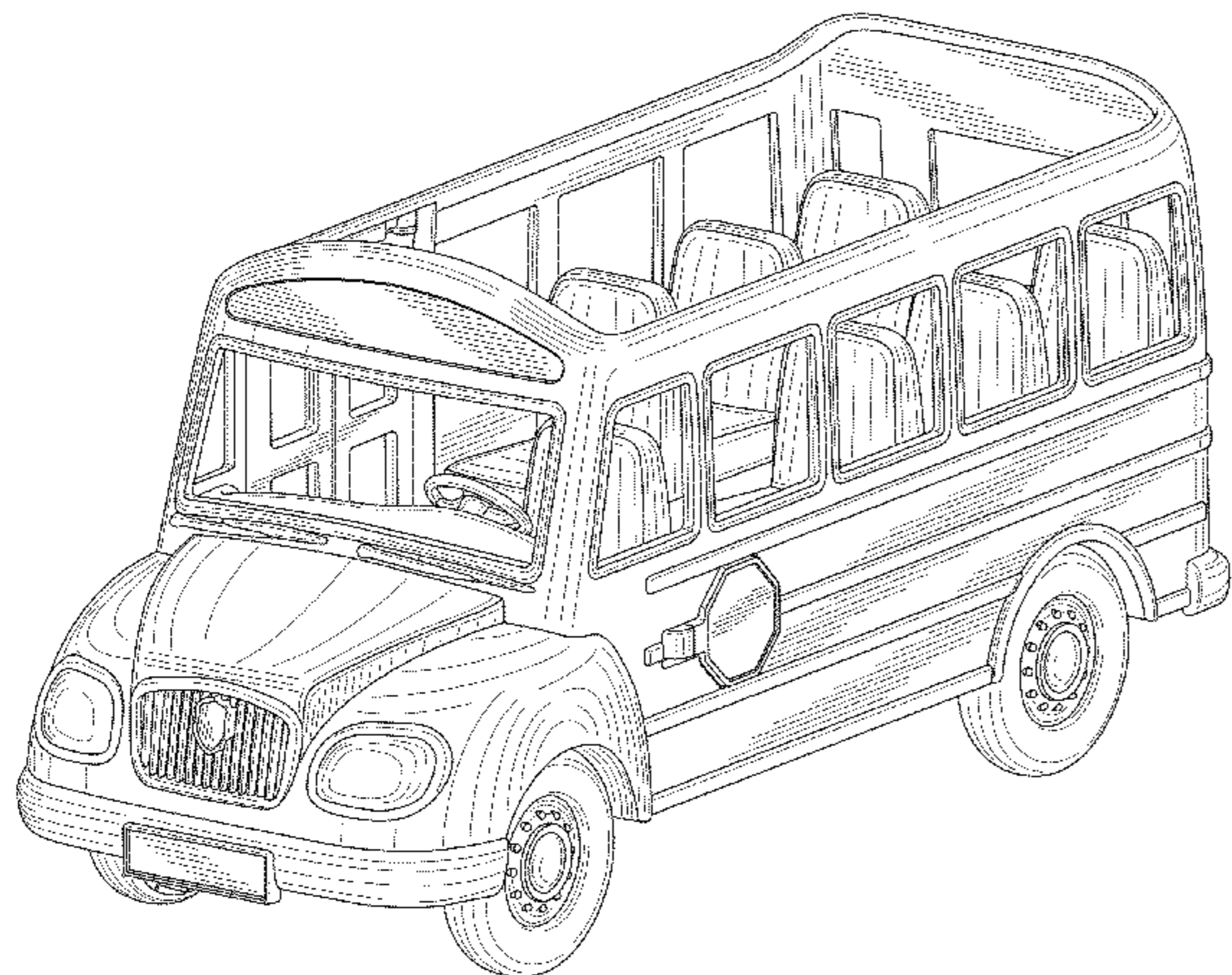

FIG. 1

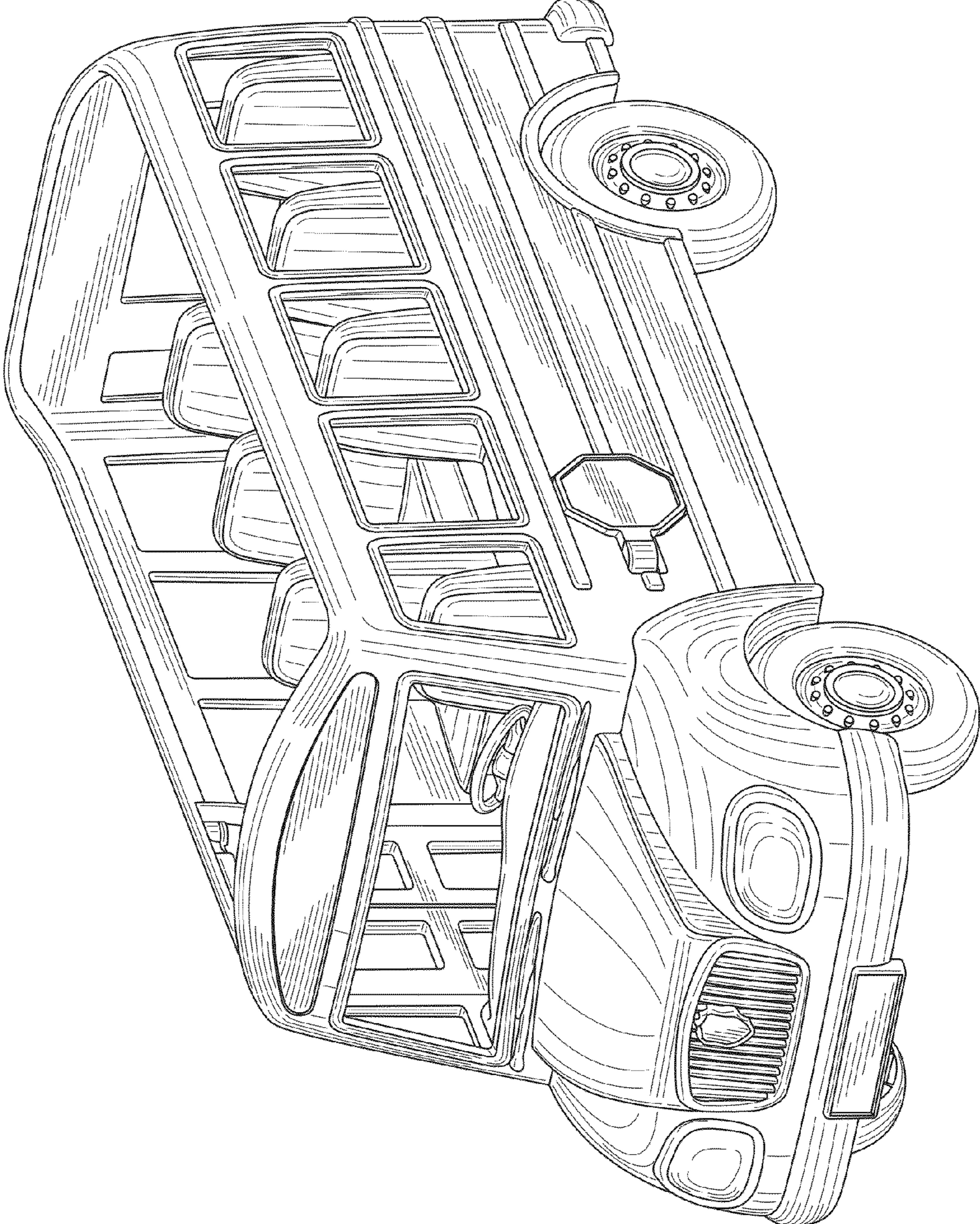

FIG. 2

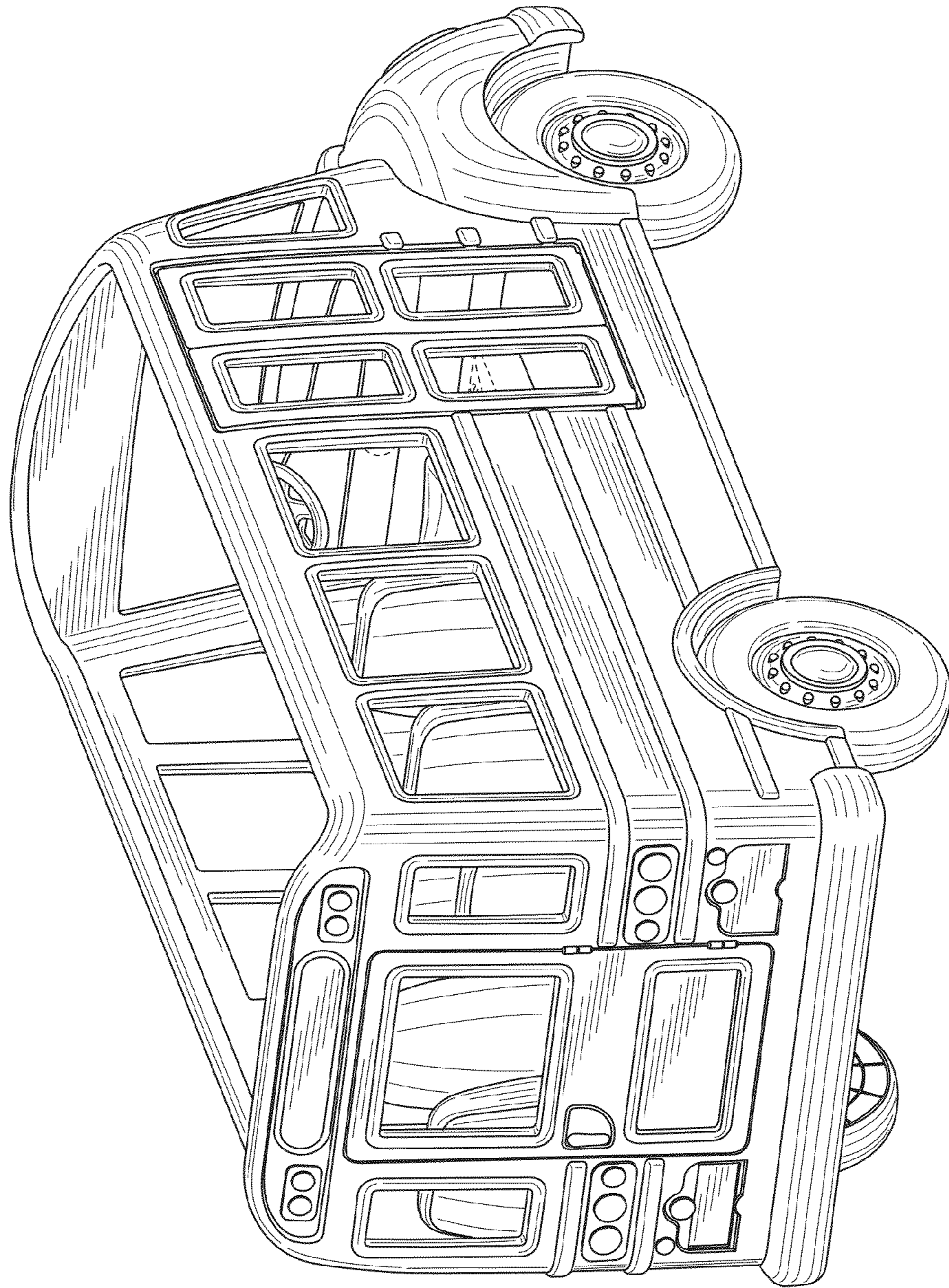

FIG. 3

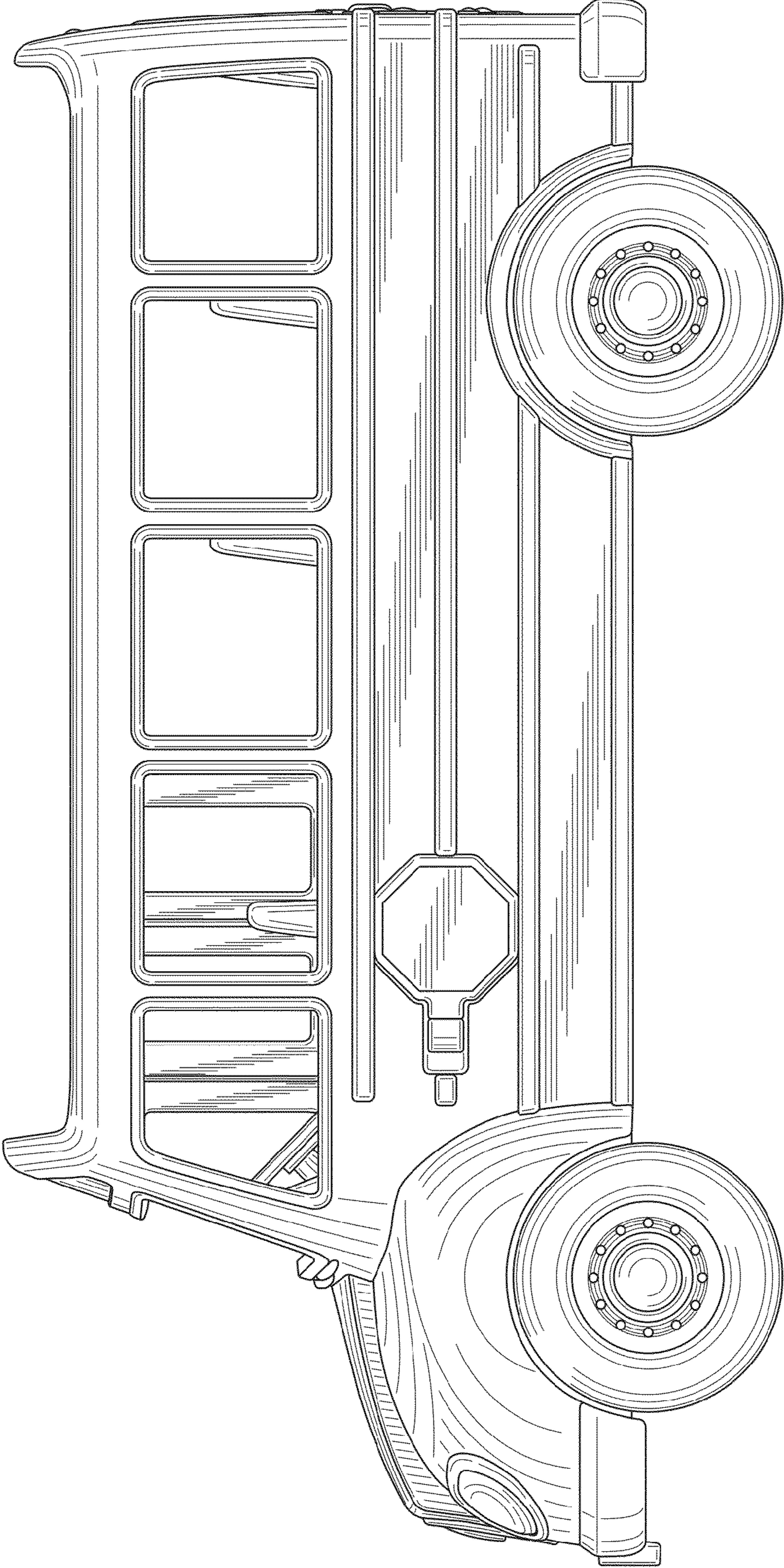

FIG. 4

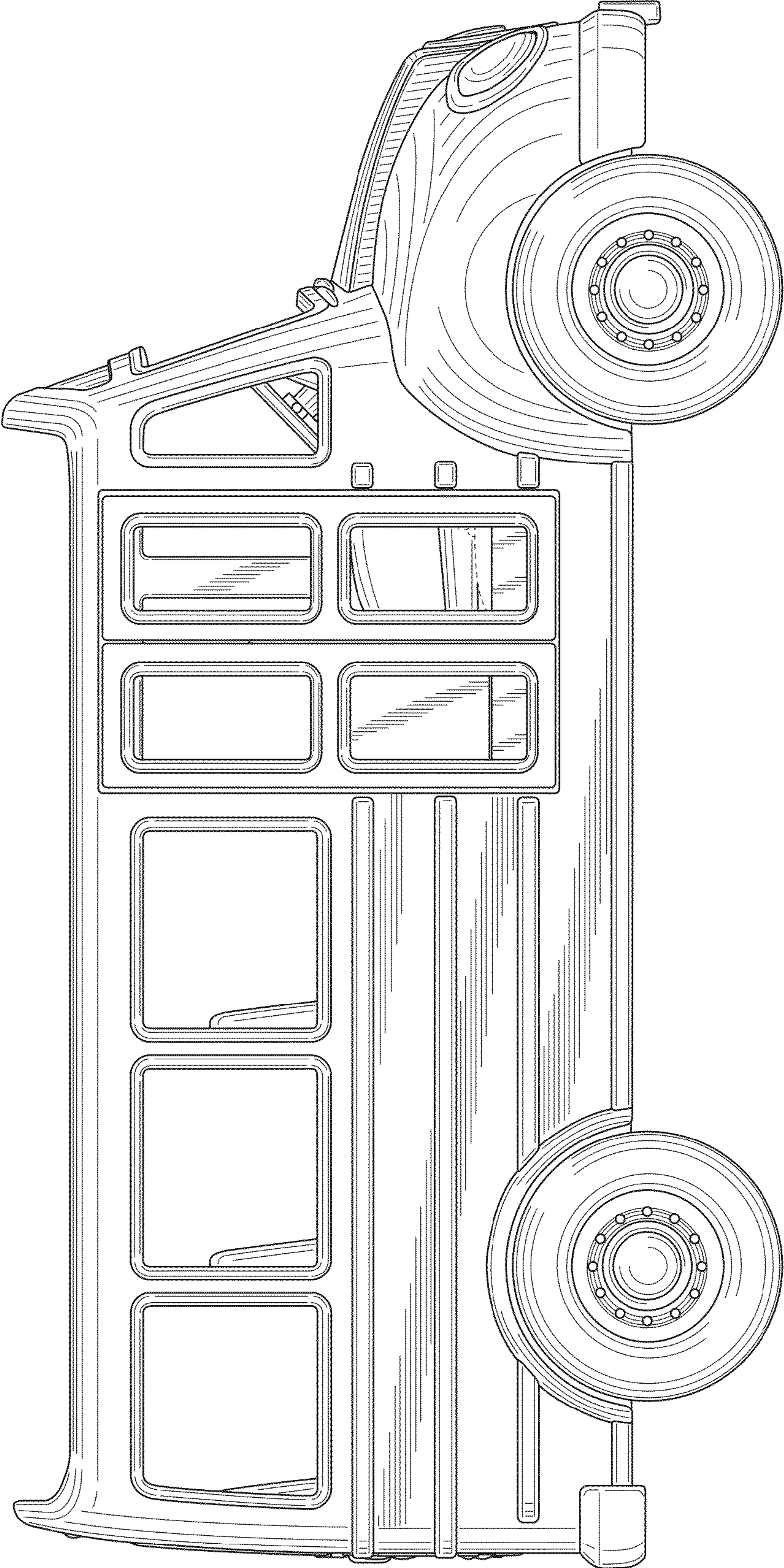

FIG. 5

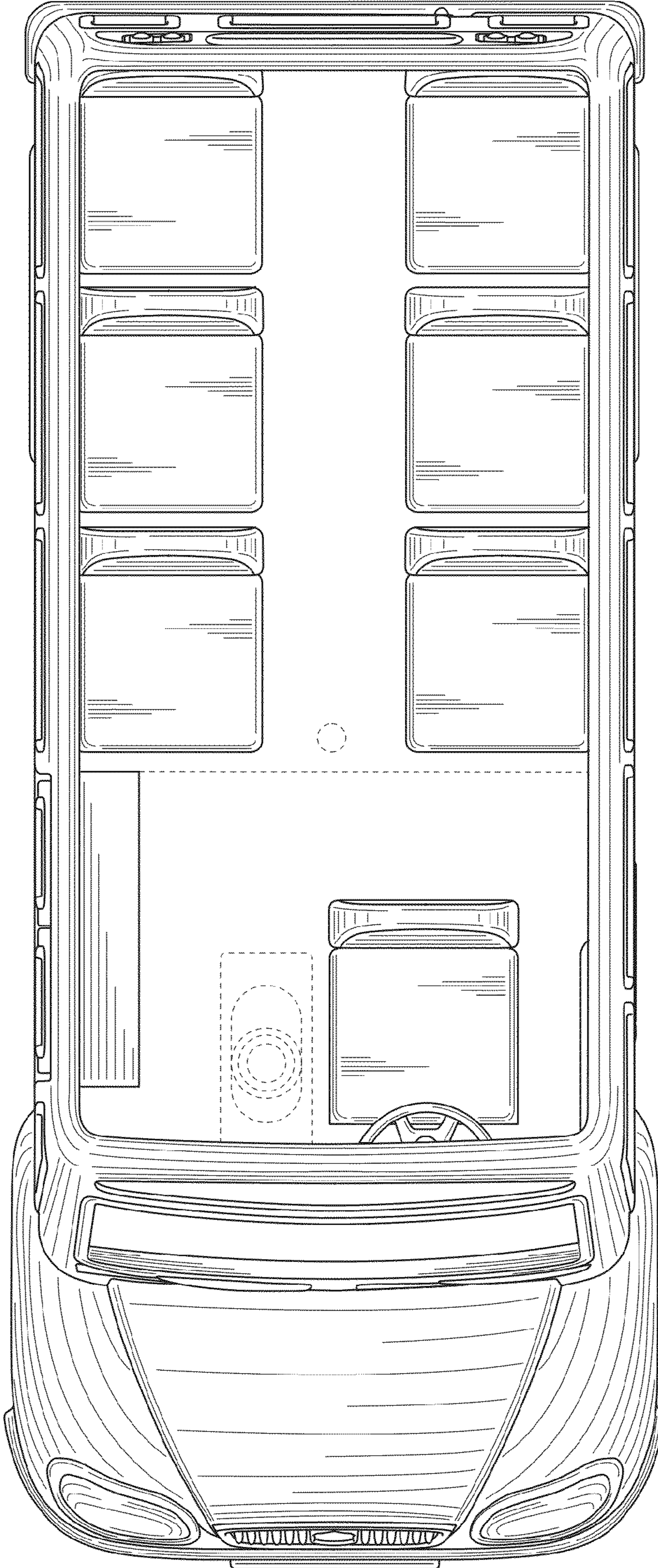

FIG. 6

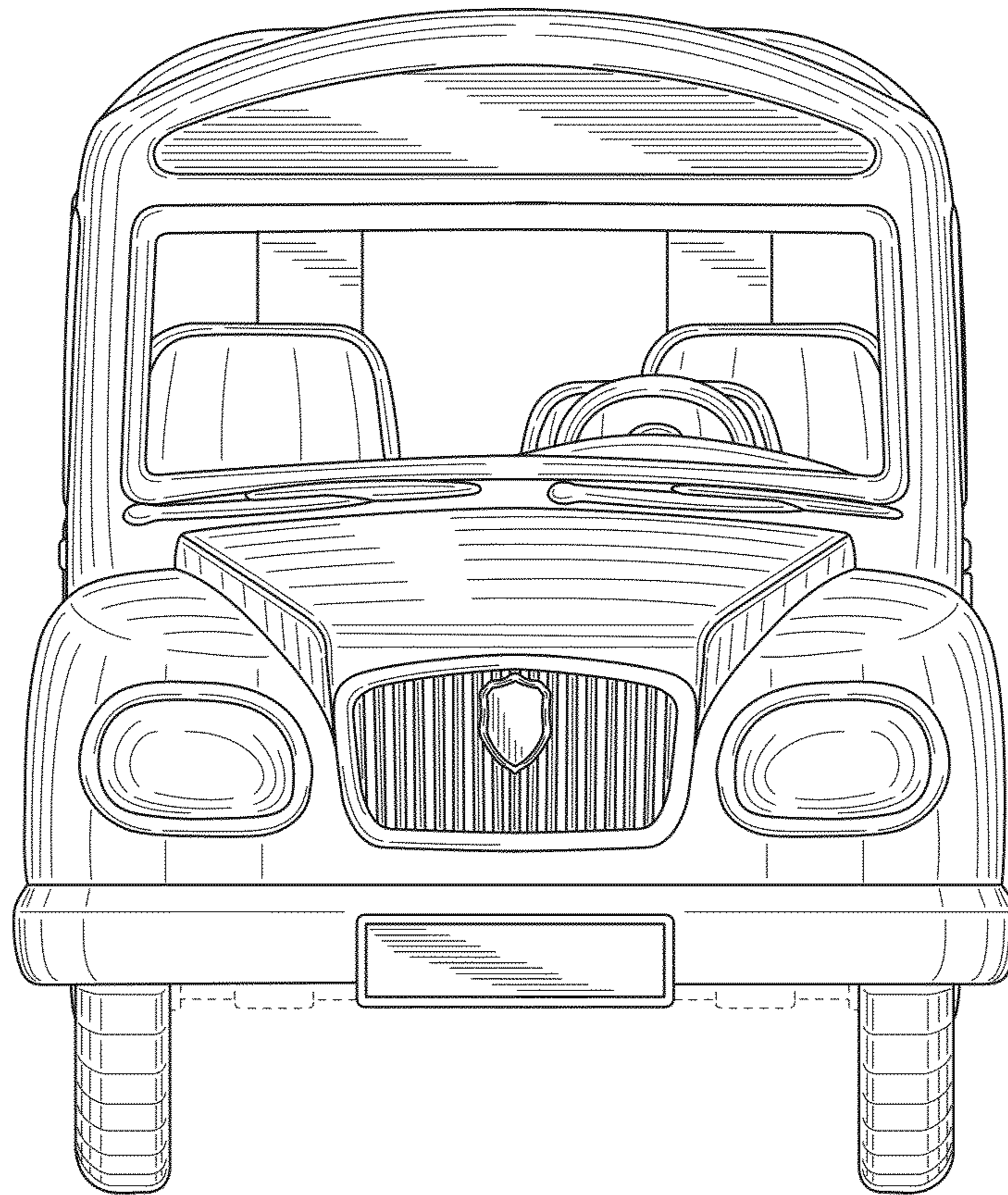

FIG. 7

