



US00D724123S

(12) **United States Design Patent**  
**Yuno et al.**

(10) **Patent No.:** **US D724,123 S**  
(45) **Date of Patent:** **\*\* \*Mar. 10, 2015**

(54) **SHEET HOLDER FOR STAMP MAKING MACHINE**

(71) Applicant: **Casio Keisanki Kabushiki Kaisha**,  
Shibuya-ku, Tokyo (JP)

(72) Inventors: **Hiroataka Yuno**, Fussa (JP); **Yoshimasa Yokoyama**, Hachioji (JP)

(73) Assignee: **Casio Keisanki Kabushiki Kaisha**,  
Tokyo (JP)

(\*) Notice: This patent is subject to a terminal disclaimer.

(\*\*) Term: **14 Years**

(21) Appl. No.: **29/468,422**

(22) Filed: **Sep. 30, 2013**

(51) **LOC (10) Cl.** ..... **15-09**

(52) **U.S. Cl.**  
USPC ..... **D15/128**; D15/138

(58) **Field of Classification Search**  
USPC ..... D15/128, 138; D18/50, 54, 55, 56;  
101/27, 31; 400/21-30, 144.2,  
400/691-693

See application file for complete search history.

(56) **References Cited**

**U.S. PATENT DOCUMENTS**

D203,626	S	*	2/1966	Donald	.....	D15/128
D208,584	S	*	9/1967	Susskind	.....	D15/128
D231,862	S	*	6/1974	Gramling	.....	D15/128
3,874,262	A	*	4/1975	Cailloux	.....	83/549
D274,335	S	*	6/1984	Jenkins	.....	D15/128
D277,864	S	*	3/1985	Hoffman et al.	.....	D15/128
D309,472	S	*	7/1990	Nishida	.....	D18/35.1
4,956,786	A	*	9/1990	Drummond et al.	.....	700/160

D354,303	S	*	1/1995	Noonan et al.	.....	D18/15
5,839,367	A	*	11/1998	Hashimoto	.....	101/316
D420,019	S	*	2/2000	Tachibana et al.	.....	D15/128
D420,020	S	*	2/2000	Morita	.....	D15/128
D658,688	S	*	5/2012	Chiang	.....	D15/128
8,539,683	B2	*	9/2013	Kuno	.....	33/18.1
2009/0095046	A1	*	4/2009	Bytow	.....	72/466.7
2011/0132164	A1	*	6/2011	Barandiaran Echeguia	....	83/145

**OTHER PUBLICATIONS**

U.S. Appl. No. 29/468,151, filed Sep. 26, 2013; First Named Inventor: Hiroataka Yuno; Title: "Sheet Holder for Stamp Making Machine".

U.S. Appl. No. 29/468,156, filed Sep. 26, 2013; First Named Inventor: Hiroataka Yuno; Title: "Sheet Holder for Stamp Making Machine".

(Continued)

*Primary Examiner* — Patricia Palasik

(74) *Attorney, Agent, or Firm* — Holtz, Holtz, Goodman & Chick PC

(57) **CLAIM**

The ornamental design for a sheet holder for stamp making machine, as shown and described.

**DESCRIPTION**

FIG. 1 is a front, right side, top perspective view of a sheet holder for stamp making machine showing our new design; FIG. 2 is a front elevational view thereof; FIG. 3 is a rear elevational view thereof; FIG. 4 is a left side view thereof; FIG. 5 is a right side view thereof; FIG. 6 is a top plan view thereof; FIG. 7 is a bottom plan view thereof; and, FIG. 8 is a reference view thereof showing a using state. The portions in broken lines are shown for illustrative purposes only and form no part of the claimed design.

**1 Claim, 7 Drawing Sheets**

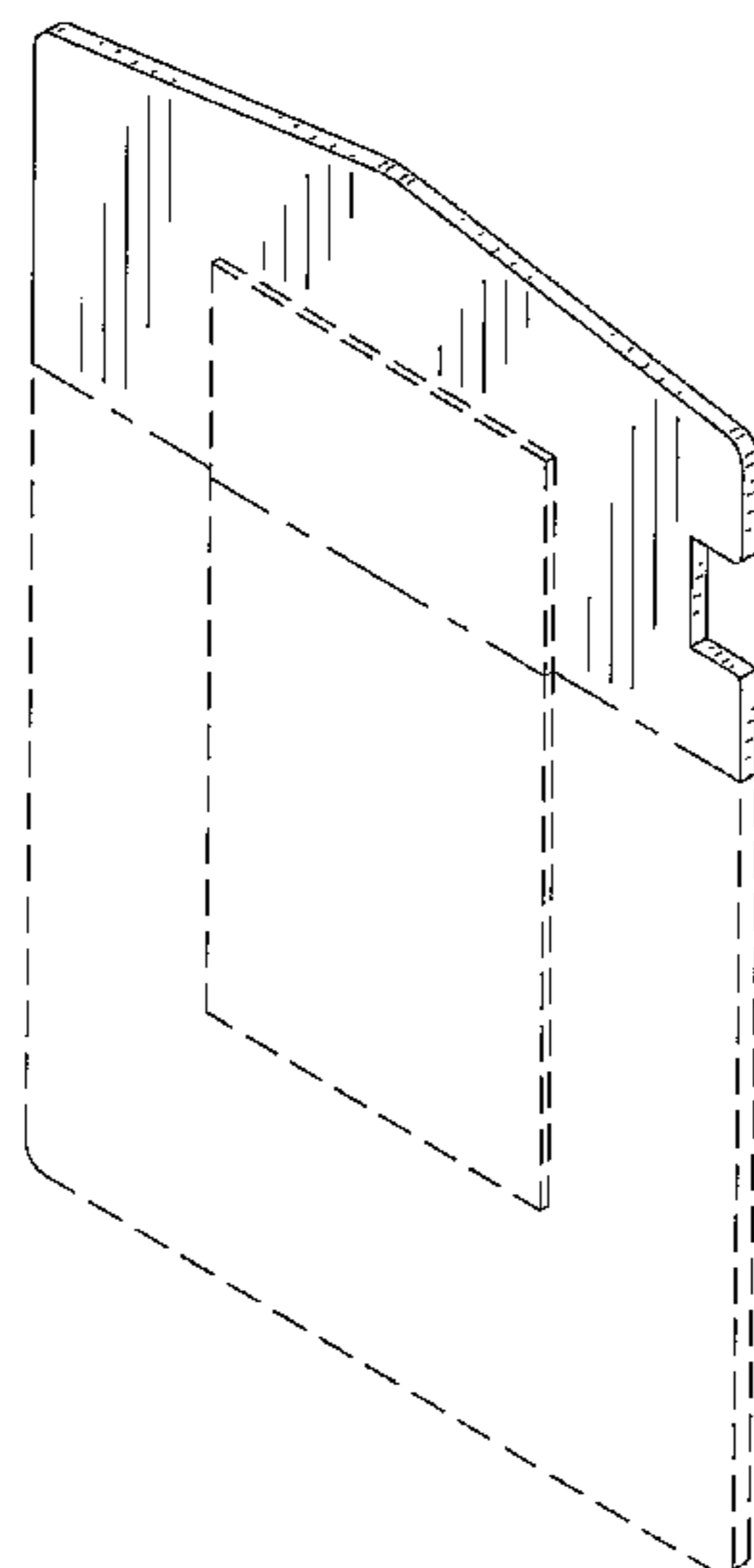

(56)

**References Cited**

OTHER PUBLICATIONS

U.S. Appl. No. 29/468,417, filed Sep. 30, 2013; First Named Inventor: Hirotaka Yuno; Title: "Sheet Holder for Stamp Making Machine".

U.S. Appl. No. 29/468,425, filed Sep. 30, 2013; First Named Inventor: Hirotaka Yuno; Title: "Sheet Holder for Stamp Making Machine".

\* cited by examiner

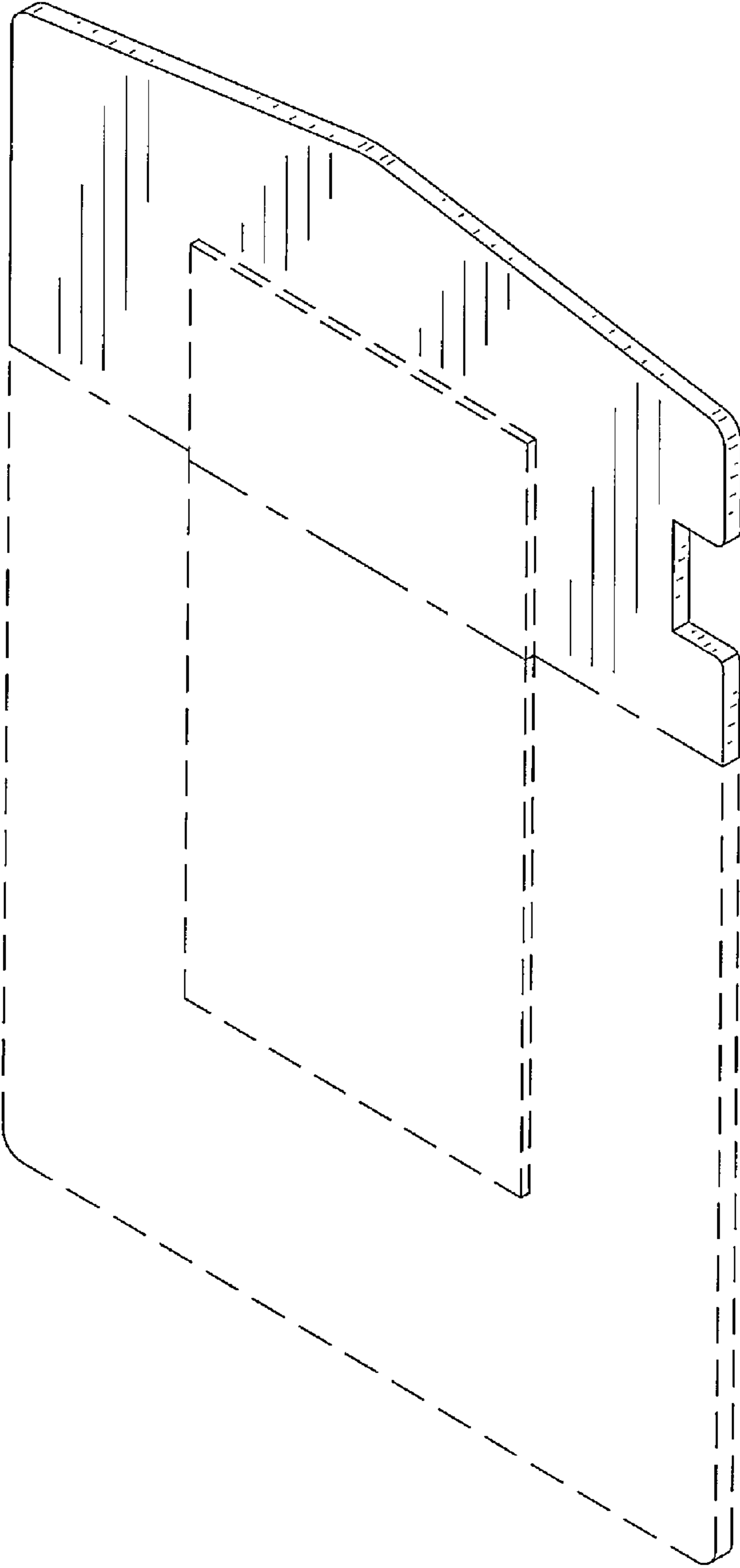

FIG. 1

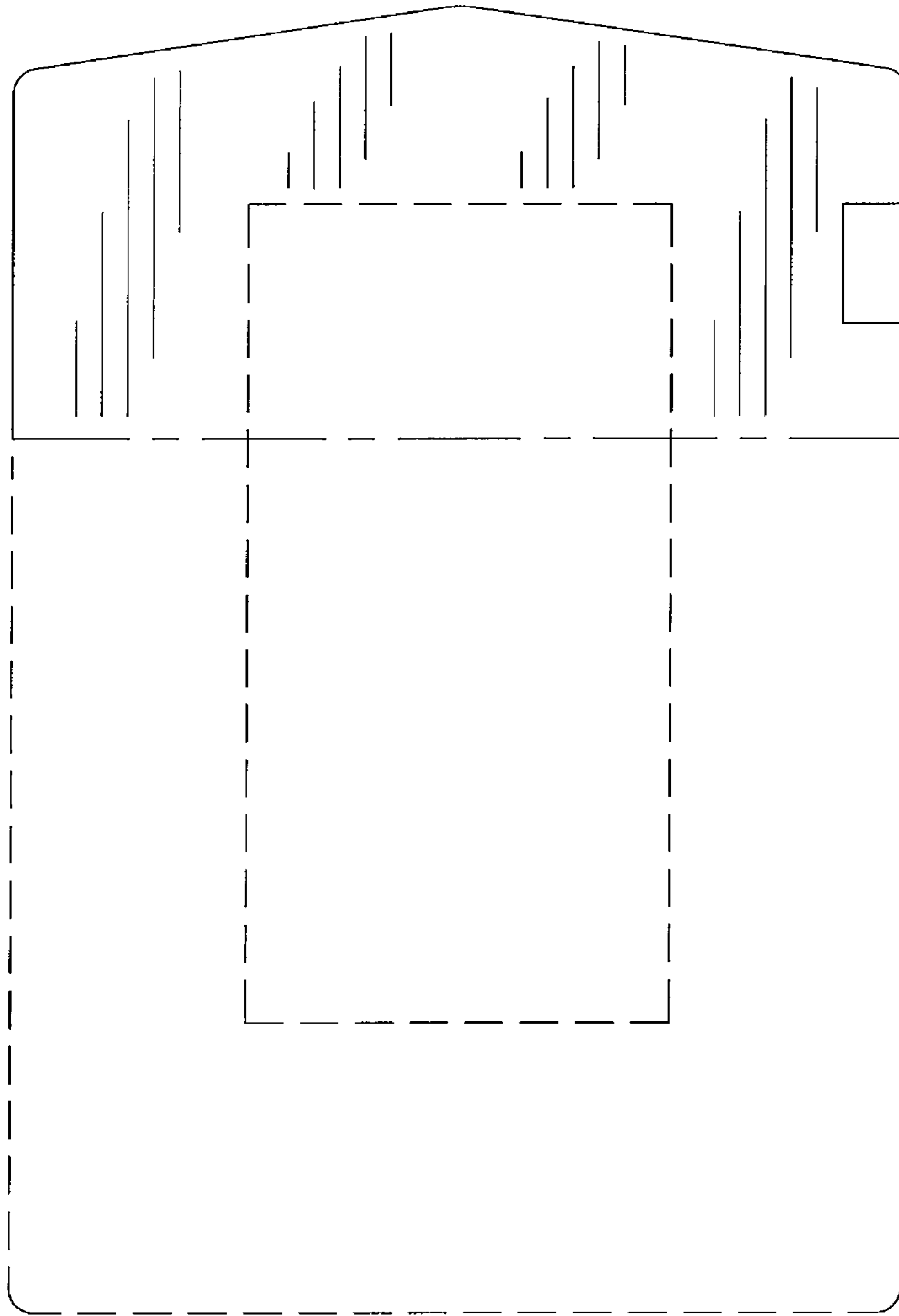

FIG. 2

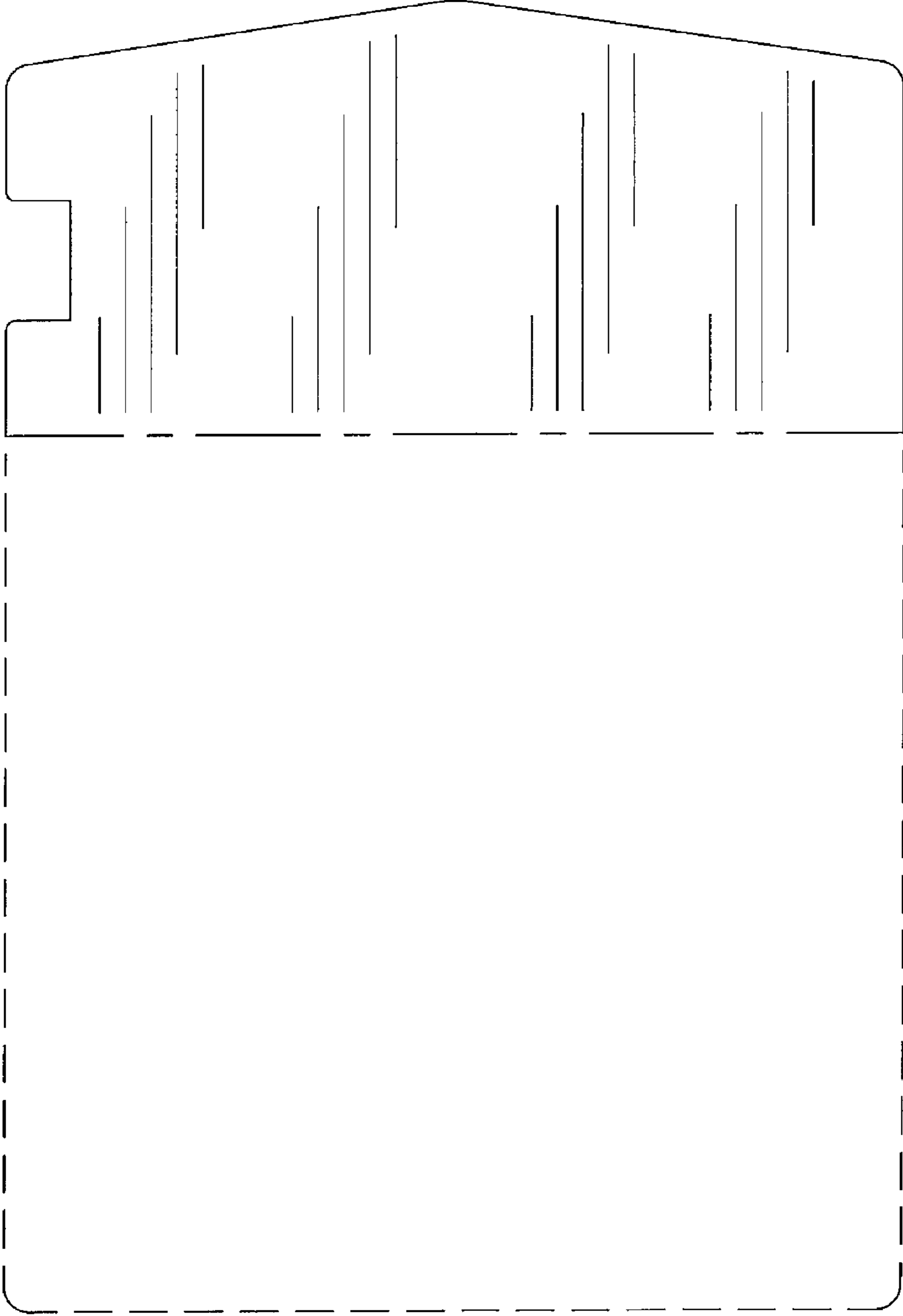

FIG. 3

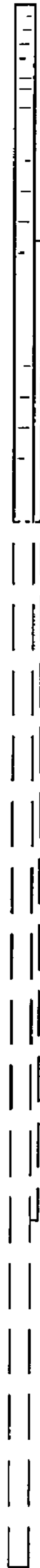

FIG. 4

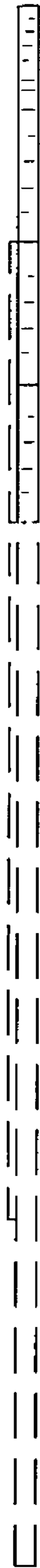

FIG. 5

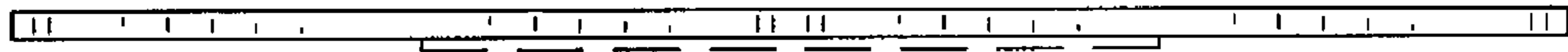

FIG. 6

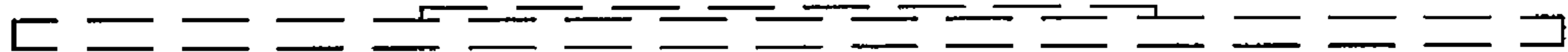

FIG. 7



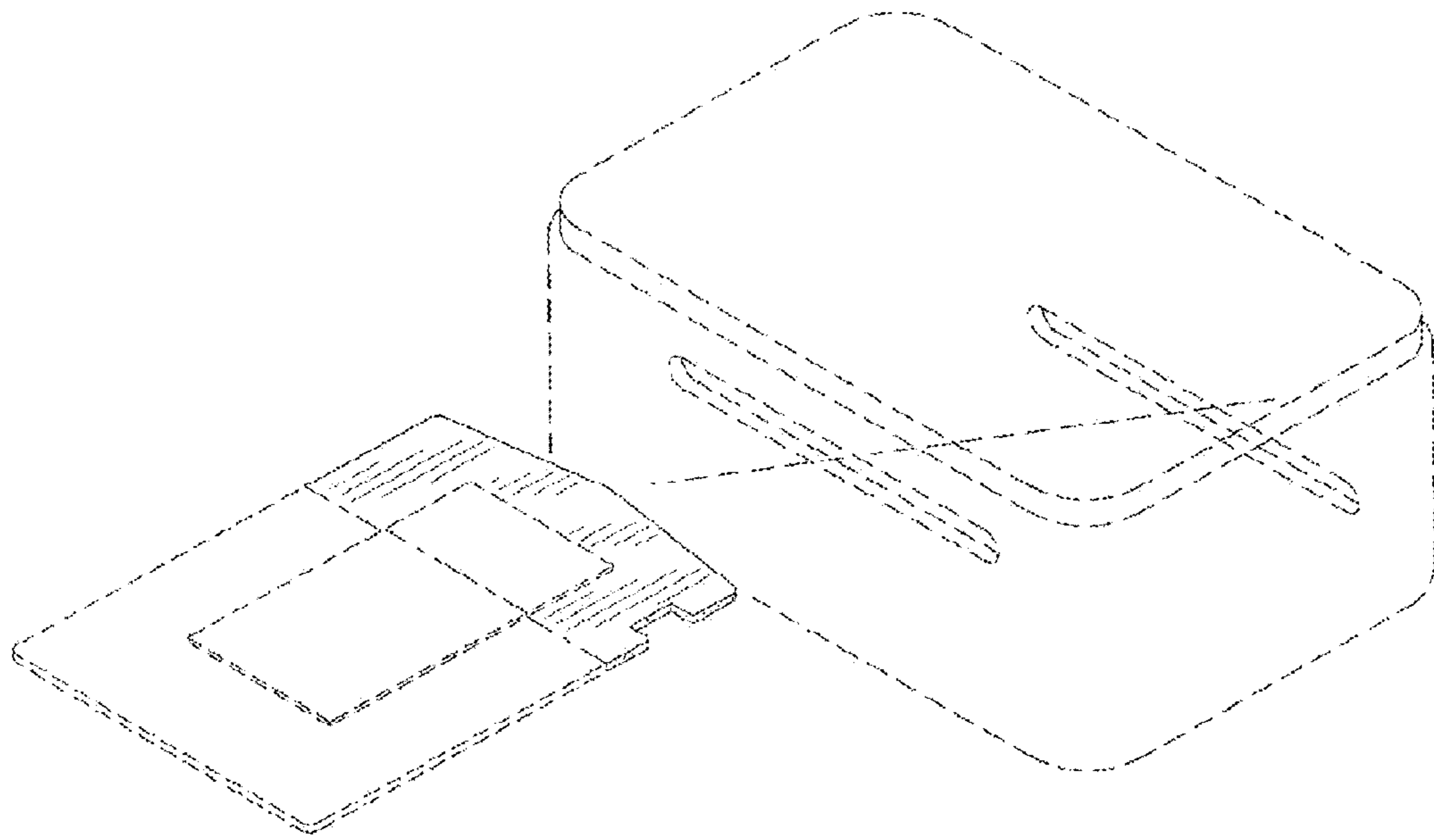

FIG. 8