



US00D724120S

(12) **United States Design Patent**  
**Ryu et al.**

(10) **Patent No.:** **US D724,120 S**  
(45) **Date of Patent:** **\*\* Mar. 10, 2015**

(54) **DOOR FOR REFRIGERATOR**

(56) **References Cited**

(71) Applicant: **Samsung Electronics Co., Ltd.**,  
Suwon-si (KR)  
(72) Inventors: **Jin-Ie Ryu**, Seoul (KR); **Sang-Min**  
**Hyun**, Seoul (KR); **Ji-Hyun Moon**,  
Gwangmyeong-si (KR); **Yang-Jic Lee**,  
Gwacheon-si (KR)

U.S. PATENT DOCUMENTS

D175,011	S	*	6/1955	Boldt	.....	D15/88
2,776,866	A	*	1/1957	Harbison	.....	312/311
D484,152	S	*	12/2003	Becke	.....	D15/91
D513,270	S	*	12/2005	Seok et al.	.....	D15/89
D572,732	S	*	7/2008	Baacke et al.	.....	D15/91
D661,325	S	*	6/2012	Yang et al.	.....	D15/89
D702,742	S	*	4/2014	Hwan et al.	.....	D15/91

\* cited by examiner

(73) Assignee: **Samsung Electronics Co., Ltd.**,  
Suwon-si (KR)

*Primary Examiner* — Stella Reid  
*Assistant Examiner* — Khawaja Anwar  
(74) *Attorney, Agent, or Firm* — NSIP Law

(\*\*) Term: **14 Years**

(57) **CLAIM**  
The ornamental design for a door for refrigerator, as shown and described.

(21) Appl. No.: **29/466,458**

**DESCRIPTION**

(22) Filed: **Sep. 9, 2013**

FIG. 1 is a front perspective view of a door for refrigerator showing our new design;  
FIG. 2 is a front view thereof;  
FIG. 3 is a rear view thereof;  
FIG. 4 is a left-side view thereof;  
FIG. 5 is a right-side view thereof;  
FIG. 6 is a top view thereof;  
FIG. 7 is a bottom view thereof; and,  
FIG. 8 is another front perspective view thereof.  
The broken lines shown in the drawings show unclaimed environment only and form no part of the claimed design; the additional broken lines shown in FIG. 8 of the drawings show unclaimed subject matter only and also form no part of the claimed design.

(30) **Foreign Application Priority Data**

Mar. 9, 2013 (KR) ..... 30-2013-0012052

(51) **LOC (10) Cl.** ..... **15-07**

(52) **U.S. Cl.**  
USPC ..... **D15/91**

(58) **Field of Classification Search**  
USPC ..... D15/79-91; 62/373, 3.1, 3.6; 312/236,  
312/116, 119, 138.1, 139.2, 400-408

See application file for complete search history.

**1 Claim, 6 Drawing Sheets**

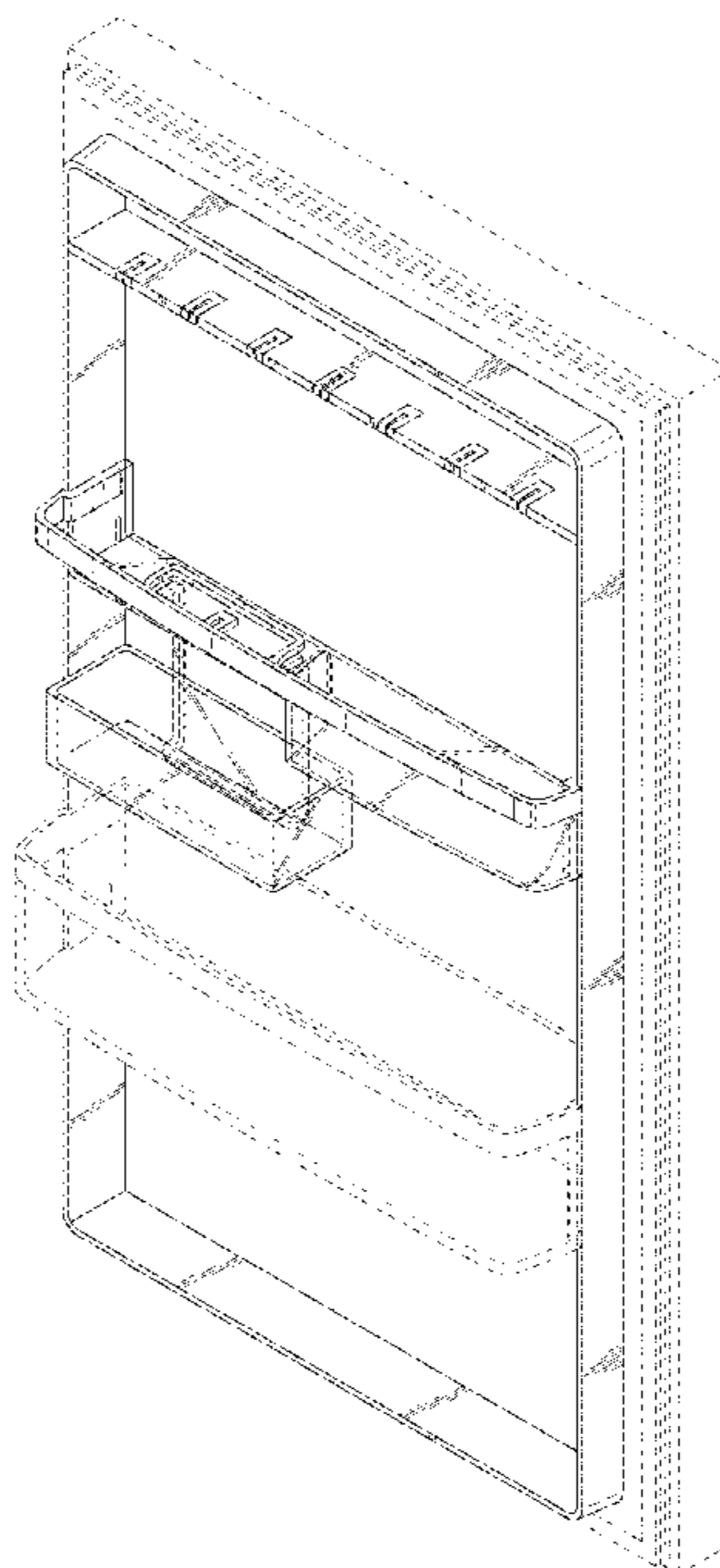

FIG. 1

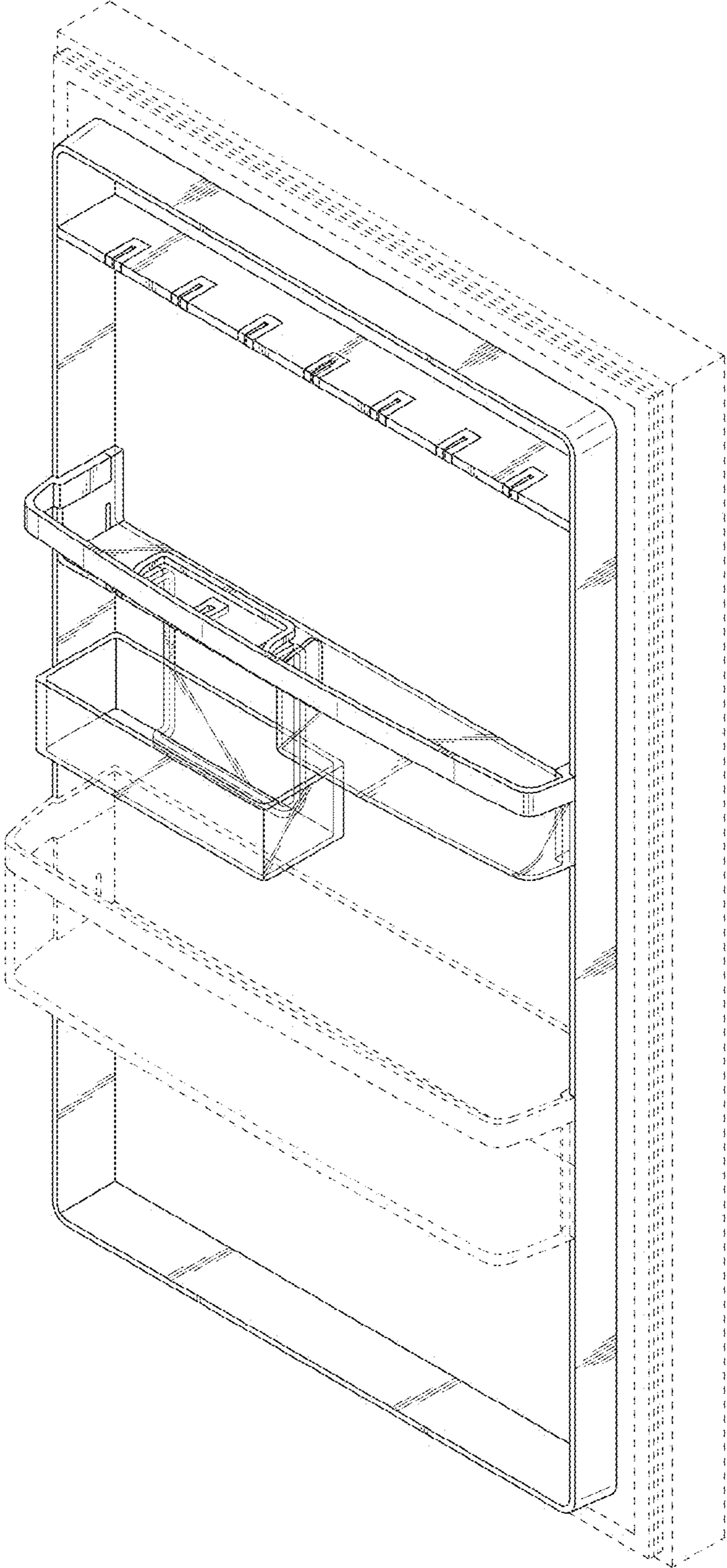

FIG.2

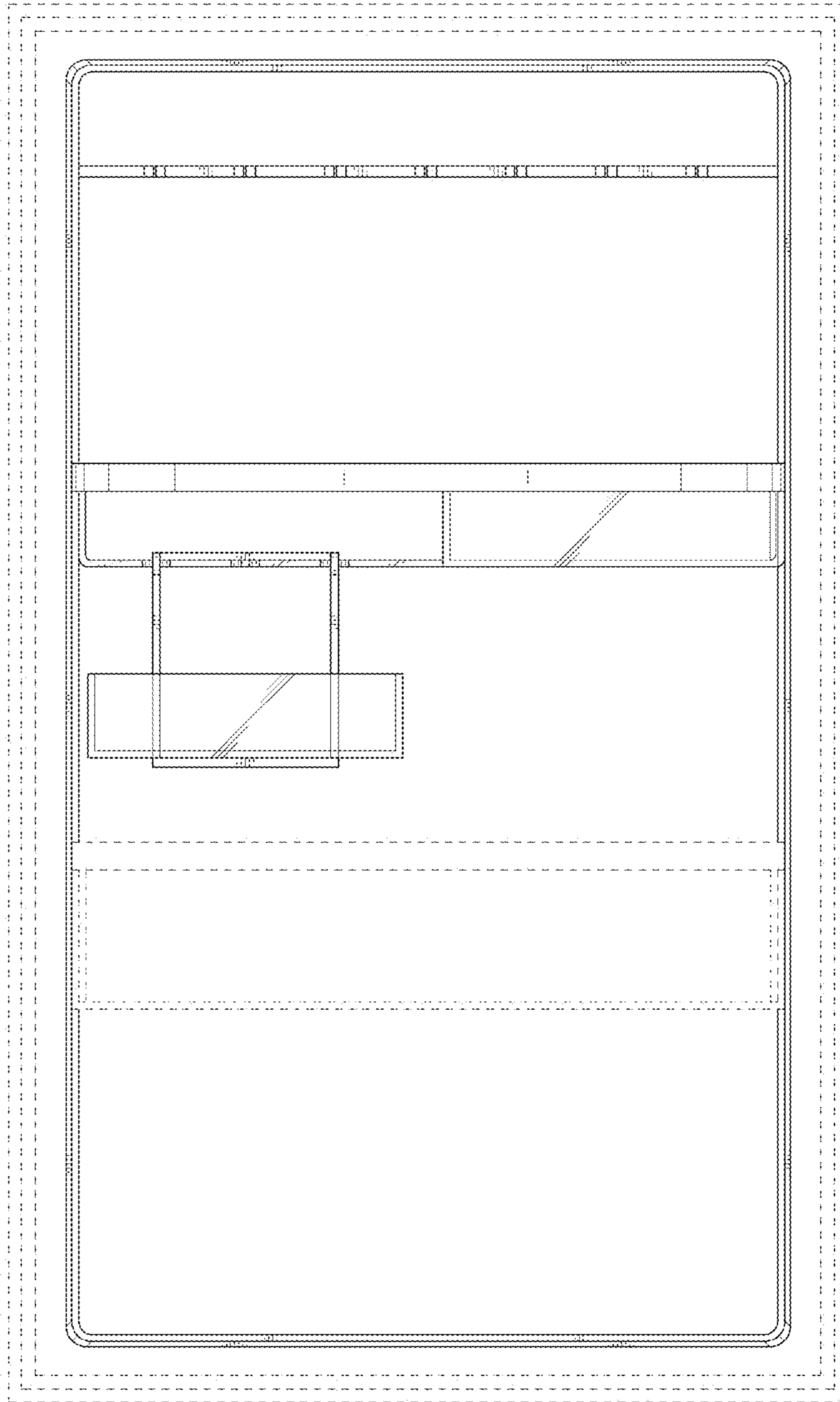

FIG.3



FIG.4

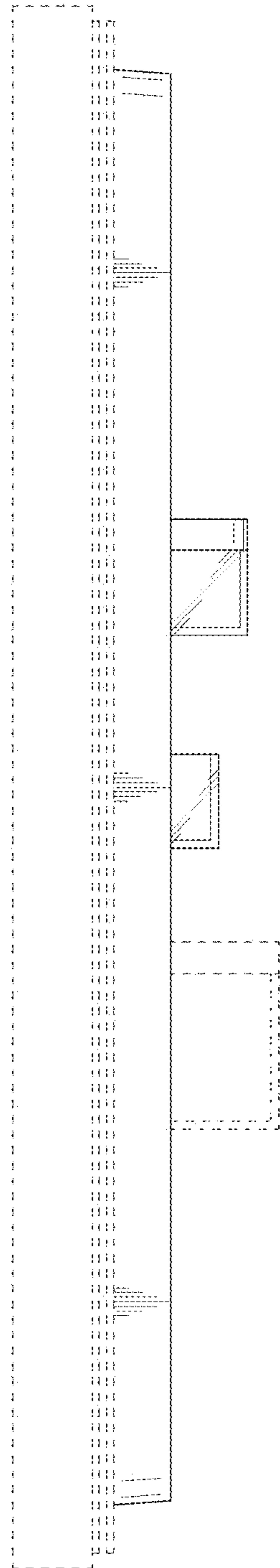

FIG.5

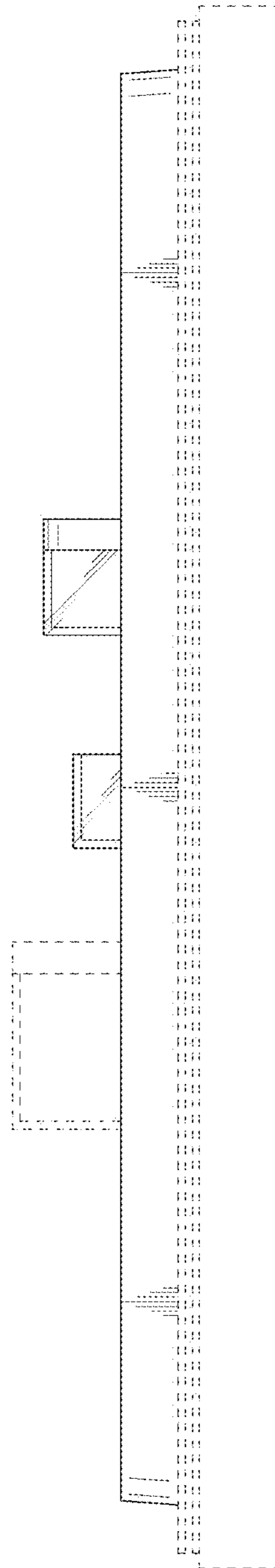

FIG.6

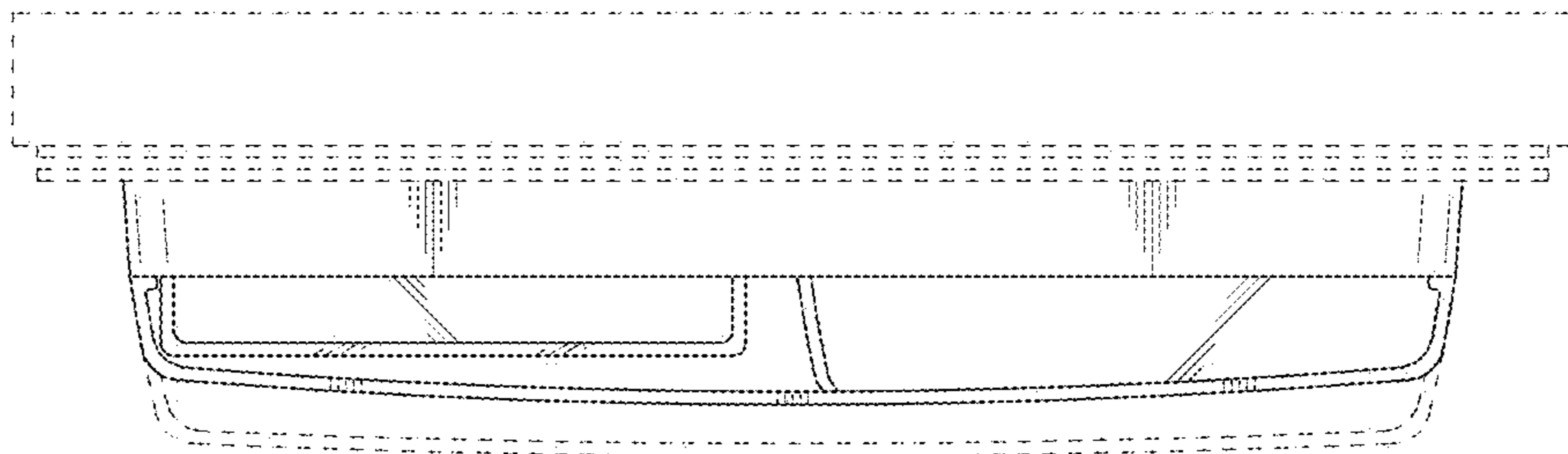

FIG.7

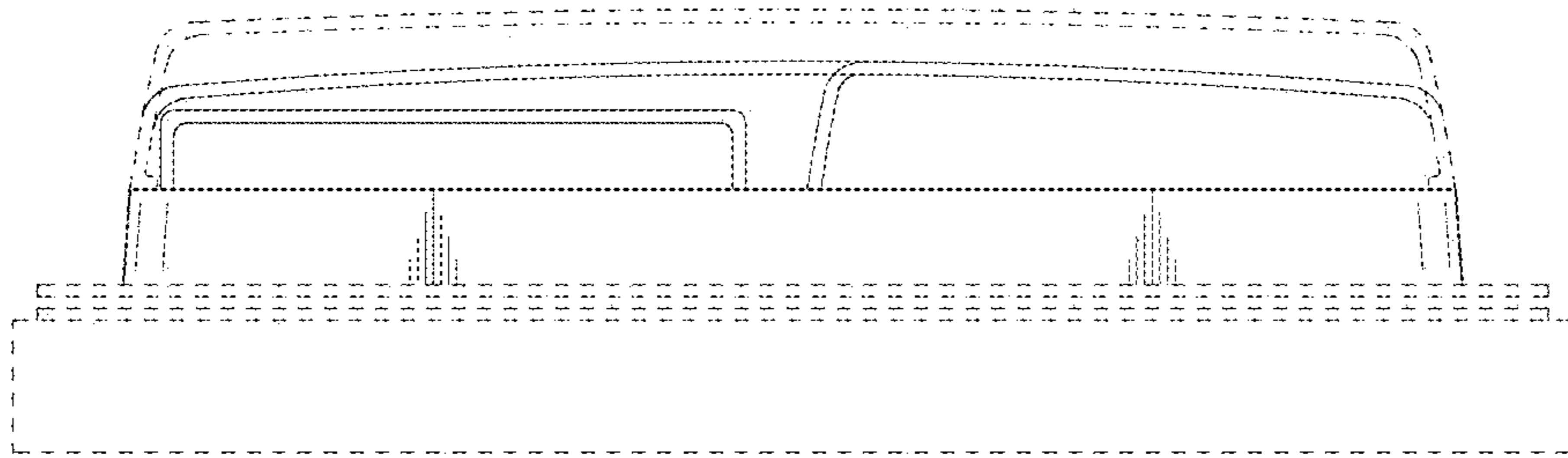

FIG.8

