



US00D724069S

(12) **United States Design Patent**  
**Kyum**

(10) **Patent No.:** **US D724,069 S**  
(45) **Date of Patent:** **\*\* Mar. 10, 2015**

(54) **CASE FOR ELECTRONIC DEVICE**

(71) Applicant: **Kim Mun Kyum**, Xiamen (CN)

(72) Inventor: **Kim Mun Kyum**, Xiamen (CN)

(\*\*) Term: **14 Years**

(21) Appl. No.: **29/442,101**

(22) Filed: **Dec. 5, 2012**

(51) **LOC (10) Cl.** ..... **14-03**

(52) **U.S. Cl.**  
USPC ..... **D14/250**

(58) **Field of Classification Search**  
CPC G06F 1/1628; A45C 2013/025; A45C 13/02;  
A45C 11/00  
USPC ..... D14/138 AD, 138 C, 138 G, 203.7, 230,  
D14/238.1, 240, 247, 248, 250, 253, 341,  
D14/345, 346, 439, 440, 447, 496;  
D13/103, 107, 119; D3/201, 218, 269,  
D3/273, 303; 206/320; 455/456.1, 575.1,  
455/575.4, 575.8

See application file for complete search history.

(56) **References Cited**

**U.S. PATENT DOCUMENTS**

D503,532 S \* 4/2005 Andre et al. .... D3/218  
D594,224 S \* 6/2009 Leung et al. .... D3/218  
D594,225 S \* 6/2009 Leung et al. .... D3/218  
D594,226 S \* 6/2009 Hofer et al. .... D3/218

D606,739 S \* 12/2009 Fahrendorff et al. .... D3/218  
D629,193 S \* 12/2010 Liu ..... D3/218  
D644,216 S \* 8/2011 Richardson et al. .... D14/250  
D659,383 S \* 5/2012 Phillips et al. .... D3/218  
D659,691 S \* 5/2012 Kim et al. .... D14/250  
D679,699 S \* 4/2013 Piedra et al. .... D14/250  
D682,540 S \* 5/2013 Phillips et al. .... D3/218  
D682,815 S \* 5/2013 Chang ..... D14/250

\* cited by examiner

*Primary Examiner* — Barbara Fox

*Assistant Examiner* — Chelsea Sealey

(74) *Attorney, Agent, or Firm* — Kiran Malhotra

(57) **CLAIM**

The ornamental design for a case for electronic device, as shown and described.

**DESCRIPTION**

FIG. 1 is a front isometric view of a case for electronic device, showing my new design;  
FIG. 2 is a rear isometric view thereof;  
FIG. 3 is a front view thereof;  
FIG. 4 is a rear view thereof;  
FIG. 5 is a left view thereof;  
FIG. 6 is a right view thereof;  
FIG. 7 is a top view thereof;  
FIG. 8 is a bottom view thereof; and,  
FIG. 9 is another rear isometric view thereof.  
The broken lines indicate portions of the case for electronic device that form no part of the claimed design.

**1 Claim, 7 Drawing Sheets**

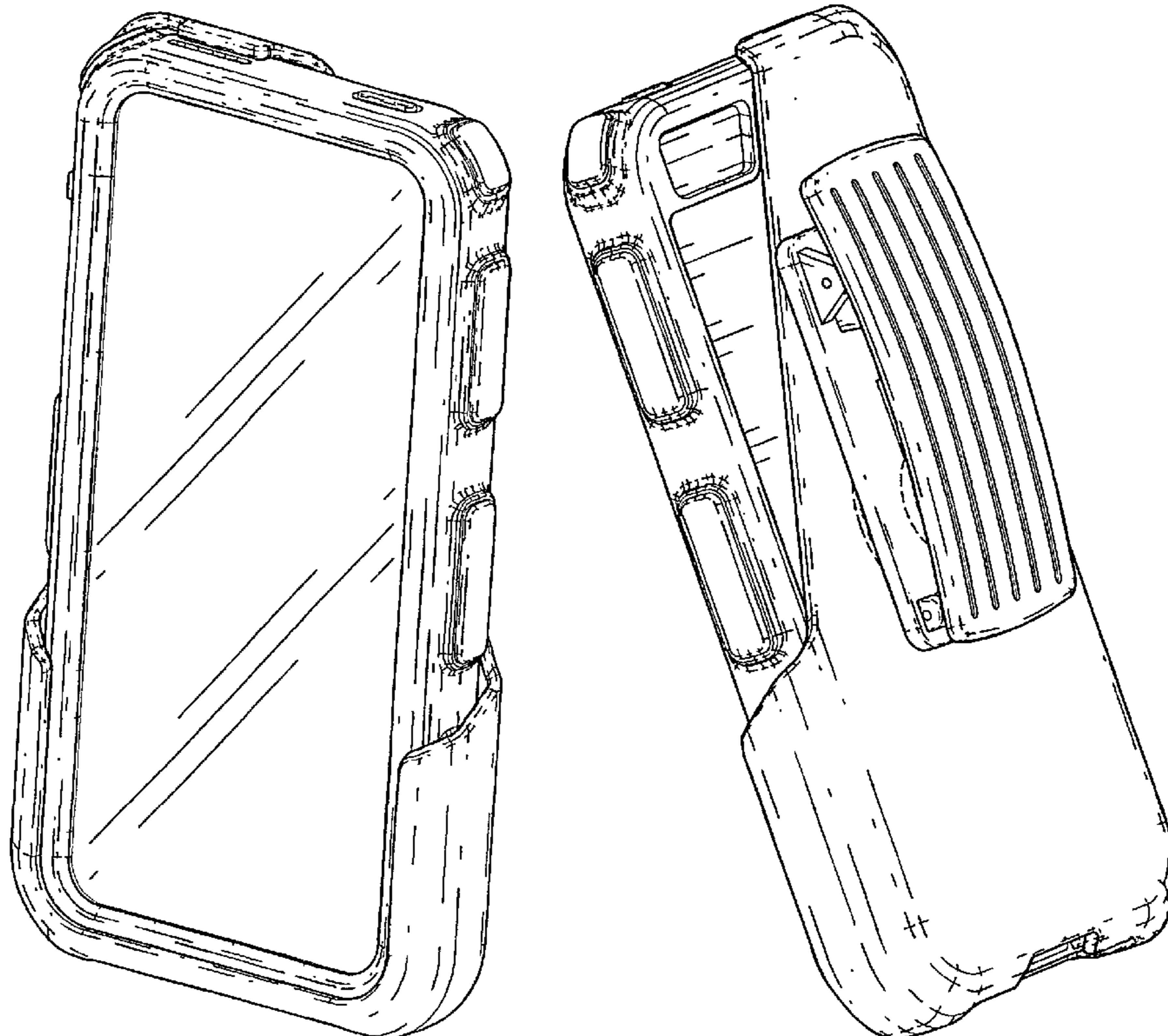

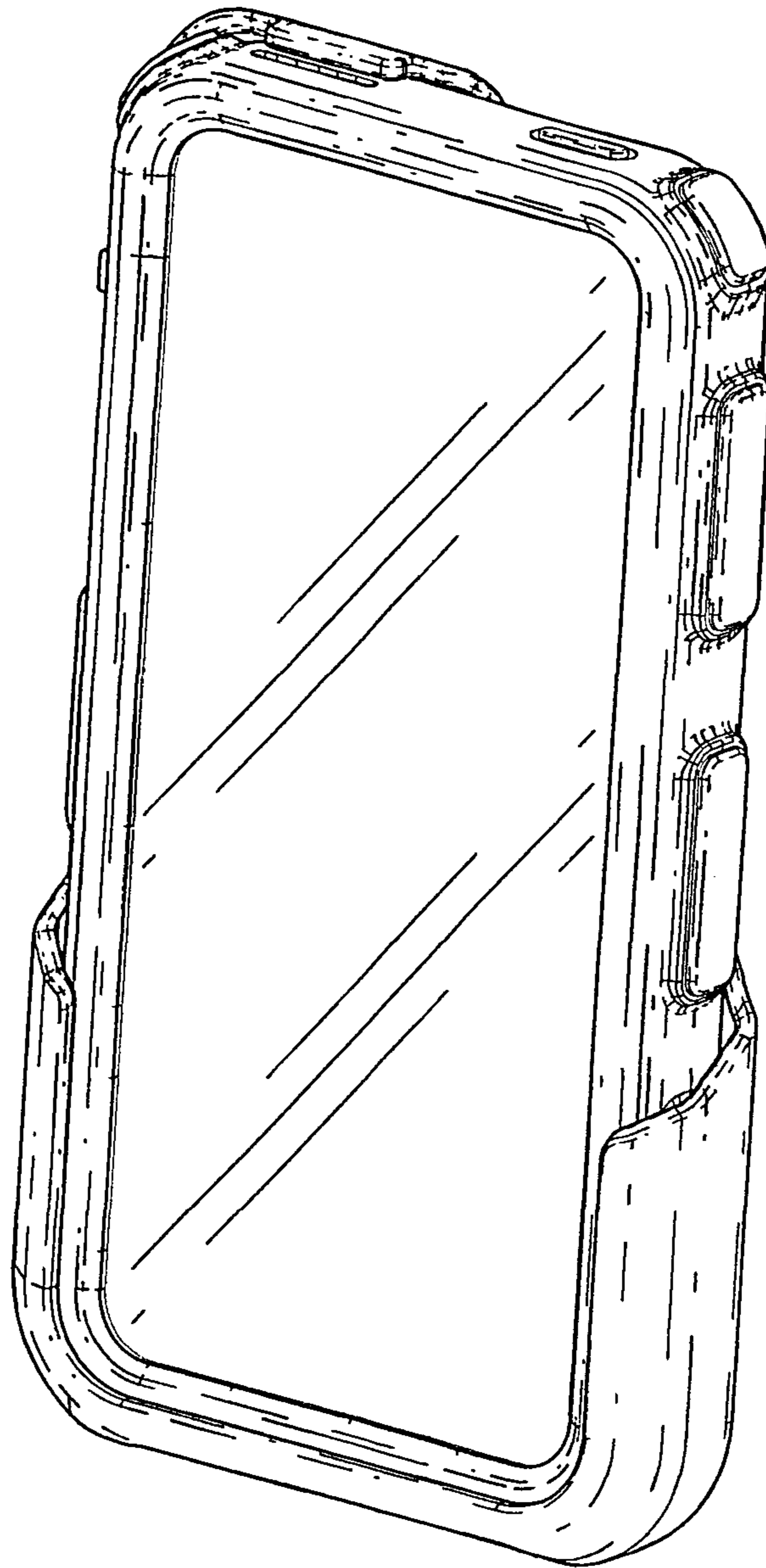

FIG. 1

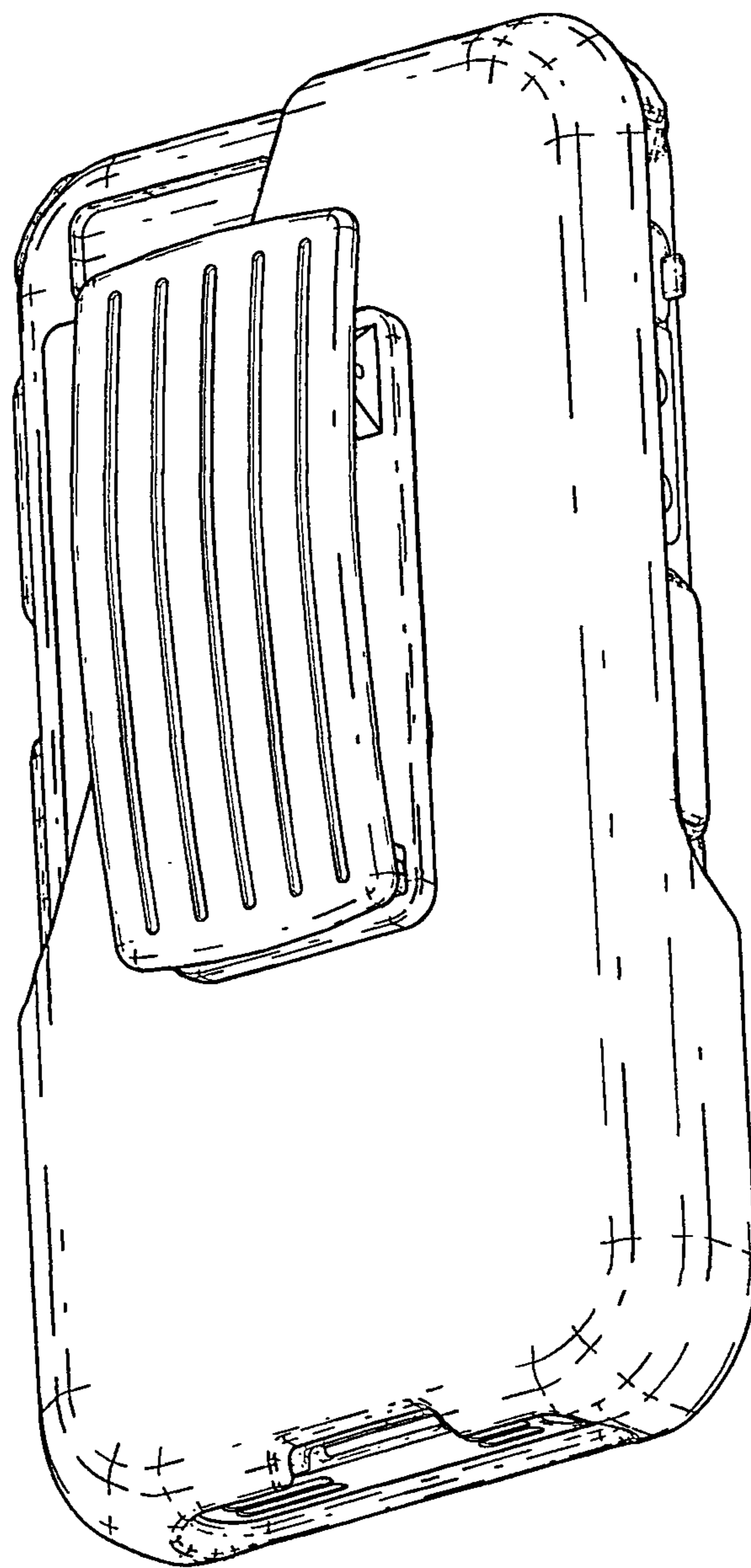

FIG. 2

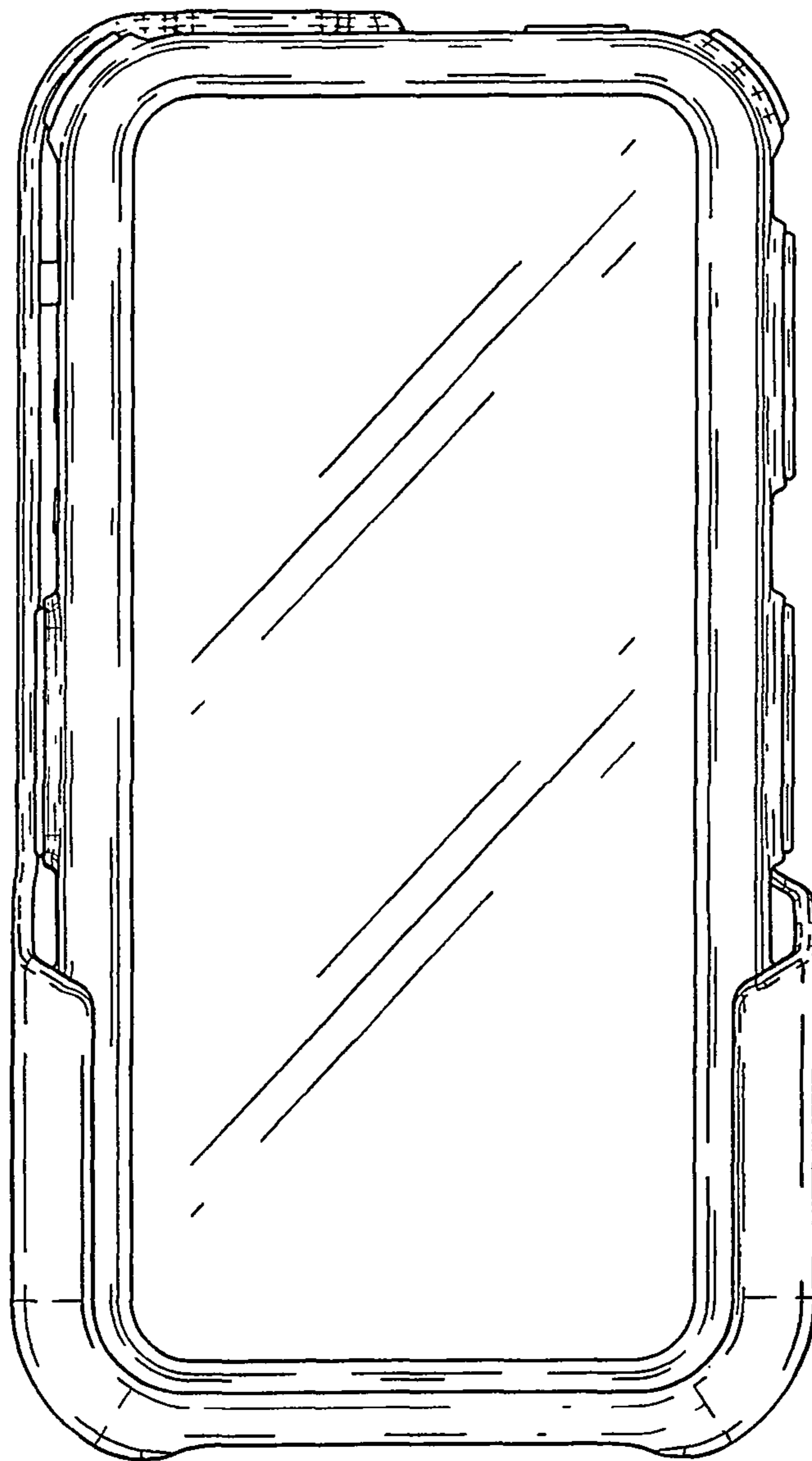

FIG. 3

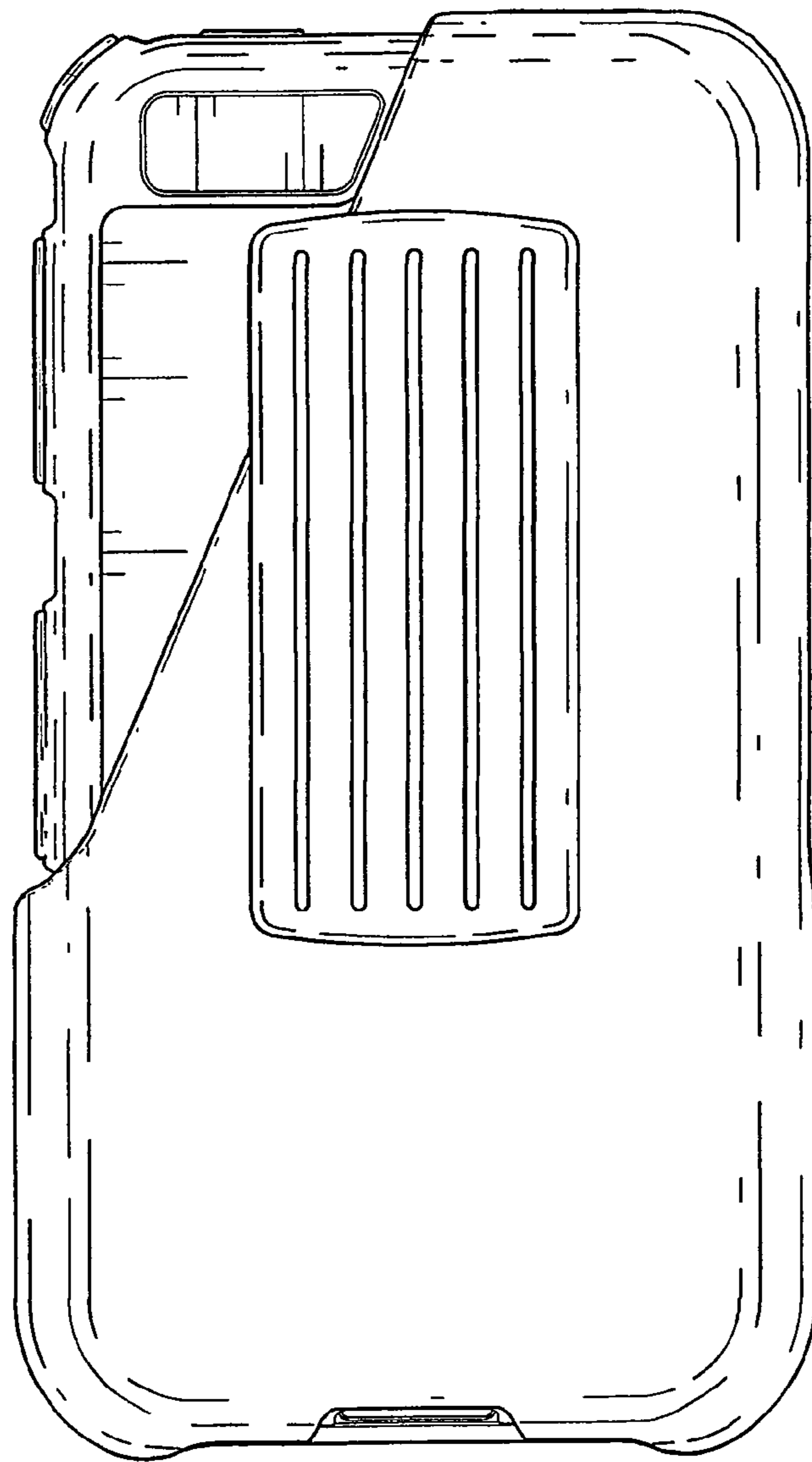

FIG. 4

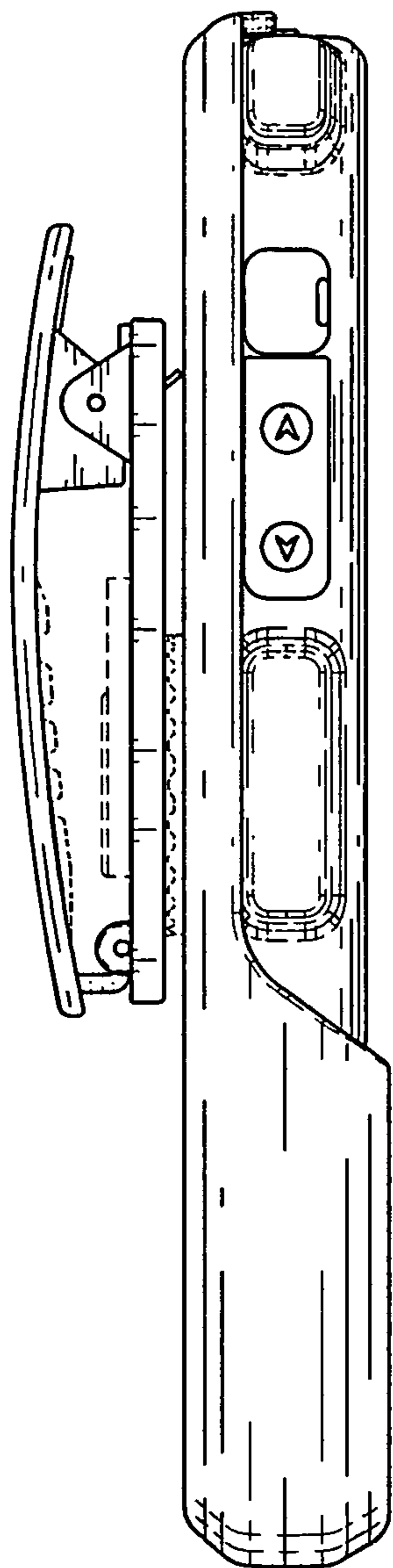

FIG. 5

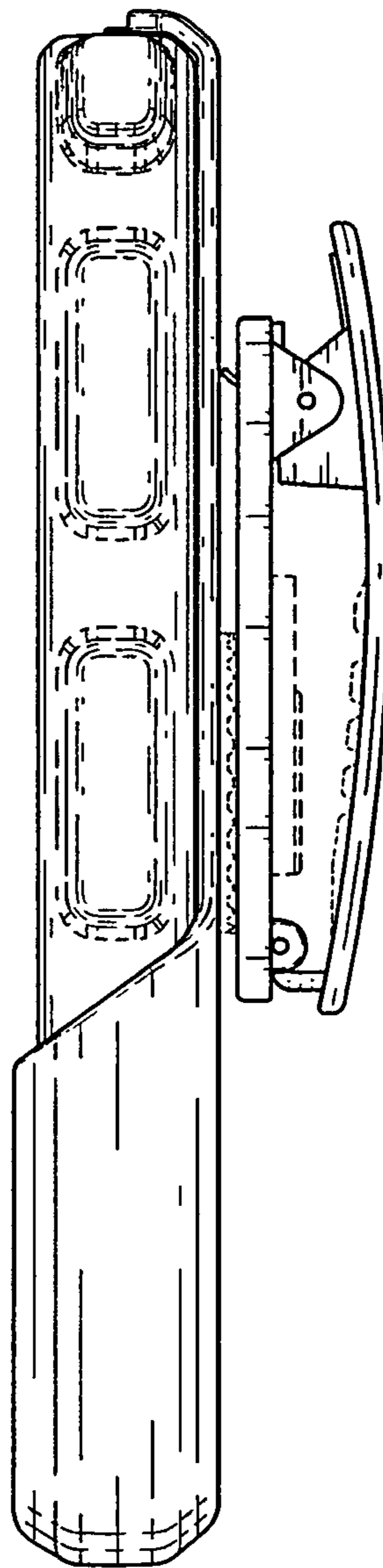

FIG. 6

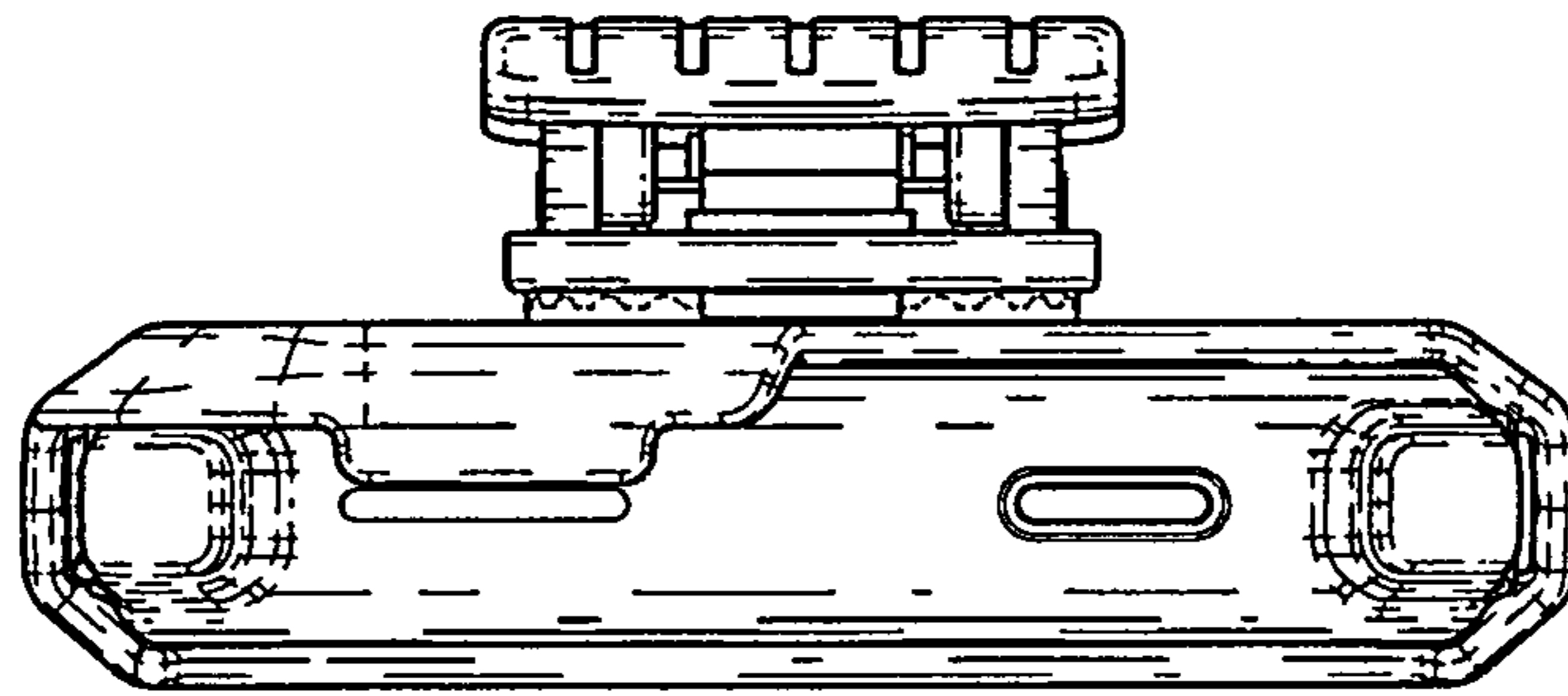

FIG. 7

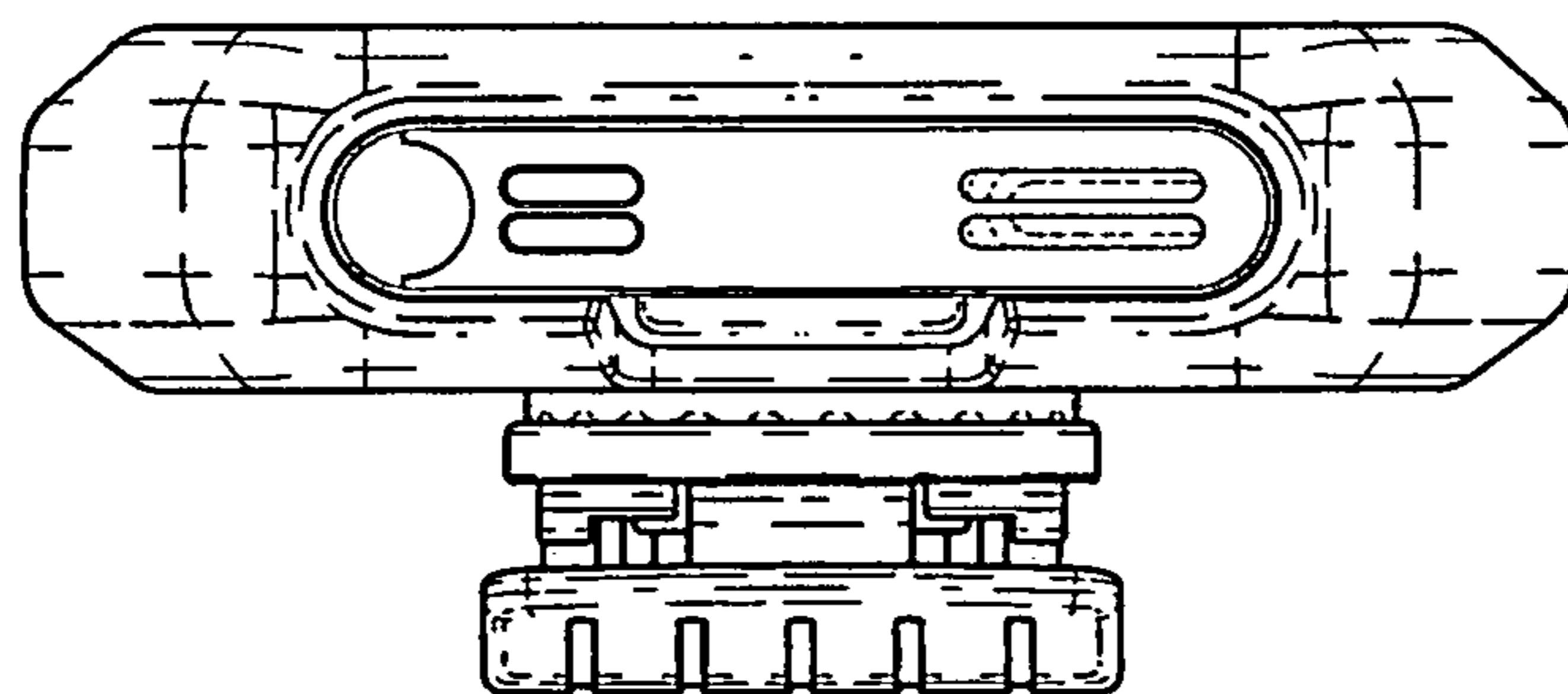
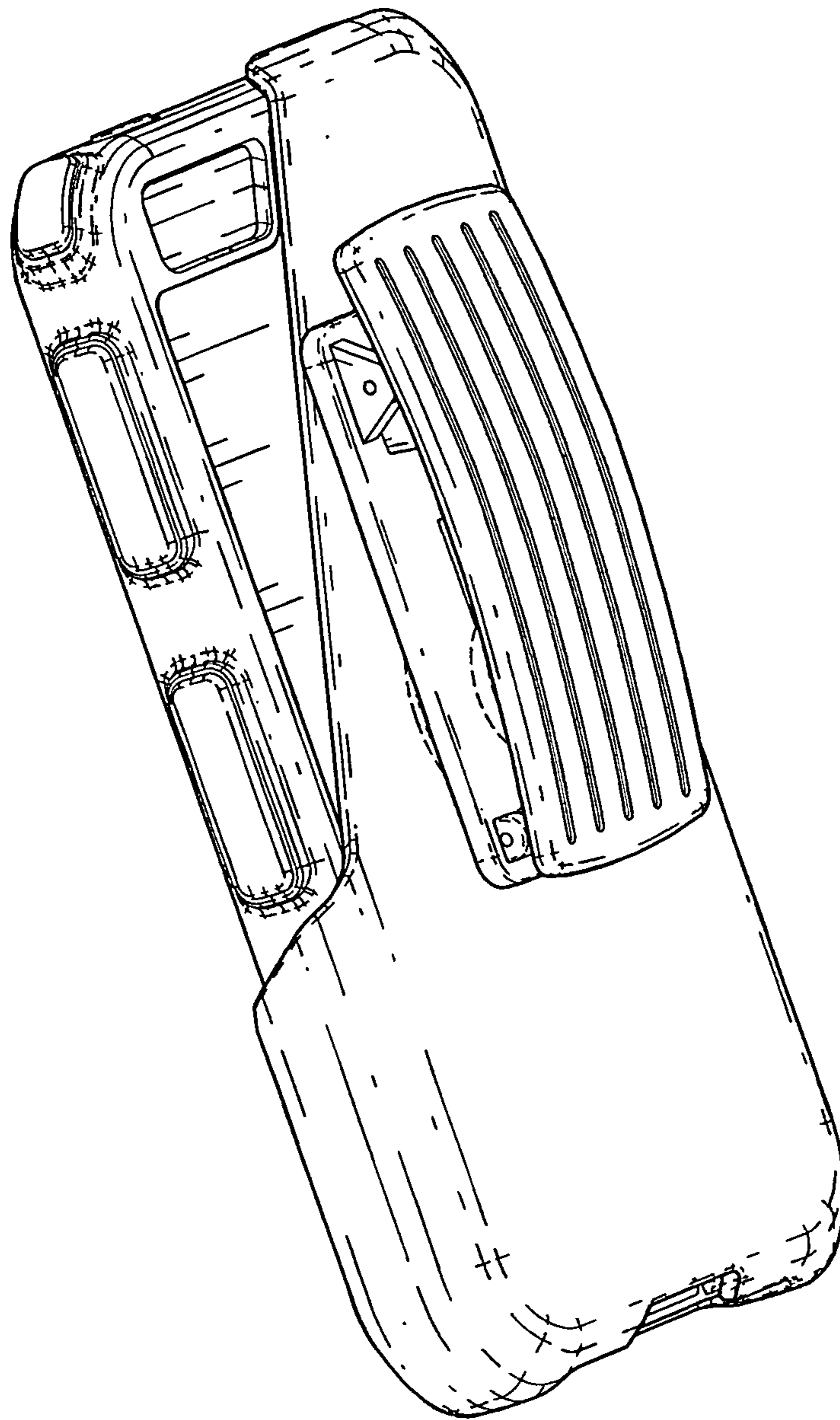

FIG. 8



**FIG. 9**