



US00D724066S

(12) **United States Design Patent**  
**Fathollahi**

(10) **Patent No.:** **US D724,066 S**  
(45) **Date of Patent:** **\*\* Mar. 10, 2015**

- (54) **CASE**
- (75) Inventor: **Andy Fathollahi**, Corona Del Mar, CA (US)
- (73) Assignee: **Incipio Technologies, Inc.**, Irvine, CA (US)
- (\*\*) Term: **14 Years**
- (21) Appl. No.: **29/412,881**
- (22) Filed: **Feb. 8, 2012**
- (51) **LOC (10) Cl.** ..... **14-03**
- (52) **U.S. Cl.**  
USPC ..... **D14/250**
- (58) **Field of Classification Search**  
USPC ..... D3/201, 215, 218, 269, 273, 294;  
D14/140, 142, 203.3, 217, 218, 240,  
D14/242, 250–253, 299, 358, 440, 450;  
D13/103, 107, 108.119; 220/4.02;  
224/119, 191, 240, 241, 245, 682, 683;  
248/309.1; 361/679.3, 679.56;  
379/454, 455; 455/575.1, 575.6, 575.7,  
455/575.8, 575.9; 190/100; 206/305, 320  
See application file for complete search history.

- 7,180,735 B2 2/2007 Thomas et al.
- D545,189 S \* 6/2007 El-Afandi et al. .... D9/434
- 7,230,823 B2 6/2007 Richardson et al.
- D546,177 S \* 7/2007 El-Afandi et al. .... D9/434
- D546,679 S \* 7/2007 El-Afandi et al. .... D9/434
- 7,312,984 B2 12/2007 Richardson et al.
- D565,290 S 4/2008 Brandenburg et al.
- D575,056 S 8/2008 Tan
- D586,851 S 2/2009 Lapsker
- D589,016 S 3/2009 Richardson et al.
- D589,482 S 3/2009 Lee et al.
- D589,486 S 3/2009 He
- D593,746 S 6/2009 Richardson et al.
- D597,301 S 8/2009 Richardson et al.

(Continued)

*Primary Examiner* — Randall Gholson  
(74) *Attorney, Agent, or Firm* — Manatt, Phelps & Philips, LLP

(57) **CLAIM**  
I claim the ornamental design for a case, as shown and described.

**DESCRIPTION**

FIG. 1 is a front perspective view of a case embodying my new design;  
FIG. 2 is a rear perspective view of the case of FIG. 1;  
FIG. 3 is a front view of the case of FIG. 1;  
FIG. 4 is a rear view of the case of FIG. 1;  
FIG. 5 is a left side view of the case of FIG. 1;  
FIG. 6 is a right side view of the case of FIG. 1;  
FIG. 7 is a top end view of the case of FIG. 1; and,  
FIG. 8 is a bottom end view of the case of FIG. 1.  
The broken lines in FIGS. 1-8 having a dash-dash configuration depict environmental subject matter and form no part of the claimed design. The broken lines in FIGS. 1-8 showing a dot-dash configuration constitute the border of the patented subject matter.

**1 Claim, 6 Drawing Sheets**

- (56) **References Cited**  
U.S. PATENT DOCUMENTS
- D250,974 S 1/1979 Donley et al.
- D317,255 S 6/1991 Turk
- D337,435 S 7/1993 Kaneko et al.
- D368,369 S 4/1996 Pease
- 6,239,968 B1 5/2001 Kim et al.
- 6,445,577 B1 9/2002 Madsen et al.
- 6,519,141 B2 2/2003 Tseng et al.
- 6,646,864 B2 11/2003 Richardson
- 6,995,976 B2 2/2006 Richardson
- 7,158,376 B2 1/2007 Richardson et al.

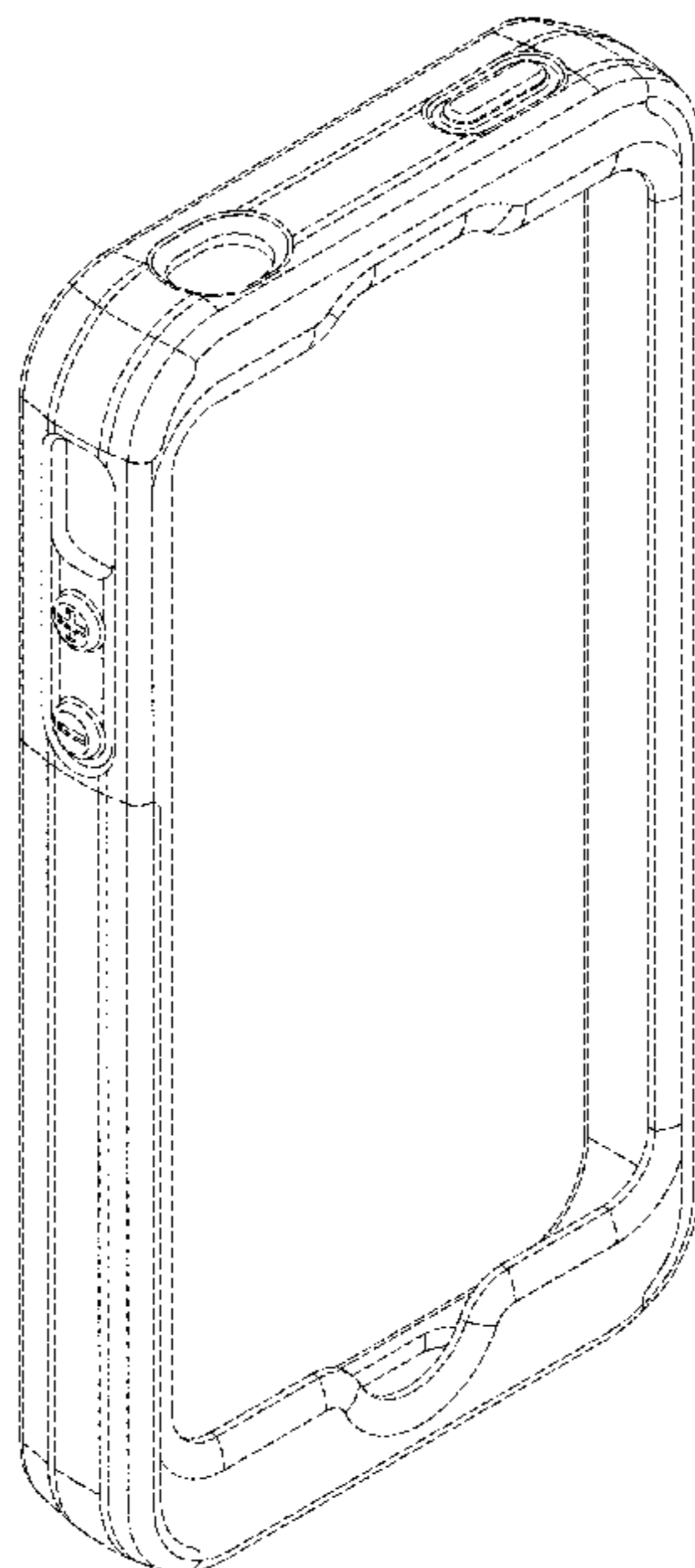

(56)

**References Cited**

U.S. PATENT DOCUMENTS

D600,908 S	9/2009	Richardson et al.	8,016,107 B2	9/2011	Emsky
7,609,512 B2	10/2009	Richardson et al.	D647,519 S	10/2011	Rothbaum et al.
D603,602 S	11/2009	Richardson et al.	D648,301 S	11/2011	Zuffo et al.
D603,603 S	11/2009	Laine et al.	8,132,670 B1	3/2012	Chen
D605,850 S	12/2009	Richardson et al.	D663,263 S	7/2012	Gupta et al.
D609,463 S	2/2010	Bullen	D665,735 S	8/2012	Kang et al.
D609,900 S	2/2010	Behar et al.	8,245,843 B1	8/2012	Wu
7,663,879 B2	2/2010	Richardson et al.	2005/0247584 A1	11/2005	Lu
D616,361 S	5/2010	Huang	2008/0012383 A1	1/2008	Larson
D625,283 S	10/2010	Okada et al.	2008/0316687 A1	12/2008	Richardson et al.
D625,698 S	10/2010	Miyazaki et al.	2009/0009945 A1	1/2009	Johnson et al.
D635,555 S	4/2011	Giles	2009/0050499 A1	2/2009	Calco et al.
D642,170 S	7/2011	Johnson et al.	2009/0080153 A1	3/2009	Richardson et al.
			2009/0111543 A1	4/2009	Tai et al.
			2010/0008028 A1	1/2010	Richardson et al.
			2011/0036876 A1	2/2011	Fathollahi

\* cited by examiner

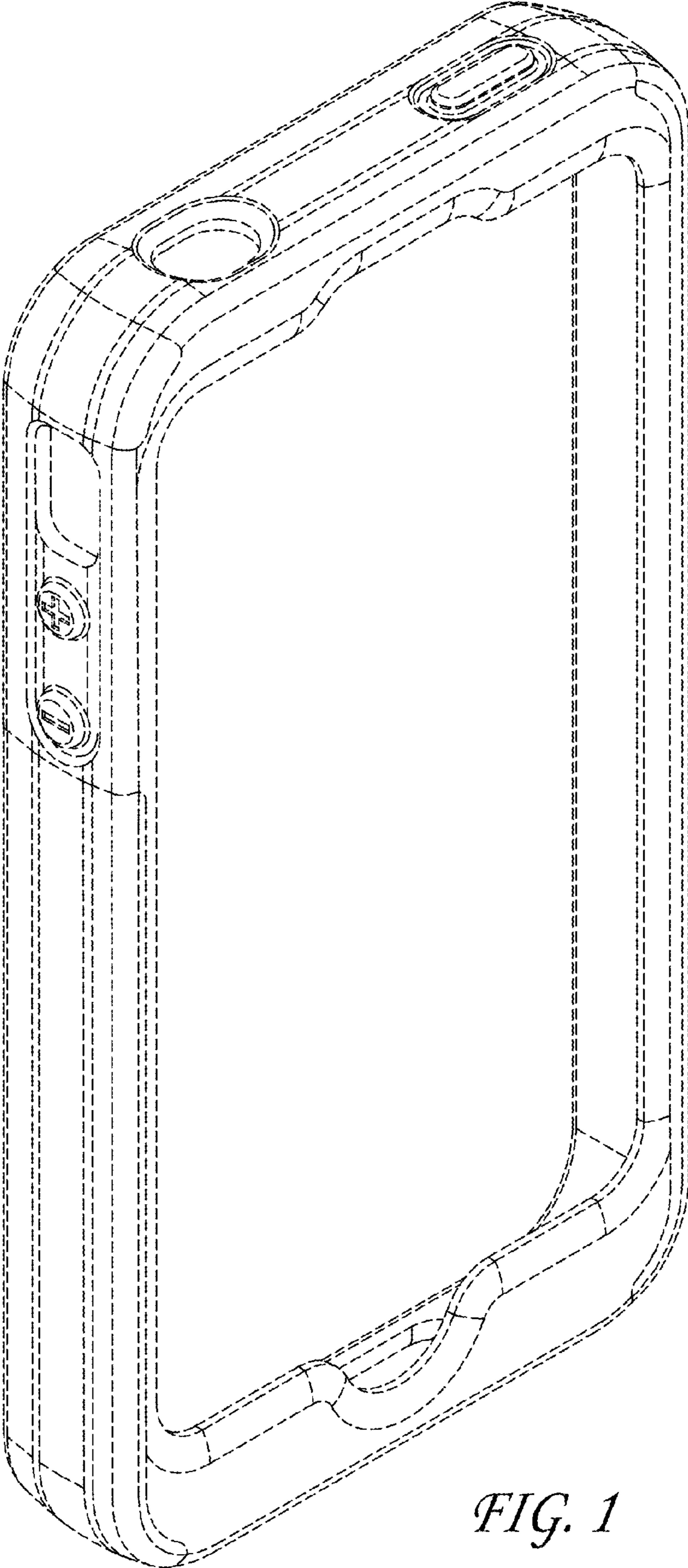
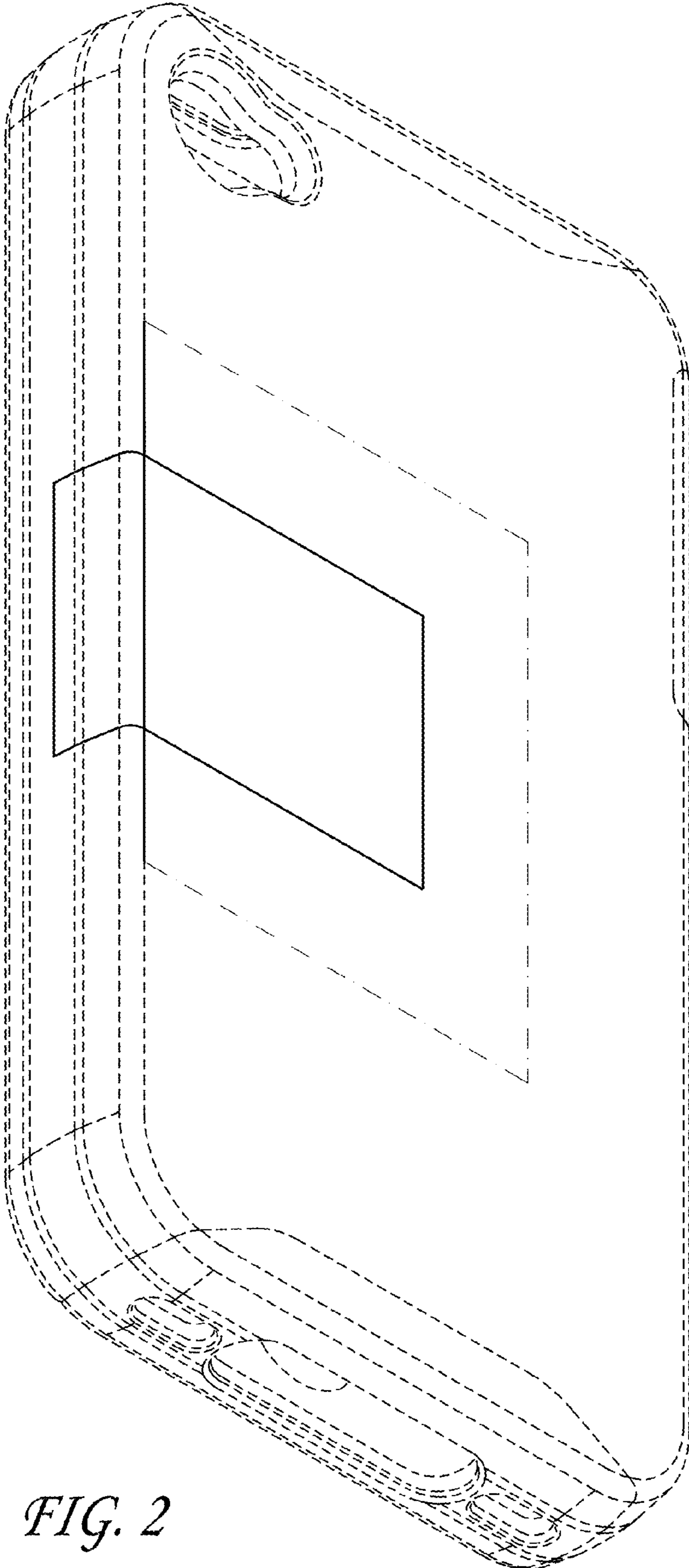

FIG. 1



*FIG. 2*

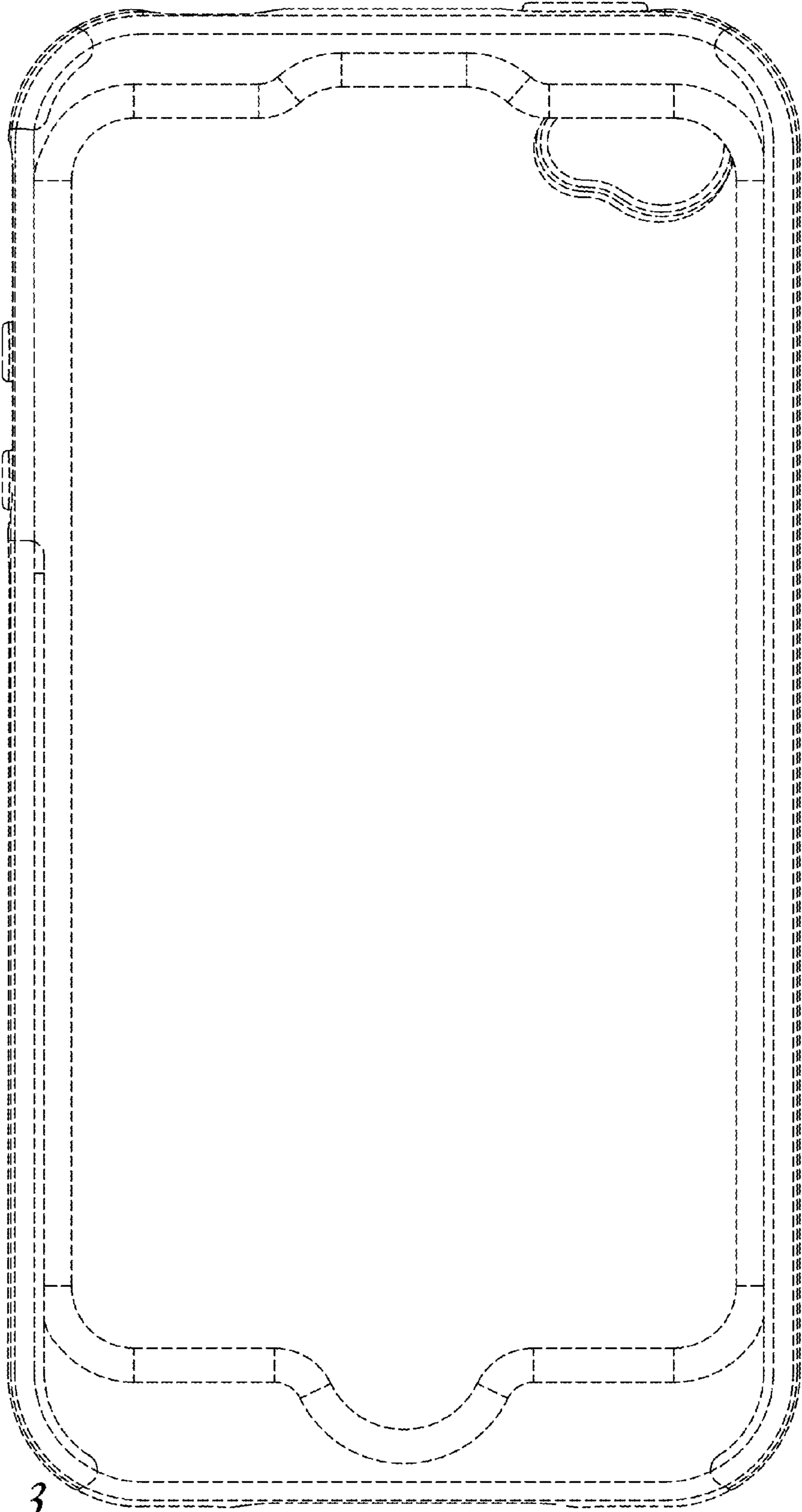

FIG. 3

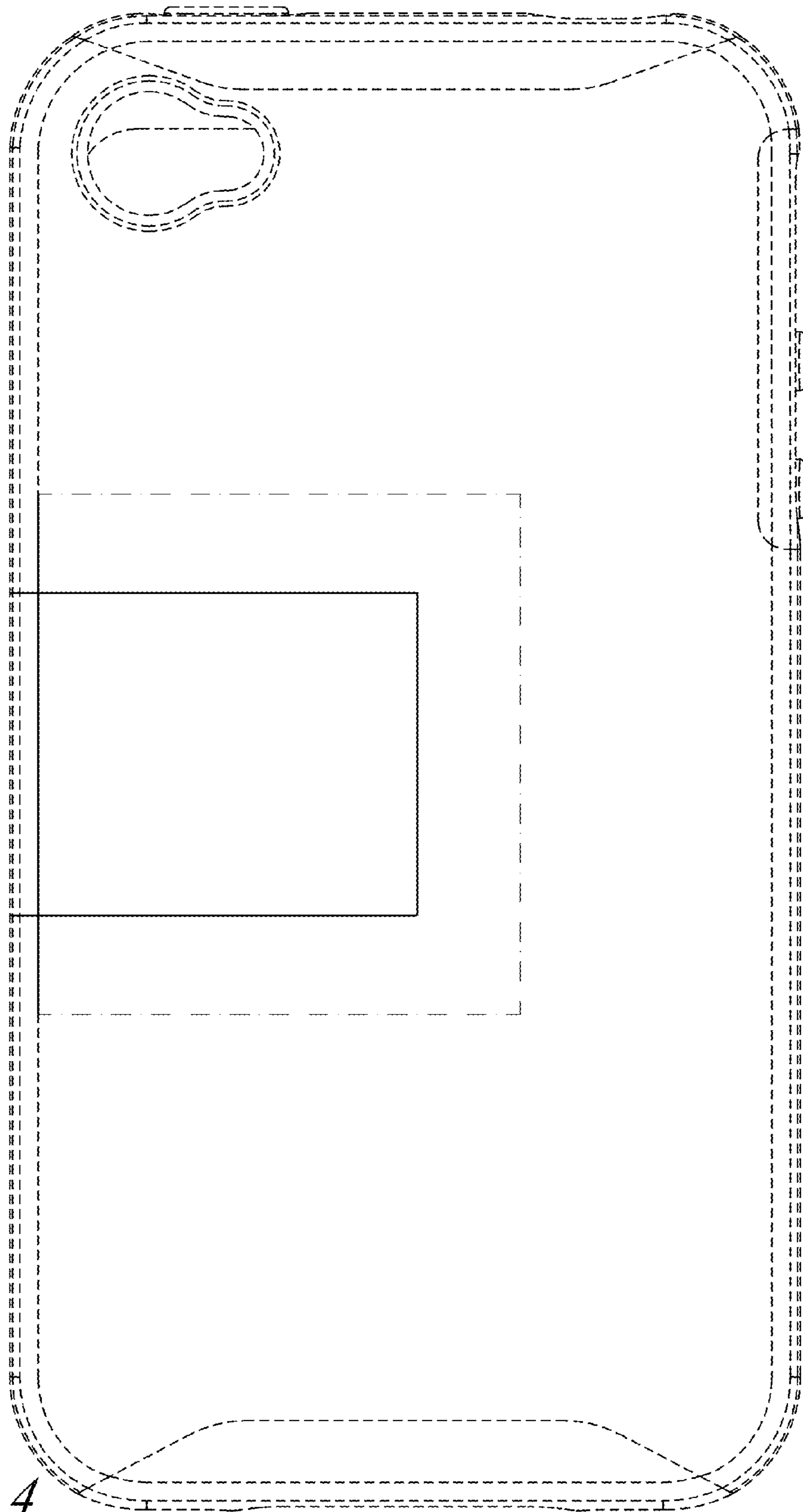
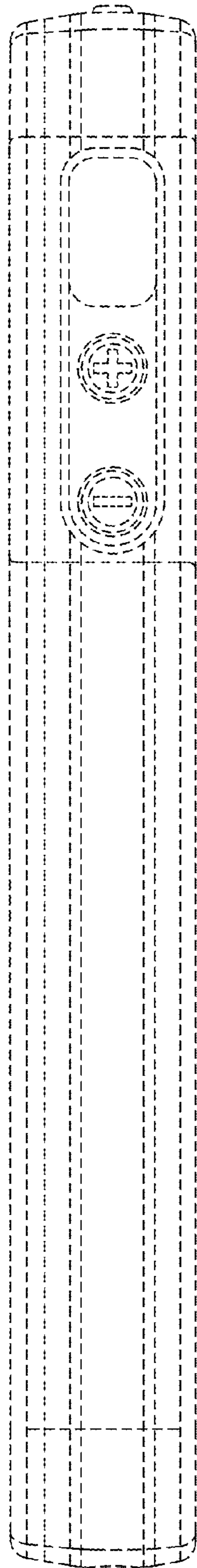
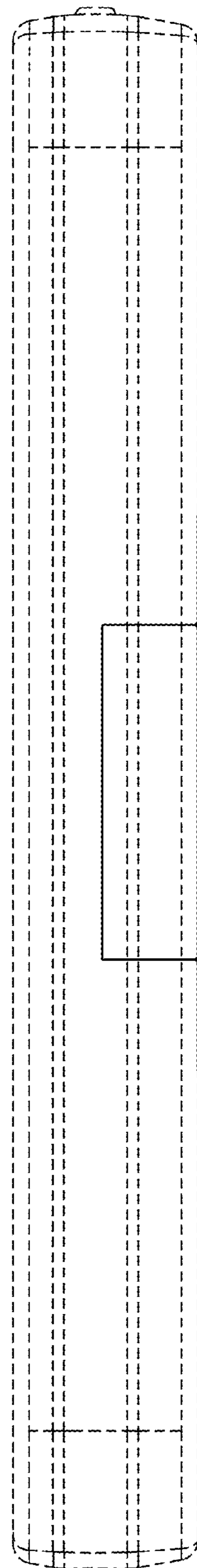

FIG. 4



*FIG. 5*



*FIG. 6*



*FIG. 7*

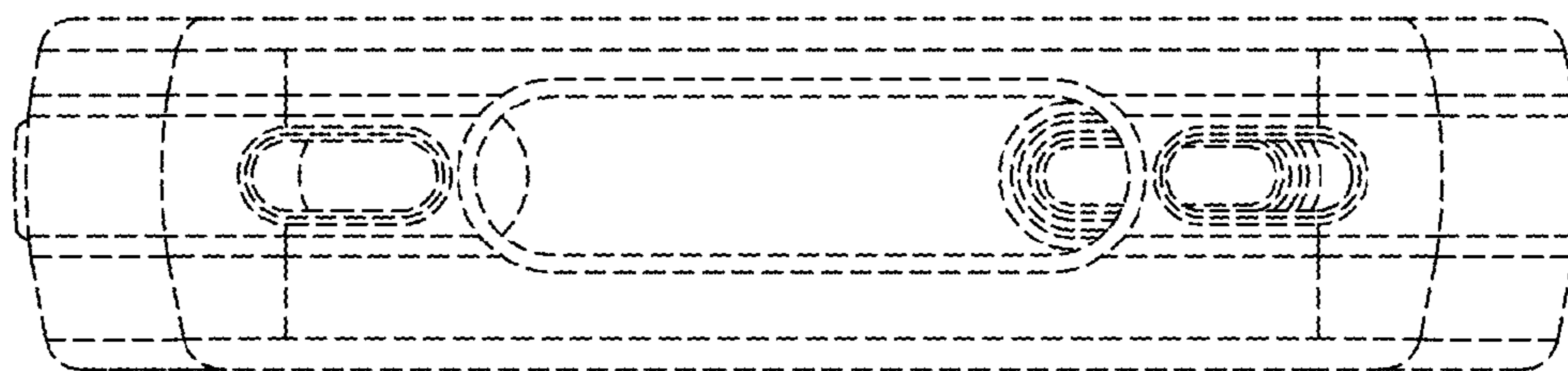

*FIG. 8*