



US00D724047S

(12) **United States Design Patent**  
**Kim et al.**

(10) **Patent No.:** **US D724,047 S**  
(45) **Date of Patent:** **\*\* Mar. 10, 2015**

(54) **MOBILE PHONE**

(71) Applicant: **LG Electronics Inc.**, Seoul (KR)

(72) Inventors: **Dongsoon Kim**, Yongin-si (KR);  
**Seunghyun Ji**, Seoul (KR); **Wonsang Choi**, Yongin-si (KR)

(73) Assignee: **LG Electronics Inc.**, Seoul (KR)

(\*\*) Term: **14 Years**

(21) Appl. No.: **29/480,808**

(22) Filed: **Jan. 29, 2014**

(30) **Foreign Application Priority Data**

Jul. 30, 2013 (KR) ..... 30-2013-0039389

(51) **LOC (10) Cl.** ..... **14-03**

(52) **U.S. Cl.**  
USPC ..... **D14/138 R**; D14/344; D10/38

(58) **Field of Classification Search**  
CPC ..... H04B 1/03; H04B 1/385; G04G 17/083  
USPC ..... D14/140, 137, 138 R, 138 AB, 139, 155,  
D14/191, 192, 203.1, 203.3, 203.4, 203.5,  
D14/203.7, 248, 226, 218, 144, 240, 344,  
D14/440, 341, 346, 448, 450, 496;  
D10/30-39, 70, 65, 78, 104.1, 104.2,  
D10/125; D11/3-5, 12, 19, 25; D13/168;  
D8/354, 366, 402, 499; D3/215;  
D15/199; 381/364, 151; 379/433.1;  
455/575.1, 556.1, 556.2, 558, 575.3,  
455/575.4, 575.6, 90.3; 368/10, 13, 69,  
368/223; D21/329; D24/167

See application file for complete search history.

(56) **References Cited**

**U.S. PATENT DOCUMENTS**

1,786,762 A \* 12/1930 Lyons ..... 368/281  
3,585,794 A \* 6/1971 Klingenberg ..... 368/281

3,735,585 A \* 5/1973 Takagi ..... 368/281  
D227,926 S \* 7/1973 Kohler ..... D10/39  
3,748,849 A \* 7/1973 Takagi ..... 368/292  
3,789,601 A \* 2/1974 Bergey ..... 368/69  
D239,512 S \* 4/1976 Tsukui ..... D10/38  
D244,916 S \* 7/1977 Ueno ..... D10/38

(Continued)

**OTHER PUBLICATIONS**

Vigorelli silicone (watch store). www.dezeen.com [online] p. 1-3 of 11. Uploaded Sep. 29, 2011 [retrieved on Oct. 8, 2014]. Retrieved from Internet: <http://www.dezeen.com/2012/06/13/dezeen-watch-store-vigorelli-silicone-by-matteo-ragni/>.\*

(Continued)

*Primary Examiner* — Susan Bennett Hattan

*Assistant Examiner* — Marie Fast Horse

(74) *Attorney, Agent, or Firm* — Birch, Stewart, Kolasch & Birch, LLP

(57) **CLAIM**

The ornamental design for a mobile phone, as shown and described.

**DESCRIPTION**

FIG. 1 is a perspective view of a mobile phone showing our new design;

FIG. 2 is a front view thereof;

FIG. 3 is a rear view thereof;

FIG. 4 is a left side view thereof;

FIG. 5 is a right side view thereof;

FIG. 6 is a top plan view thereof;

FIG. 7 is a bottom plan view thereof;

FIG. 8 is a perspective view thereof showing the state in which the display part is swivelled at an angle of 45 degrees; and,

FIG. 9 is a top plan view of FIG. 8.

The broken lines depict portions of the mobile phone that form no part of the claimed design.

**1 Claim, 9 Drawing Sheets**

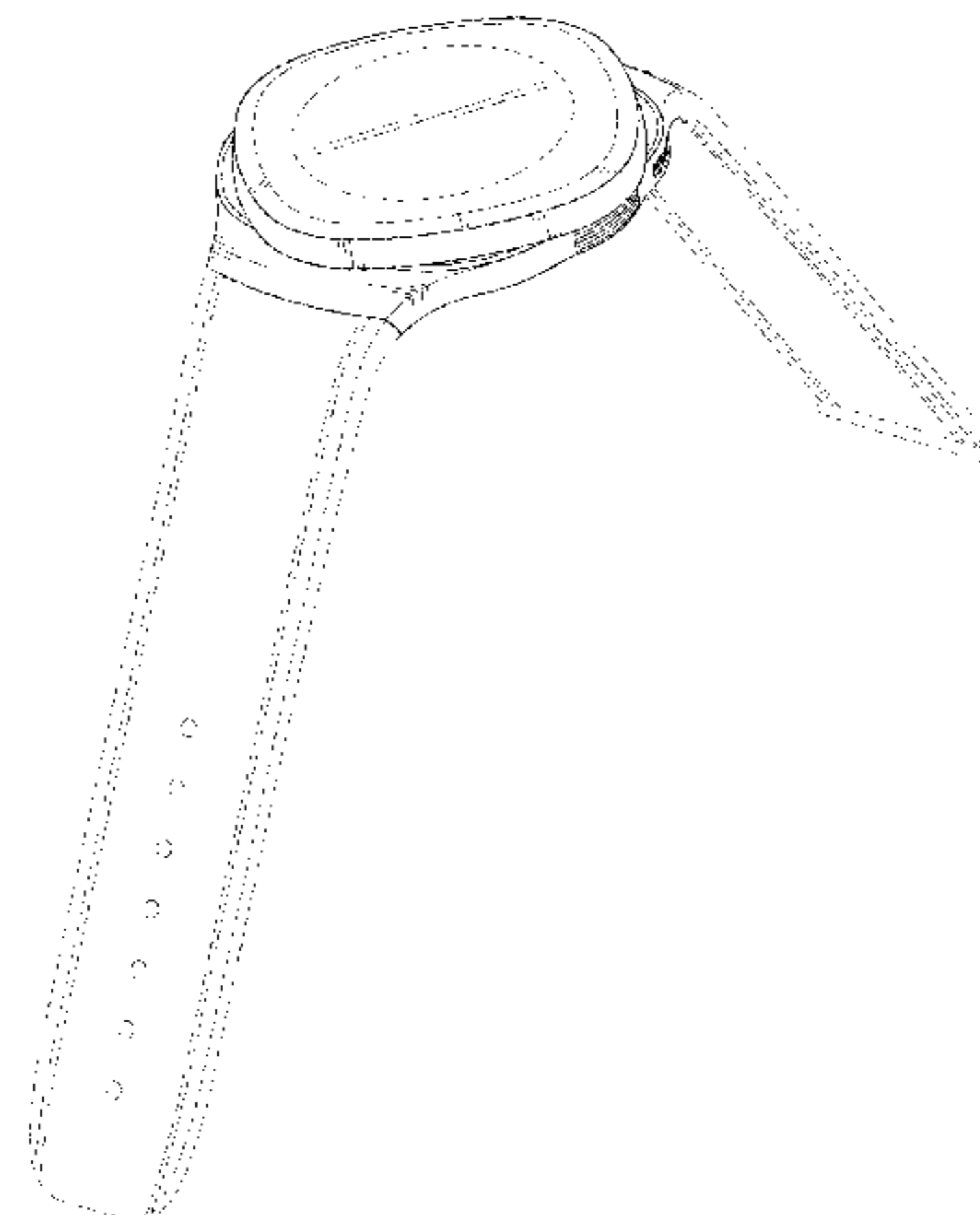
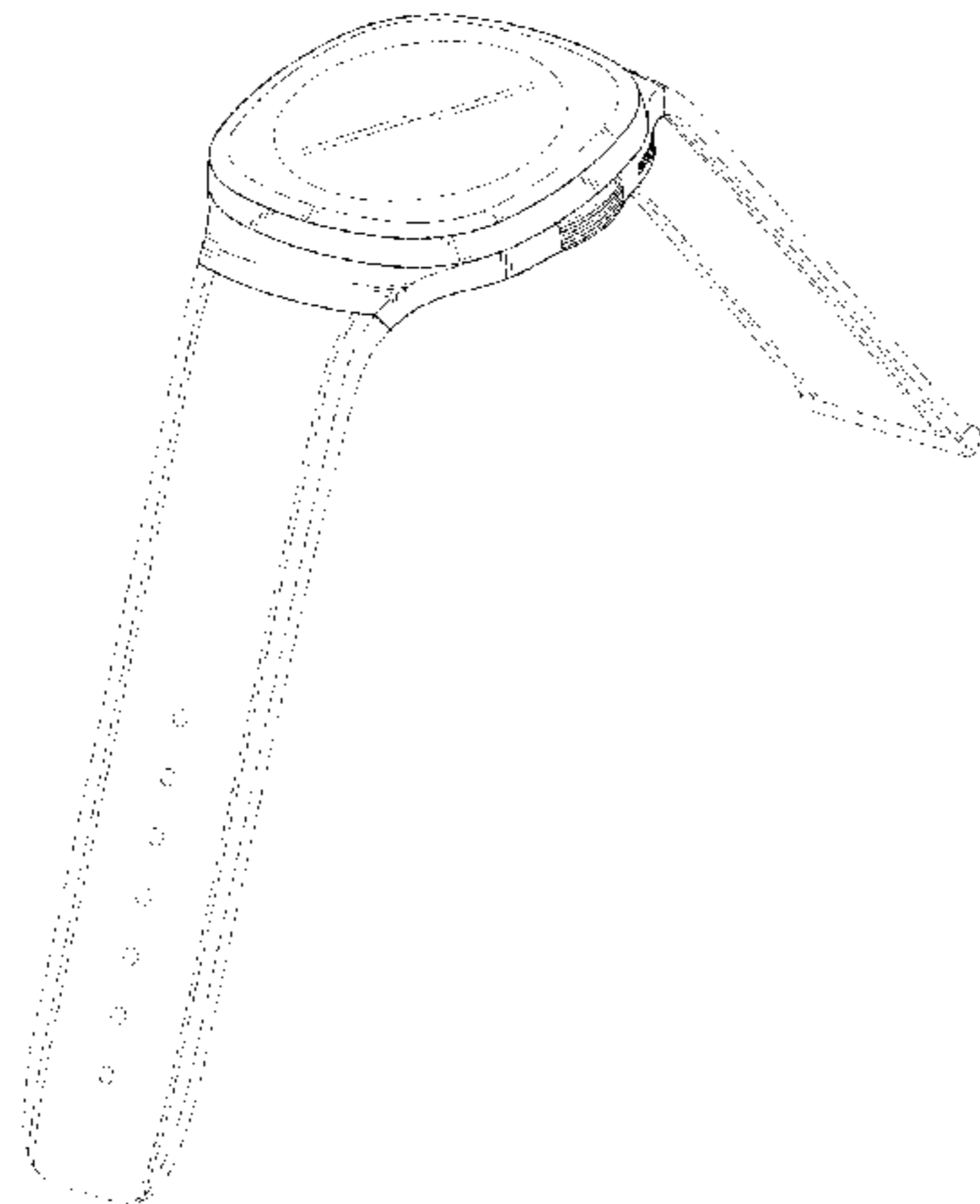

(56)

References Cited

U.S. PATENT DOCUMENTS

D245,400 S \* 8/1977 Osawa et al. .... D10/30  
 D246,576 S \* 12/1977 Inaba ..... D10/30  
 D247,701 S \* 4/1978 Kwon ..... D10/31  
 D248,223 S \* 6/1978 Sulek ..... D10/38  
 D256,677 S \* 9/1980 Muramatsu ..... D10/39  
 4,287,400 A \* 9/1981 Kitik et al. .... 200/302.3  
 D261,111 S \* 10/1981 Fukumura ..... D10/38  
 D261,112 S \* 10/1981 Fukumura ..... D10/38  
 D261,113 S \* 10/1981 Fukumura ..... D10/39  
 D264,946 S \* 6/1982 Hirabayashi ..... D10/38  
 D265,062 S \* 6/1982 Hirabayashi ..... D10/38  
 D265,063 S \* 6/1982 Iida ..... D10/38  
 D266,230 S \* 9/1982 Tsukahara ..... D10/38  
 4,444,513 A \* 4/1984 Proelochs et al. .... 368/223  
 D303,769 S \* 10/1989 Ando ..... D10/38  
 D331,020 S \* 11/1992 Ishii et al. .... D10/31  
 D340,414 S \* 10/1993 DeGraeve ..... D10/39  
 D500,682 S \* 1/2005 Lalo ..... D10/30  
 D561,612 S \* 2/2008 Finazzi ..... D10/38  
 D580,803 S \* 11/2008 Whittaker ..... D10/65  
 D584,170 S \* 1/2009 Morrison ..... D10/32  
 7,529,155 B2 \* 5/2009 Fasciano ..... 368/10  
 D632,192 S \* 2/2011 Jorst et al. .... D10/38  
 D638,725 S \* 5/2011 Morrison ..... D10/39  
 D645,360 S \* 9/2011 Kiser et al. .... D10/32  
 8,059,491 B1 \* 11/2011 Hennings-Kampa ..... 368/14  
 D660,726 S \* 5/2012 Register et al. .... D10/38  
 D680,651 S \* 4/2013 Lumme et al. .... D24/167  
 D692,784 S \* 11/2013 Anderssen et al. .... D10/70

D693,248 S \* 11/2013 Anderssen et al. .... D10/65  
 D693,249 S \* 11/2013 Anderssen et al. .... D10/65  
 D693,251 S \* 11/2013 Anderssen et al. .... D10/70  
 D693,709 S \* 11/2013 Lee et al. .... D10/70  
 D696,968 S \* 1/2014 Stegmann et al. .... D10/38  
 D712,755 S \* 9/2014 Stegmann ..... D10/38  
 D714,288 S \* 9/2014 Aumiller et al. .... D14/344  
 2003/0002394 A1 \* 1/2003 Kinkio et al. .... 368/281  
 2007/0279852 A1 \* 12/2007 Daniel et al. .... 361/683  
 2013/0001263 A1 \* 1/2013 Kai ..... 224/219  
 2014/0045547 A1 \* 2/2014 Singamsetty et al. .... 455/552.1

OTHER PUBLICATIONS

Squirle Watch. www.bustedtees.com [online] 2 pages. Uploaded Feb. 18, 2013 [retrieved on Oct. 8, 2014]. Retrieved from Internet: <<https://web.archive.org/web/20130218172958/http://www.bustedtees.com/squirlewatch/>>.\*  
 Swatch Touch Watches Look Great, Get Rid of Buttons. technabob.com [online] 1 page. Uploaded Sep. 29, 2011 [retrieved on Oct. 8, 2014]. Retrieved from Internet: <<http://technabob.com/blog/2011/09/29/swatch-touch-watches/>>.\*  
 Casio-la670wga-9df. lelong.com[online] 1 page. Jan. 29, 2014 [retrieved on Oct. 8, 2014]. Retrieved from Internet: <<http://www.lelong.com.my/9733-cny-promo-9733-casio-la670wga-9df-mini-classic-gold-retro-watch-imywatch-123175165-2014-01-Sale-P.htm>>.\*  
 Lorenz Vigorelli Watch. watches-on-time.com[online] p. 1 of 3. Apr. 22, 2012 [retrieved on Oct. 8, 2014]. Retrieved from Internet: <<http://watches-on-time.com/2012/04/lorenz-vigorelli/>>.\*

\* cited by examiner

FIG. 1

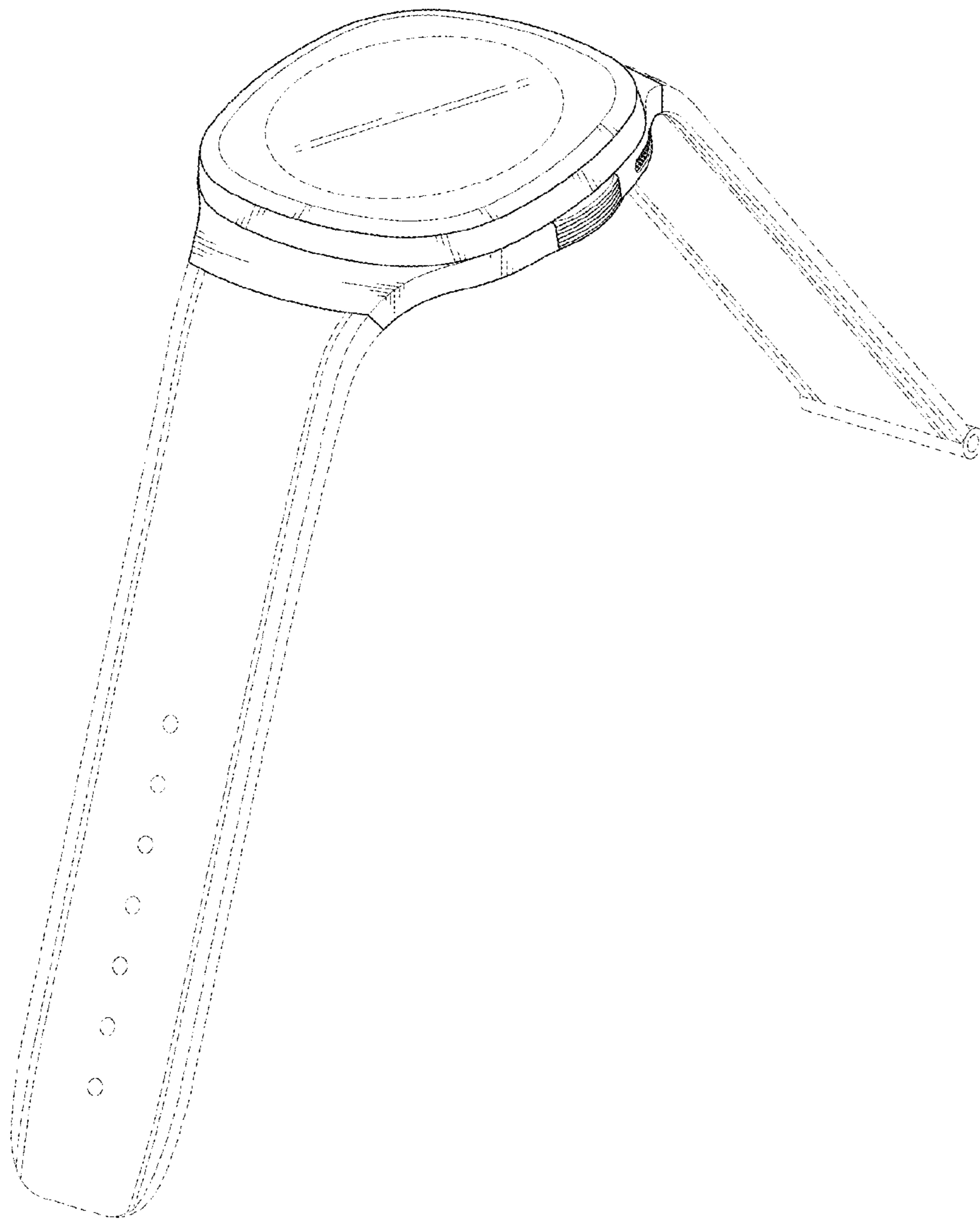

FIG. 2

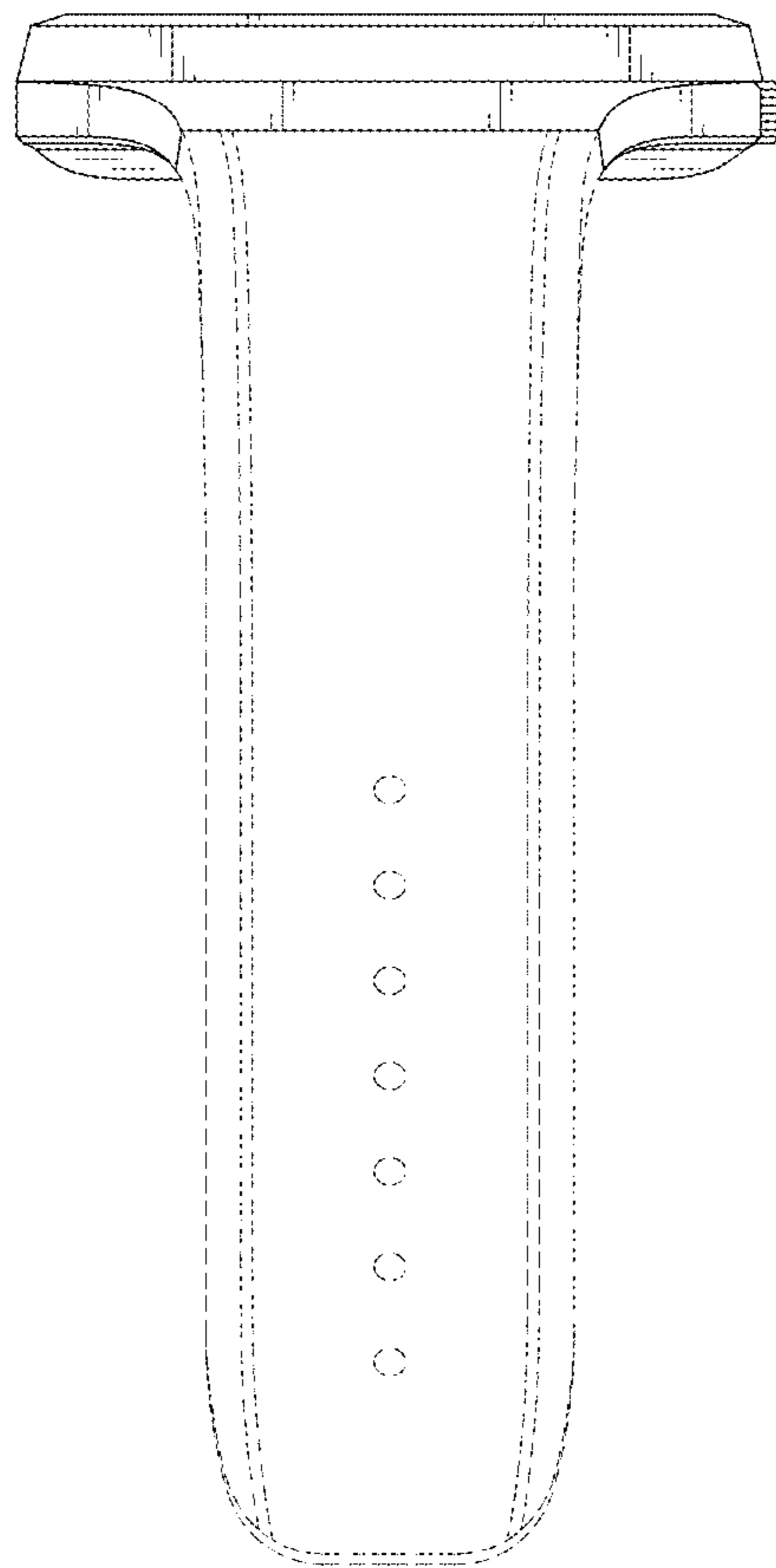

FIG. 3

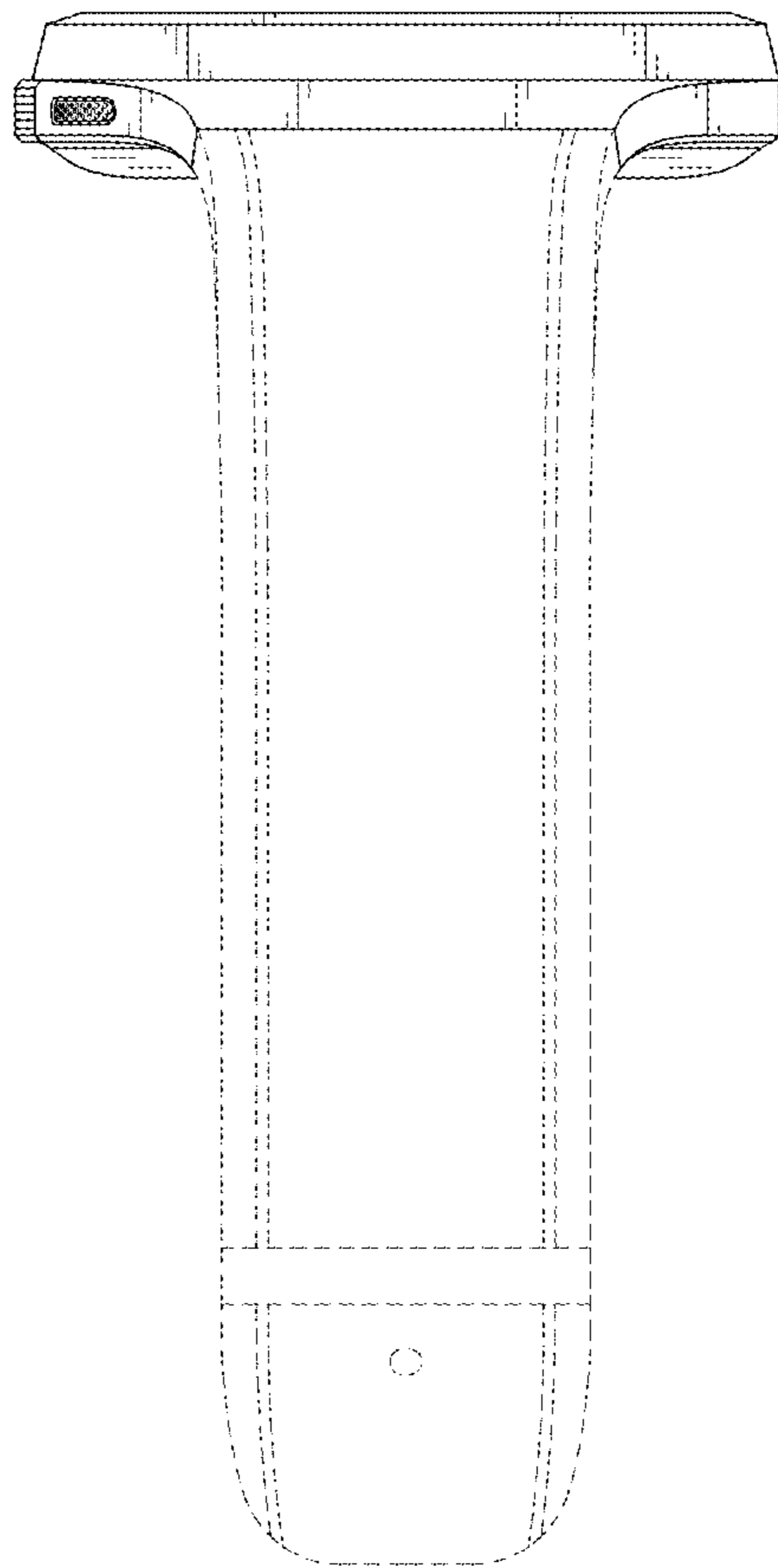

FIG. 4

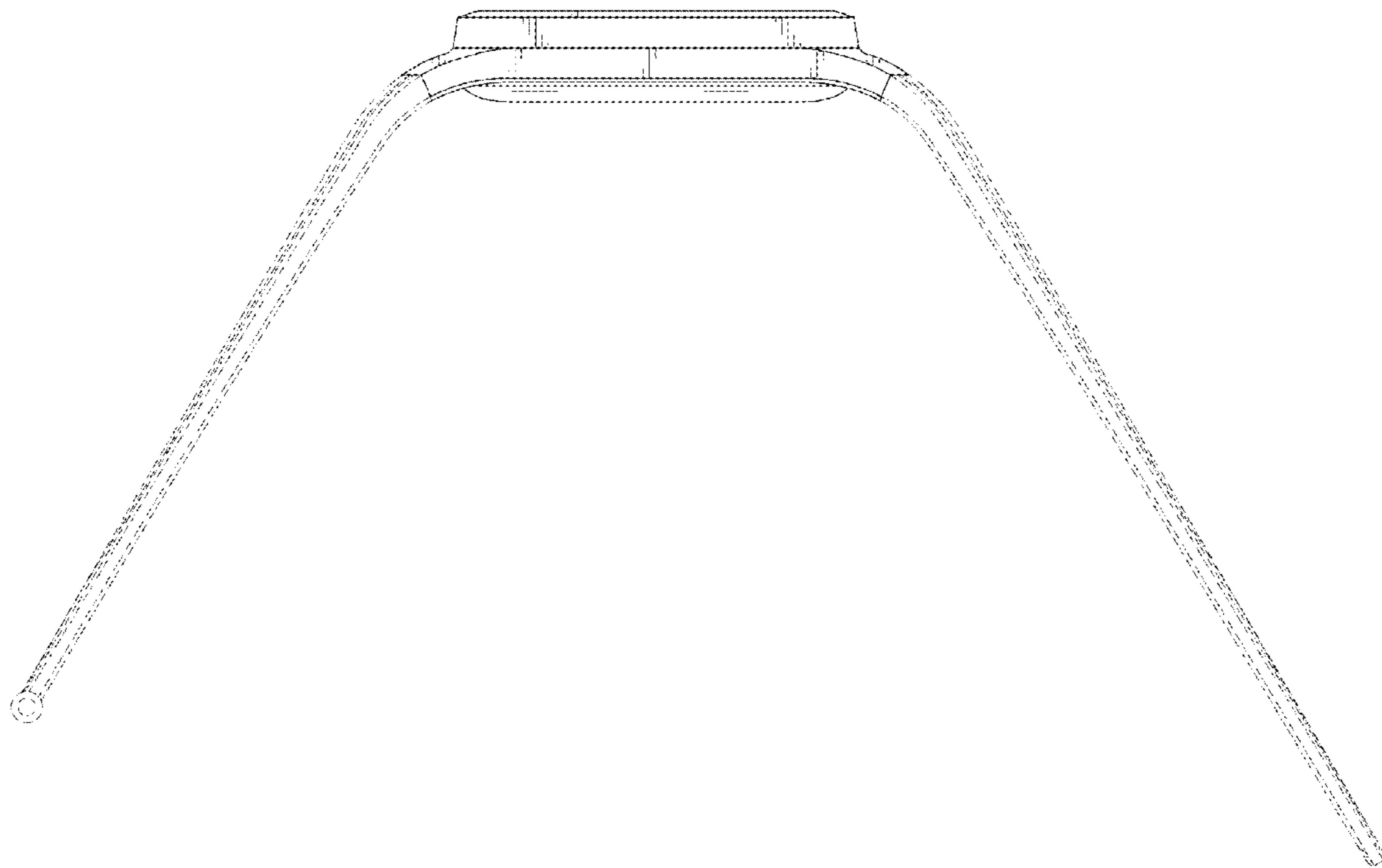



FIG. 5

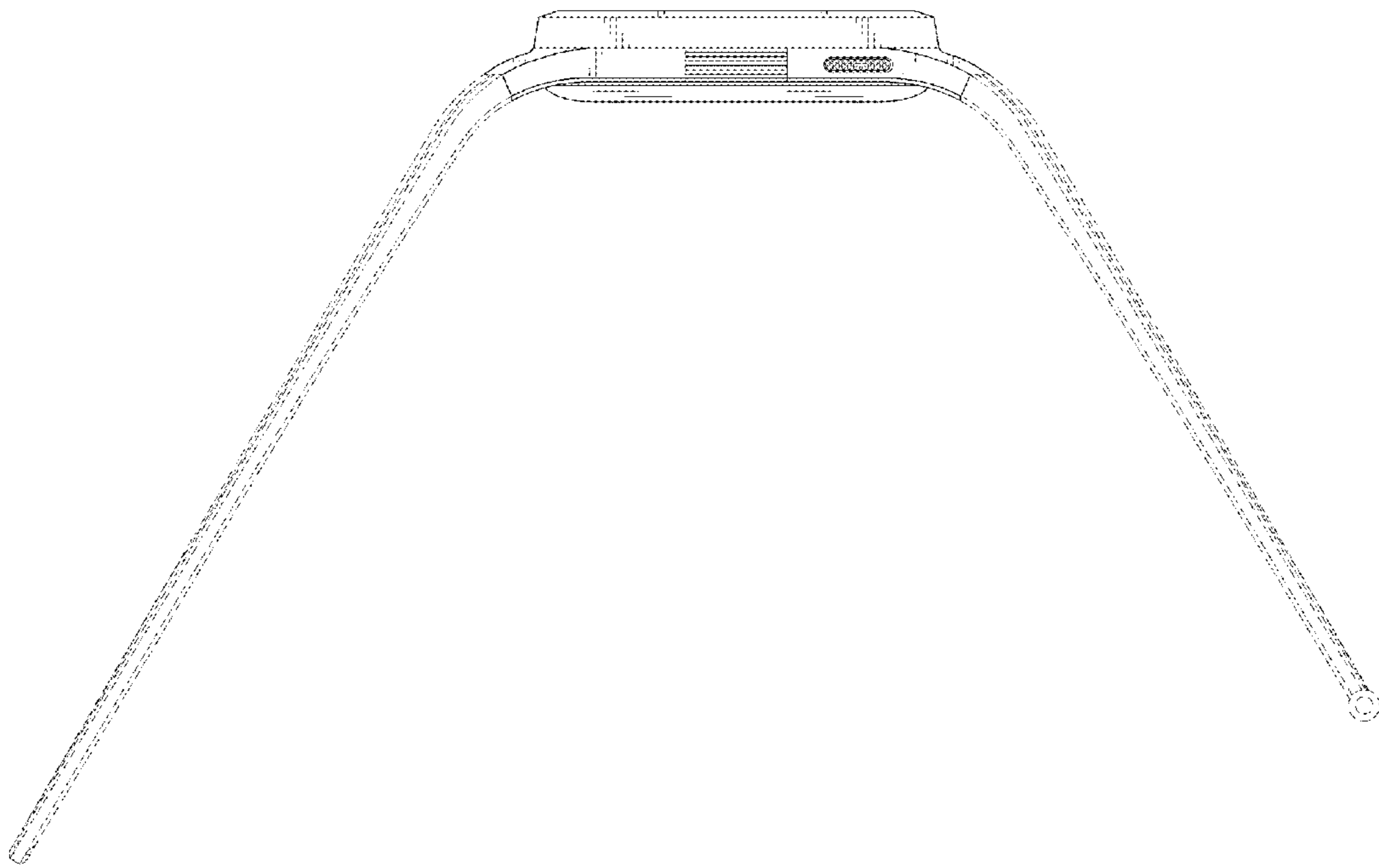

FIG. 6

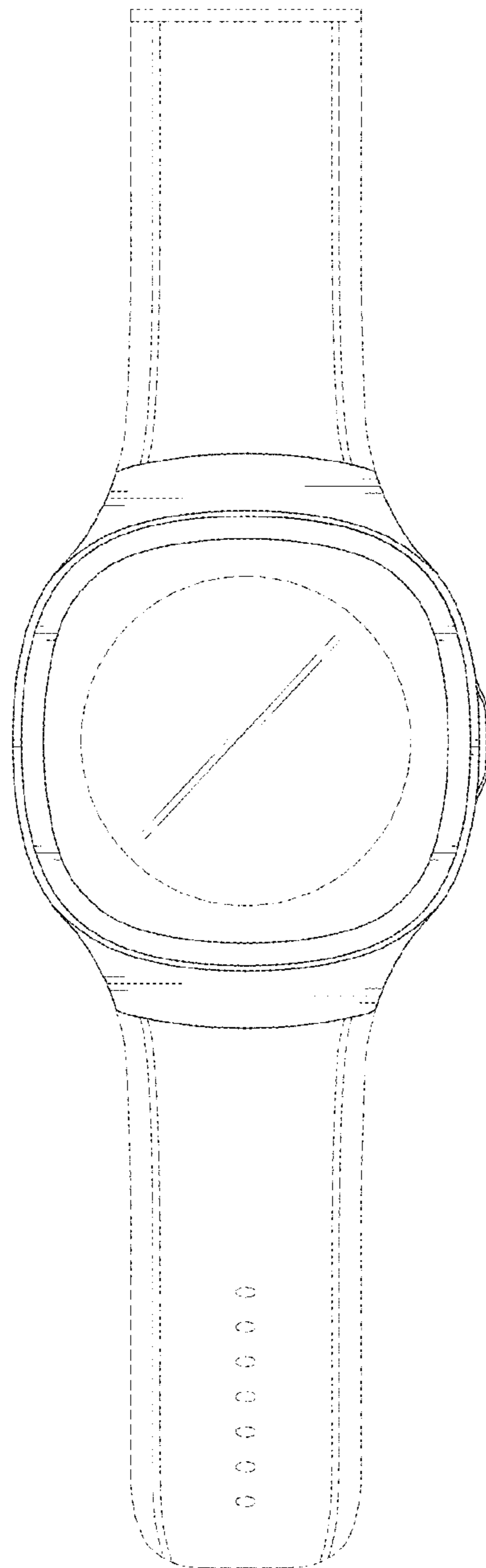



FIG. 7

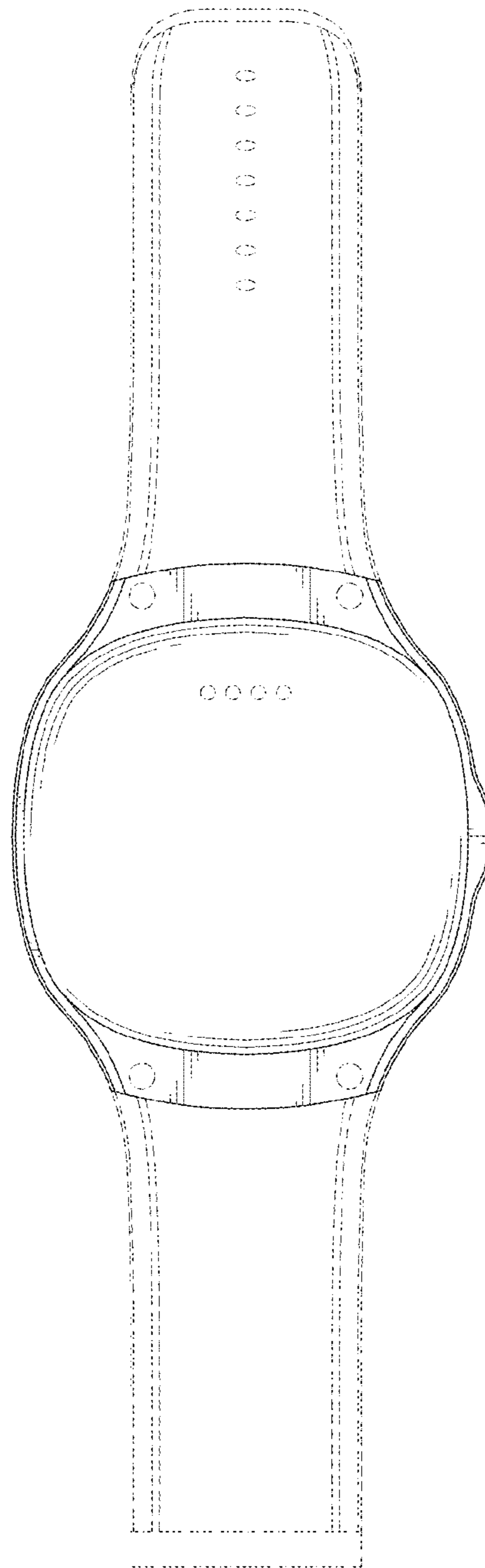

FIG. 8

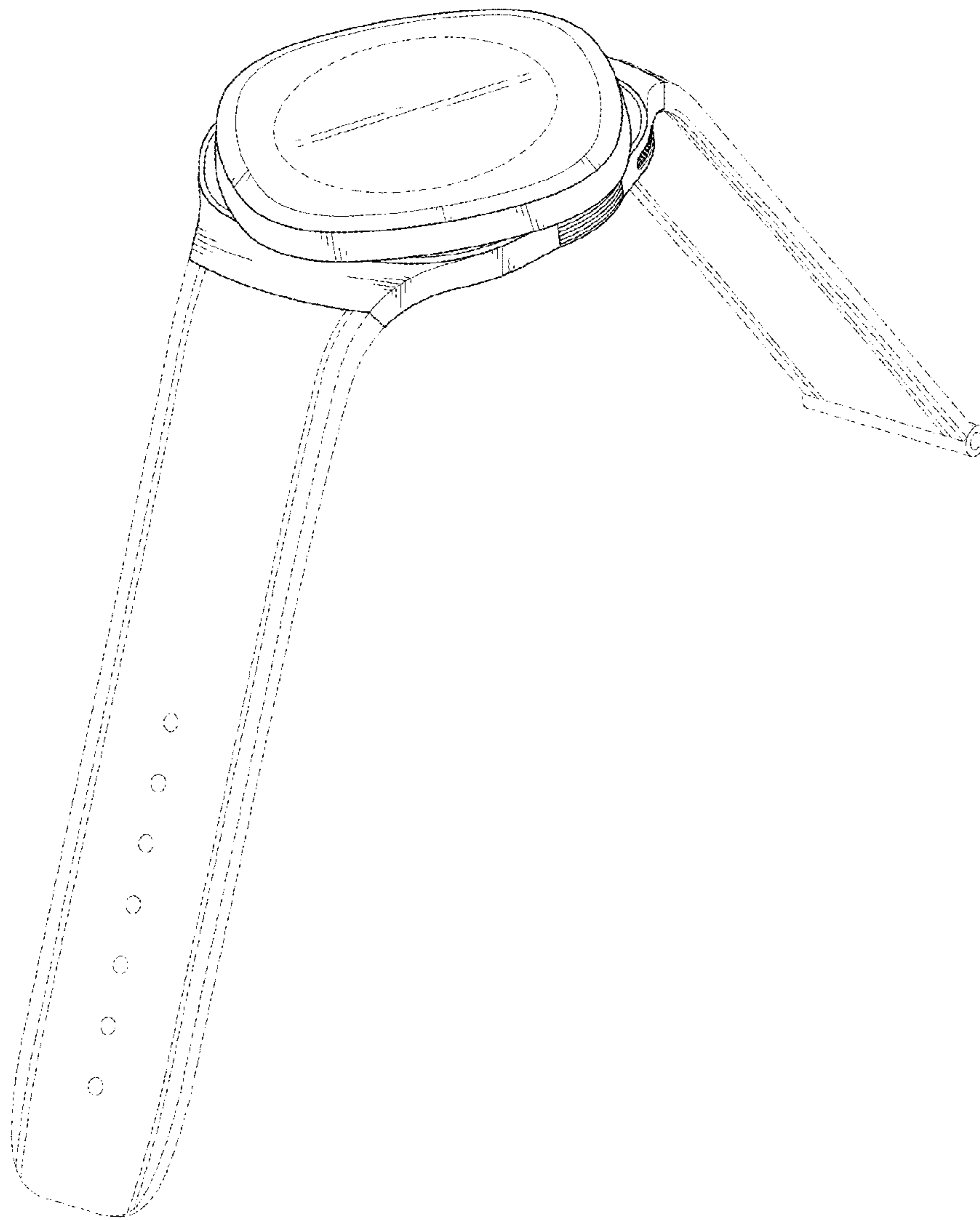

FIG. 9

