



US00D724033S

(12) **United States Design Patent**  
**Shimamoto et al.**

(10) **Patent No.:** **US D724,033 S**  
(45) **Date of Patent:** **\*\* Mar. 10, 2015**

(54) **HEAT MEDIUM RELAY UNIT**

- (71) Applicant: **Mitsubishi Electric Corporation**,  
Chiyoda-ku, Tokyo (JP)
- (72) Inventors: **Daisuke Shimamoto**, Chiyoda-ku (JP);  
**Osamu Morimoto**, Tokyo (JP);  
**Takayoshi Honda**, Tokyo (JP); **Koji**  
**Azuma**, Tokyo (JP); **Koji Nishioka**,  
Tokyo (JP)
- (73) Assignee: **Mitsubishi Electric Corporation**,  
Tokyo (JP)
- (\*\*) Term: **14 Years**
- (21) Appl. No.: **29/470,217**
- (22) Filed: **Oct. 18, 2013**

**Related U.S. Application Data**

- (62) Division of application No. 29/425,941, filed on Jun.  
28, 2012, now Pat. No. Des. 700,581.

(30) **Foreign Application Priority Data**

Apr. 11, 2012	(JP)	.....	2012-008484
Apr. 11, 2012	(JP)	.....	2012-008485
Apr. 11, 2012	(JP)	.....	2012-008486
Apr. 11, 2012	(JP)	.....	2012-008487

(51) **LOC (10) Cl.** ..... **13-03**

(52) **U.S. Cl.**  
USPC ..... **D13/159**

(58) **Field of Classification Search**

CPC ..... H01H 13/705; H01H 13/88; H01H  
2011/0087; H01H 2205/016; H01H 2221/05;  
H01H 2227/016; H01H 2227/026; H01H  
2229/02; H01H 2229/036; H01H 13/04;  
H01H 13/48; H01H 1/58; H01T 13/34;  
H02H 9/02

USPC ..... D13/110, 123, 146, 147, 151, 153, 154,  
D13/158-164, 171, 174, 184, 199;  
D14/240, 356-358, 434; 200/43.14,  
200/50.01, 50.21-50.23; 439/532, 536,  
439/540.1, 541.5, 613, 614, 884, 894, 895;  
361/42, 44, 50, 71, 115, 608, 622, 627,  
361/628, 634, 690

See application file for complete search history.

(56) **References Cited**

U.S. PATENT DOCUMENTS

D389,801 S *	1/1998	Foye	.....	D13/147
D396,695 S *	8/1998	Shen	.....	D13/147

(Continued)

*Primary Examiner* — Thomas Johannes

*Assistant Examiner* — Shawn T Gingrich

(74) *Attorney, Agent, or Firm* — Sughrue Mion, PLLC;  
Richard C. Turner

(57) **CLAIM**

The ornamental design for a heat medium relay unit, as shown  
and described.

**DESCRIPTION**

FIG. 1 is a front, top and right side perspective view of a heat  
medium relay unit, showing an embodiment of our new  
design;

FIG. 2 is a rear, top and left side perspective view thereof;

FIG. 3 is a front elevation view thereof;

FIG. 4 is a rear elevation view thereof;

FIG. 5 is a left side elevation view thereof;

FIG. 6 is a right side elevation view thereof;

FIG. 7 is a top plan view thereof;

FIG. 8 is a bottom plan view thereof;

FIG. 9 is a front, top and right side perspective view of a heat  
medium relay unit, showing a second embodiment of our  
design;

FIG. 10 is a rear, top and left side perspective view thereof;

FIG. 11 is a front elevation view thereof;

FIG. 12 is a rear elevation view thereof;

FIG. 13 is a left side elevation view thereof;

FIG. 14 is a right side elevation view thereof;

FIG. 15 is a top plan view thereof;

FIG. 16 is a bottom plan view thereof;

FIG. 17 is a front, top and right side perspective view of a heat  
medium relay unit, showing a third embodiment of our  
design;

FIG. 18 is a rear, top and left side perspective view thereof;

FIG. 19 is a front elevation view thereof;

FIG. 20 is a rear elevation view thereof;

FIG. 21 is a left side elevation view thereof;

FIG. 22 is a right side elevation view thereof;

FIG. 23 is a top plan view thereof; and,

FIG. 24 is a bottom plan view thereof.

The broken lines in all views show unclaimed subject matter  
only and form no part of the claimed design.

**1 Claim, 18 Drawing Sheets**

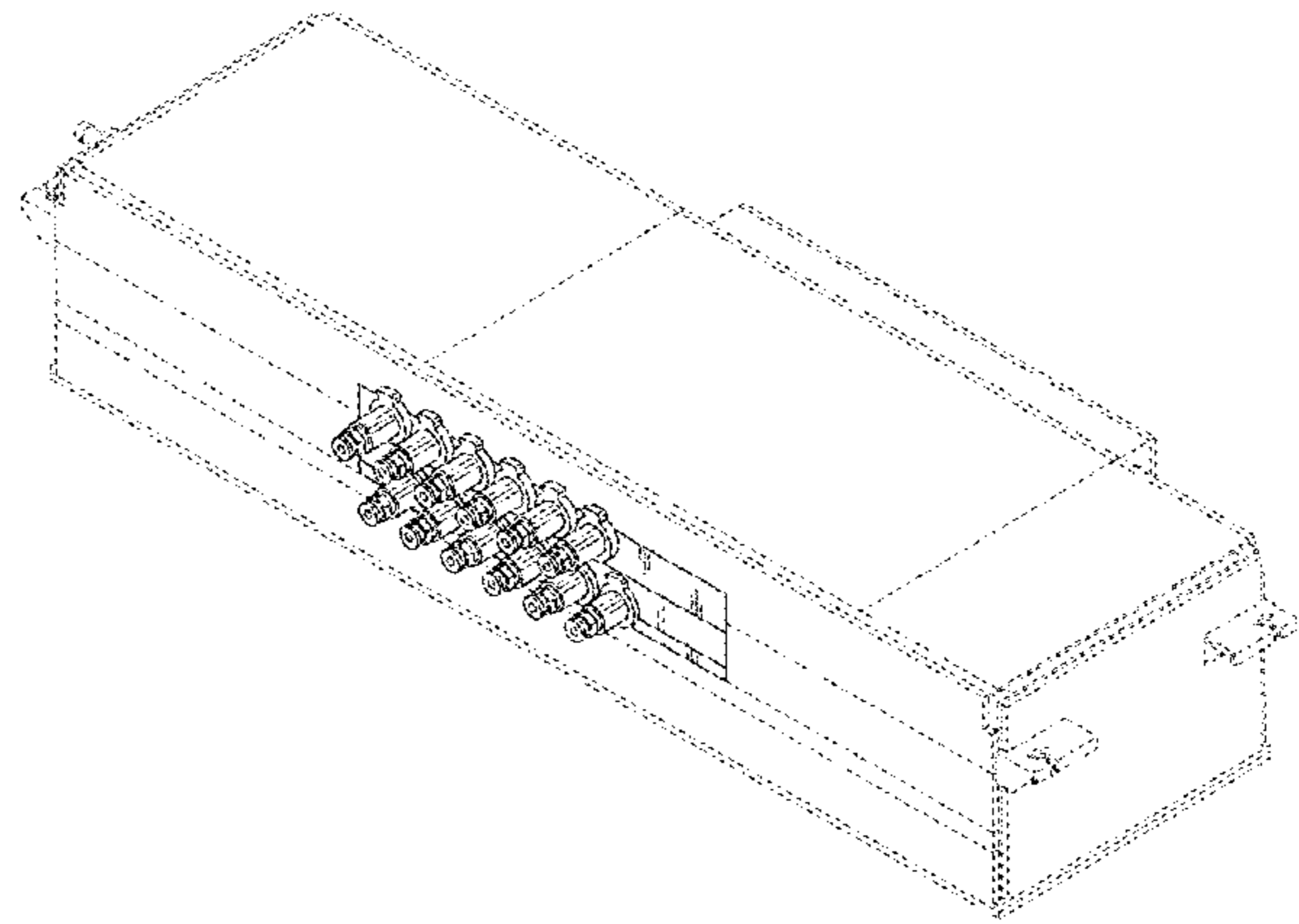
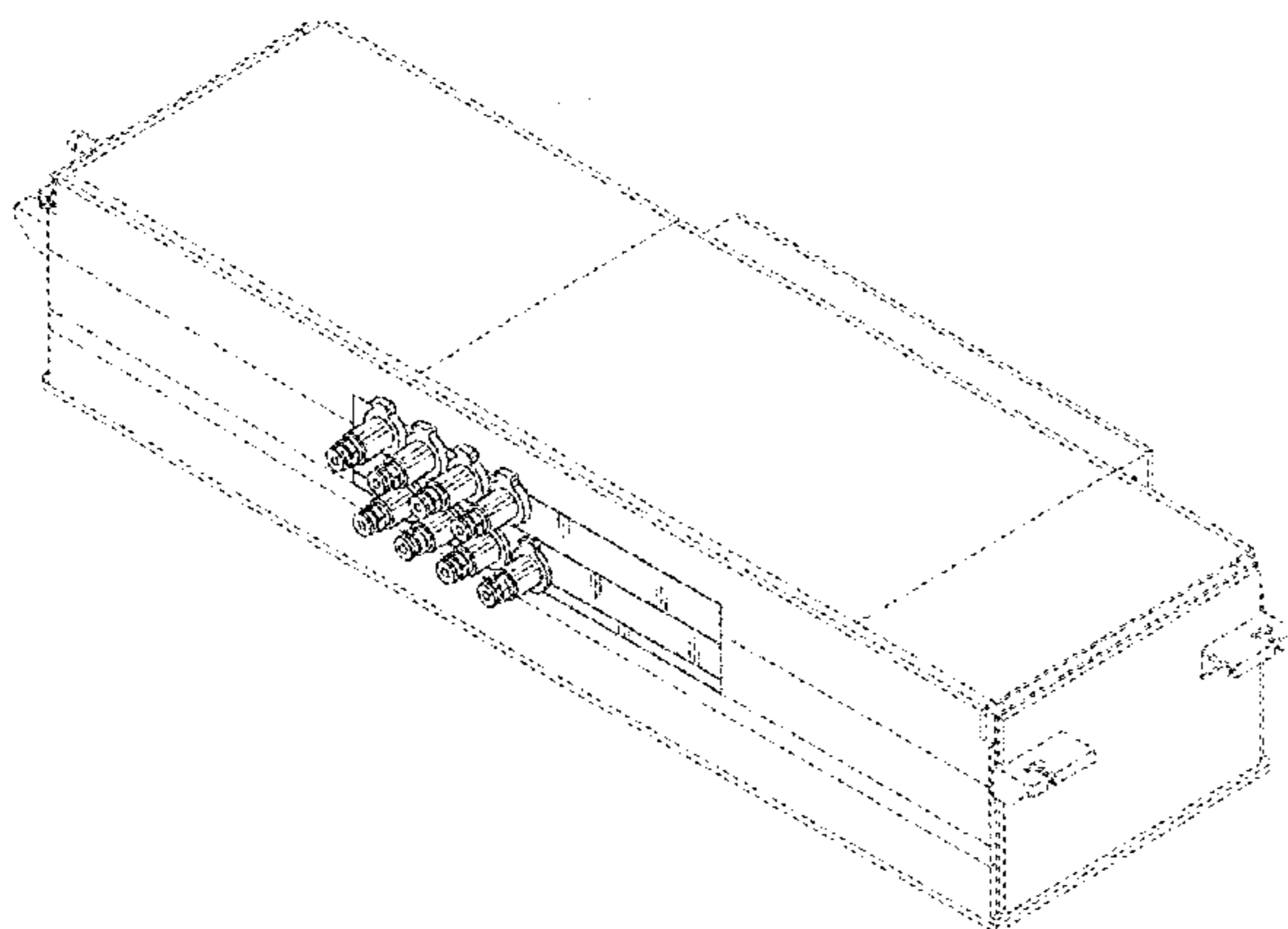

(56)

**References Cited**

U.S. PATENT DOCUMENTS

D405,092 S *	2/1999	Ohshima et al. ....	D14/239	D607,414 S *	1/2010	Egan et al. ....	D13/151
D412,489 S *	8/1999	Middlehurst et al. ....	D13/147	D613,251 S *	4/2010	Walker et al. ....	D13/147
D421,965 S *	3/2000	Johnston et al. ....	D13/147	D616,376 S *	5/2010	Lannoch ....	D13/162
D460,418 S *	7/2002	Han ....	D13/147	7,710,733 B2 *	5/2010	Neumetzler et al. ....	361/728
6,790,080 B2 *	9/2004	Cannon ....	439/551	D639,249 S *	6/2011	Walker et al. ....	D13/154
D547,307 S *	7/2007	Ogren ....	D14/240	8,096,827 B2 *	1/2012	Kleinkorres ....	439/540.1
D607,413 S *	1/2010	Egan et al. ....	D13/151	D673,914 S *	1/2013	Witkowski ....	D13/151
				D700,581 S *	3/2014	Shimamoto et al. ....	D13/147
				D700,896 S *	3/2014	Shimamoto et al. ....	D13/159
				2014/0301003 A1 *	10/2014	Jankowski ....	361/57

\* cited by examiner

Fig. 1

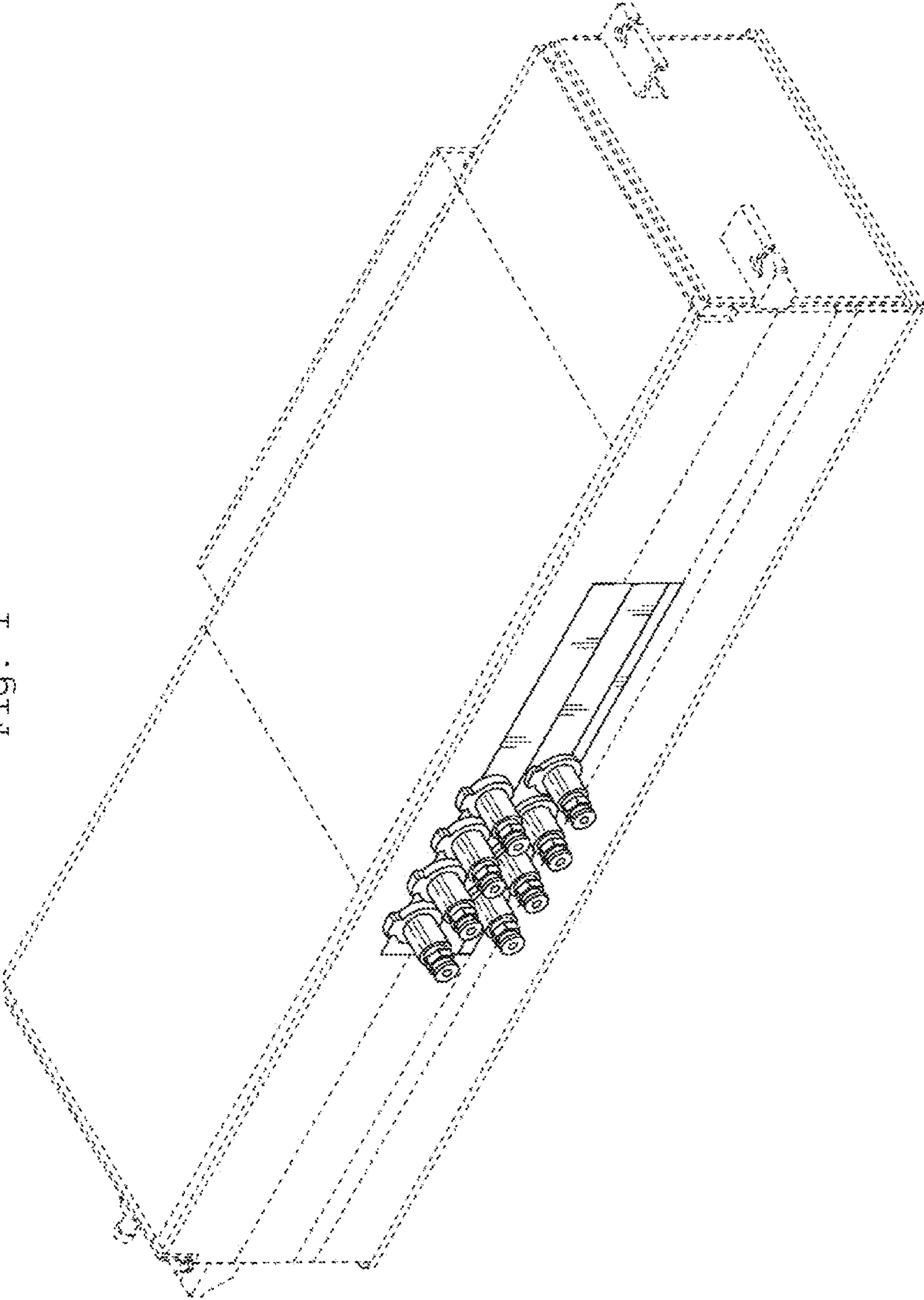

Fig. 2

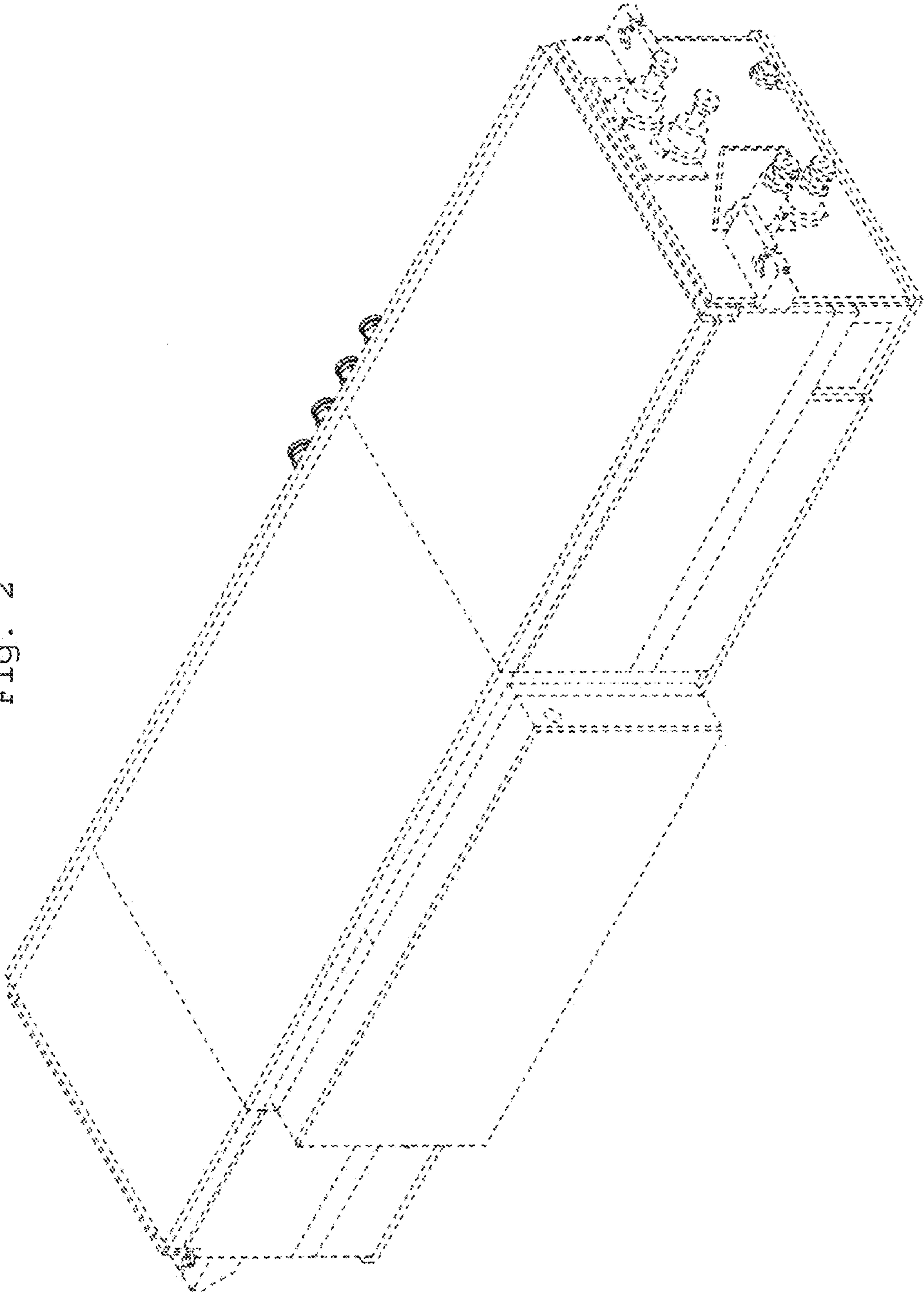



Fig. 3

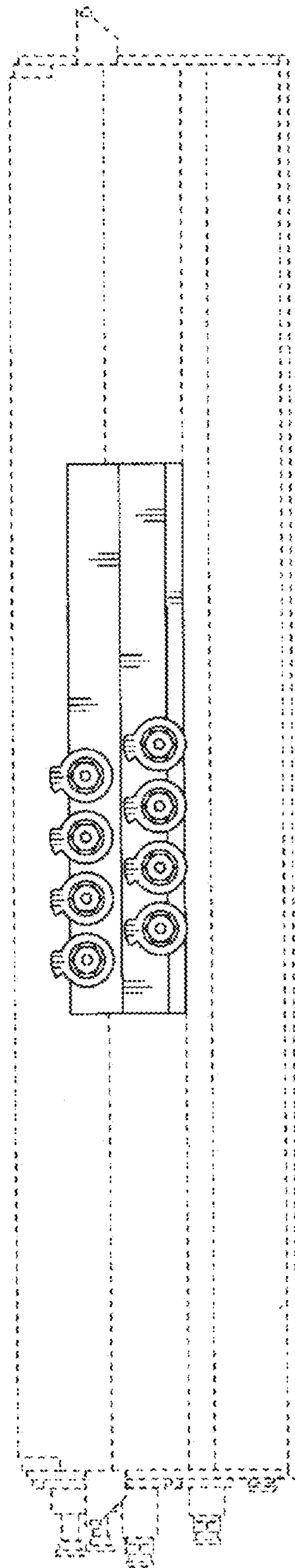

Fig. 4

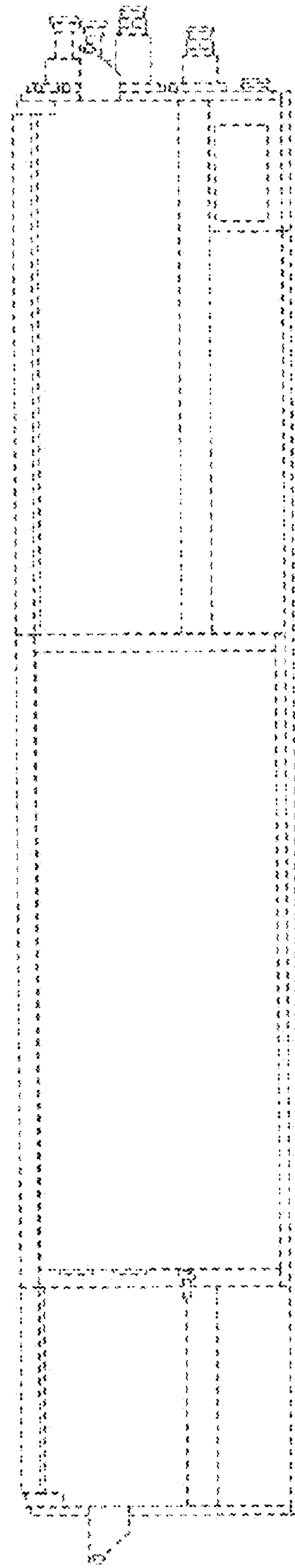

Fig. 6

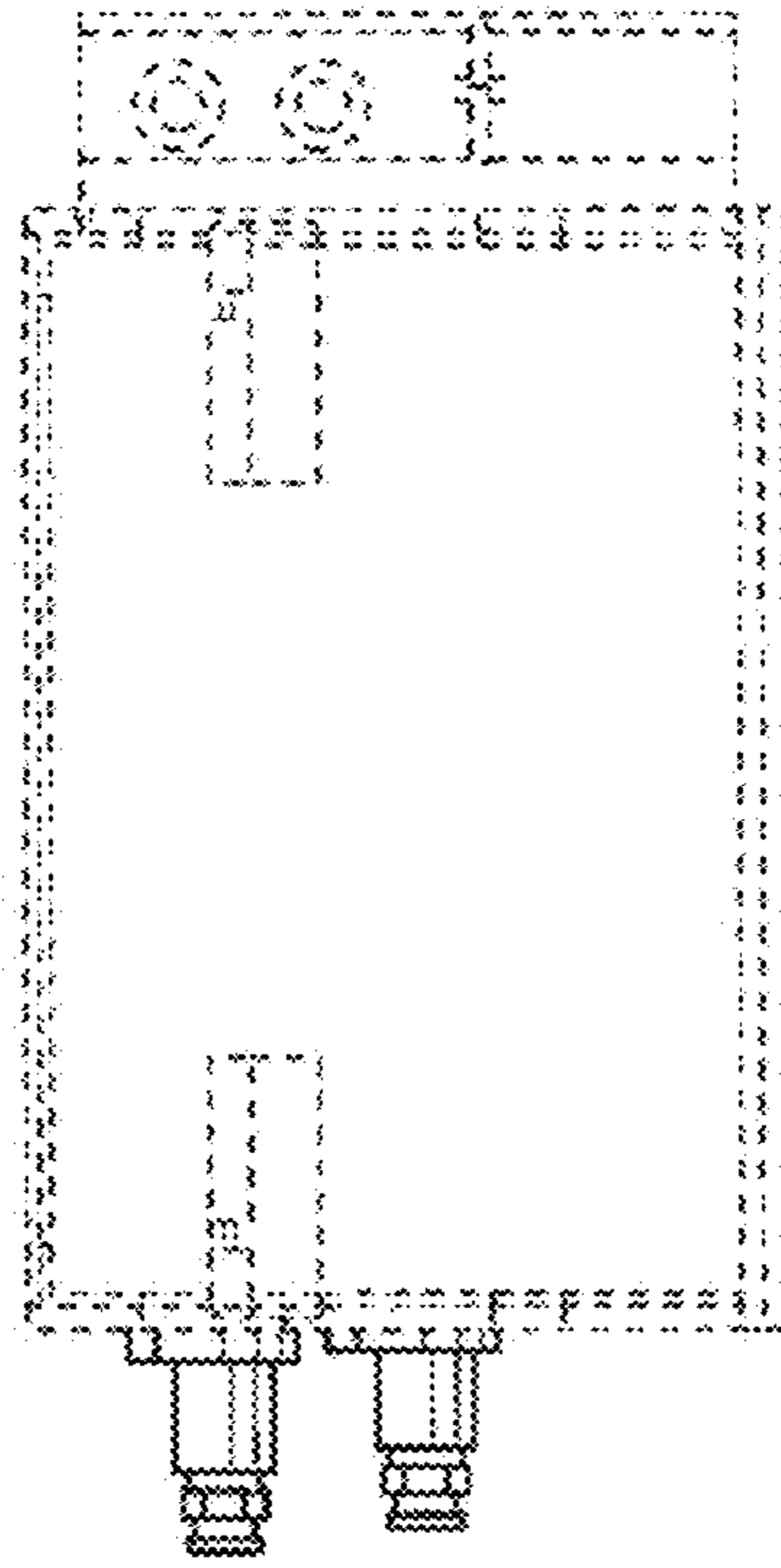

Fig. 5

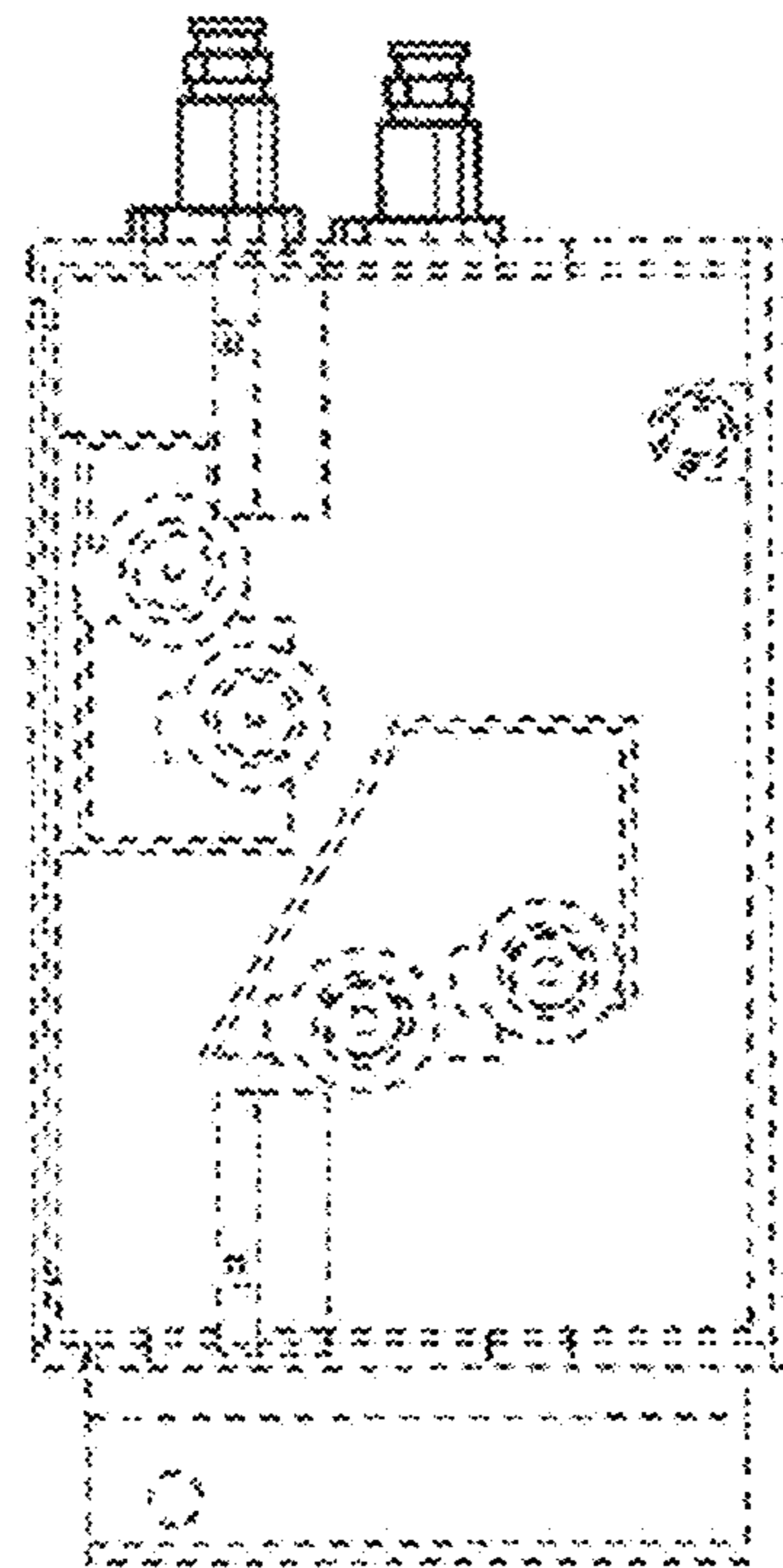

Fig. 7

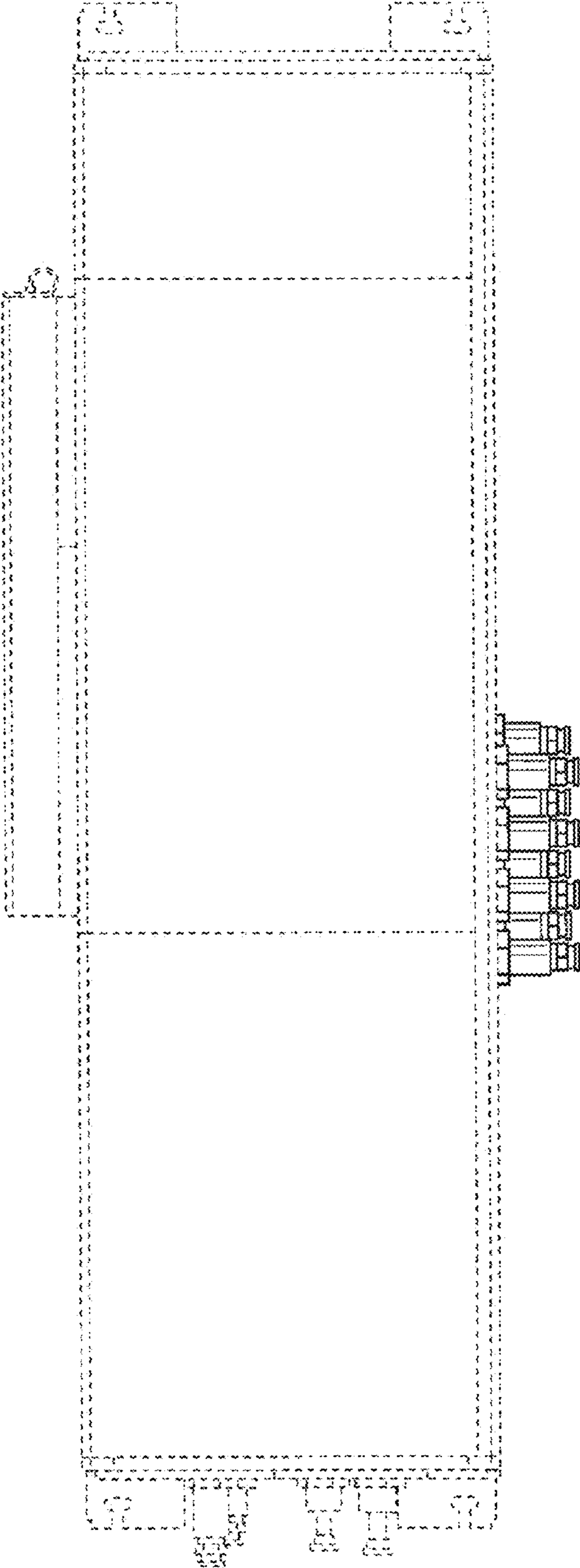

Fig. 8

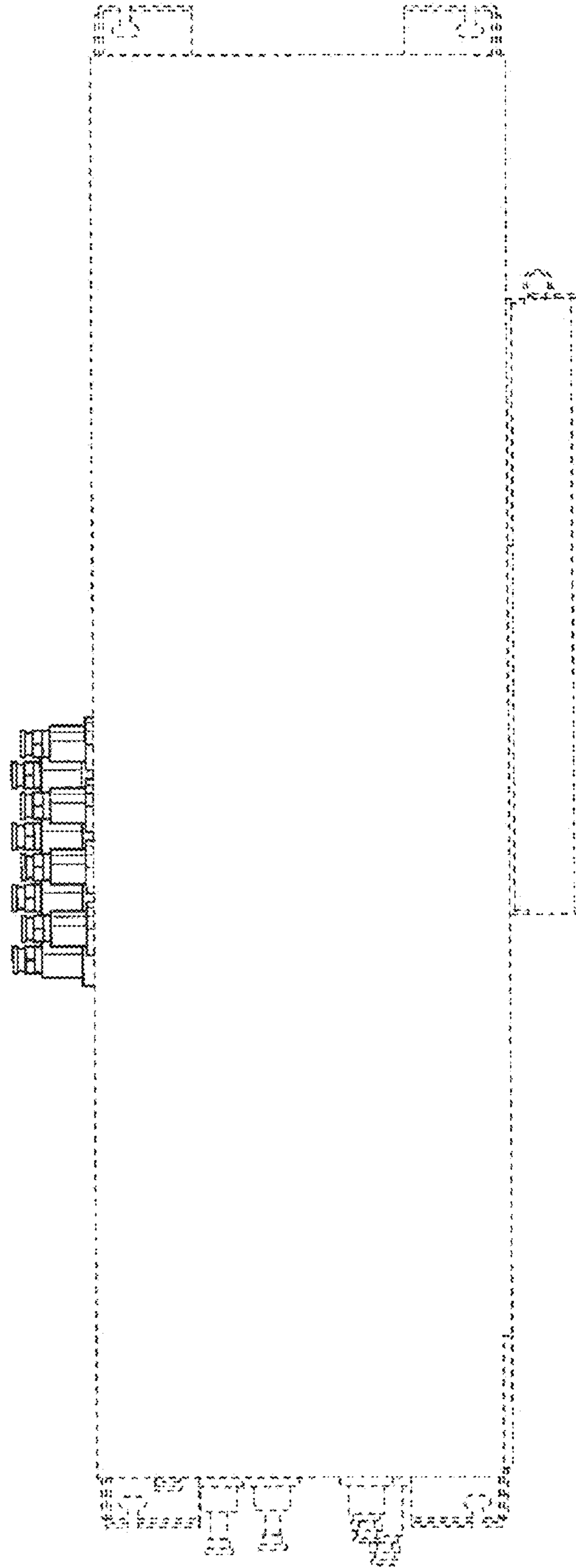



Fig. 9

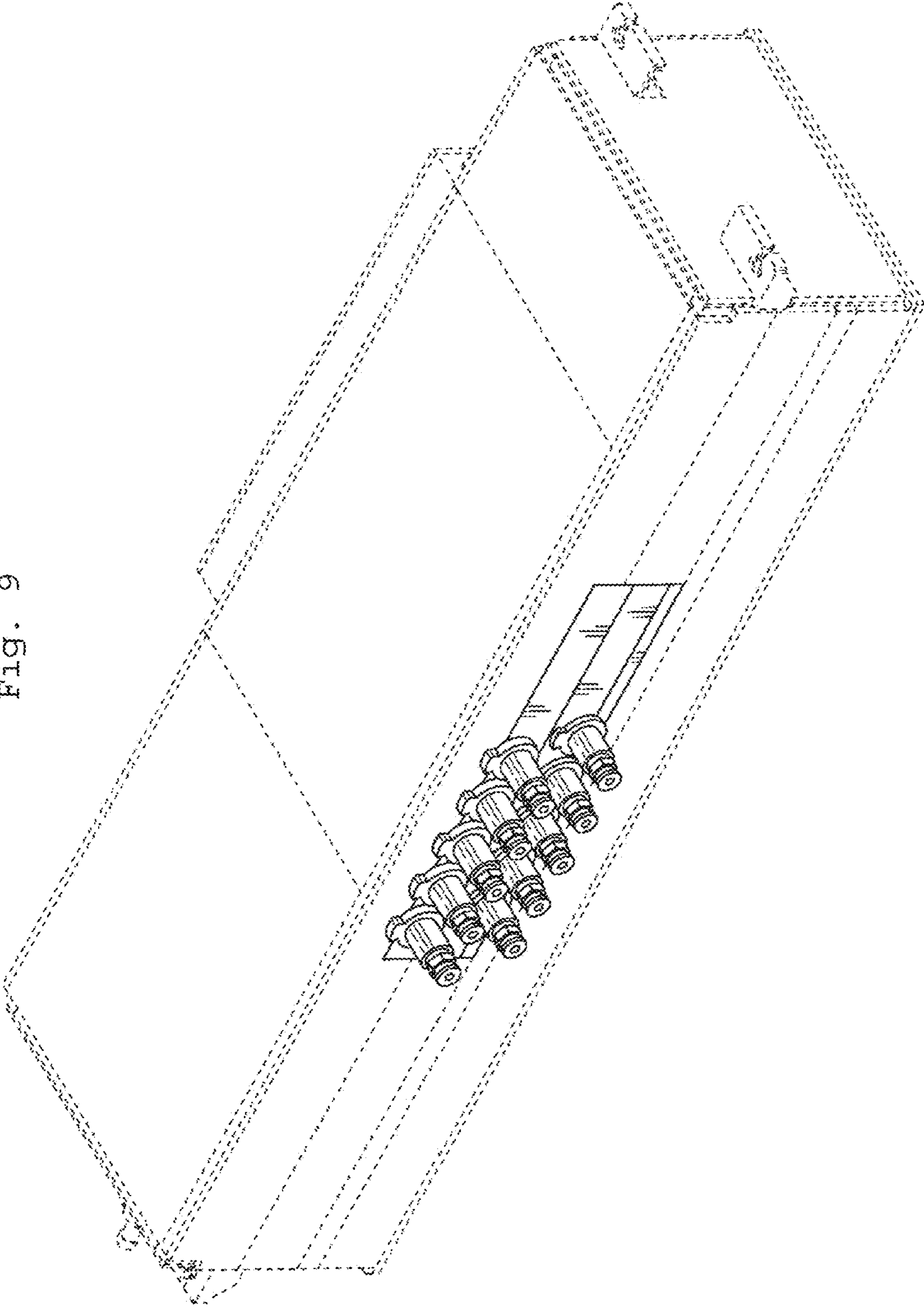

Fig. 10

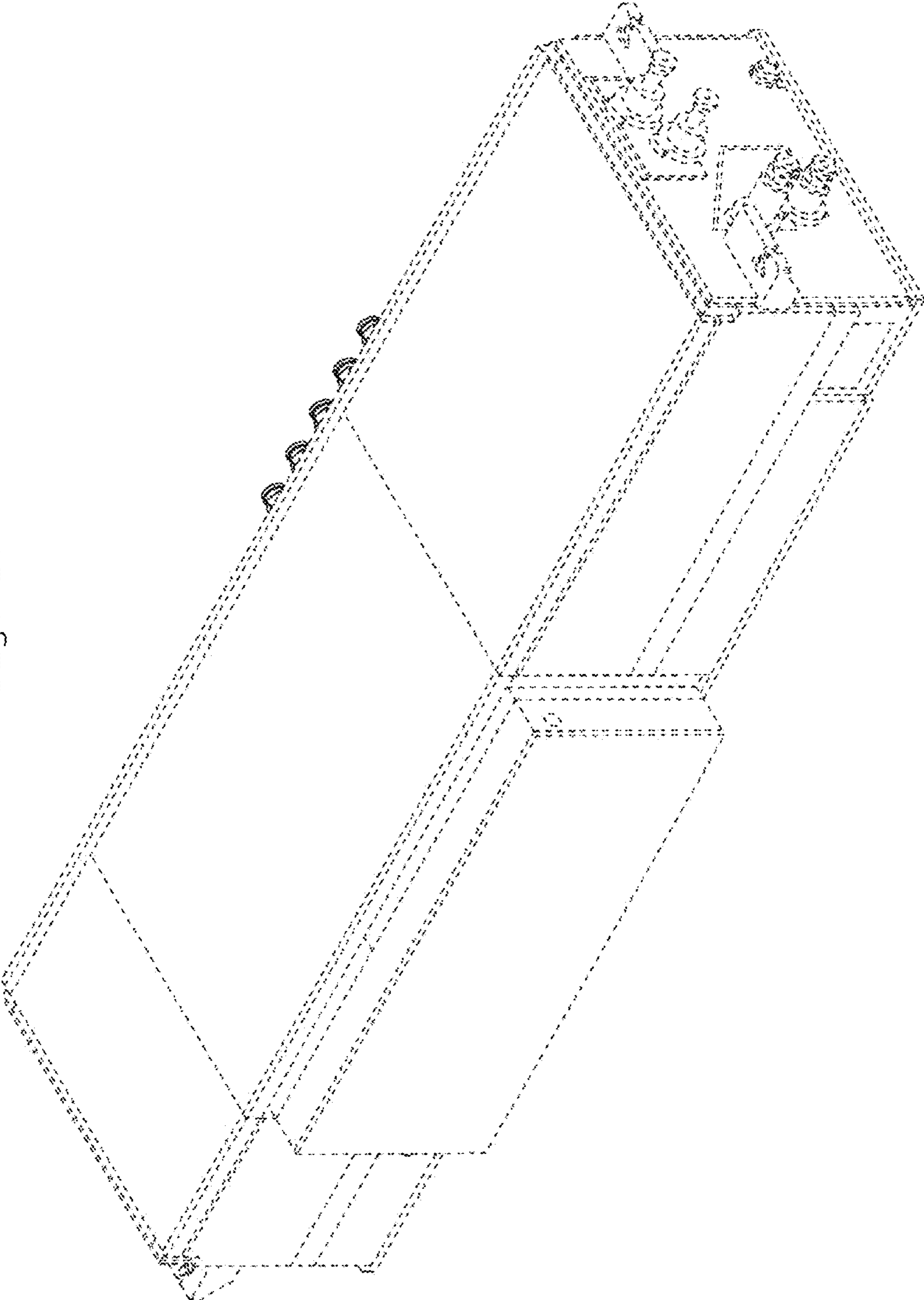

Fig. 11

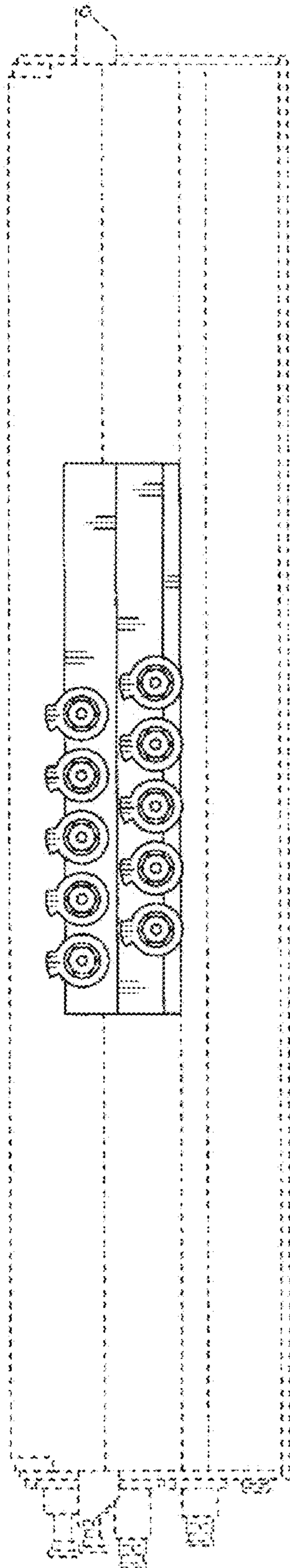

Fig. 12

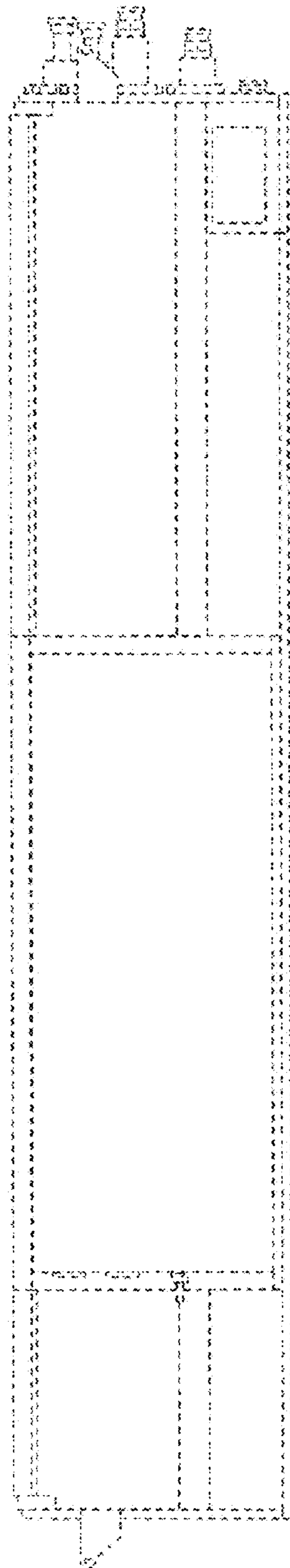

Fig. 14

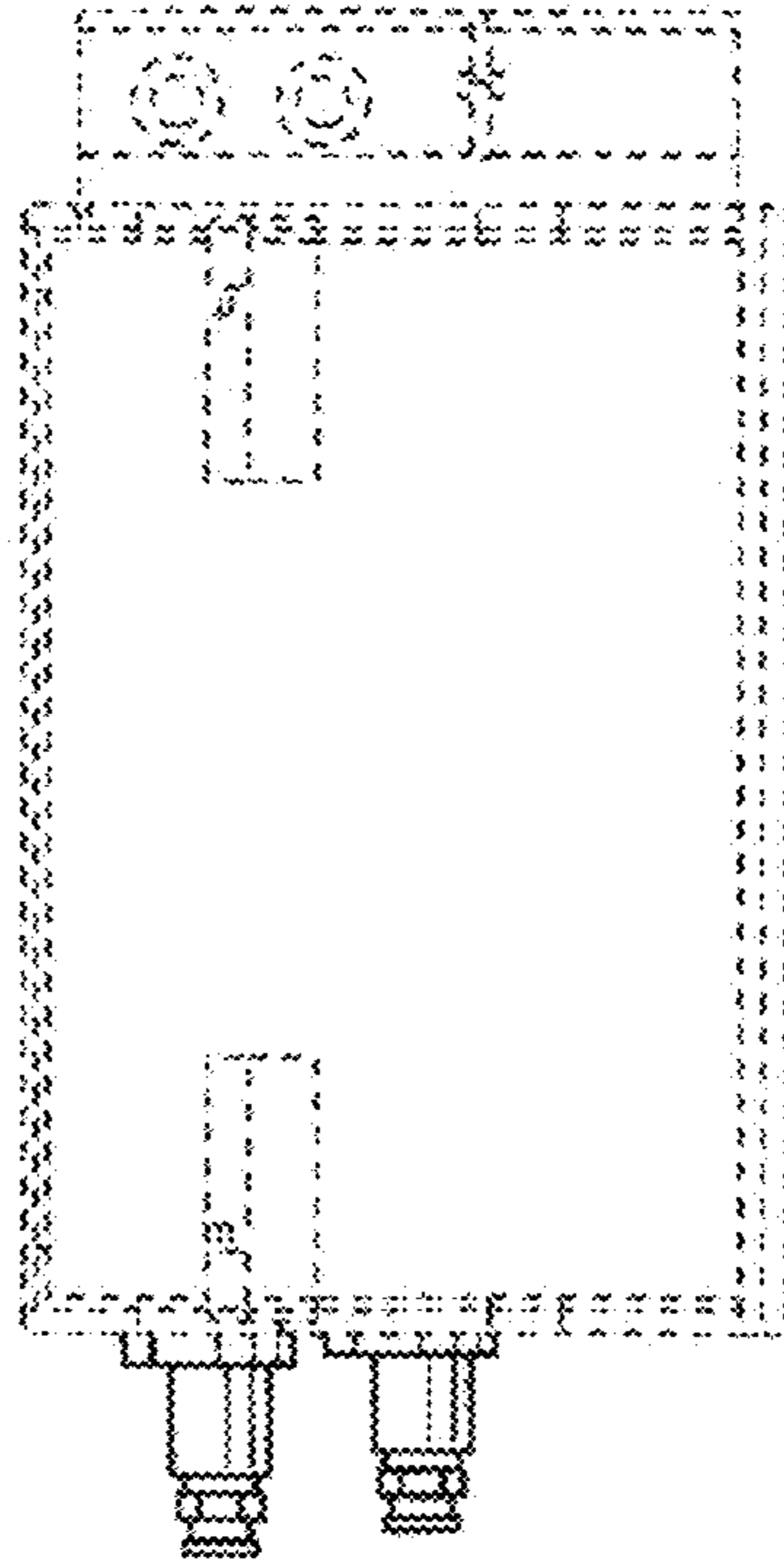

Fig. 13

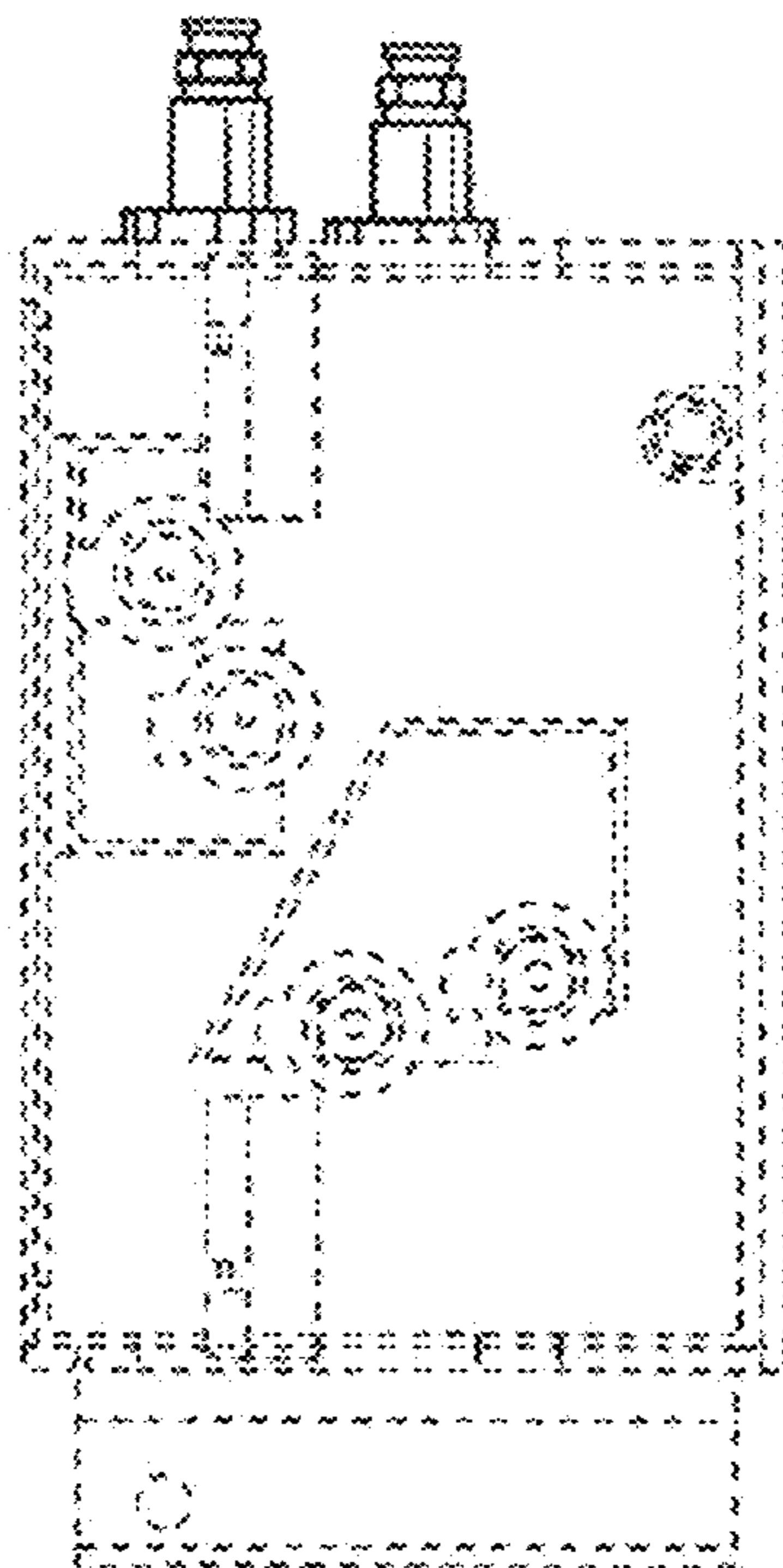



Fig. 15

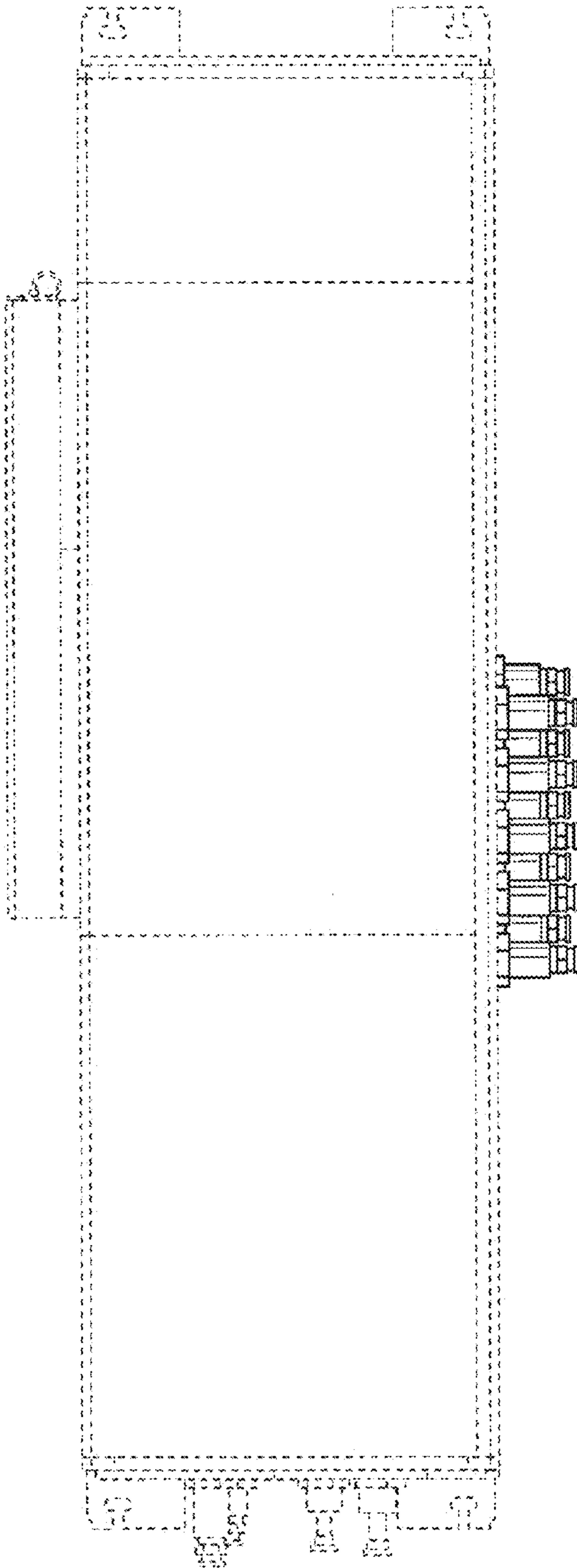

Fig. 16

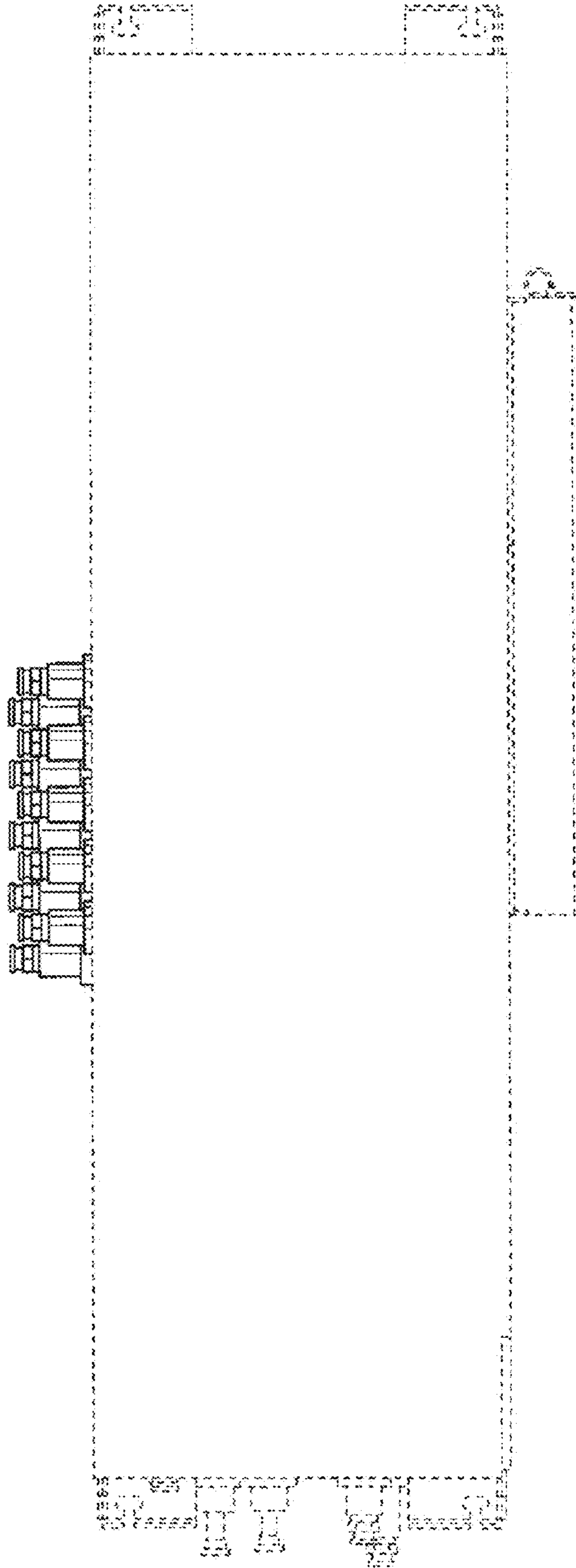

Fig. 17

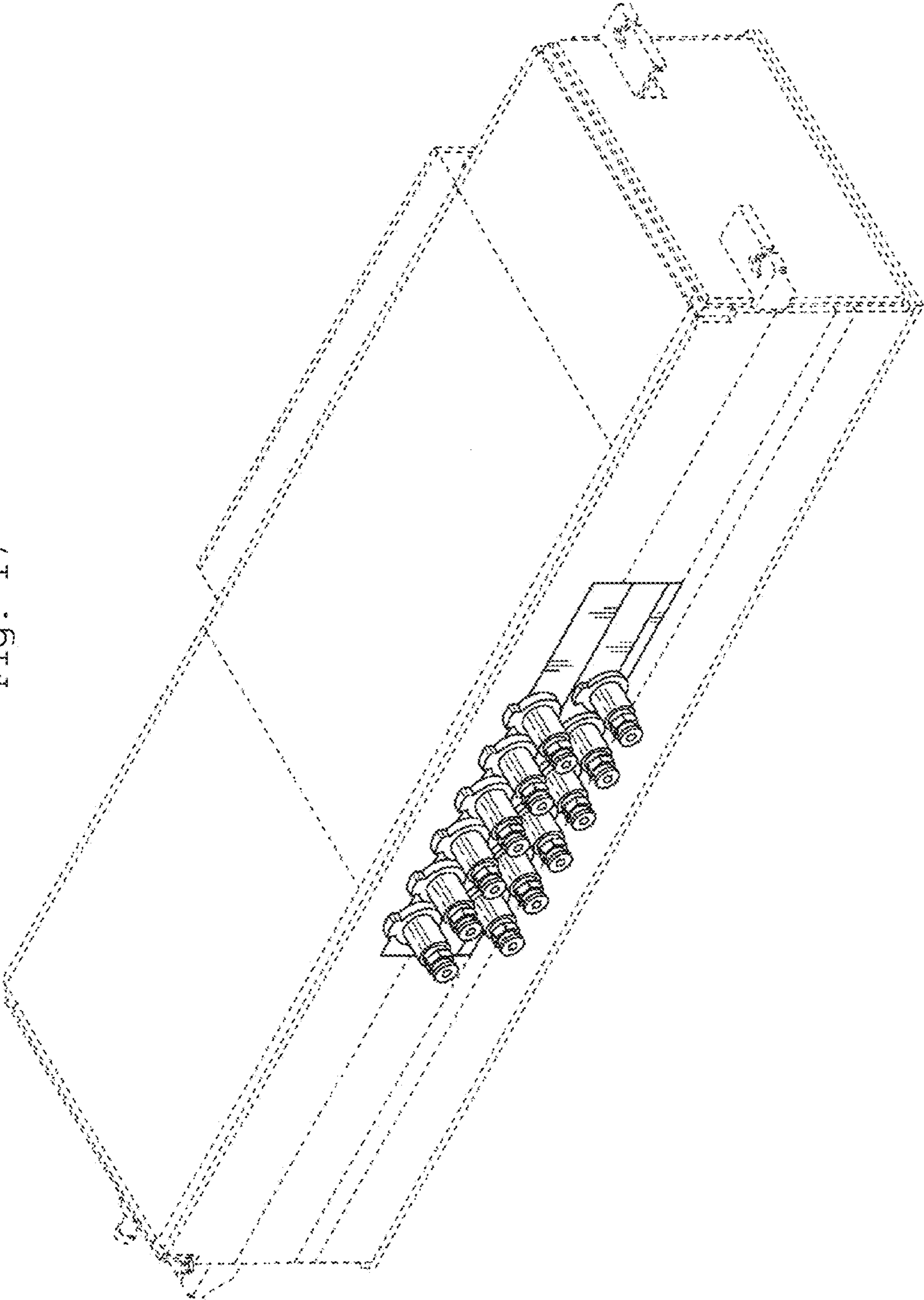

Fig. 18

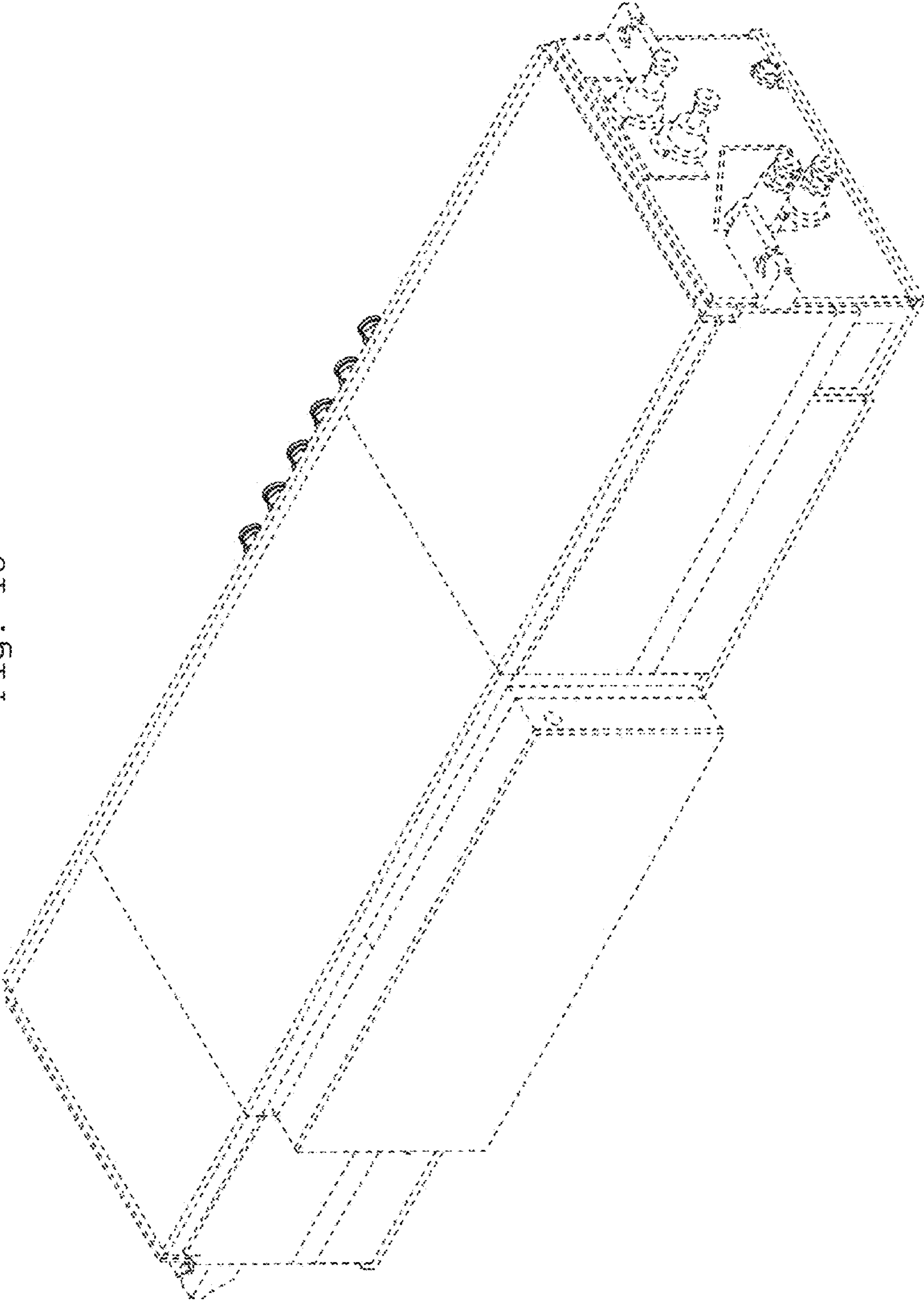



Fig. 19

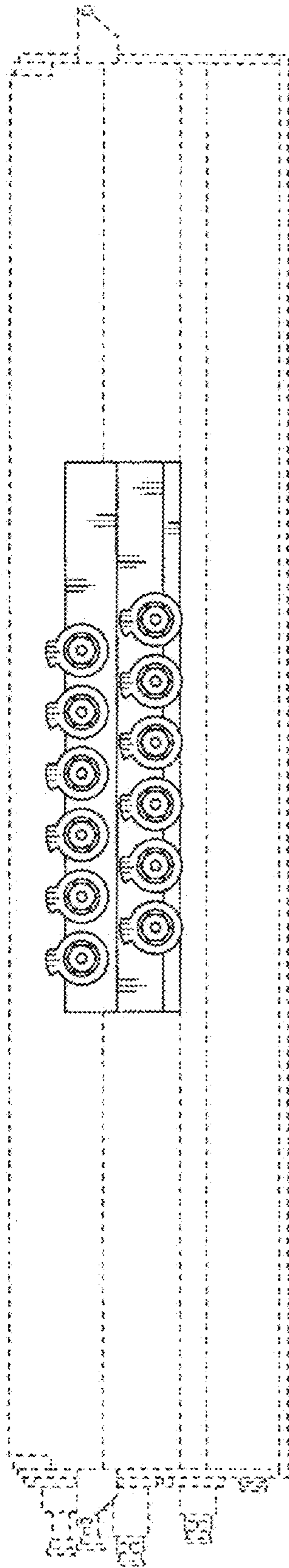

Fig. 20

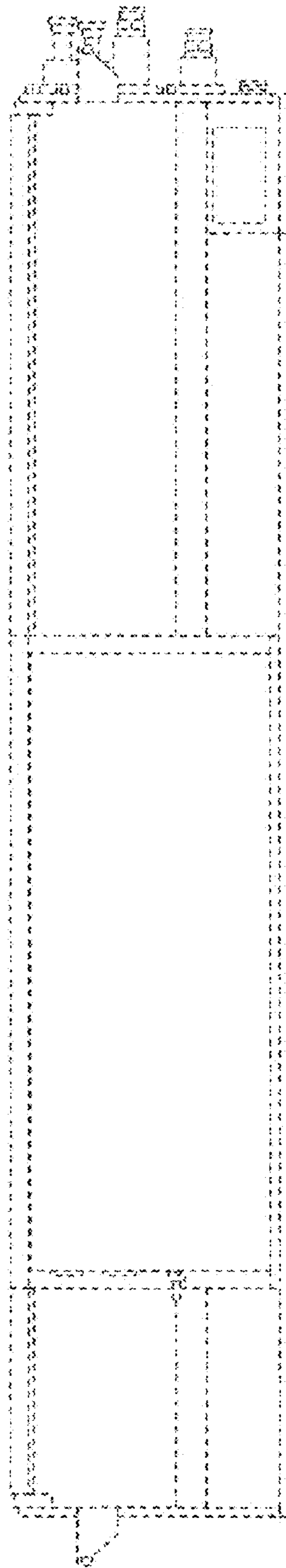

Fig. 22

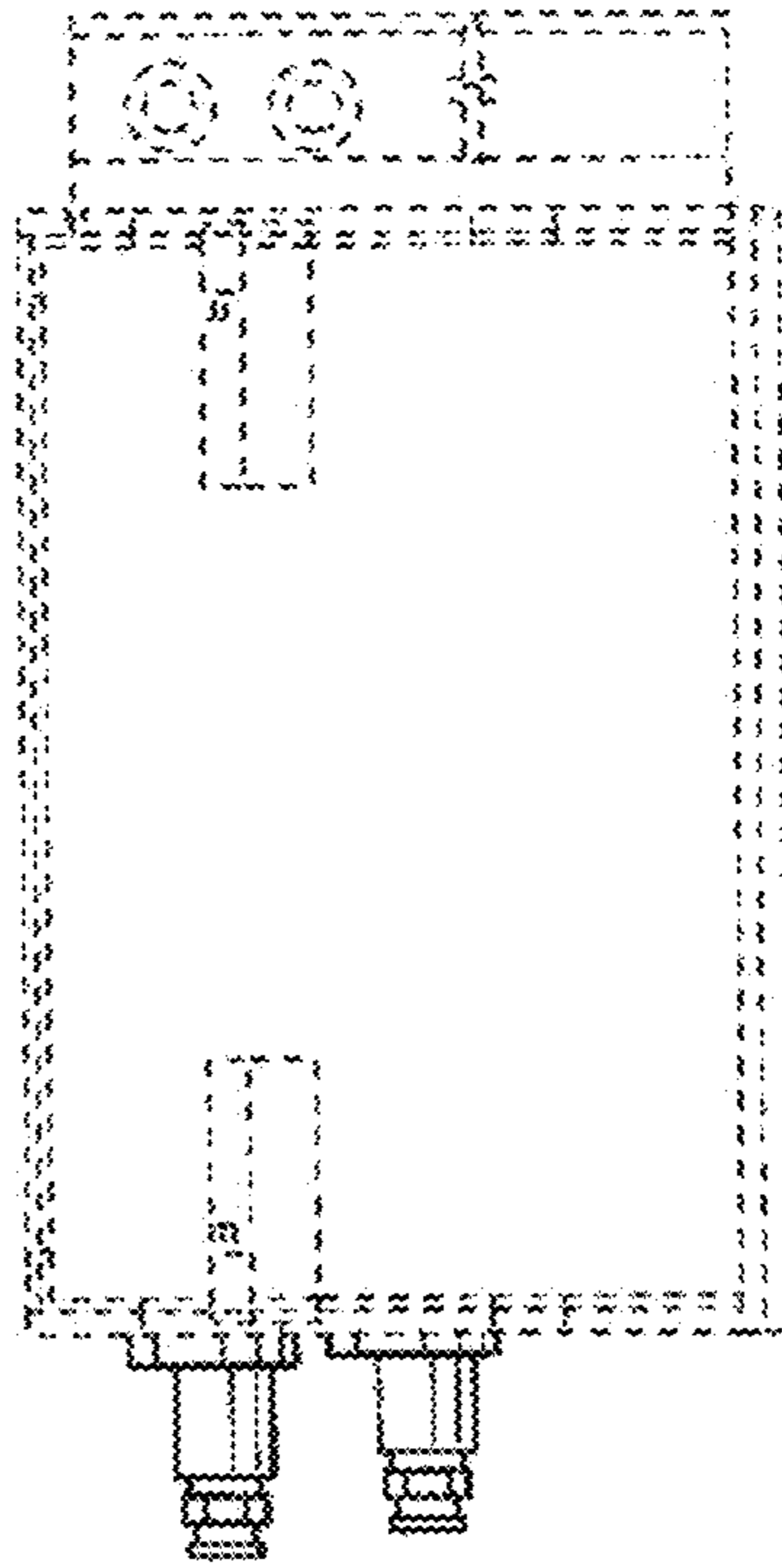

Fig. 21

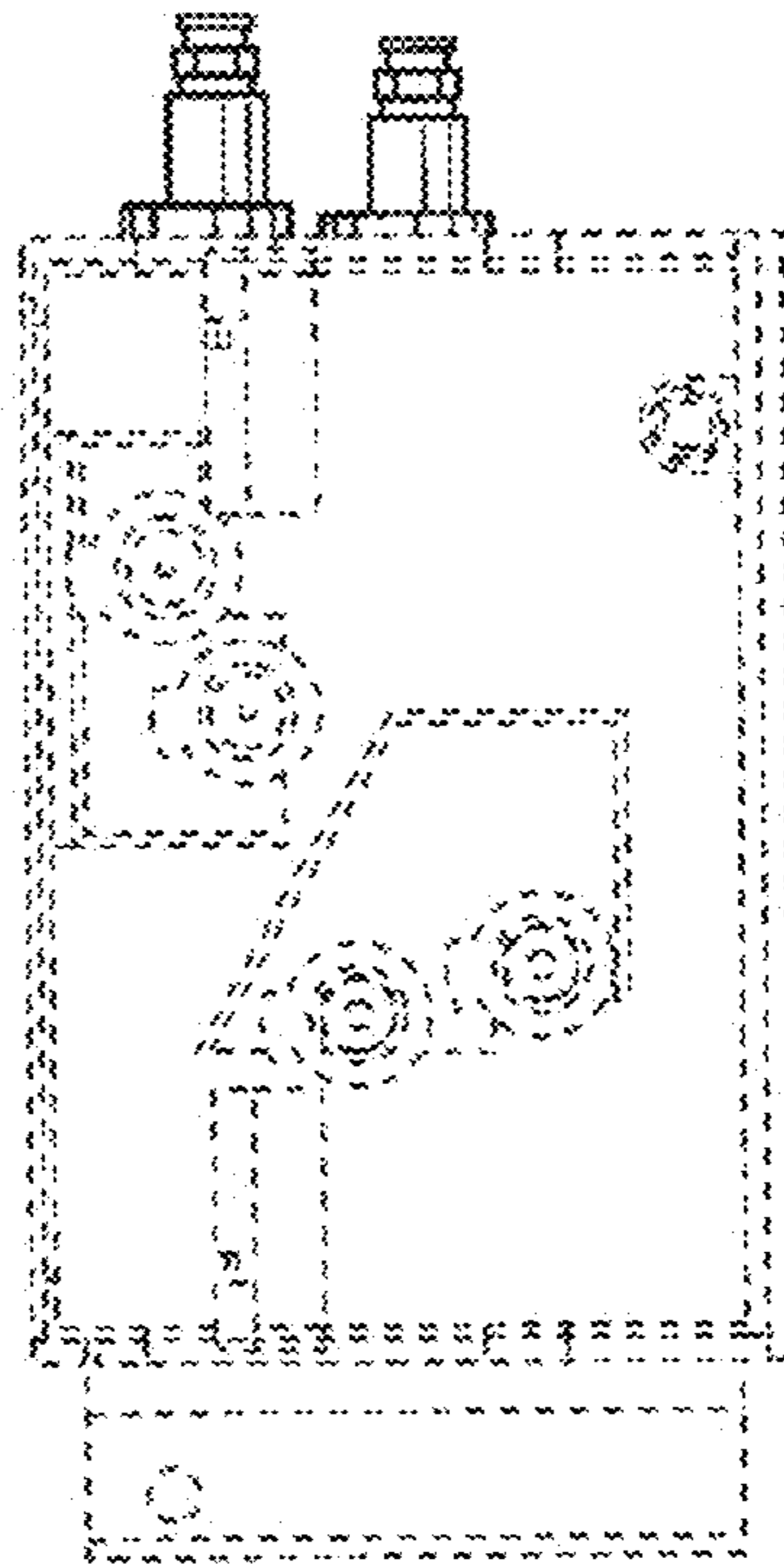

Fig. 23

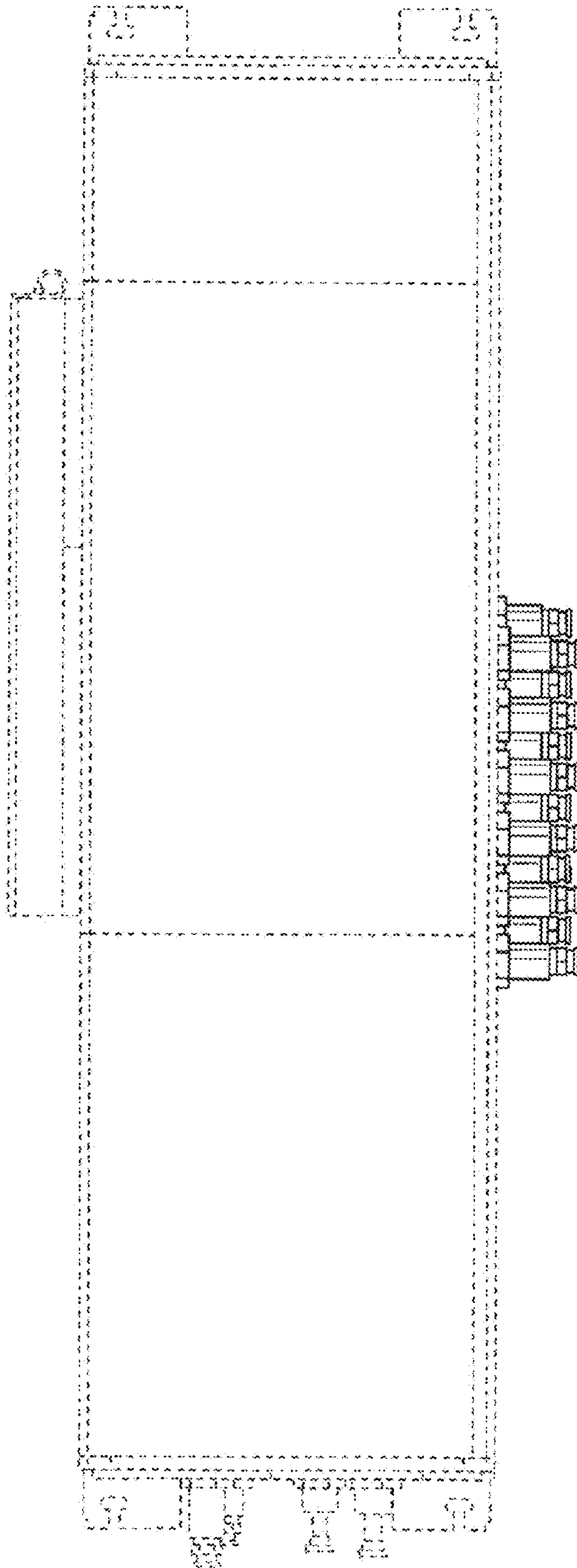

Fig. 24

