



US00D723968S

(12) **United States Design Patent**
Slimane

(10) **Patent No.:** **US D723,968 S**
(45) **Date of Patent:** **** Mar. 10, 2015**

(54) **RING**

D334,001 S * 3/1993 Muse D11/30
D370,427 S * 6/1996 Razza D11/31
D640,583 S * 6/2011 Kevan D11/33

(71) Applicant: **Yves Saint Laurent**, Paris (FR)

(72) Inventor: **Hedi Slimane**, West Hollywood, CA
(US)

(73) Assignee: **Yves Saint Laurent**, Paris (FR)

(**) Term: **14 Years**

(21) Appl. No.: **29/498,656**

(22) Filed: **Aug. 6, 2014**

(51) **LOC (10) Cl.** **11-01**

(52) **U.S. Cl.**
USPC **D11/26**

(58) **Field of Classification Search**
USPC D11/2, 26-39; 63/15, 15.1-15.4, 15.45,
63/15.5, 15.6, 15.7, 15.8, 15.9, 40
See application file for complete search history.

(56) **References Cited**

U.S. PATENT DOCUMENTS

D16,126 S * 6/1885 Huestis D11/35
D85,403 S * 10/1931 Swanson D11/2
2,584,087 A * 1/1952 Barbieri 63/1.12
D215,332 S * 9/1969 Libby D11/2
D241,062 S * 8/1976 Poulin D11/26
D327,861 S * 7/1992 Davis D11/26

OTHER PUBLICATIONS

[Online] http://www.ysl.com/us/shop-product/women/jewelry-rings-cherry-ring-in-sterling-silver_cod50157516io.html#dept=rings_jewels_women_. Retrieved Nov. 6, 2014.*
[Online] http://cdn.styloko.com/images/35341985_435x435.jpg. Retrieved Nov. 6, 2014.*

* cited by examiner

Primary Examiner — Garth Rademaker

Assistant Examiner — Melanie Pellegrini

(74) *Attorney, Agent, or Firm* — Donald J. Ranft; Kristen A. Mogavero

(57) **CLAIM**

The ornamental design for a ring, as shown.

DESCRIPTION

FIG. 1 is a top perspective view of a ring showing my new design;

FIG. 2 is a bottom perspective view thereof;

FIG. 3 is a front view thereof;

FIG. 4 is a side view thereof;

FIG. 5 is a top view thereof; and,

FIG. 6 is a bottom view thereof.

1 Claim, 3 Drawing Sheets

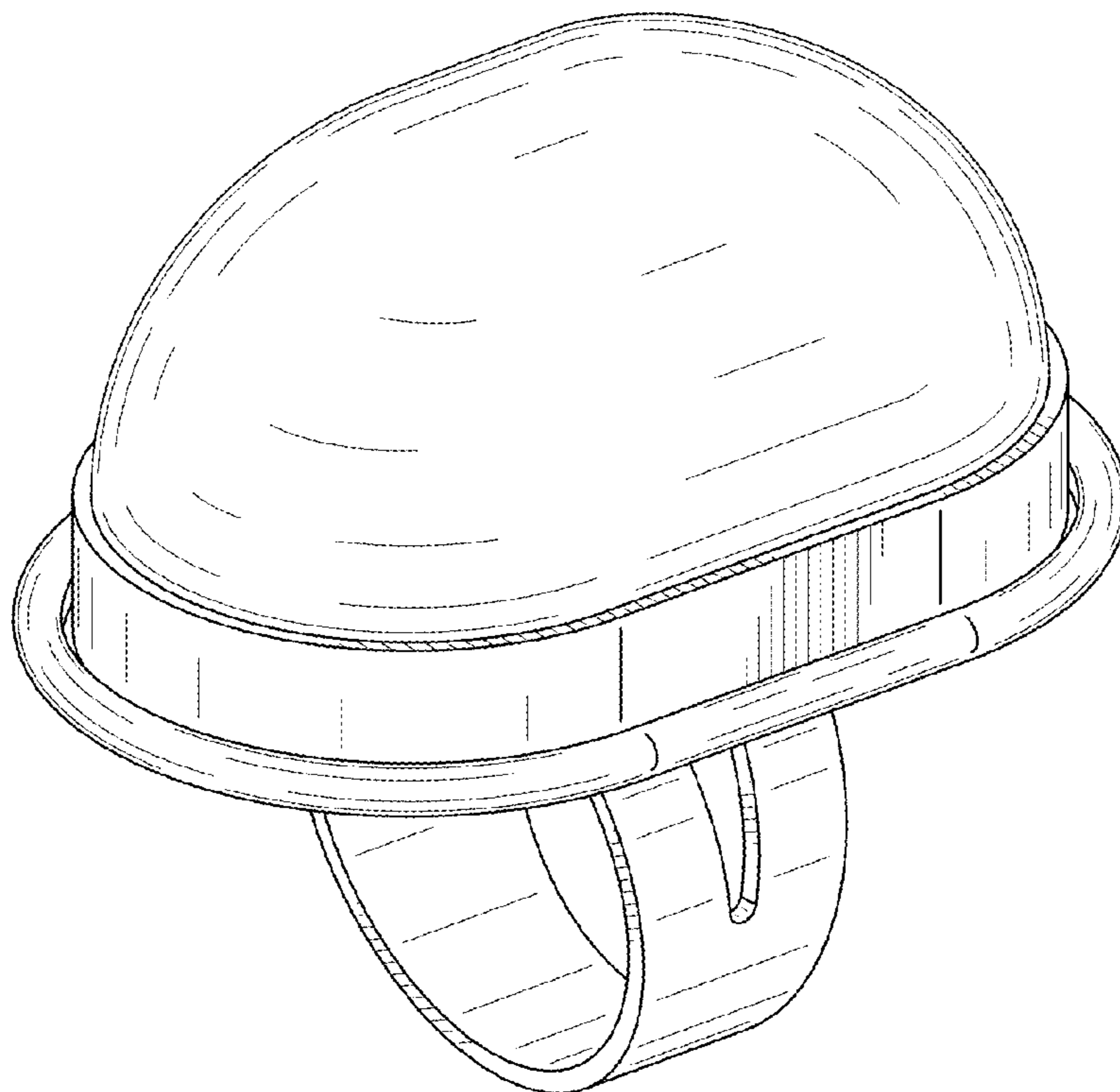

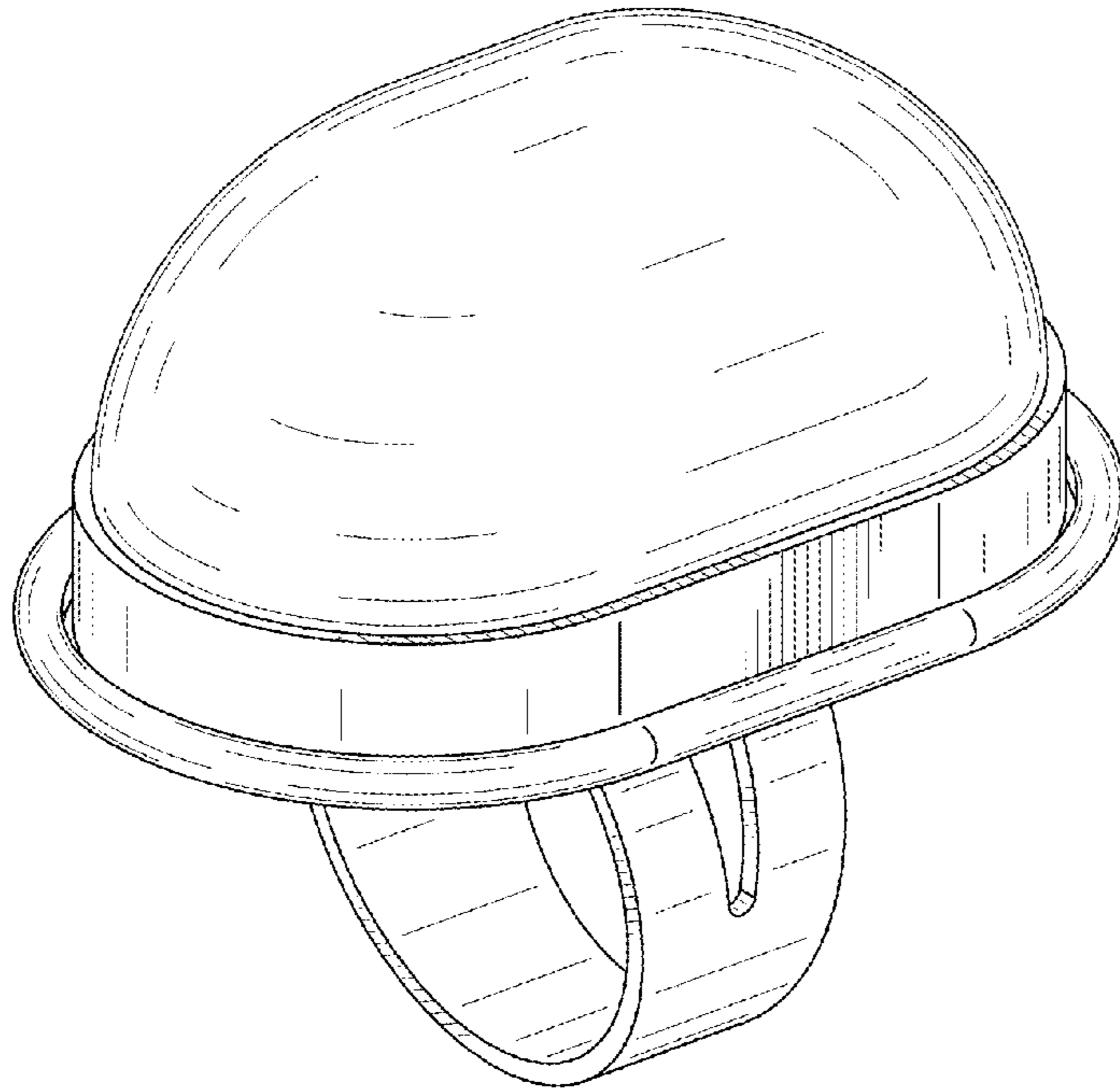

FIG. 1

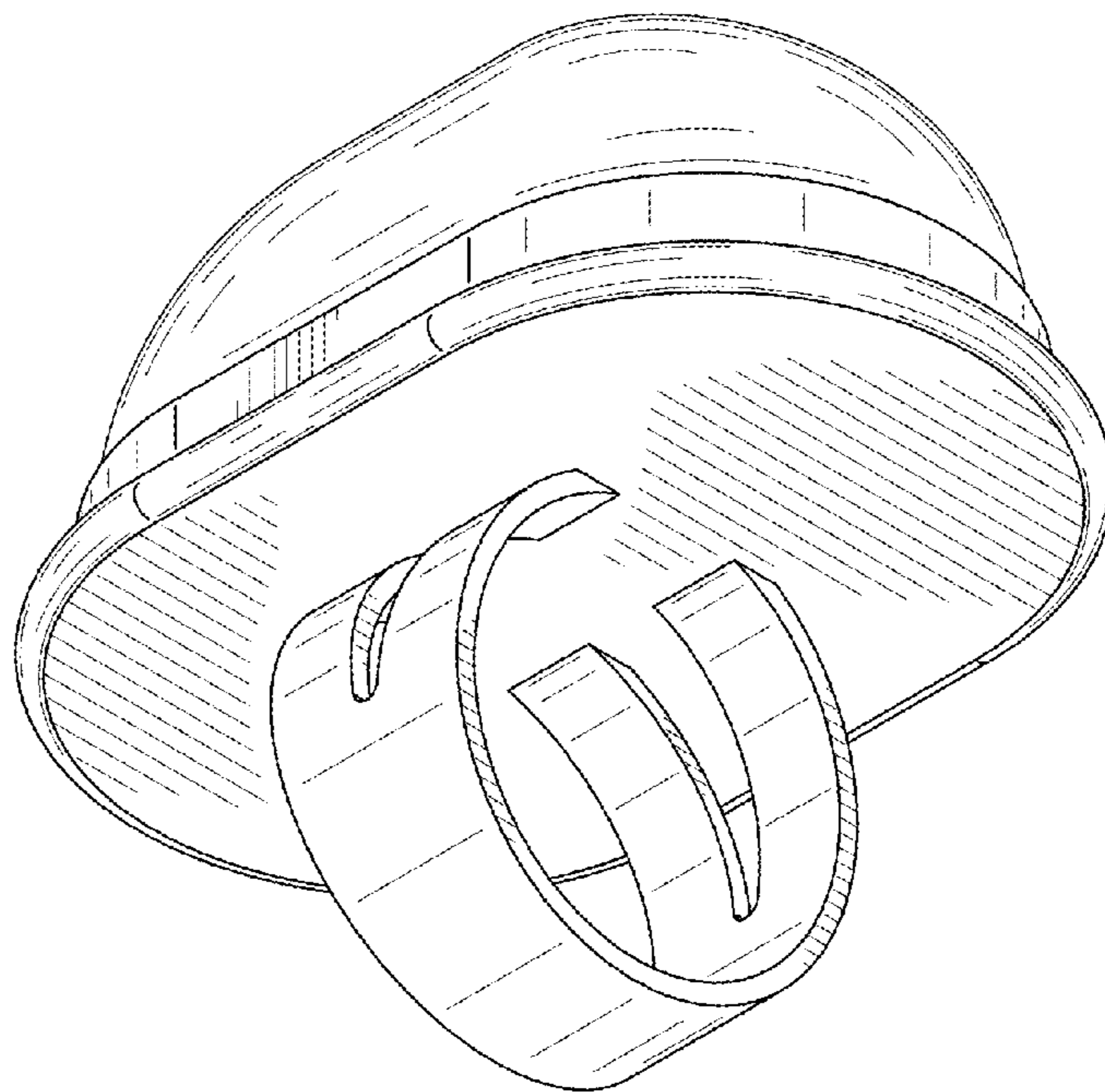

FIG. 2

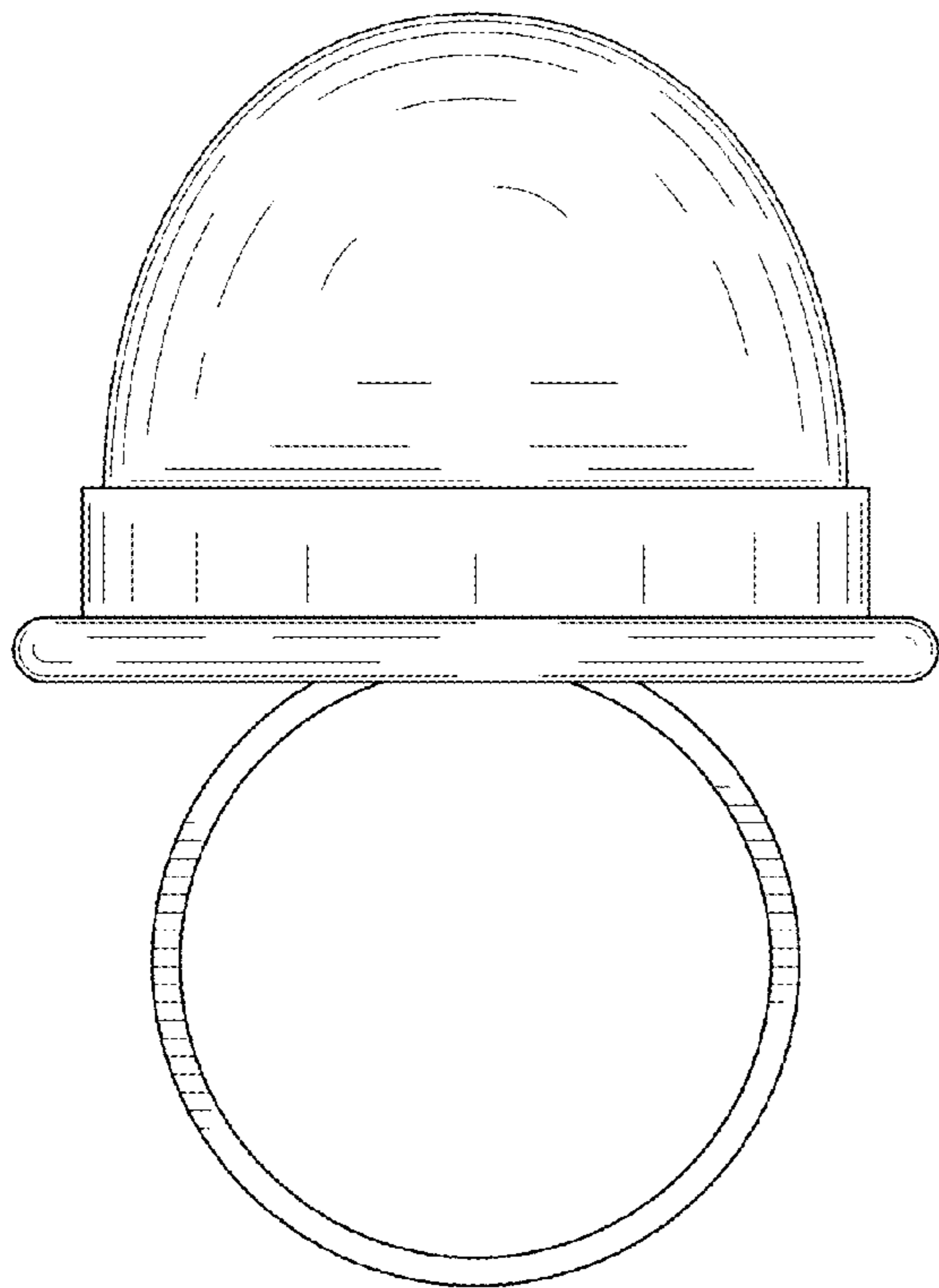

FIG. 3

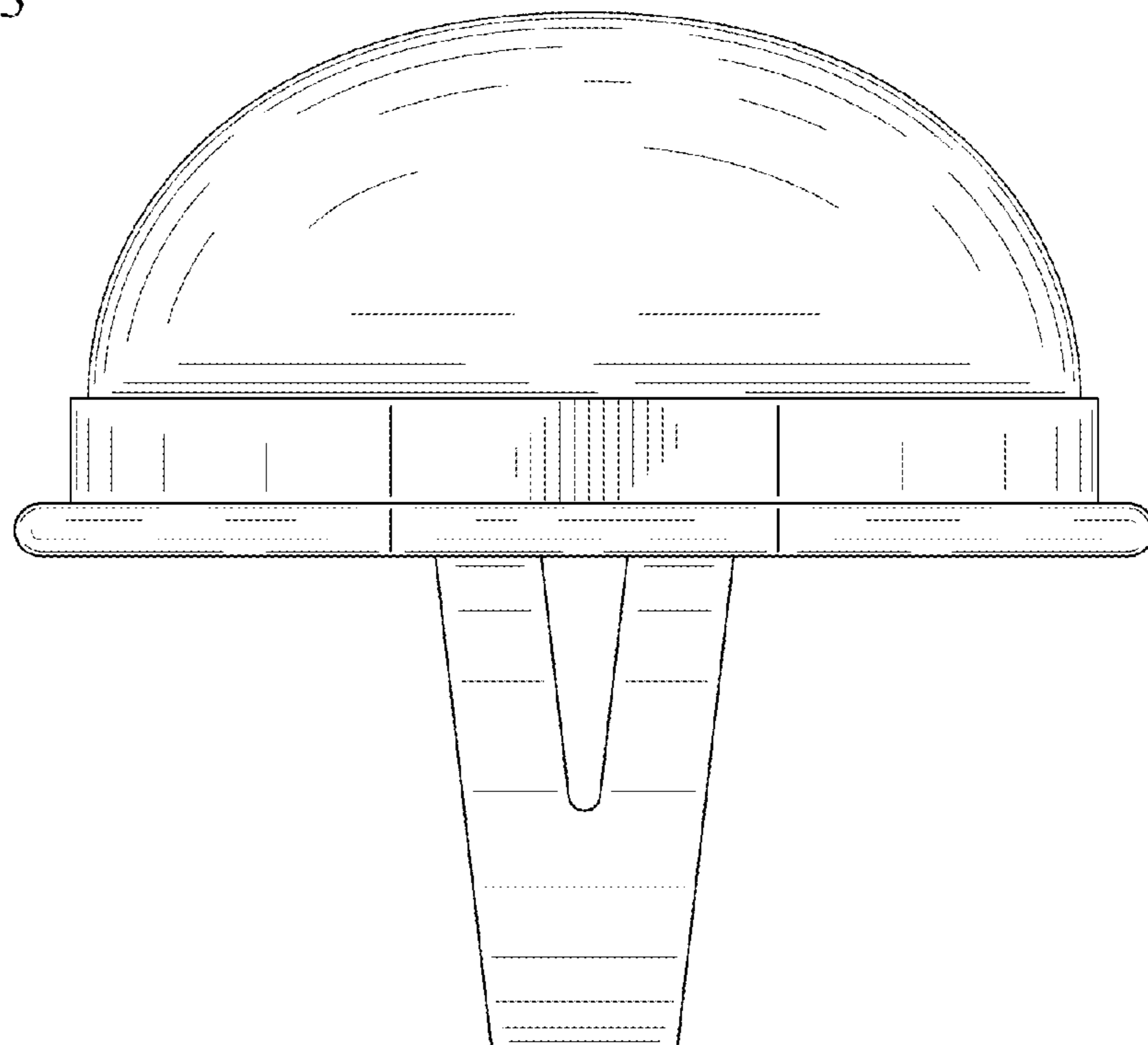

FIG. 4

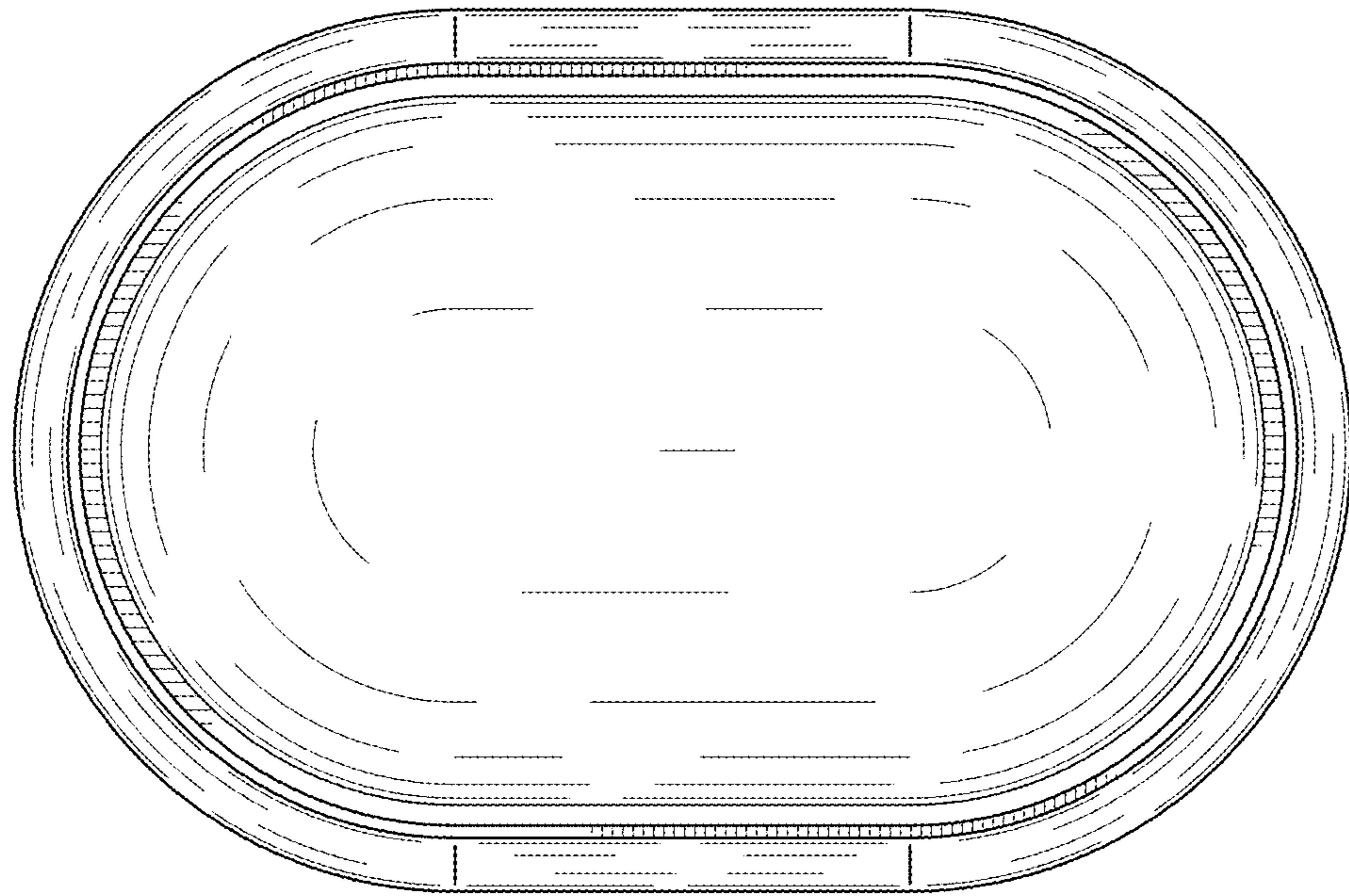

FIG. 5

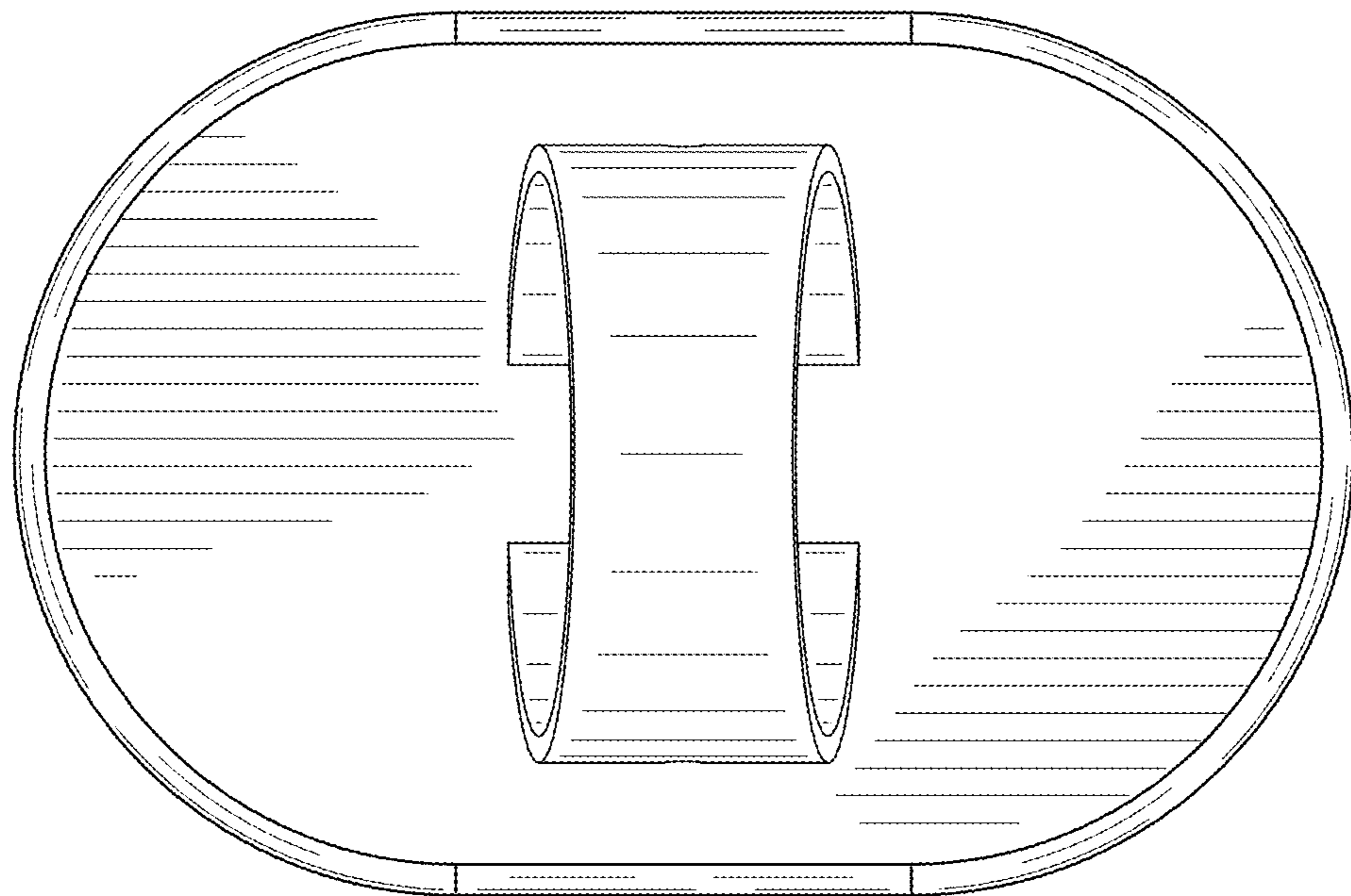

FIG. 6