



US00D723964S

(12) **United States Design Patent**
Monachon

(10) **Patent No.:** **US D723,964 S**
(45) **Date of Patent:** **** Mar. 10, 2015**

- (54) **DIAL**
- (71) Applicant: **Omega Ltd.**, Biel/Bienne (CH)
- (72) Inventor: **Jean-Claude Monachon**, Bevaix (CH)
- (73) Assignee: **Omega Ltd.**, Biel/Bienne (CH)
- (**) Term: **14 Years**
- (21) Appl. No.: **29/496,787**
- (22) Filed: **Jul. 17, 2014**

D695,144 S *	12/2013	Calvani	D10/126
D702,567 S *	4/2014	Monachon	D10/32
D703,552 S *	4/2014	Monachon	D10/32
D703,555 S *	4/2014	Monachon	D10/32
D706,143 S *	6/2014	Monachon	D10/32
D709,784 S *	7/2014	Stegmann et al.	D10/126
D709,785 S *	7/2014	Stegmann	D10/126
D712,770 S *	9/2014	Stegmann et al.	D10/126

* cited by examiner

Primary Examiner — Lucy Lieberman

(74) *Attorney, Agent, or Firm* — Donald J. Ranft; Kristen A. Mogavero; Collen IP

- (30) **Foreign Application Priority Data**
Jan. 17, 2014 (WO) DM/082 639
- (51) **LOC (10) Cl.** **10-07**
- (52) **U.S. Cl.**
USPC **D10/126**
- (58) **Field of Classification Search**
CPC G04B 19/06; G04B 19/08; G04B 19/10;
G04B 19/106
USPC D10/123–126, 30–39; 368/223, 228,
368/232, 28
See application file for complete search history.

(57) **CLAIM**
The ornamental design for a dial, as shown.

DESCRIPTION

FIG. 1 is a first embodiment of a top perspective view of a dial showing my new design;
 FIG. 2 is a bottom perspective view thereof;
 FIG. 3 is a top view thereof;
 FIG. 4 is a bottom view thereof;
 FIG. 5 is a left side view thereof;
 FIG. 6 is a right side view thereof;
 FIG. 7 is a front view thereof; and
 FIG. 8 is a rear view thereof.
 FIG. 9 is a top perspective view of a second embodiment of a dial showing my new design;
 FIG. 10 is a bottom perspective view thereof;
 FIG. 11 is a top view thereof;
 FIG. 12 is a bottom view thereof;
 FIG. 13 is a left side view thereof;
 FIG. 14 is a right side view thereof;
 FIG. 15 is a front view thereof; and,
 FIG. 16 is a rear view thereof.

- (56) **References Cited**
U.S. PATENT DOCUMENTS
D322,037 S * 12/1991 Takani D10/32
D324,829 S * 3/1992 Bock D10/126
6,404,704 B1 * 6/2002 Bossel et al. 368/232
D551,095 S * 9/2007 Monachon D10/32
D558,633 S * 1/2008 Wei D10/126
D580,796 S * 11/2008 Calvani D10/33
D617,662 S * 6/2010 Monachon D10/32
D674,710 S * 1/2013 Monachon D10/32
D693,719 S * 11/2013 Calvani D10/126
D694,144 S * 11/2013 Calvani D10/126

1 Claim, 8 Drawing Sheets

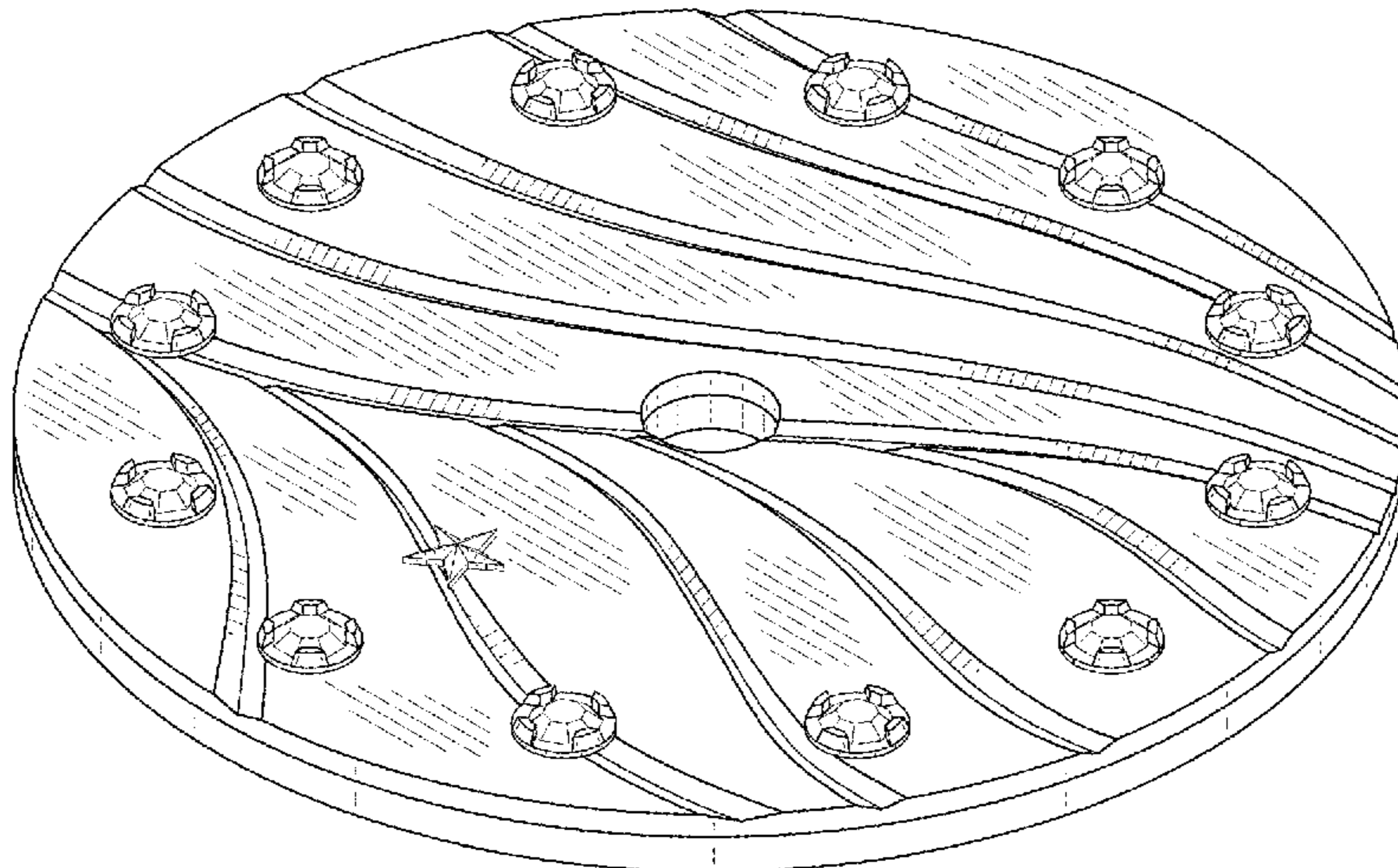

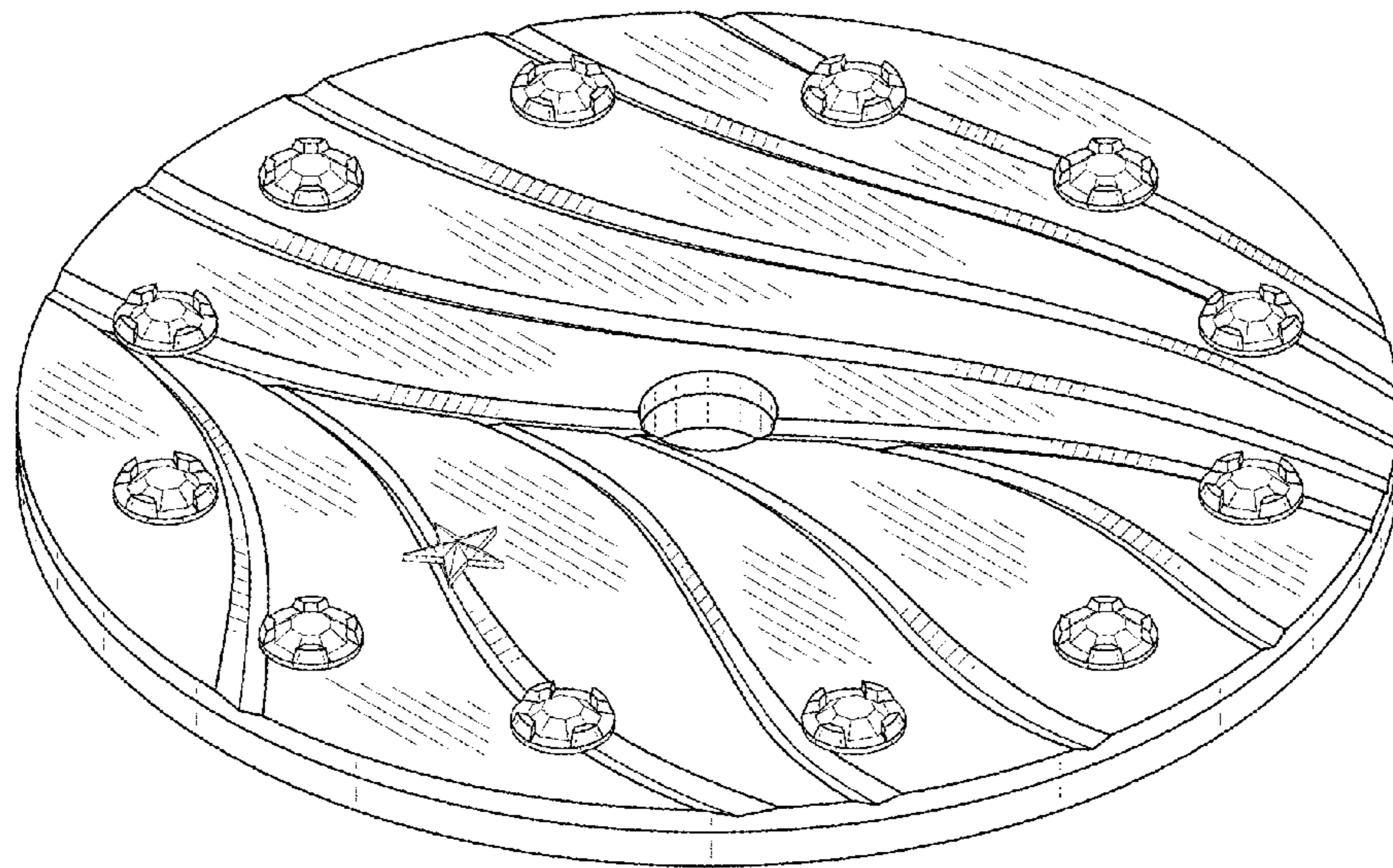

FIG. 1

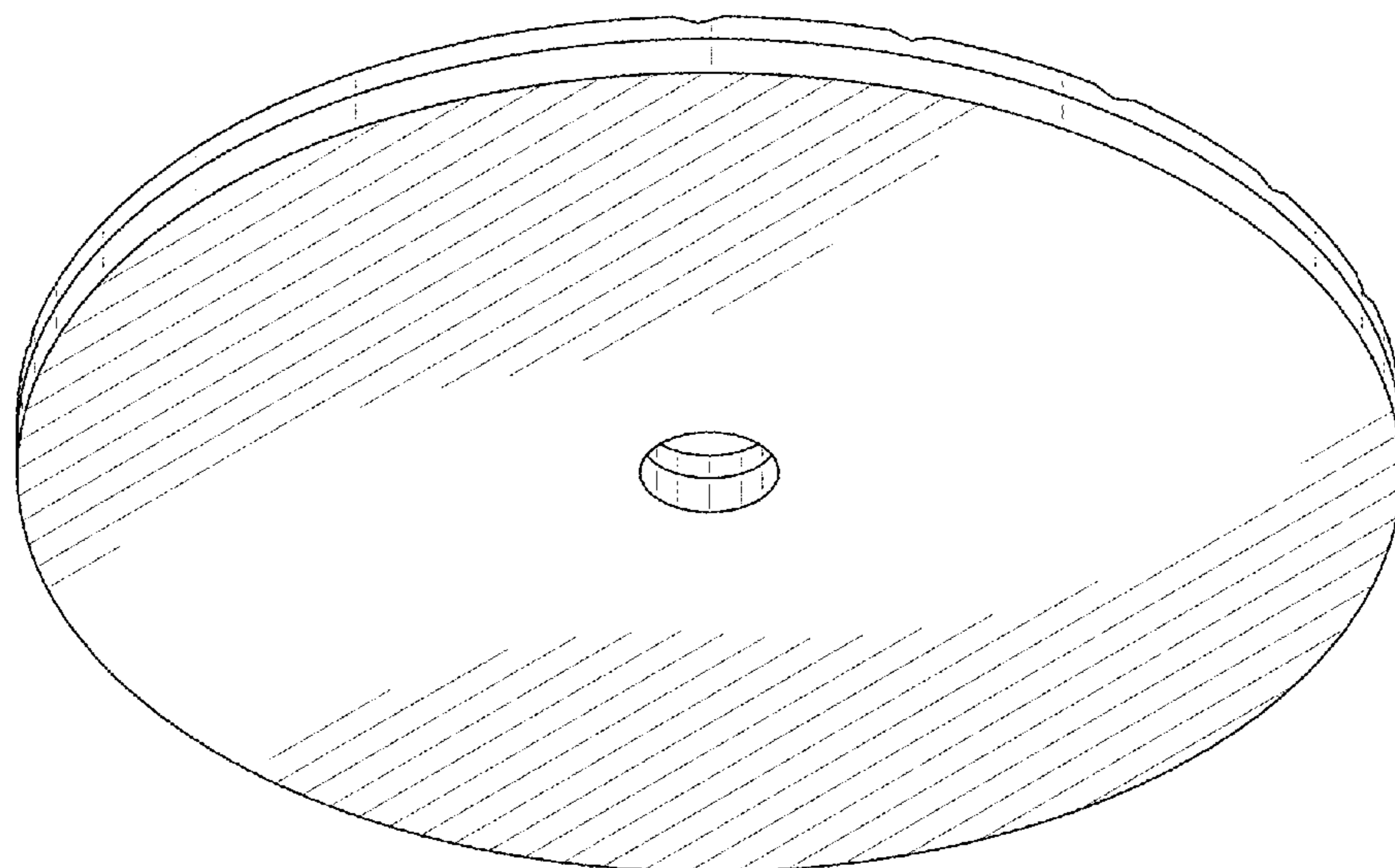

FIG. 2

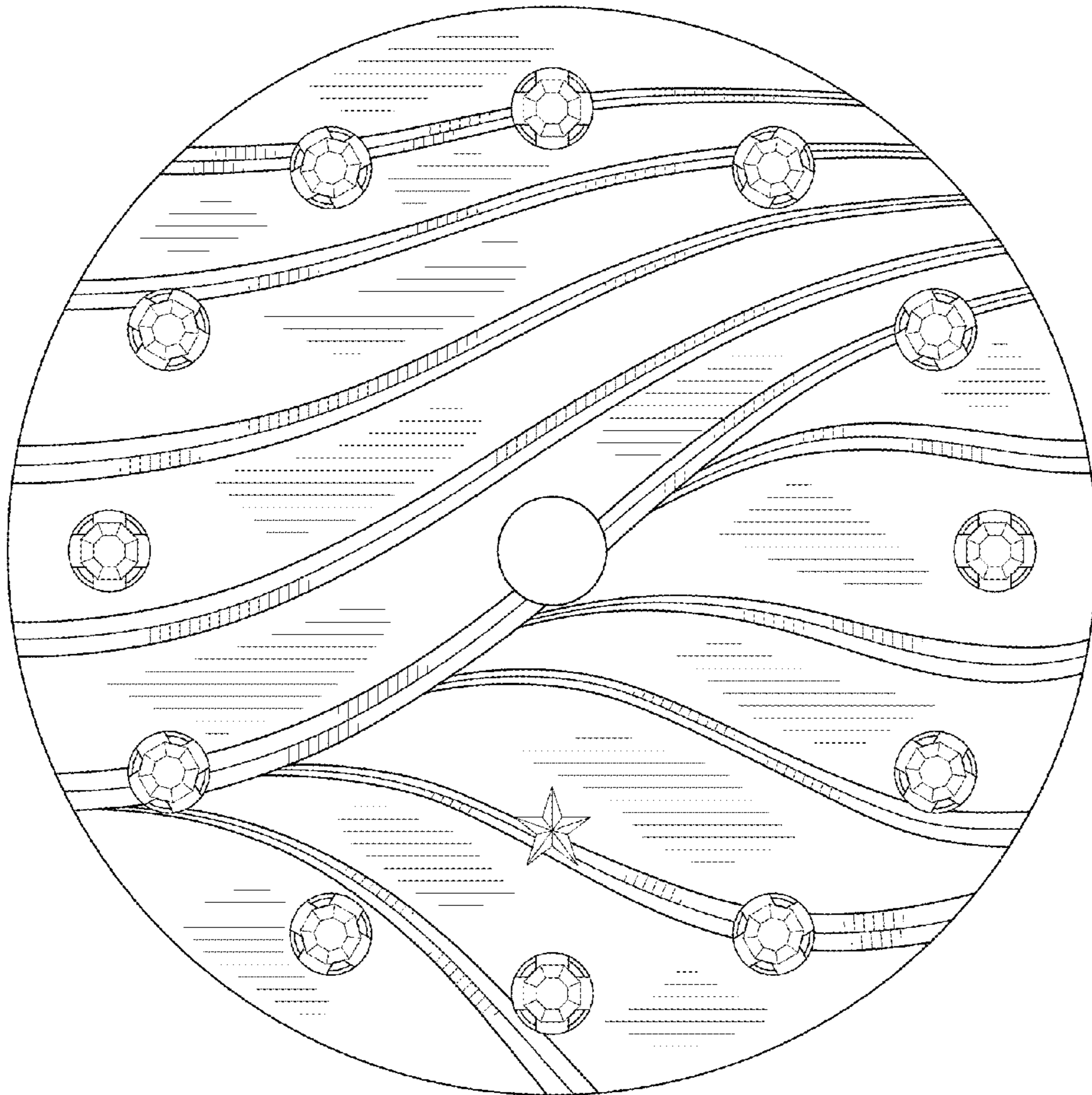

FIG. 3

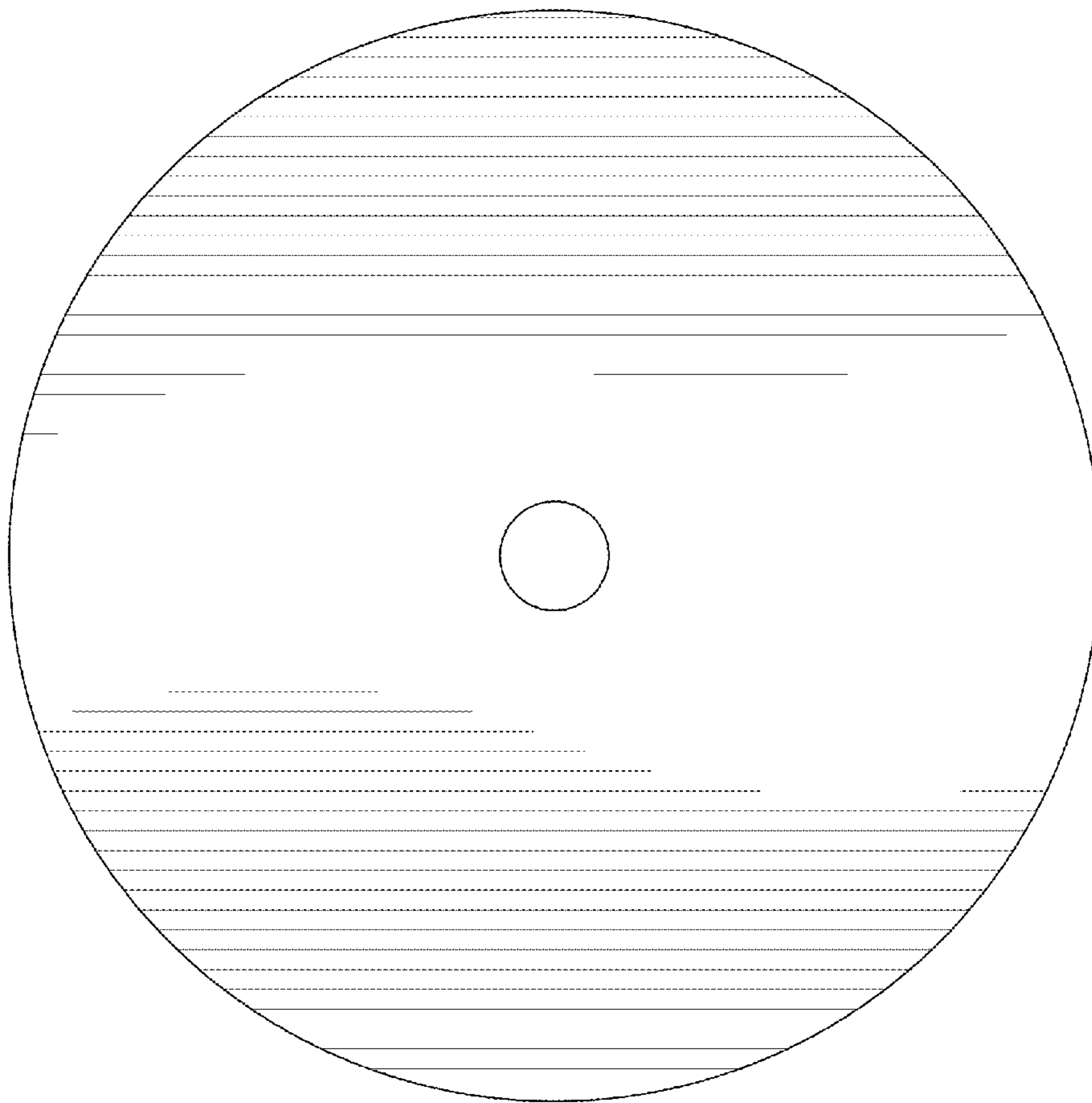

FIG. 4

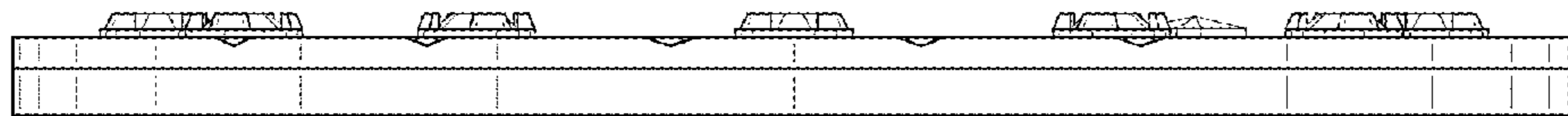

FIG. 5

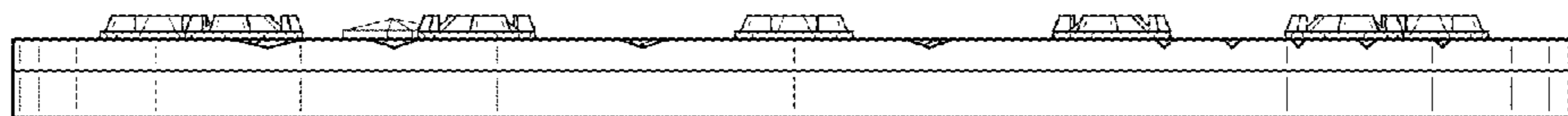

FIG. 6

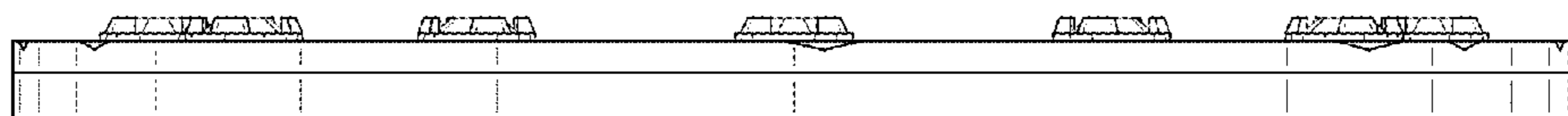

FIG. 7

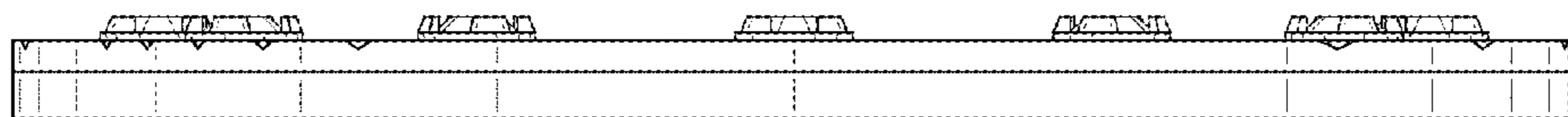

FIG. 8

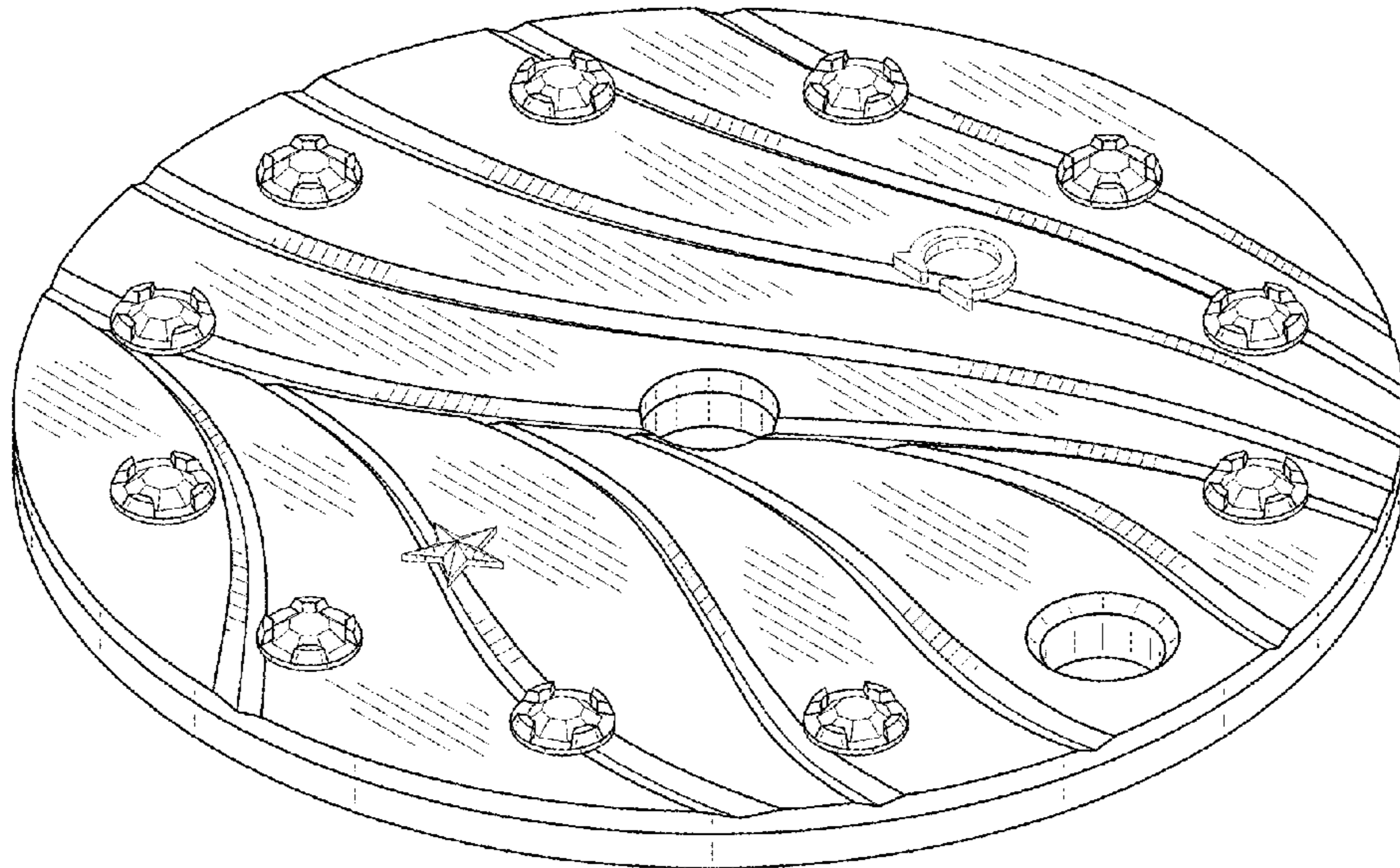

FIG. 9

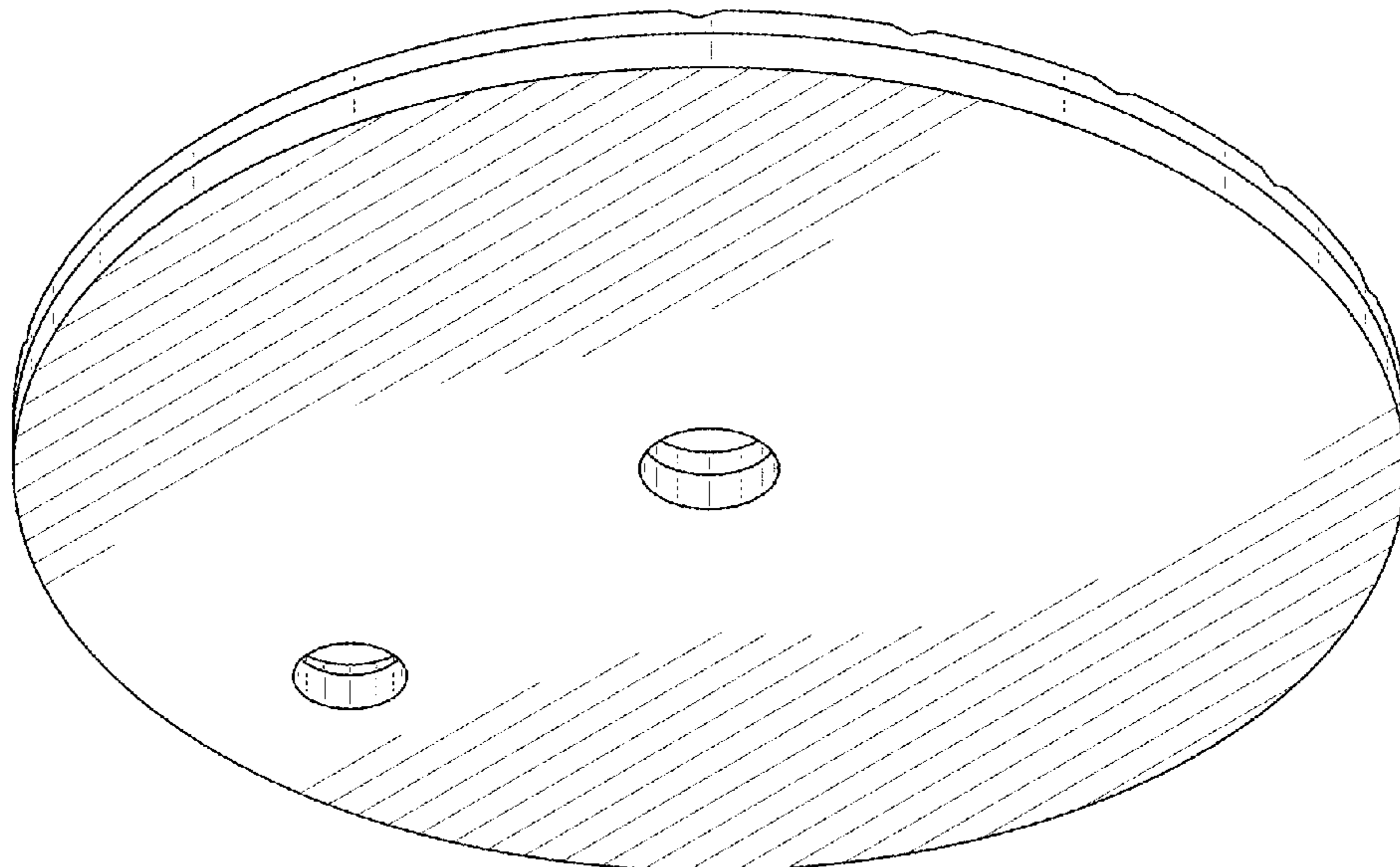

FIG. 10

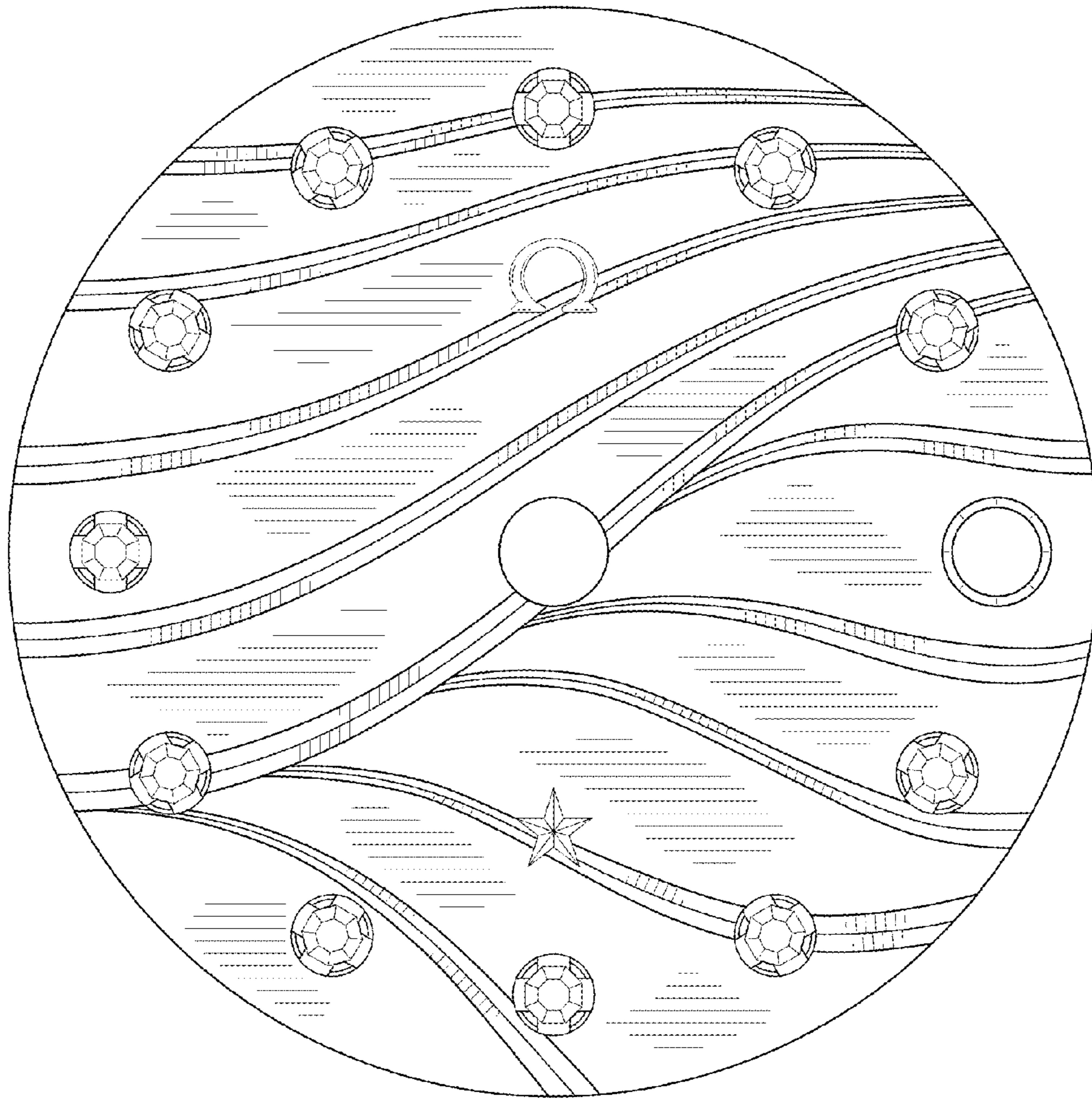

FIG. 11

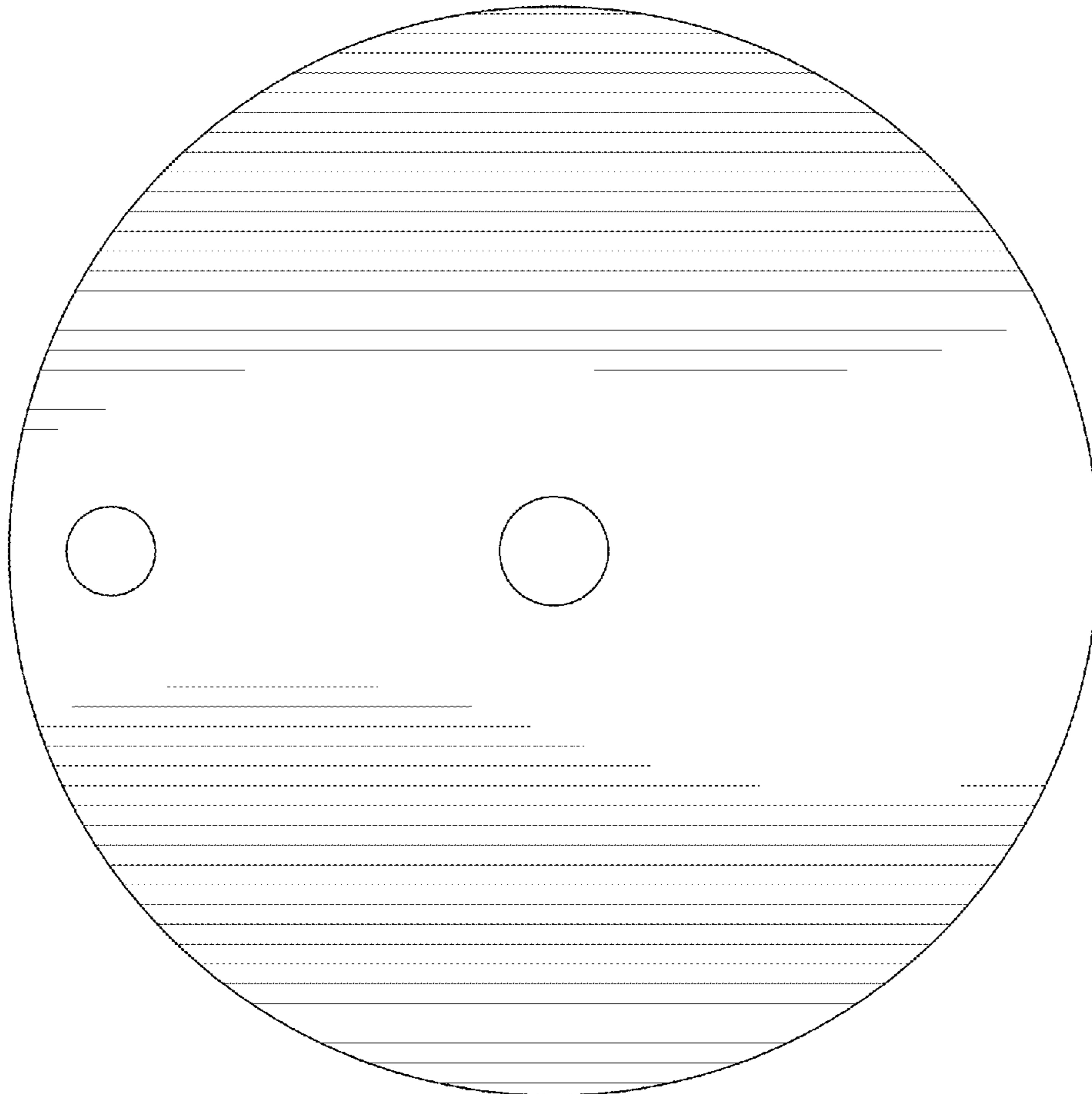

FIG. 12

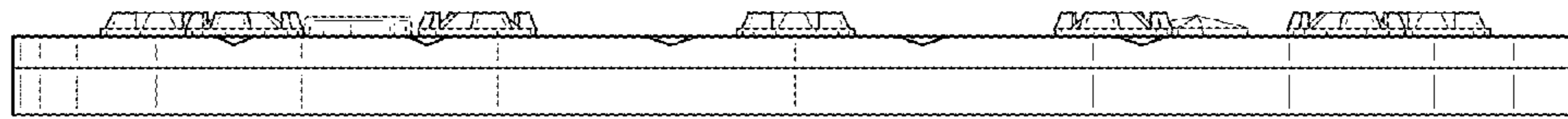

FIG. 13

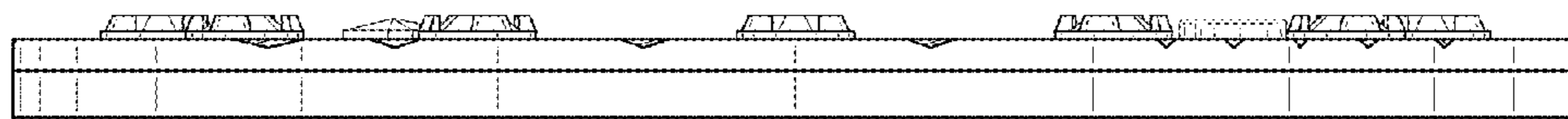

FIG. 14

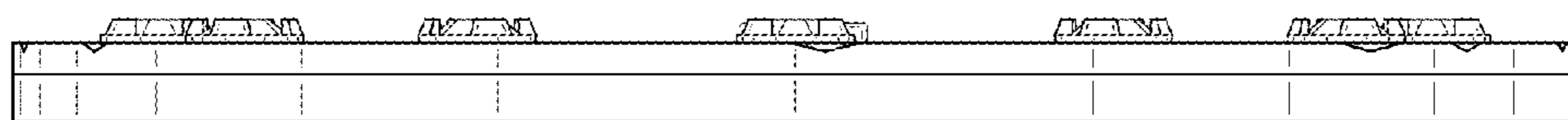

FIG. 15

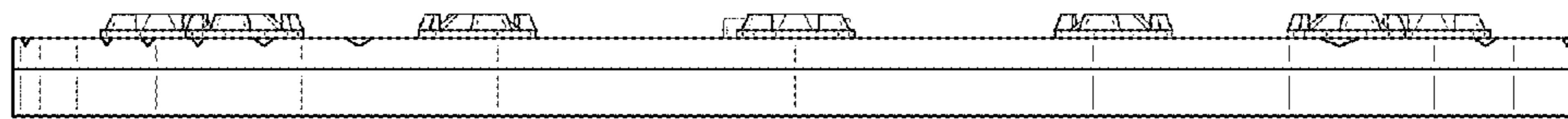

FIG. 16