



US00D723936S

(12) **United States Design Patent**  
**Musaliar**

(10) **Patent No.:** **US D723,936 S**  
(45) **Date of Patent:** **\*\* \*Mar. 10, 2015**

- (54) **STORAGE BAG**
  - (71) Applicant: **S.C. Johnson & Son, Inc.**, Racine, WI (US)
  - (72) Inventor: **Imtiaz A. Musaliar**, Racine, WI (US)
  - (73) Assignee: **S.C. Johnson & Son, Inc.**, Racine, WI (US)
  - (\*) Notice: This patent is subject to a terminal disclaimer.
  - (\*\*) Term: **14 Years**
  - (21) Appl. No.: **29/449,687**
  - (22) Filed: **Mar. 15, 2013**
  - (51) **LOC (10) Cl.** ..... **09-05**
  - (52) **U.S. Cl.**  
USPC ..... **D9/705**
  - (58) **Field of Classification Search**  
USPC ..... D9/702-714, 499, 434-435, 443, 415;  
D24/118, 121; 426/106; 383/61.1, 42,  
383/119, 108, 103, 106, 120, 127; 222/92,  
222/107, 215; 220/666; 211/85.15;  
206/406, 811, 484, 260; 428/35.2;  
D3/203.1, 203.2, 303
- See application file for complete search history.

- 5,070,584 A 12/1991 Dais et al.
- D323,979 S 2/1992 Forman et al.
- 5,140,727 A 8/1992 Dais et al.
- 5,152,613 A 10/1992 Herrington, Jr.
- 5,259,904 A 11/1993 Ausnit
- 5,308,666 A 5/1994 Borchardt
- 5,356,222 A 10/1994 Kettner et al.
- 5,382,094 A 1/1995 Ausnit

(Continued)

**FOREIGN PATENT DOCUMENTS**

- EP 0089680 A2 9/1983
- EP 0997391 A1 5/2000

(Continued)

**OTHER PUBLICATIONS**

Pictures of Ziploc® Brand Bags—Quart Size Storage Bag. (pictures taken Mar. 15, 2013).

(Continued)

*Primary Examiner* — Caron D Veynar  
*Assistant Examiner* — Abraham Bahta

(57) **CLAIM**

The ornamental design for a storage bag, as shown and described.

**DESCRIPTION**

FIG. 1 is a front view of a storage bag showing our new design;  
 FIG. 2 is a rear view thereof;  
 FIG. 3 is a left side view thereof;  
 FIG. 4 is a right side view thereof;  
 FIG. 5 is a top view thereof; and,  
 FIG. 6 is a bottom view thereof.

The broken lines show portions of the storage bag which form no part of the claimed design. The dot-dash lines show unclaimed boundaries and form no part of the claimed design. The shade lines in the Figures show transparency or translucency.

**1 Claim, 4 Drawing Sheets**

- (56) **References Cited**
- U.S. PATENT DOCUMENTS
- 144,238 A 11/1873 Stow
- D254,478 S \* 3/1980 Carroll ..... D9/704
- D261,861 S \* 11/1981 Carter ..... D9/704
- 4,363,345 A 12/1982 Scheibner
- 4,372,014 A 2/1983 Simpson
- 4,479,244 A 10/1984 Ausnit
- 4,654,878 A 3/1987 Lems
- 4,658,433 A 4/1987 Savicki
- D297,306 S 8/1988 King
- 4,925,316 A 5/1990 Van Erden et al.
- 5,009,828 A 4/1991 McCree

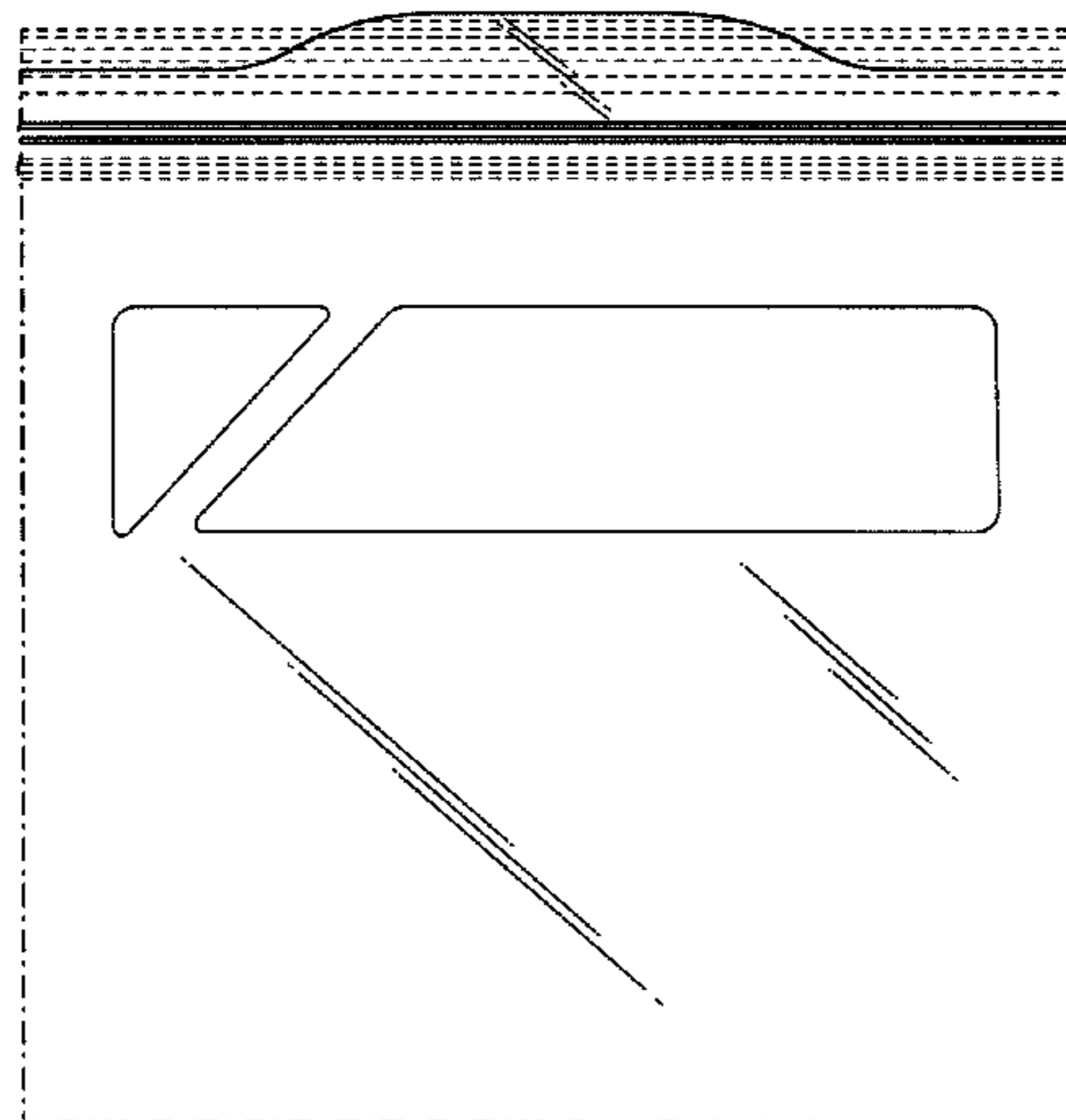

(56)

References Cited

U.S. PATENT DOCUMENTS

5,397,182 A 3/1995 Gaible et al.  
 5,544,752 A 8/1996 Cox  
 5,554,093 A 9/1996 Porchia et al.  
 5,611,627 A 3/1997 Belias et al.  
 5,618,111 A 4/1997 Porchia et al.  
 5,647,100 A 7/1997 Porchia et al.  
 5,783,012 A 7/1998 Porchia et al.  
 5,791,783 A 8/1998 Porchia et al.  
 5,832,145 A 11/1998 Dais et al.  
 5,908,245 A 6/1999 Bost et al.  
 5,967,663 A 10/1999 Vaquero et al.  
 D419,435 S \* 1/2000 Bonfigli ..... D9/707  
 D452,818 S \* 1/2002 Berman ..... D9/707  
 6,386,762 B1 5/2002 Randall et al.  
 6,481,891 B2 11/2002 Yeager  
 6,572,267 B1 6/2003 Forman  
 6,594,872 B2 7/2003 Cisek  
 6,846,107 B2 1/2005 Sweeney et al.  
 D502,392 S \* 3/2005 Maher et al. .... D9/418  
 6,874,938 B2 4/2005 Price et al.  
 6,877,898 B2 4/2005 Berich et al.  
 6,983,845 B2 1/2006 Shah et al.  
 7,033,077 B2 4/2006 Taylor  
 7,077,570 B2 7/2006 Fukumori et al.  
 7,134,788 B2 11/2006 Hsiang  
 7,260,871 B2 8/2007 Borchardt et al.  
 D553,506 S \* 10/2007 Parenteau ..... D9/715  
 D557,148 S 12/2007 Kapinos, Sr.  
 7,316,052 B2 1/2008 Pawloski et al.  
 7,452,131 B2 11/2008 Kettner et al.  
 7,543,361 B2 6/2009 Borchardt et al.  
 7,556,429 B2 7/2009 Taheri  
 D597,857 S 8/2009 Lin  
 7,585,111 B2 9/2009 Turvey et al.  
 D602,377 S 10/2009 Lin  
 7,611,284 B2 11/2009 Borchardt et al.  
 7,651,271 B2 1/2010 Withers  
 7,674,040 B2 3/2010 Dowd et al.  
 7,743,474 B2 6/2010 May  
 7,784,160 B2 8/2010 Dais et al.  
 D623,075 S 9/2010 Blythe  
 D628,882 S \* 12/2010 Work et al. .... D9/418  
 7,886,412 B2 2/2011 Dais et al.  
 D634,645 S 3/2011 LaFauci et al.  
 7,946,766 B2 5/2011 Dais et al.  
 7,967,509 B2 6/2011 Turvey et al.  
 D642,069 S 7/2011 LaFauci et al.  
 D642,070 S 7/2011 LaFauci et al.  
 D644,120 S \* 8/2011 Kight et al. .... D9/702  
 D644,121 S \* 8/2011 Kight et al. .... D9/707  
 D644,122 S \* 8/2011 Kight et al. .... D9/707  
 8,061,898 B2 11/2011 Pawloski et al.  
 8,075,186 B2 12/2011 Borchardt et al.  
 8,157,444 B2 4/2012 Broering et al.  
 8,192,085 B2 6/2012 Pawloski et al.  
 8,197,138 B2 6/2012 Turvey  
 8,197,139 B2 6/2012 Turvey et al.  
 D677,576 S \* 3/2013 Gridley ..... D9/601  
 8,550,715 B2 10/2013 Anzini et al.  
 8,550,716 B2 10/2013 Smith et al.

2003/0138171 A1 7/2003 Kikuchi  
 2003/0177619 A1 9/2003 Cisek  
 2004/0042688 A1 3/2004 Lee  
 2004/0078940 A1 4/2004 Ishizaki  
 2004/0128805 A1 7/2004 Fukumori et al.  
 2004/0179754 A1 9/2004 Taheri  
 2005/0063621 A1 3/2005 Kettner et al.  
 2005/0276524 A1 12/2005 Taheri  
 2005/0281489 A1 12/2005 Yeh et al.  
 2006/0188180 A1 8/2006 Otsubo  
 2007/0098308 A1 5/2007 Taheri  
 2008/0105679 A1 5/2008 Ballard  
 2008/0159662 A1 7/2008 Dowd et al.  
 2009/0154843 A1 6/2009 May  
 2009/0324141 A1 12/2009 Dais et al.  
 2010/0021090 A1 1/2010 Wilske  
 2010/0142859 A1 6/2010 Cushman  
 2010/0303390 A1 12/2010 Ackerman et al.  
 2011/0044565 A1 2/2011 Pawloski et al.  
 2011/0044566 A1 2/2011 Fish et al.  
 2011/0176751 A1 7/2011 Anzini et al.  
 2011/0268373 A1 11/2011 Polland  
 2011/0311169 A1 12/2011 Smith et al.  
 2013/0195384 A1 8/2013 Dais et al.

FOREIGN PATENT DOCUMENTS

EP 1375368 A2 1/2004  
 EP 1204560 B1 3/2004  
 EP 1375368 A3 6/2005  
 JP 2010030627 A 2/2010  
 WO WO 01/14217 A1 3/2001  
 WO WO2006127739 A2 11/2006  
 WO WO2007143648 A2 12/2007  
 WO WO2009106935 A3 12/2009

OTHER PUBLICATIONS

Pictures of Ziploc® Brand Bags—Sandwich Size Storage Bag. (pictures taken Mar. 15, 2013).  
 Co-pending U.S. Appl. No. 13/631,513, filed Sep. 28, 2012.  
 Co-pending U.S. Appl. No. 13/631,549, filed Sep. 28, 2012.  
 Co-pending U.S. Appl. No. 13/631,580, filed Sep. 28, 2012.  
 Co-pending U.S. Appl. No. 13/631,617, filed Sep. 28, 2012.  
 Co-pending U.S. Appl. No. 13/631,636, filed Sep. 28, 2012.  
 Co-pending U.S. Appl. No. 13/804,234, filed Mar. 14, 2013.  
 Co-pending U.S. Appl. No. 29/449,559, filed Mar. 15, 2013.  
 Co-pending U.S. Appl. No. 29/449,579, filed Mar. 15, 2013.  
 Co-pending U.S. Appl. No. 29/449,596, filed Mar. 15, 2013.  
 Co-pending U.S. Appl. No. 29/449,633, filed Mar. 15, 2013.  
 Co-pending U.S. Appl. No. 29/449,652, filed Mar. 15, 2013.  
 Co-pending U.S. Appl. No. 29/449,674, filed Mar. 15, 2013.  
 Co-pending U.S. Appl. No. 29/449,706, filed Mar. 15, 2013.  
 Co-pending U.S. Appl. No. 29/449,727, filed Mar. 15, 2013.  
 Co-pending U.S. Appl. No. 14/176,244, filed Feb. 10, 2014.  
 Co-pending U.S. Appl. No. 14/204,075, filed Mar. 11, 2014.  
 Co-pending U.S. Appl. No. 14/222,702, filed Mar. 24, 2014.  
 Co-pending U.S. Appl. No. 14/222,711, filed Mar. 24, 2014.  
 U.S. Appl. No. 61/830,477, filed Jun. 3, 2013.

\* cited by examiner

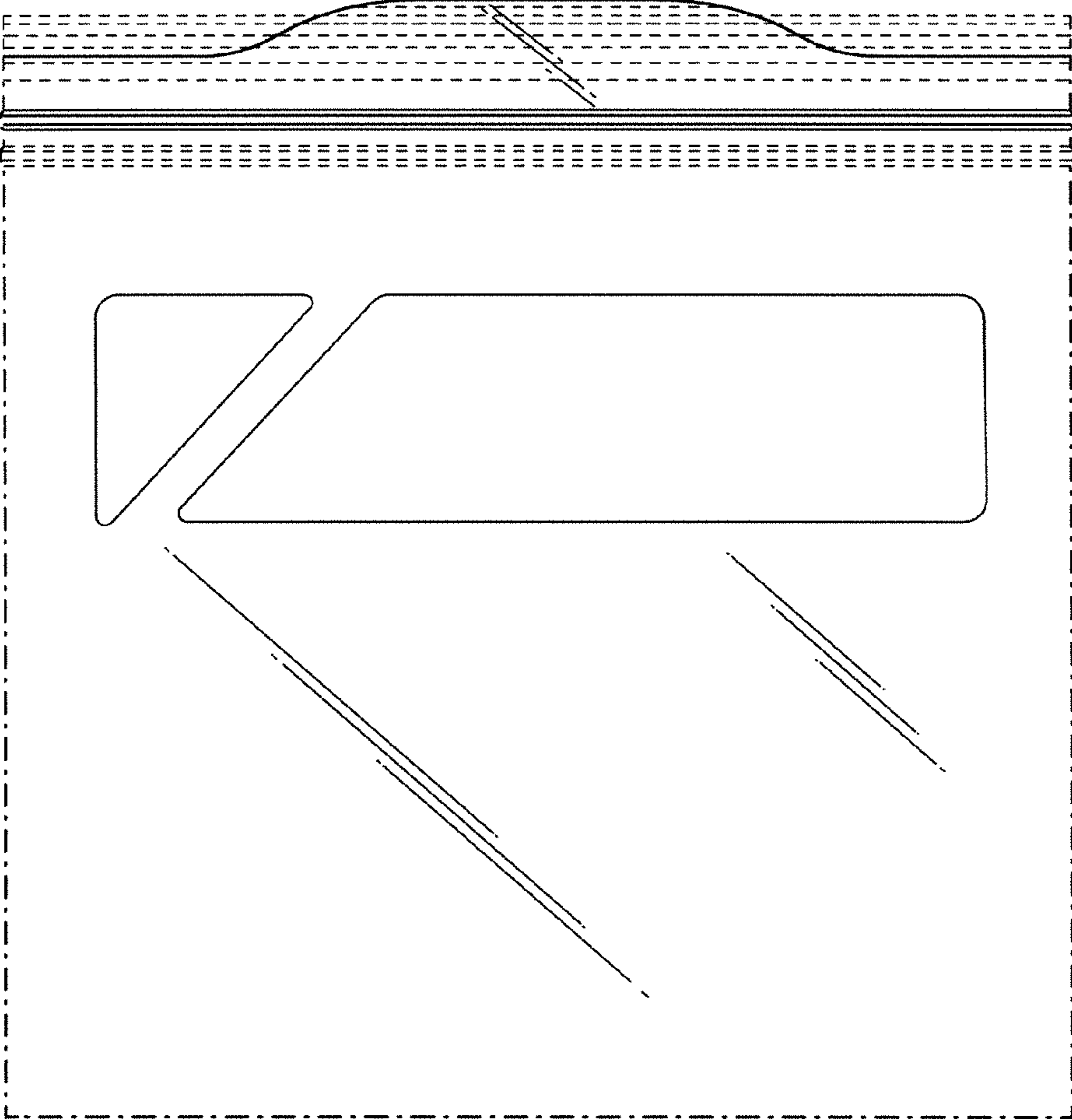

FIG. 1

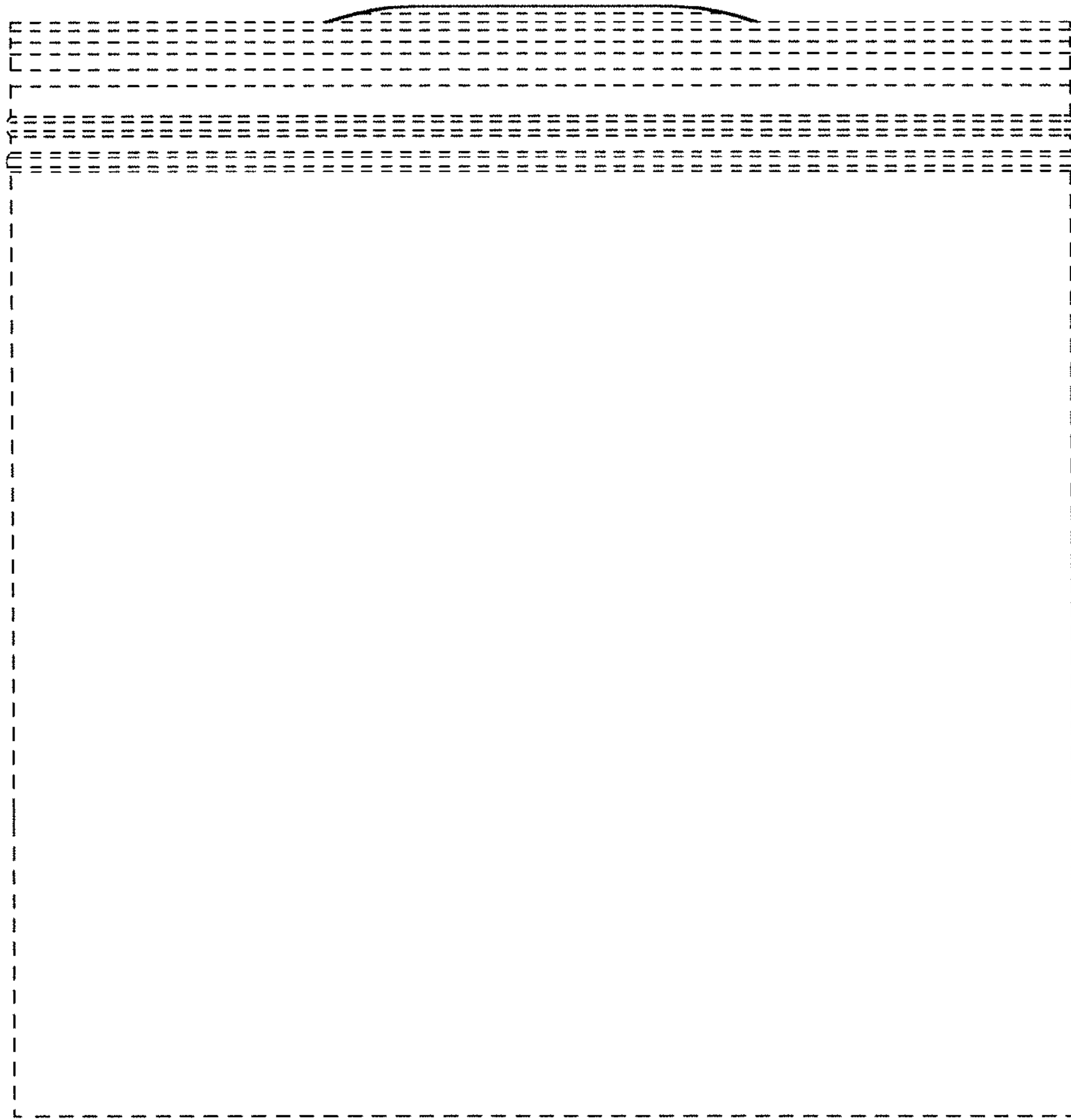

FIG. 2

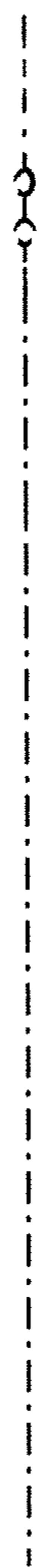

FIG. 3

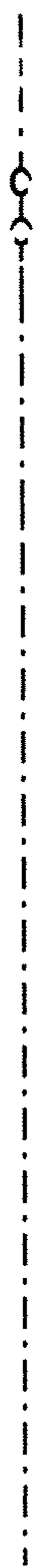

FIG. 4

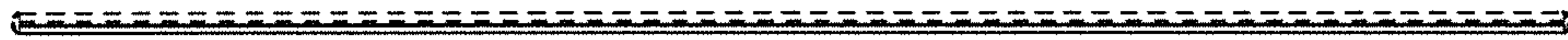

FIG. 5

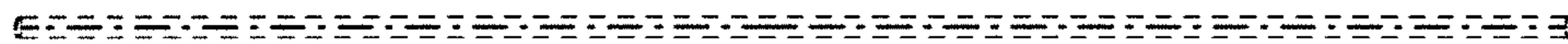

FIG. 6