



US00D723871S

(12) **United States Design Patent**
Khubani et al.

(10) **Patent No.:** **US D723,871 S**
(45) **Date of Patent:** **** Mar. 10, 2015**

(54) **COMBINATION SNACK AND BEVERAGE CONTAINER**

(71) Applicant: **IdeaVillage Products Corp.**, Wayne, NJ (US)

(72) Inventors: **Anand Khubani**, Towaco, NJ (US);
Jane Gilmartin, Wayne, NJ (US);
LoriAnn Lombardo, Wayne, NJ (US);
Aaron Szymanski, Watertown, CT (US)

(73) Assignee: **IdeaVillage Products, Corp.**, Wayne, NJ (US)

(**) Term: **14 Years**

(21) Appl. No.: **29/481,861**

(22) Filed: **Feb. 11, 2014**

(51) **LOC (10) Cl.** **07-01**

(52) **U.S. Cl.**
USPC **D7/505**

(58) **Field of Classification Search**

USPC D7/300, 302, 303, 305, 317, 321, 387,
D7/396.1, 396.2, 500, 505, 507, 509, 510,
D7/511, 513, 523, 528, 531, 532, 538, 540,
D7/541, 543, 546, 549, 555, 560, 584, 585,
D7/598, 601, 602, 605, 608, 619.1, 622,
D7/624.1, 624.2, 624.3, 629, 637, 638,
D7/645, 701, 703, 705, 706, 707; D9/434,
D9/435, 436, 440, 444, 447, 500, 501, 502,
D9/503, 504, 519, 530, 535, 537, 549, 715,
D9/716, 719, 737, 738, 740, 741, 745,
D9/761; 215/12.1; 220/288, 592.16,
220/592.17, 592.2, 592.24, 592.27, 694,
220/703, 711, 737, 739

See application file for complete search history.

(56) **References Cited**

U.S. PATENT DOCUMENTS

1,665,289 A	4/1928	Weaver
D110,286 S	6/1938	Krehbiel
2,899,098 A	8/1959	Gits
3,128,029 A	4/1964	Price et al.
3,375,954 A	10/1965	Honkanen
3,288,344 A	11/1966	Woolen et al.
3,323,706 A	6/1967	Gereke
4,054,205 A	10/1977	Blow, Jr. et al.
4,136,799 A	1/1979	Albert
D285,999 S	10/1986	Ludwick
4,823,958 A	4/1989	Mahmud
4,883,935 A	11/1989	Fairchild et al.

(Continued)

Primary Examiner — Susan Bennett Hattan

Assistant Examiner — Leanne Was

(74) *Attorney, Agent, or Firm* — Dan DeLaRose

(57) **CLAIM**

The ornamental design for a combination snack and beverage container, as shown and described.

DESCRIPTION

FIG. 1 is an isometric view showing the back and top sides of the design;

FIG. 2 is a plan view showing the front of the design;

FIG. 3 is a plan view showing the back of the design;

FIG. 4 is a plan view showing the right side of the design;

FIG. 5 is a plan view showing the left side of the design;

FIG. 6 is a plan view showing the top of the design;

FIG. 7 is a plan view showing the bottom of the design; and,

FIG. 8 is a perspective view of the back of the design showing the snack portion in a removed position from the container portion.

The broken lines in the drawing depict unclaimed portions of the combination snack and beverage container only and form no part of the claimed design.

1 Claim, 4 Drawing Sheets

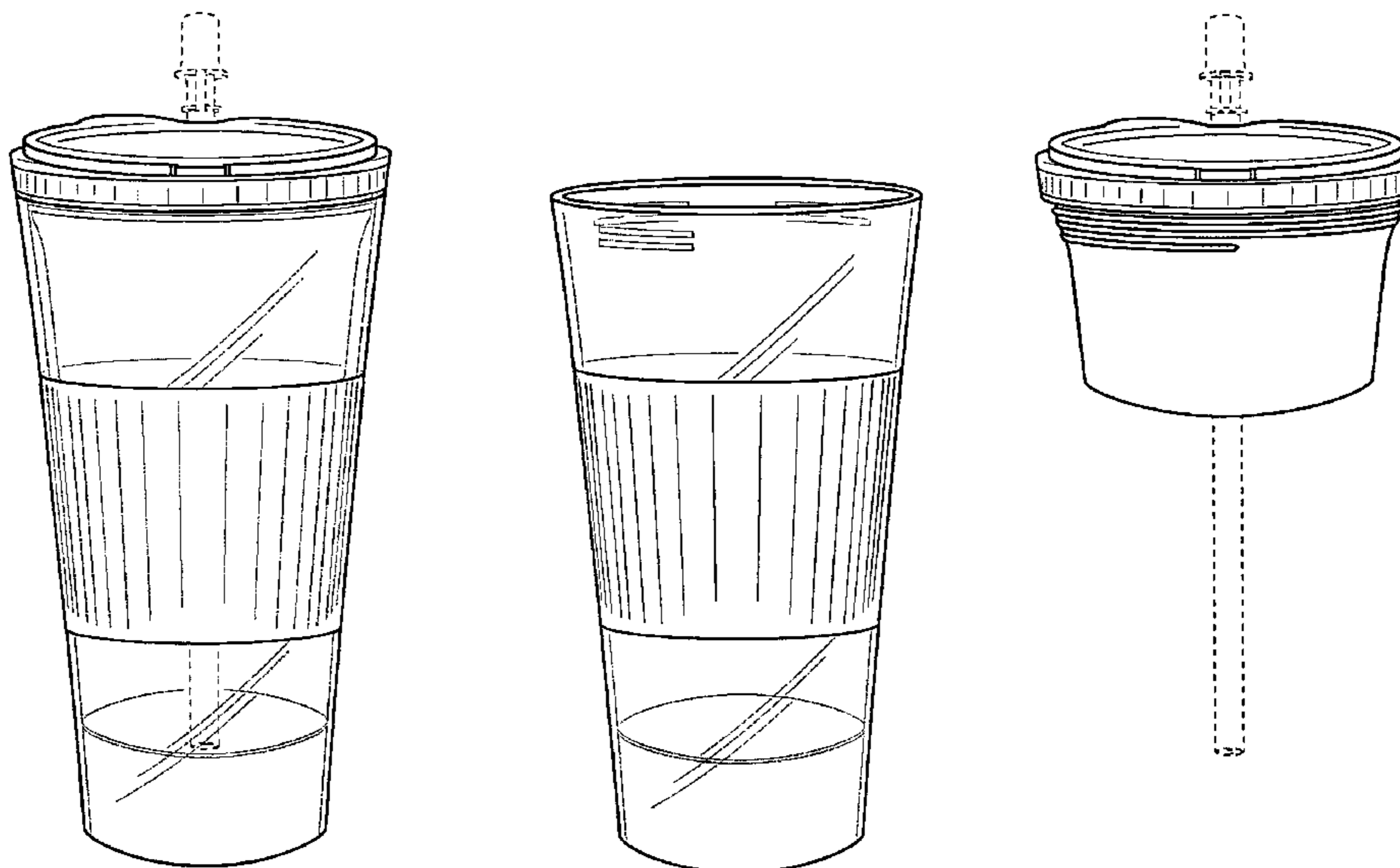

(56)

References Cited

U.S. PATENT DOCUMENTS

5,085,330	A	2/1992	Paulin	D502,396	S	3/2005	Frisch	
5,180,079	A	1/1993	Jeng	6,955,028	B1	10/2005	Dunaway	
5,310,072	A	5/1994	Matusovsky et al.	6,989,168	B2	1/2006	Fahey	
D355,735	S	2/1995	Shaffer et al.	7,182,242	B2	2/2007	Cai	
5,573,131	A	11/1996	Berjis	7,217,434	B1	5/2007	Loh et al.	
D377,293	S	1/1997	Husted	7,341,754	B1	3/2008	Loh et al.	
5,706,980	A	1/1998	Dickerson	D572,531	S	7/2008	Romandy et al.	
D390,002	S	2/1998	Brizard	D572,975	S	* 7/2008	Germany	D7/510
D397,911	S	9/1998	Waldmann	D608,147	S	1/2010	Sykes	
D399,392	S	10/1998	Husted	7,748,536	B2	7/2010	Cassese et al.	
6,079,586	A	6/2000	Hanneman	D640,094	S	6/2011	Carlson et al.	
6,338,417	B1	1/2002	Ferraro	D648,985	S	11/2011	Chiu et al.	
6,427,864	B1	8/2002	Asselin	8,172,103	B2	5/2012	Spyros et al.	
6,472,007	B2	10/2002	Bezek et al.	D662,362	S	* 6/2012	Bickert et al.	D7/510
6,474,494	B1	11/2002	Miller	D669,736	S	* 10/2012	Bodum	D7/510
D466,371	S	12/2002	Parker	8,276,783	B2	10/2012	Lee	
D476,193	S	6/2003	Janky	D674,241	S	* 1/2013	Bickert et al.	D7/510
6,622,615	B2	9/2003	Heczko	8,381,935	B1	2/2013	Buck	
6,706,297	B1	3/2004	Toth et al.	8,596,491	B2	12/2013	Buck	
6,814,250	B1	11/2004	Madsen	D696,906	S	* 1/2014	Roth	D7/510
6,820,767	B2	11/2004	Nicholas	8,708,181	B2	4/2014	Buck	
				D713,202	S	* 9/2014	Lin	D7/511
				2004/0007573	A1	* 1/2004	Kang	220/4.27

* cited by examiner

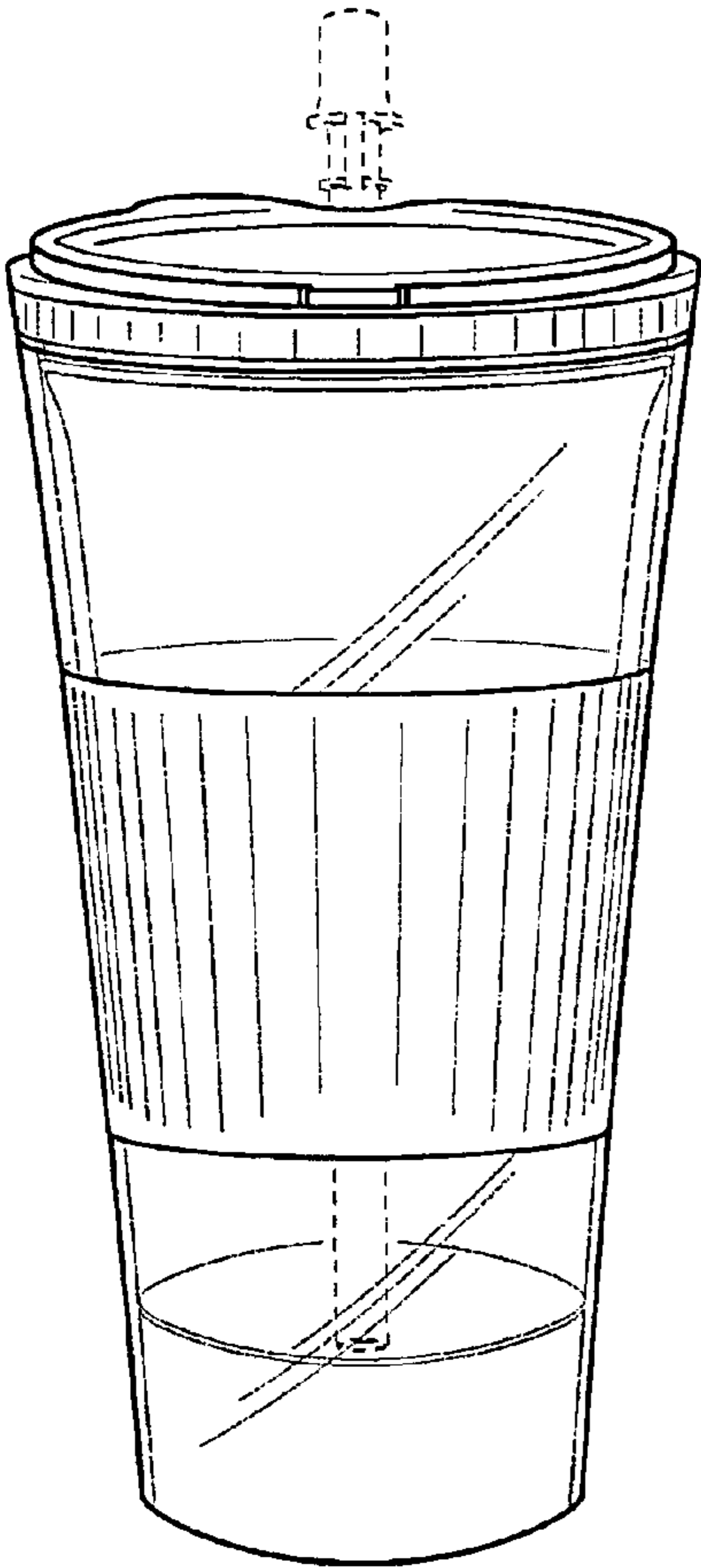

FIG. 1

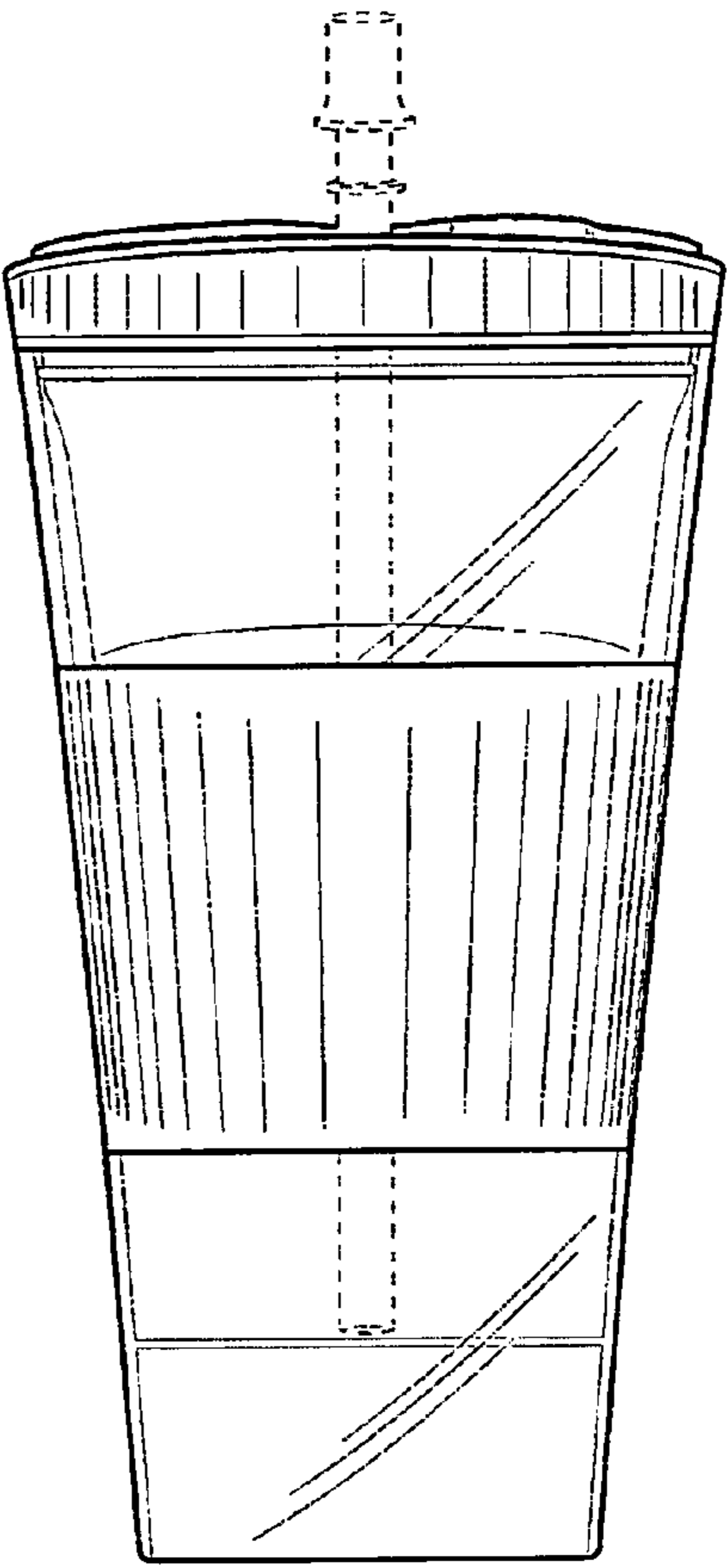

FIG. 2

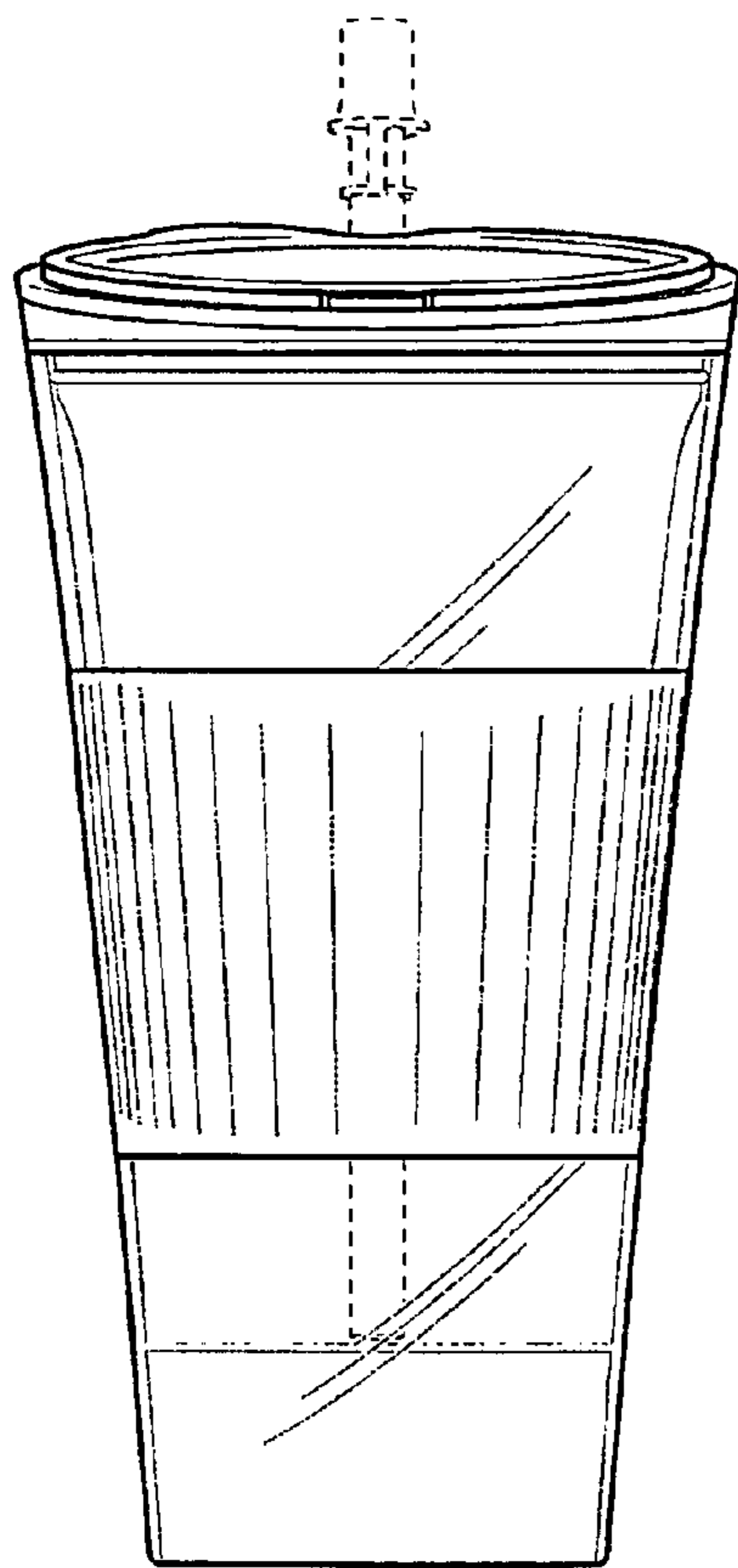

FIG. 3

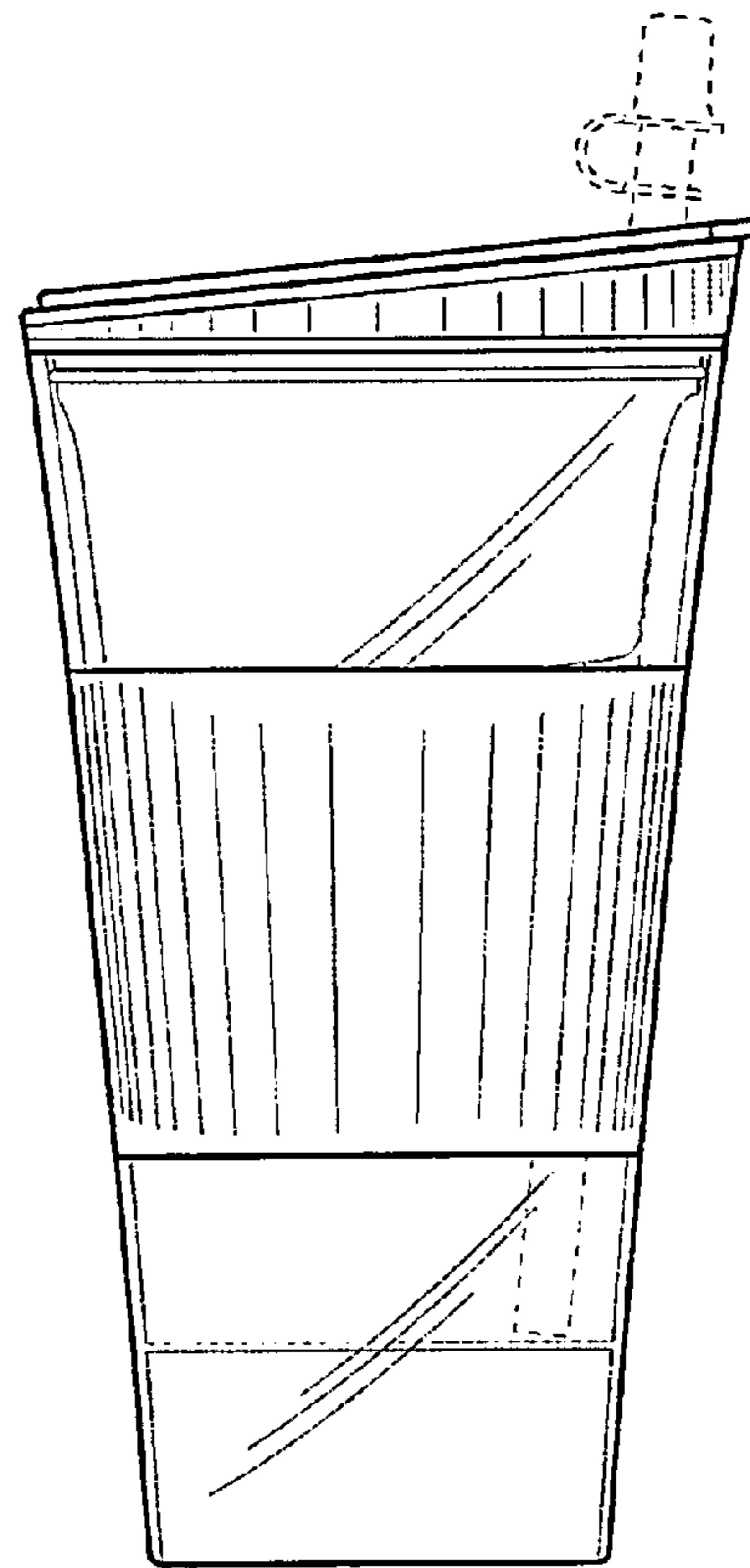

FIG. 4

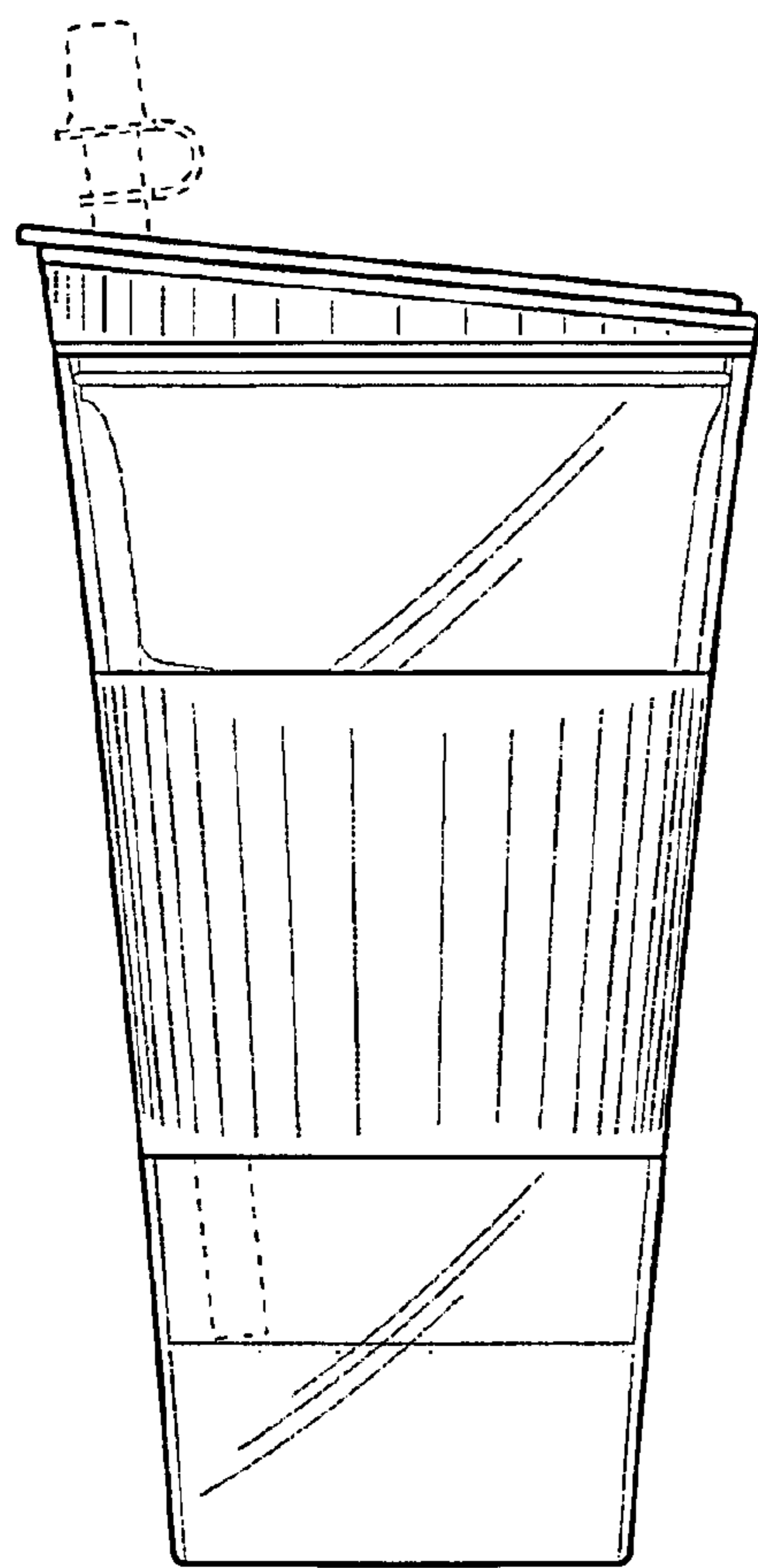

FIG. 5

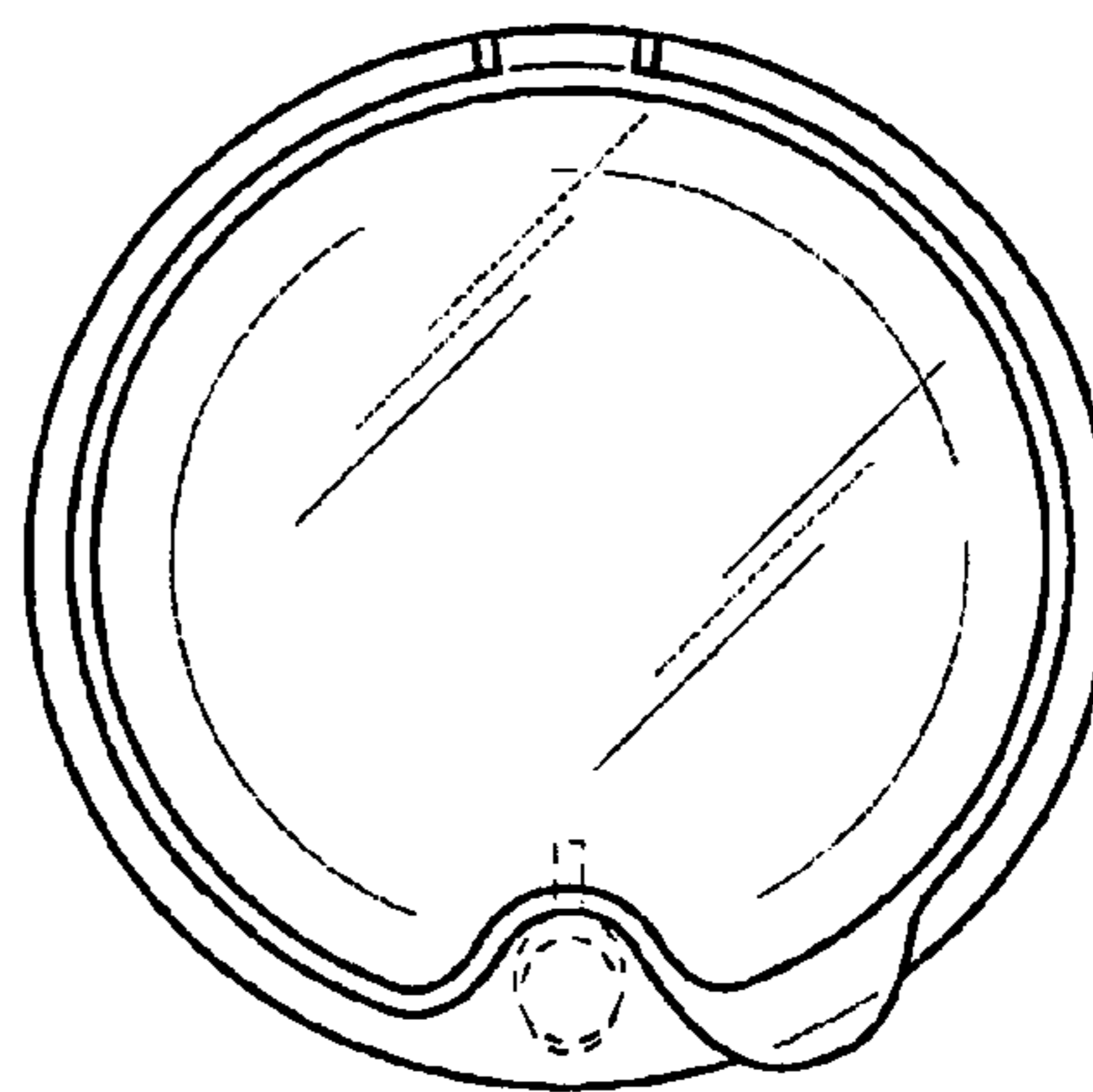

FIG. 6

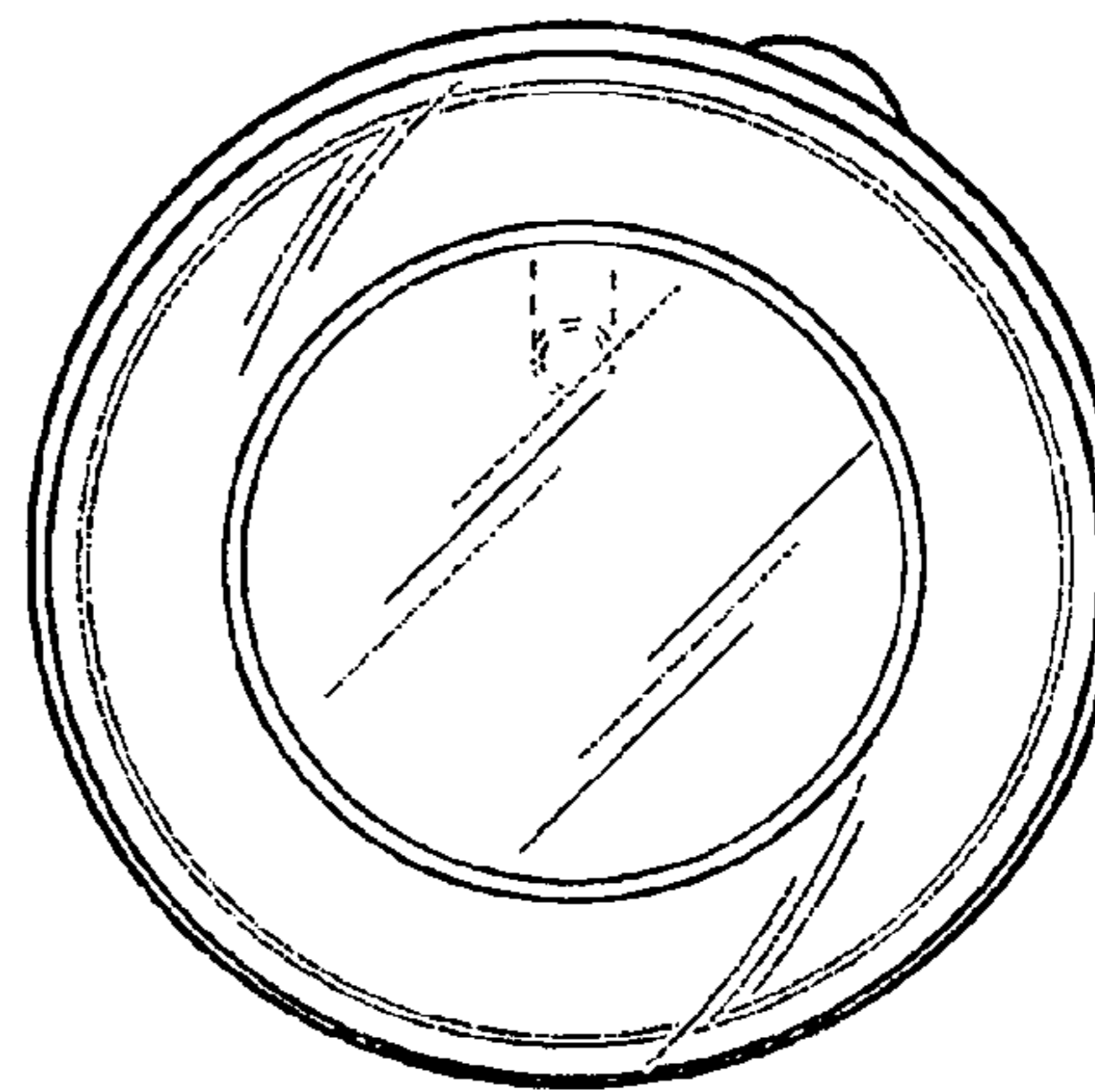

FIG. 7

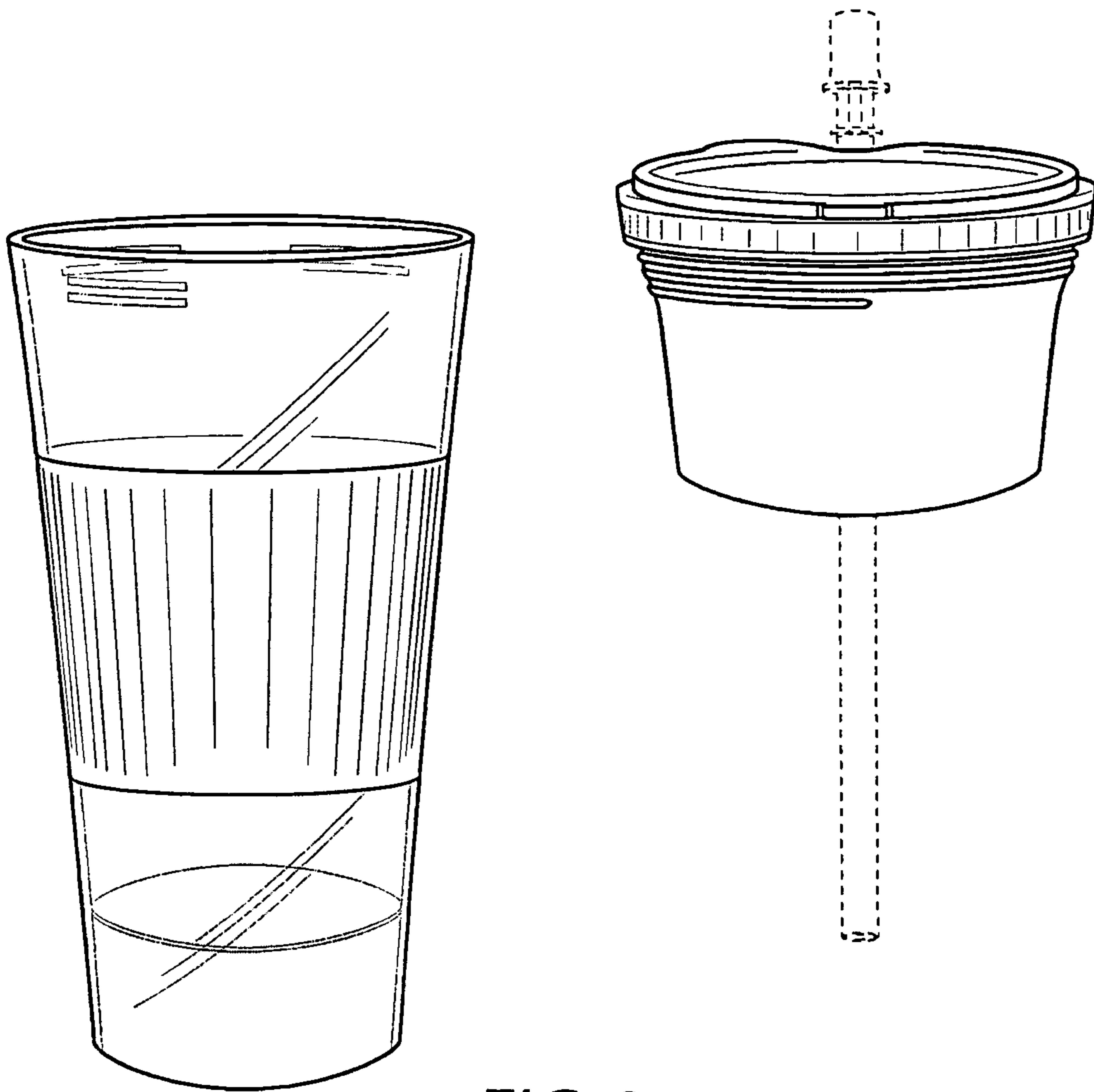

FIG. 8