



US00D723850S

(12) **United States Design Patent**
Mueller et al.

(10) **Patent No.:** **US D723,850 S**
(45) **Date of Patent:** **** Mar. 10, 2015**

(54) **TABLE LEG**

- (71) Applicant: **Steelcase Werndl AG**, Rosenheim (DE)
- (72) Inventors: **Karl-Heinz Mueller**, Prutting (DE);
John Small, London (GB)
- (73) Assignee: **Steelcase Werndl AG**, Rosenheim (DE)
- (**) Term: **14 Years**
- (21) Appl. No.: **29/501,336**
- (22) Filed: **Sep. 3, 2014**

Related U.S. Application Data

- (62) Division of application No. 29/450,662, filed on Mar. 20, 2013.

(30) **Foreign Application Priority Data**

Sep. 20, 2012 (EM) 001345458-0008

(51) **LOC (10) Cl.** **06-06**

(52) **U.S. Cl.**
USPC **D6/709**

(58) **Field of Classification Search**
USPC D6/702, 709, 656.16, 656.17, 685, 691,
D6/691.8; 108/50.01, 50.02, 153.1, 156,
108/157.1, 161, 144.11, 146, 147.19;
248/188, 188.1, 188.7, 188.8

See application file for complete search history.

(56) **References Cited**

U.S. PATENT DOCUMENTS

D144,565 S	4/1946	Hollis	
D216,715 S *	3/1970	Dottinger	D6/495
4,381,861 A	5/1983	Howell, Jr. et al.	
D367,193 S	2/1996	Dame et al.	
D407,245 S	3/1999	Lewis	
D476,178 S	6/2003	Schacht et al.	
7,111,564 B2	9/2006	Chang	
D581,190 S	11/2008	Stoller	
D585,218 S	1/2009	Hamilton et al.	
D591,539 S	5/2009	Bracher	
D593,342 S *	6/2009	Pesso	D6/495
D641,186 S *	7/2011	Martin et al.	D6/495
D651,431 S *	1/2012	Udagawa et al.	D6/495
D655,537 S *	3/2012	Ruiter et al.	D6/495
D659,442 S	5/2012	Henriott et al.	

* cited by examiner

Primary Examiner — Janice Seeger

(74) *Attorney, Agent, or Firm* — Price Heneveld LLP

(57) **CLAIM**

I claim the ornamental design for a table leg, as shown and described.

DESCRIPTION

FIG. 1 is a perspective view of a table leg, showing our new design;
FIG. 2 is right side elevational view;
FIG. 3 is a left side elevational view;
FIG. 4 is a front elevational view;
FIG. 5 is a rear elevational view;
FIG. 6 is a top plan view; and,
FIG. 7 is a bottom plan view thereof.

1 Claim, 5 Drawing Sheets

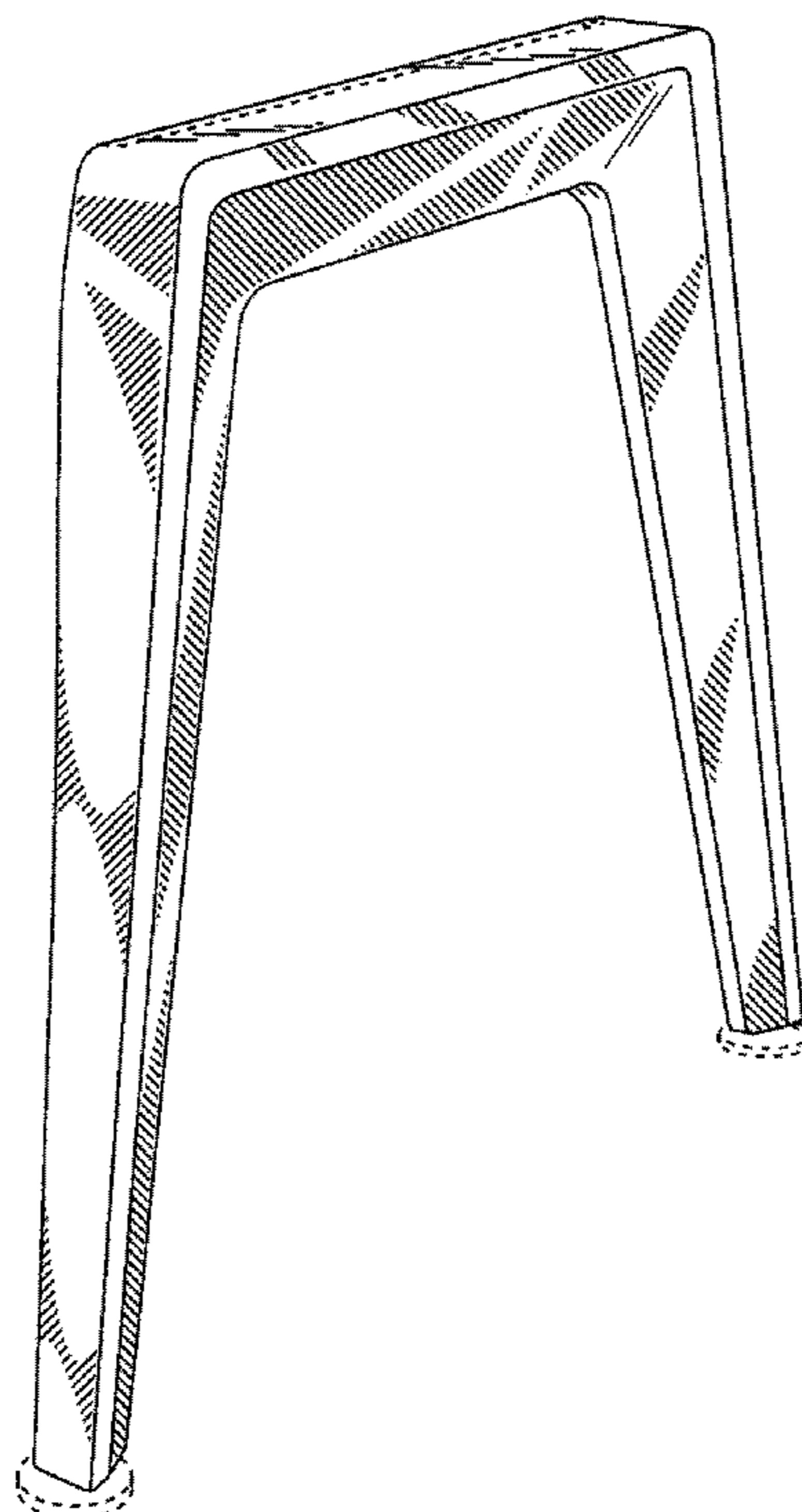

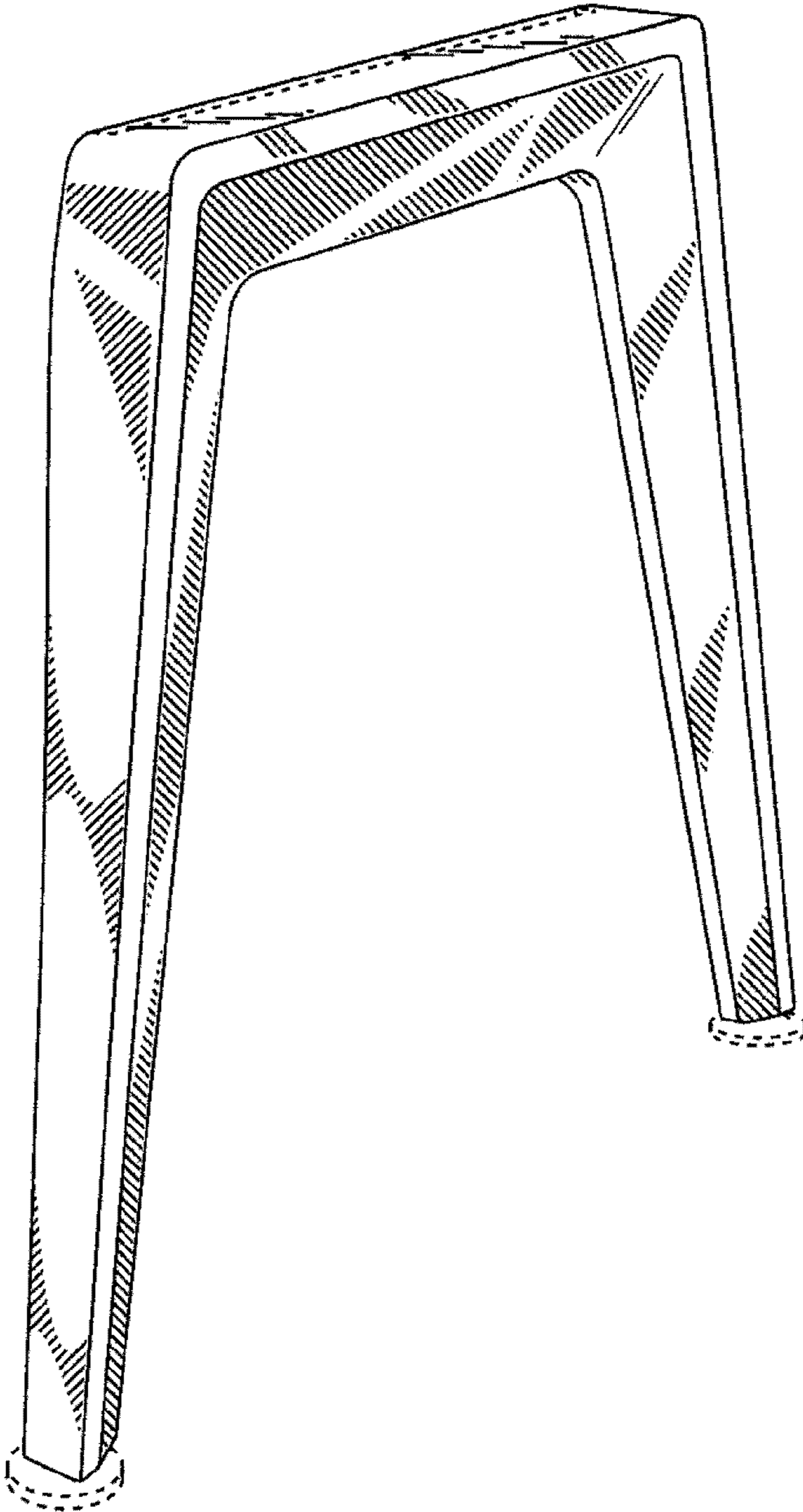

Fig. 1

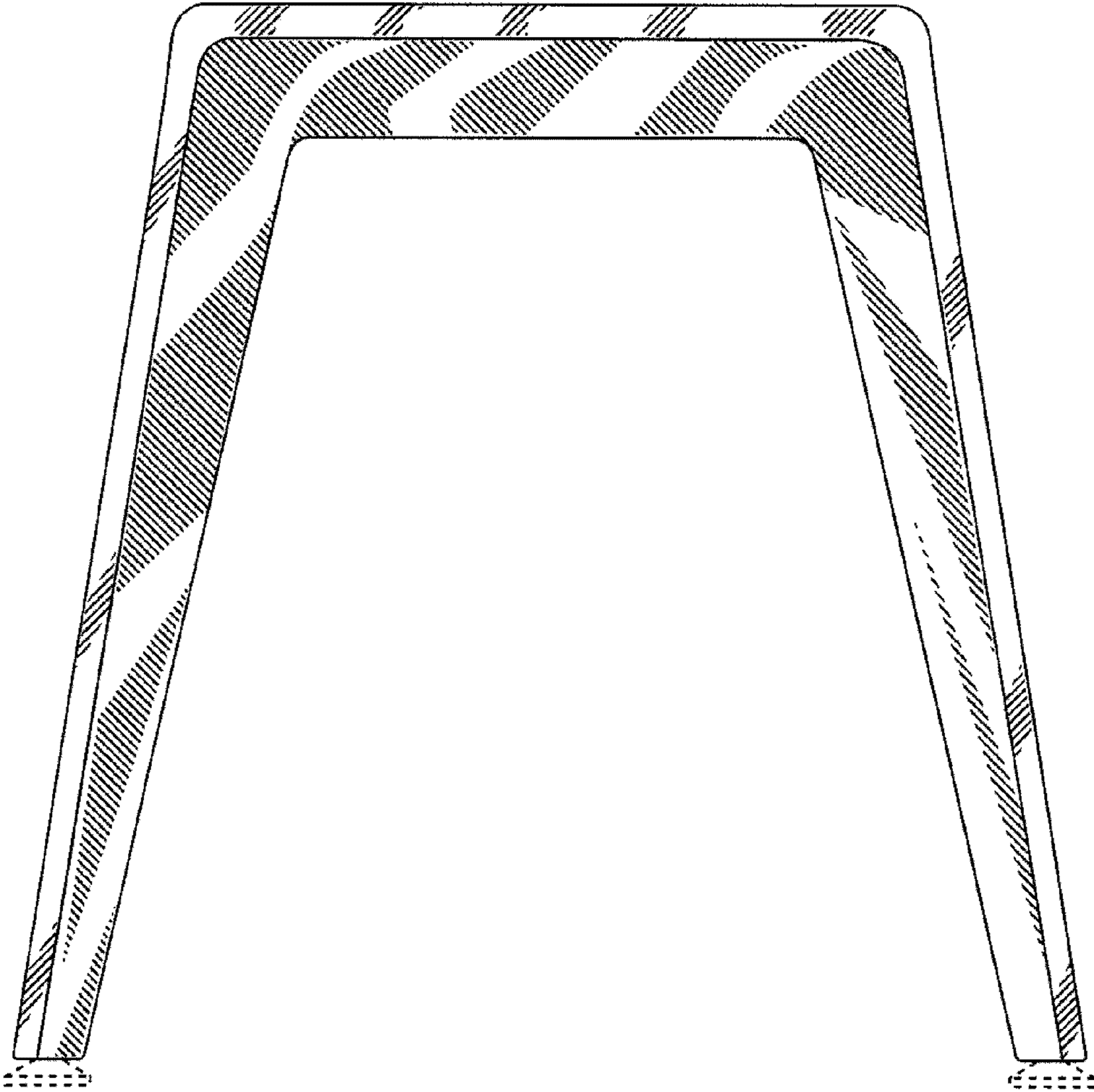

Fig. 2

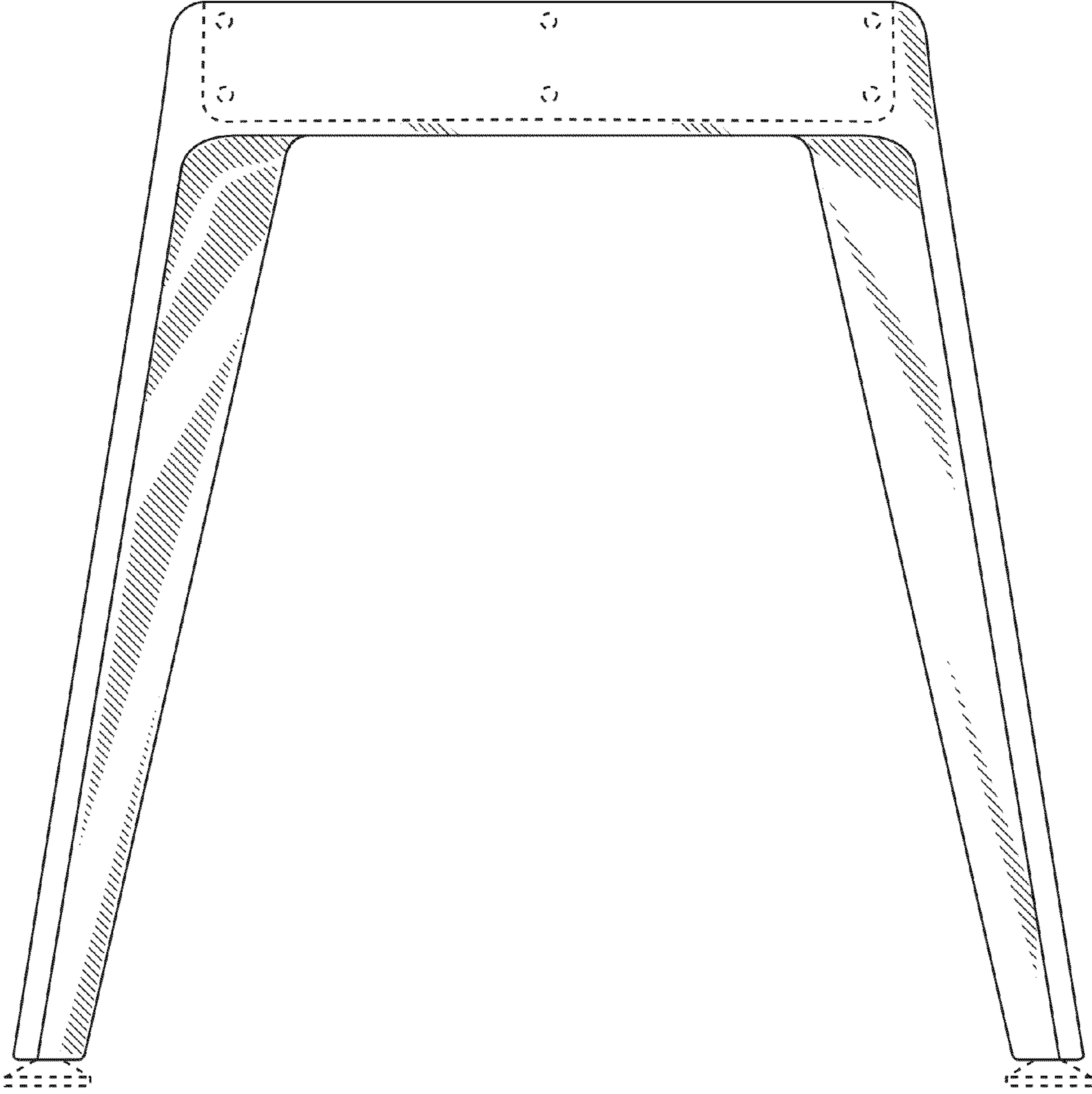

Fig. 3

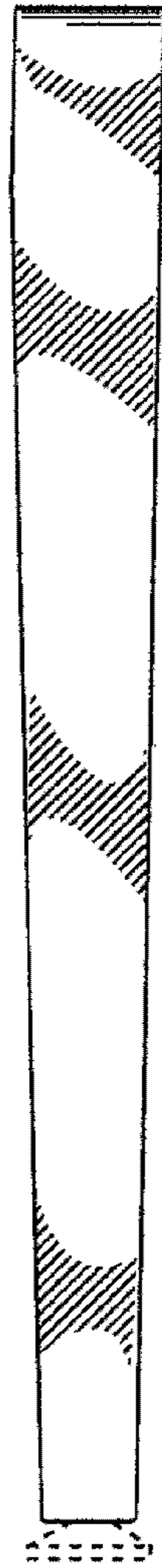

Fig. 4



Fig. 5

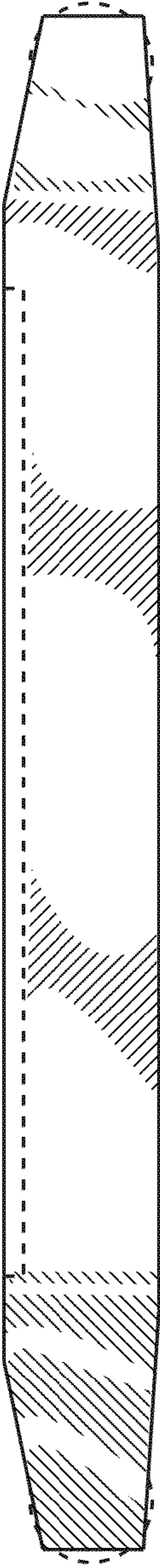

Fig. 6

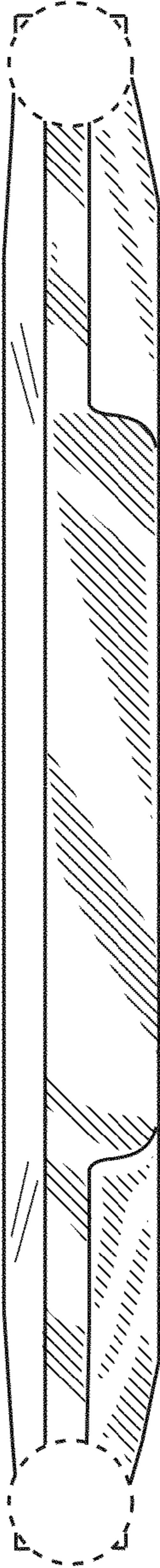

Fig. 7