



US00D723788S

(12) **United States Design Patent**
Raysse

(10) **Patent No.:** **US D723,788 S**
(45) **Date of Patent:** **** Mar. 10, 2015**

- (54) **SHOE UPPER**
- (71) Applicant: **Skechers U.S.A., Inc. II**, Manhattan Beach, CA (US)
- (72) Inventor: **David Raysse**, Los Angeles, CA (US)
- (73) Assignee: **Skechers U.S.A., Inc. II**, Manhattan Beach, CA (US)
- (**) Term: **14 Years**
- (21) Appl. No.: **29/498,474**
- (22) Filed: **Aug. 4, 2014**
- (51) **LOC (10) Cl.** **02-99**
- (52) **U.S. Cl.**
USPC **D2/969**; D2/971
- (58) **Field of Classification Search**
USPC D2/902, 906-908, 923, 939, 969,
D2/971-974; 36/45, 50.1, 77 M, 77 R, 83,
36/13, 114, 126-131
See application file for complete search history.

D490,231 S	5/2004	Estey	
D490,233 S *	5/2004	Cooper	D2/972
D491,718 S *	6/2004	Link	D2/972
D498,356 S	11/2004	Lotti	
D499,863 S	12/2004	Sakai et al.	
D504,012 S	4/2005	Fullum	
6,895,693 B2 *	5/2005	Baruck	36/8.3
D508,767 S *	8/2005	Hatfield	D2/972
D521,218 S *	5/2006	Burg	D2/969
D522,227 S *	6/2006	Young	D2/972
D523,221 S *	6/2006	Portzline	D2/972

(Continued)

Primary Examiner — Dominic Simone
(74) *Attorney, Agent, or Firm* — Marshall A. Lerner; Marvin H. Kleinberg; Kleinberg & Lerner, LLP

(57) **CLAIM**
The ornamental design for a shoe upper, as shown and described.

DESCRIPTION

FIG. 1 is a perspective view of a first exemplary embodiment of a shoe upper in accordance with my new design.
FIG. 2 is a left side view thereof;
FIG. 3 is a right side view thereof;
FIG. 4 is a top plan view thereof;
FIG. 5 is a bottom plan view thereof;
FIG. 6 is a rear elevation view thereof and
FIG. 7 is a front elevation view thereof.
FIG. 8 is a perspective view of a second exemplary embodiment of a shoe upper in accordance with my new design.
FIG. 9 is a left side view thereof;
FIG. 10 is a right side view thereof;
FIG. 11 is a top plan view thereof;
FIG. 12 is a bottom plan view thereof;
FIG. 13 is a rear elevation view thereof; and,
FIG. 14 is a front elevation view thereof.
Broken lines showing the remainder of the shoe in the figures are for illustrative purposes only and form no part of the claimed invention.

1 Claim, 12 Drawing Sheets

- (56) **References Cited**
U.S. PATENT DOCUMENTS
- | | | | |
|--------------|---------|------------------|--------|
| D94,108 S * | 12/1934 | Bancroft | D2/974 |
| D107,676 S * | 12/1937 | Cook | D2/923 |
| D146,423 S * | 2/1947 | Von Baudissin | D2/923 |
| D153,256 S * | 4/1949 | Braga | D2/923 |
| D170,782 S | 11/1953 | Wegner | |
| 186,155 A | 9/1959 | Bianchini | |
| D366,953 S | 2/1996 | Tate | |
| D432,772 S * | 10/2000 | Debiase | D2/972 |
| D432,773 S * | 10/2000 | Debiase | D2/972 |
| D442,771 S | 5/2001 | Haas | |
| D451,262 S * | 12/2001 | Ransan | D2/923 |
| D452,369 S * | 12/2001 | Roulo | D2/973 |
| D457,296 S | 5/2002 | Burt | |
| D459,868 S * | 7/2002 | McCourt | D2/972 |
| D467,063 S | 12/2002 | Chen | |
| D474,006 S * | 5/2003 | Schroeder et al. | D2/969 |
| D474,009 S * | 5/2003 | Lotti | D2/972 |

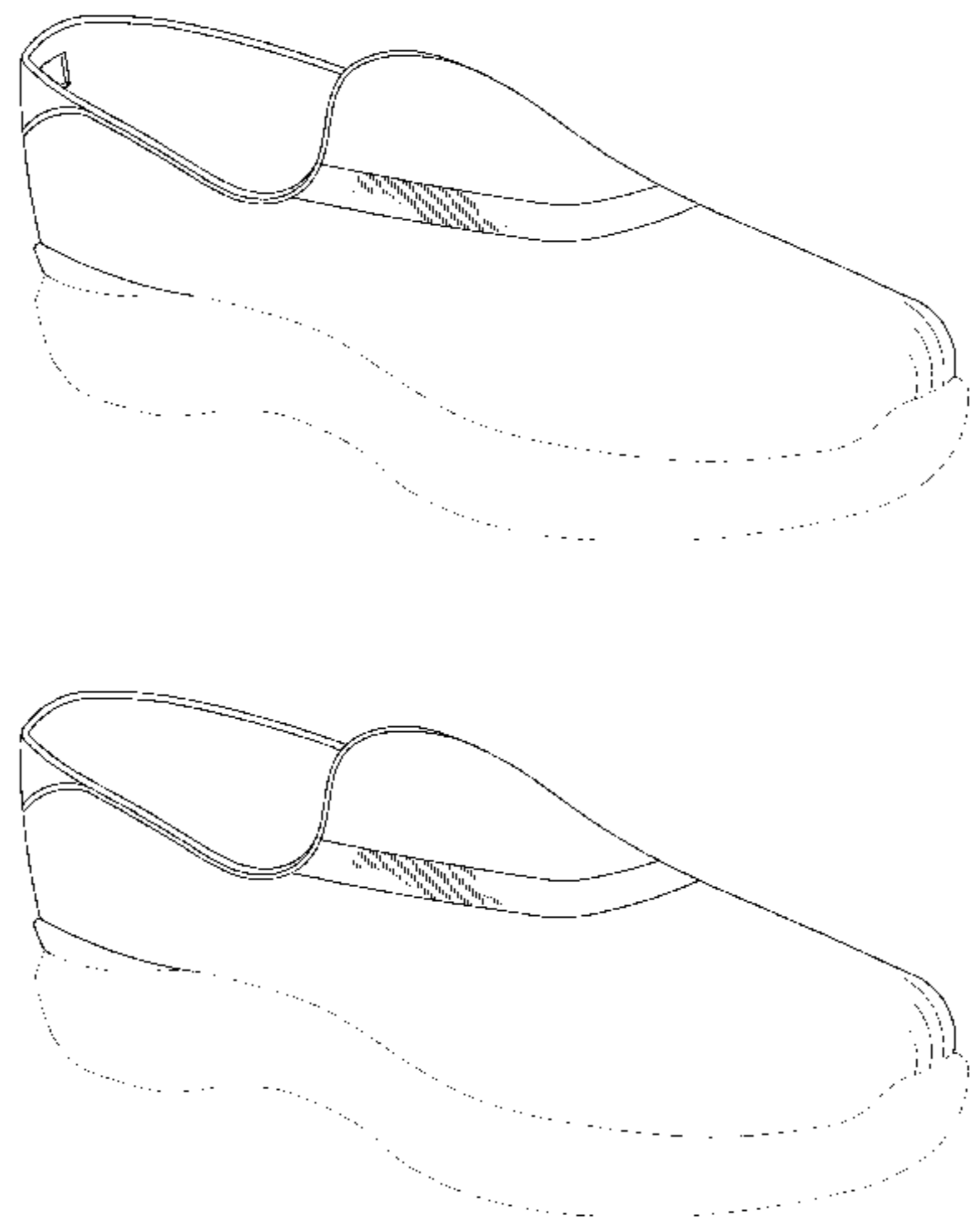

(56)

References Cited

U.S. PATENT DOCUMENTS

D523,615 S	6/2006	Burg	
D529,706 S *	10/2006	Paz	D2/972
D532,590 S	11/2006	Belley et al.	
D533,339 S *	12/2006	Edwards	D2/972
D544,700 S	6/2007	Link	
D546,042 S *	7/2007	Matis	D2/969
D549,441 S *	8/2007	Chang	D2/972
D550,947 S *	9/2007	Caine	D2/972
D553,838 S	10/2007	Belley et al.	
D556,994 S *	12/2007	Belley	D2/969
D564,210 S *	3/2008	Minami	D2/972
D566,948 S *	4/2008	Belley et al.	D2/969
D578,294 S	10/2008	Mervar et al.	
D605,388 S	12/2009	St-Louis et al.	
D611,239 S *	3/2010	Brambilla	D2/969
D613,485 S *	4/2010	Meador	D2/926
D653,020 S	1/2012	Van Zyll De Jong et al.	
D654,255 S	2/2012	Amzallag	
D659,989 S *	5/2012	Caine	D2/972
D660,581 S *	5/2012	Caine	D2/972
D661,884 S *	6/2012	Raysse	D2/969
D668,441 S	10/2012	Shaffer	
D668,858 S	10/2012	Shaffer	
D676,223 S	2/2013	Dill	
D682,530 S	5/2013	Wilken	
D687,622 S	8/2013	Tzenos et al.	
D689,681 S	9/2013	Dekovic	
D694,504 S *	12/2013	McMillan	D2/971

* cited by examiner

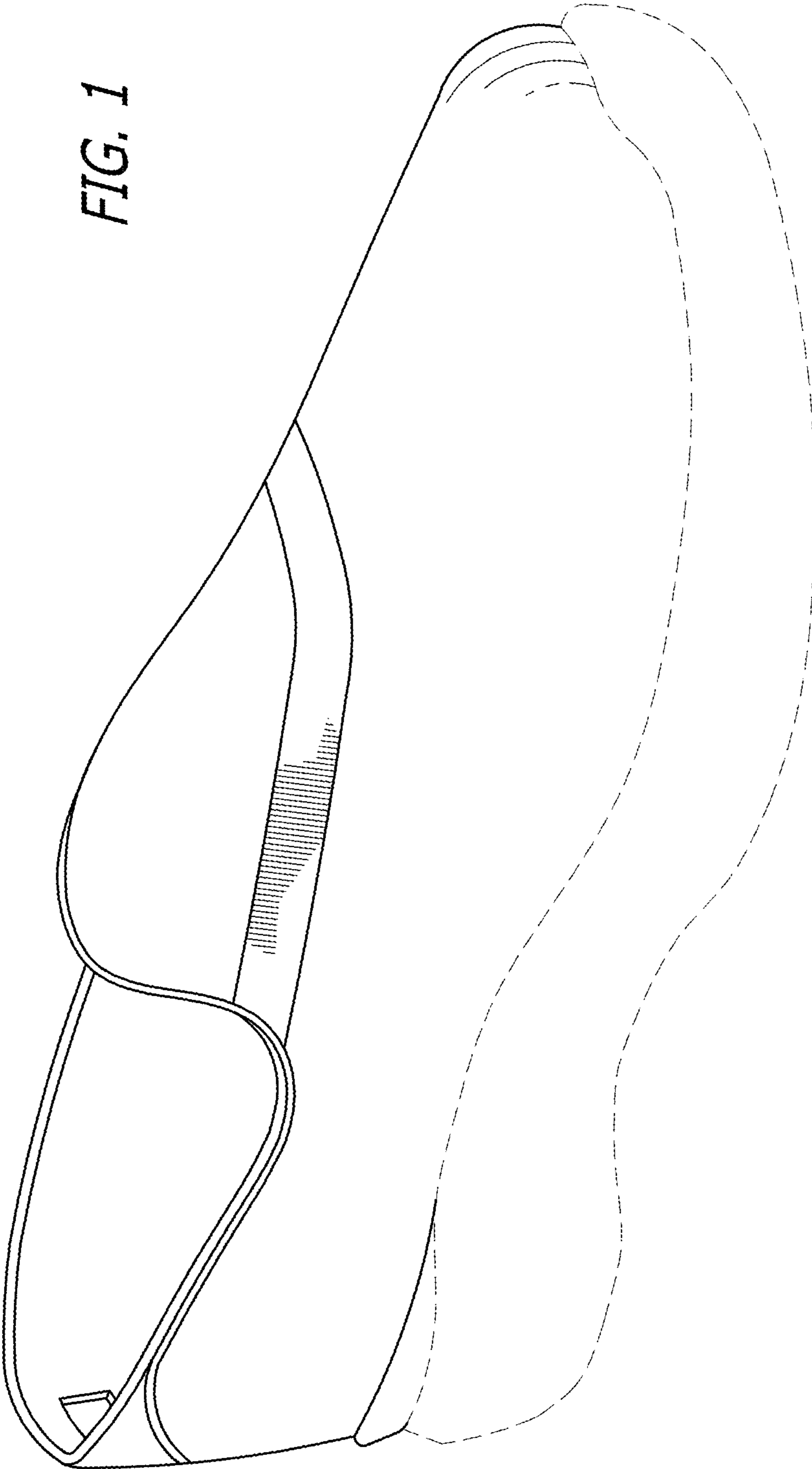

FIG. 1

FIG. 2

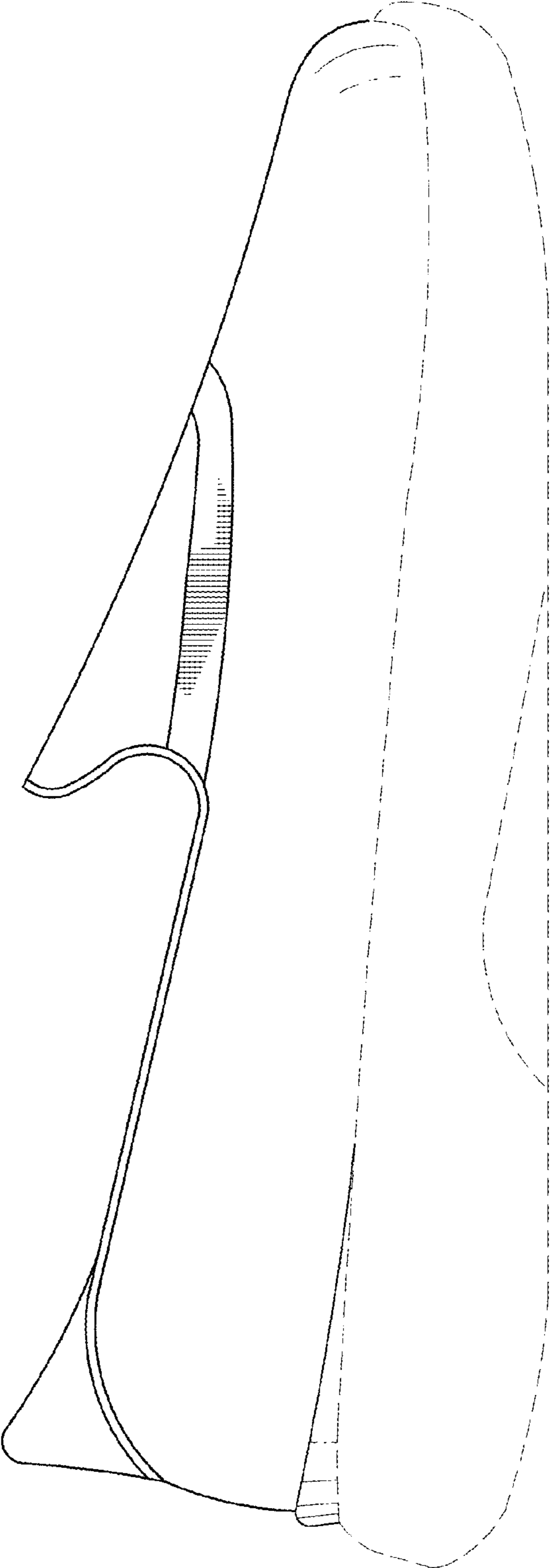
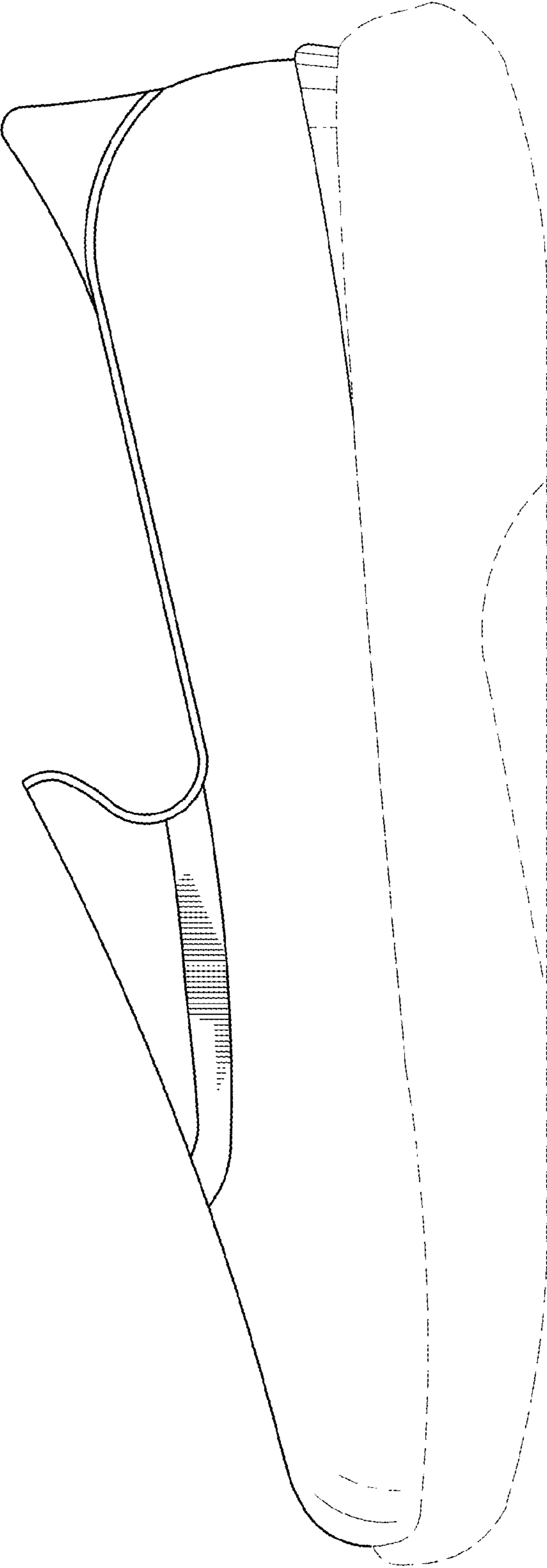

FIG. 3



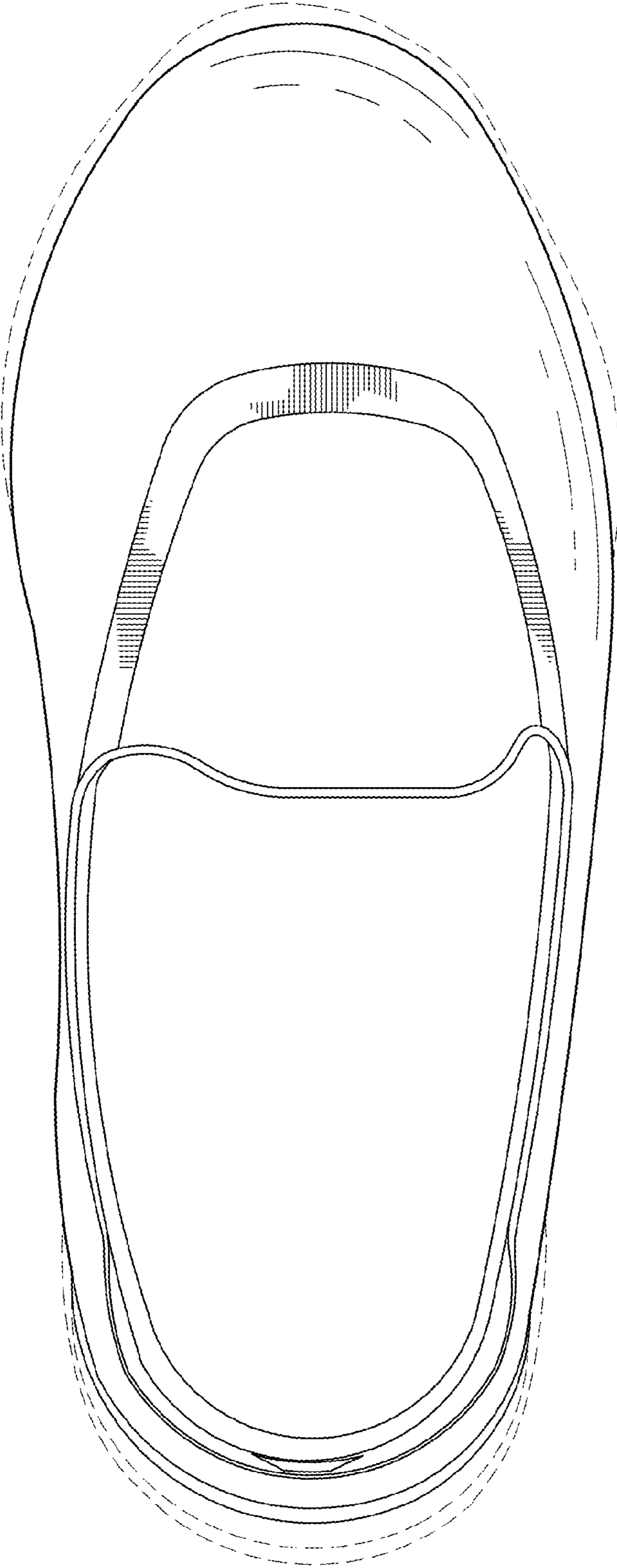

FIG. 4

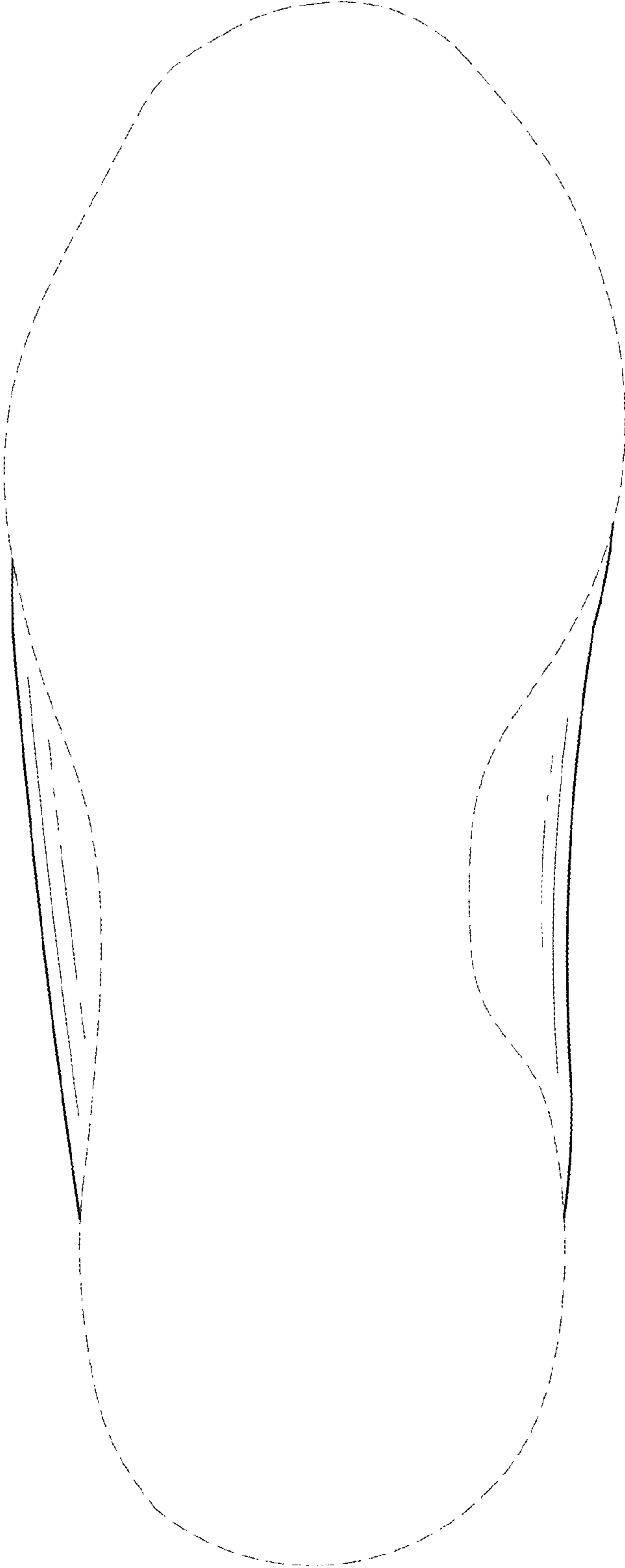

FIG. 5

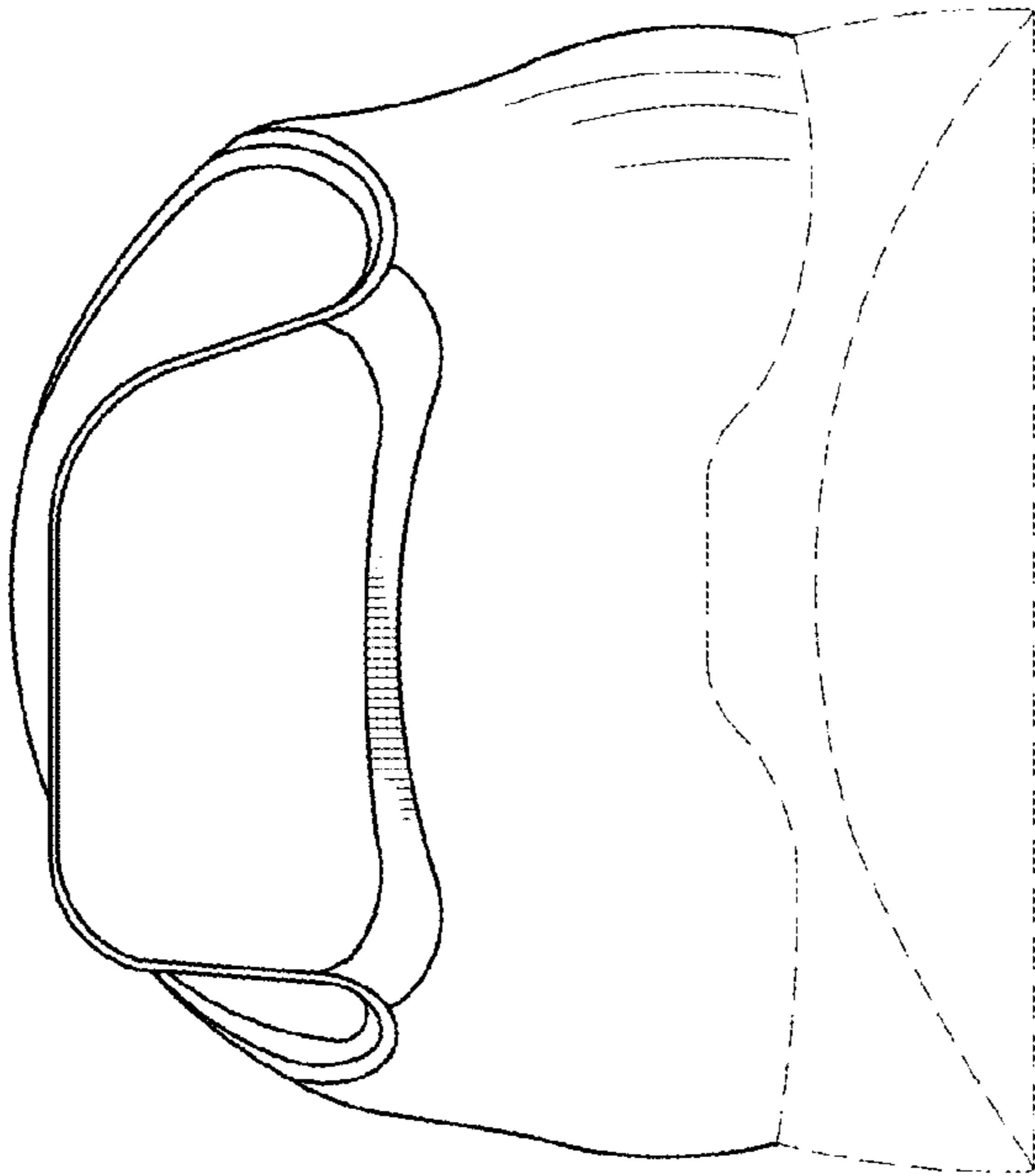

FIG. 6

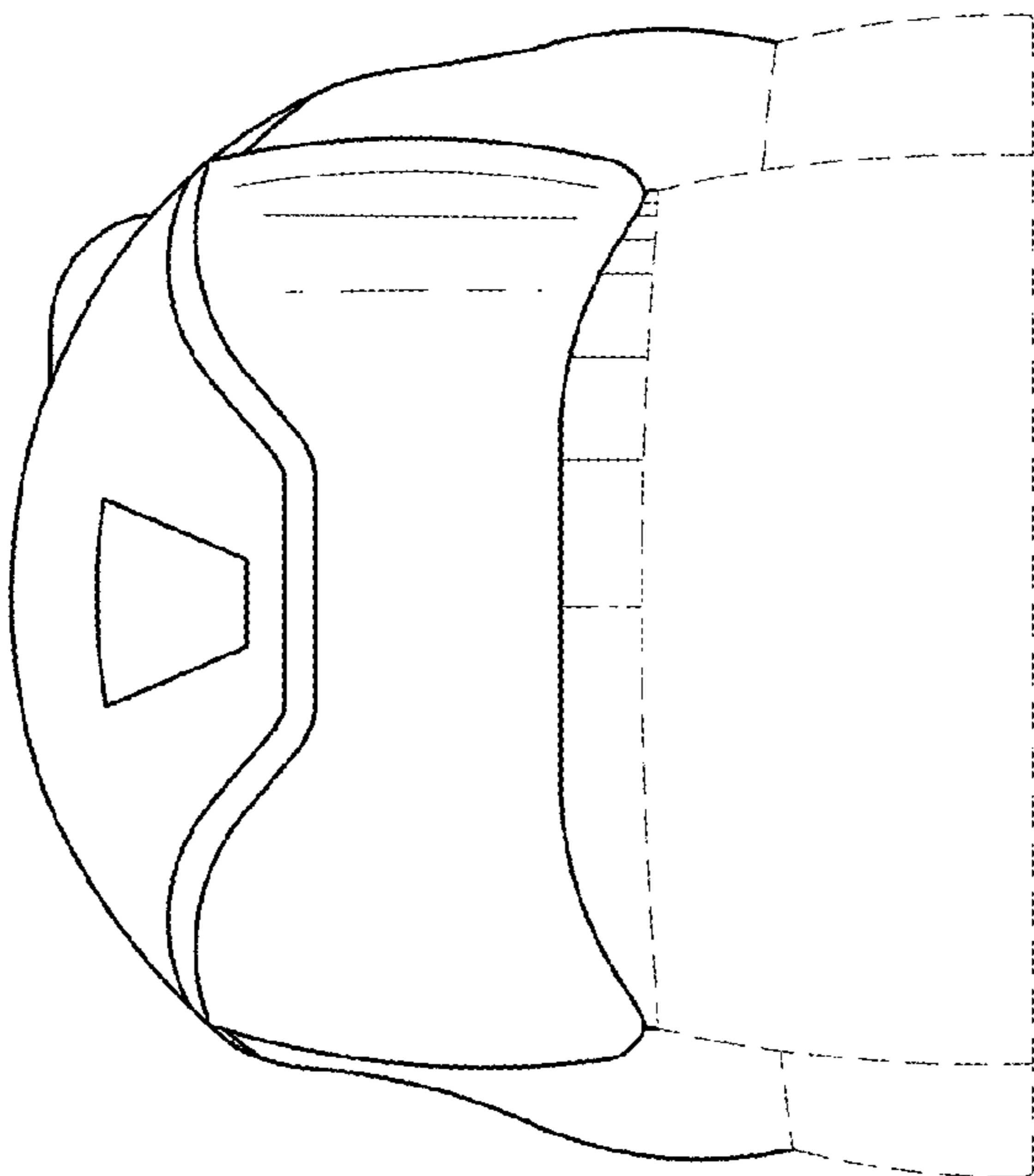

FIG. 7

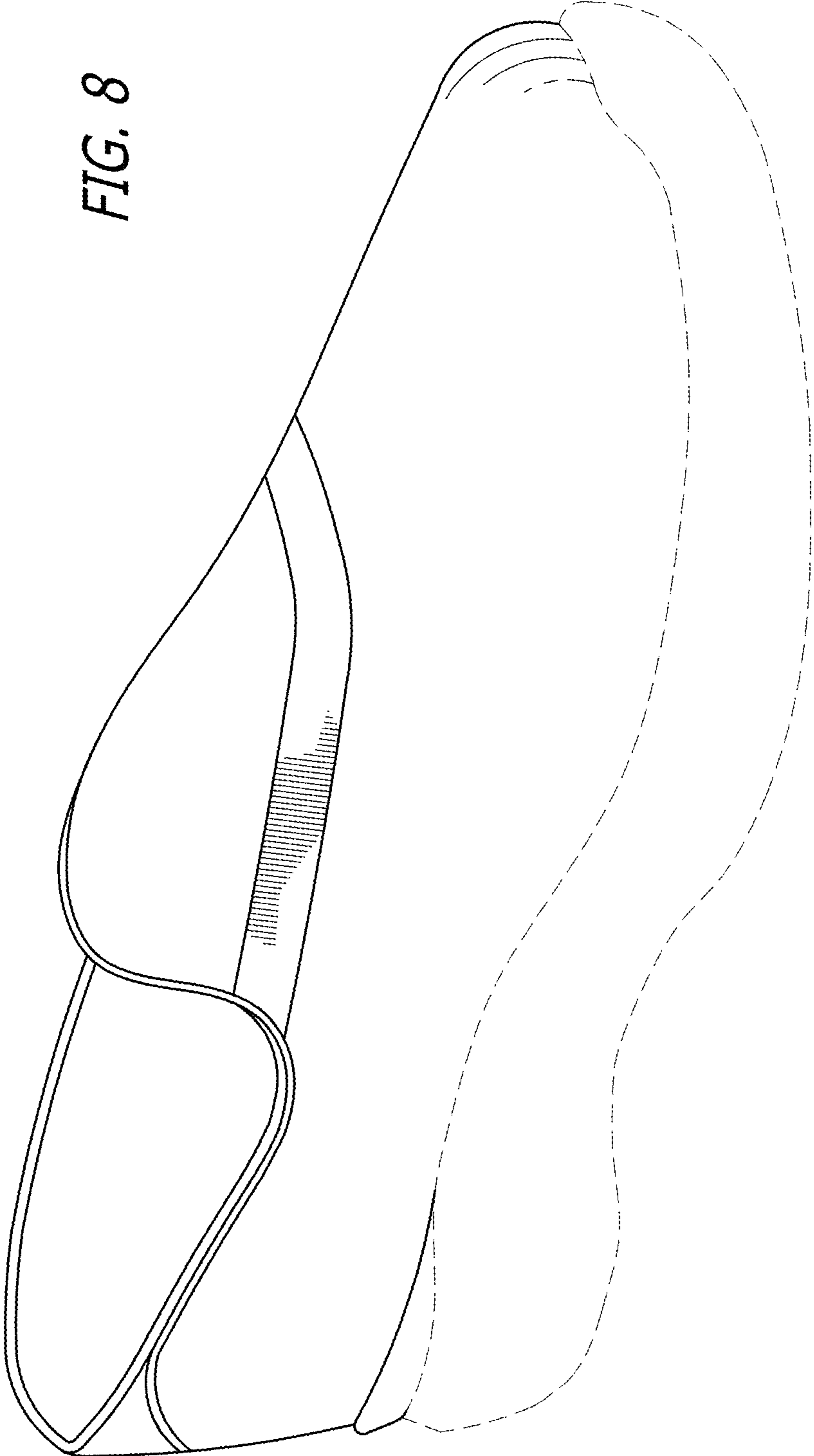
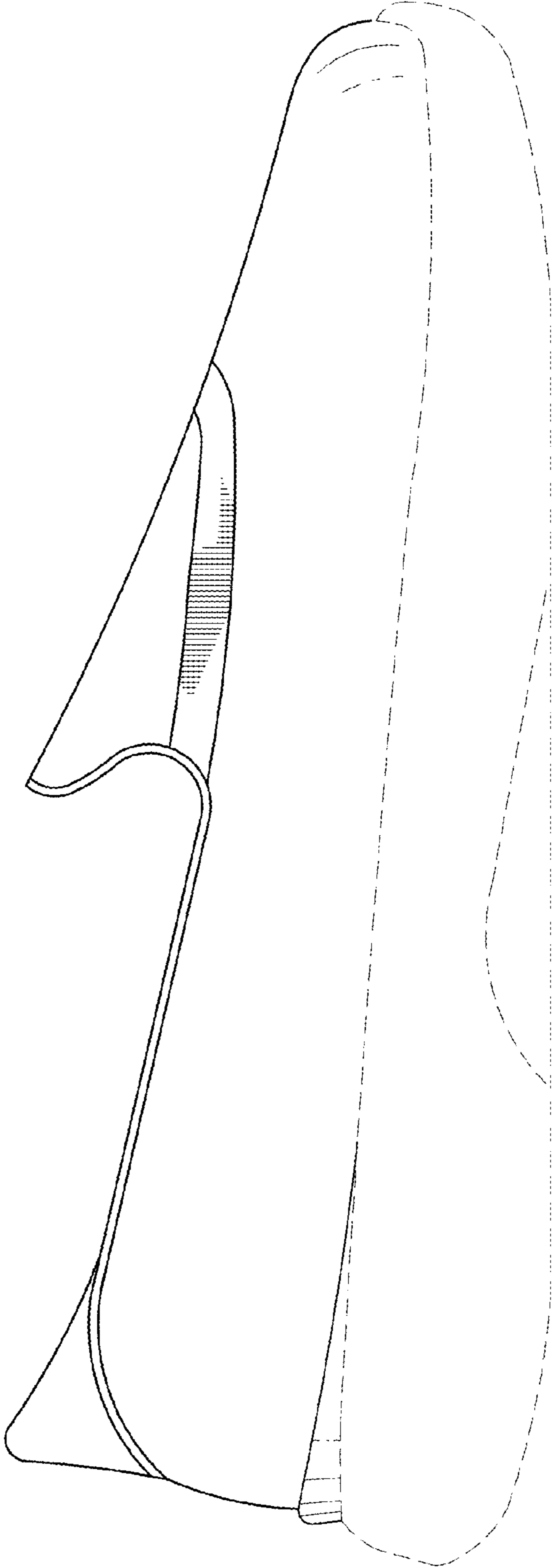

FIG. 9



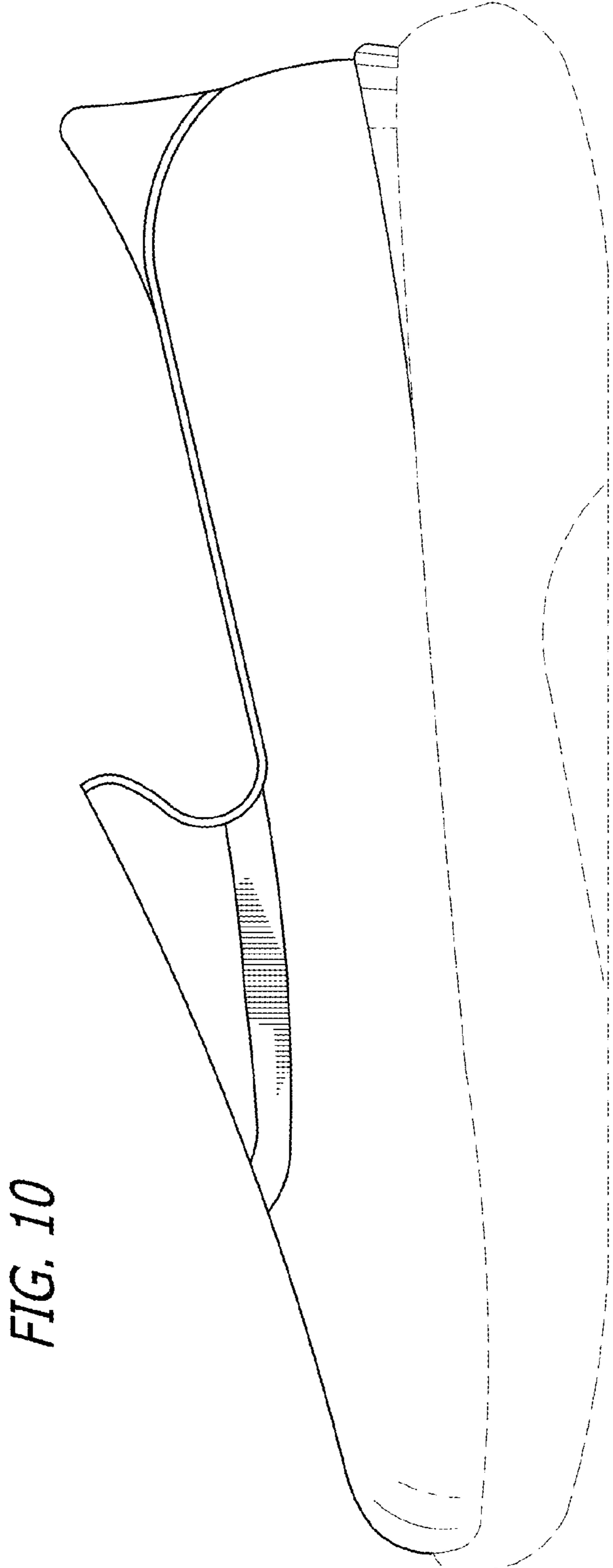

FIG. 10

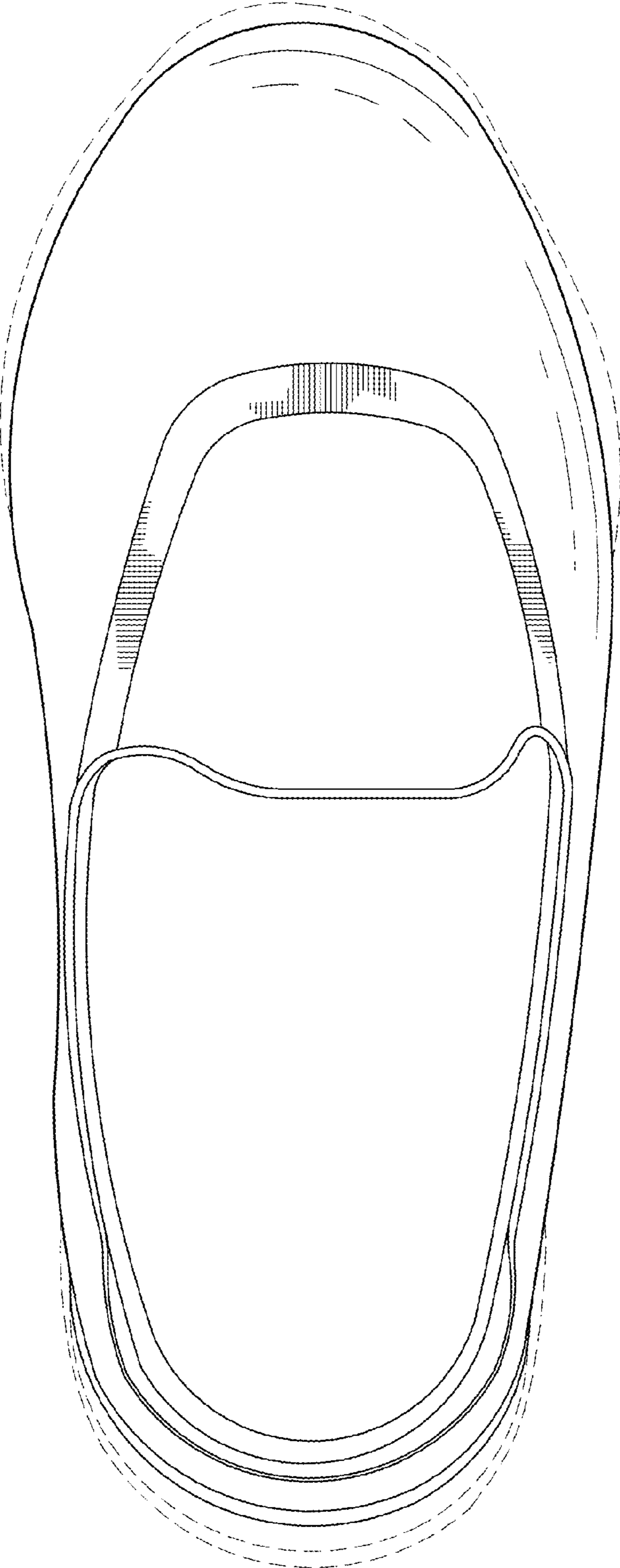

FIG. 11

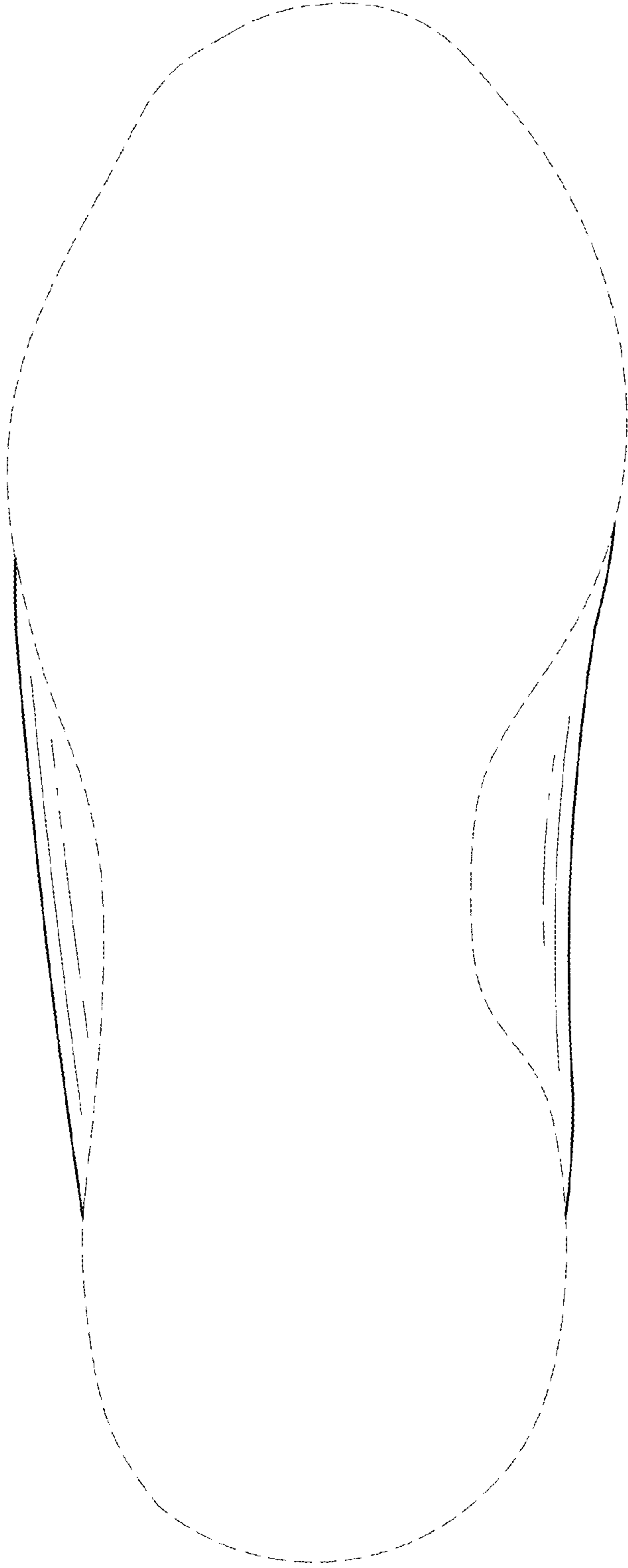

FIG. 12

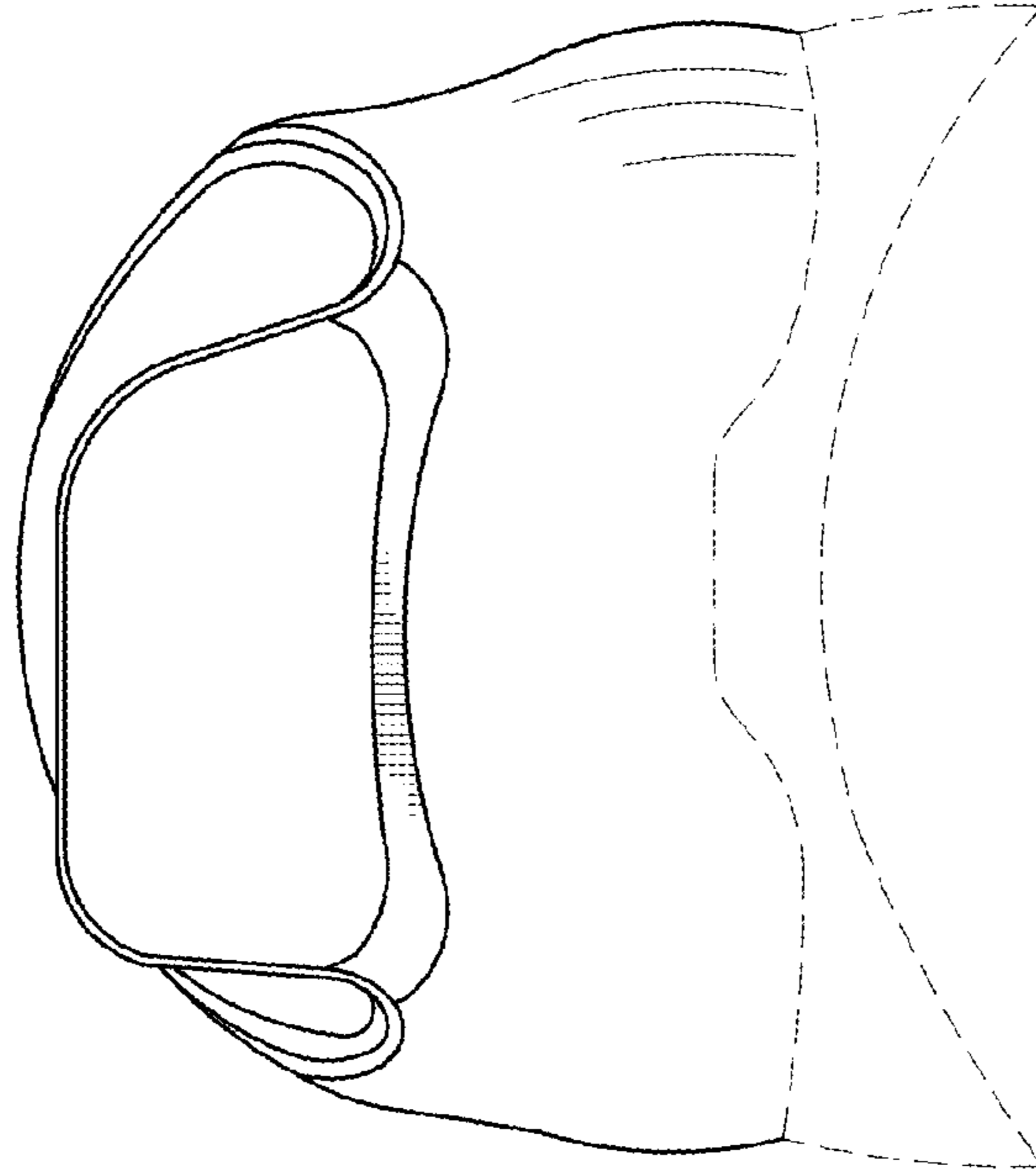

FIG. 13

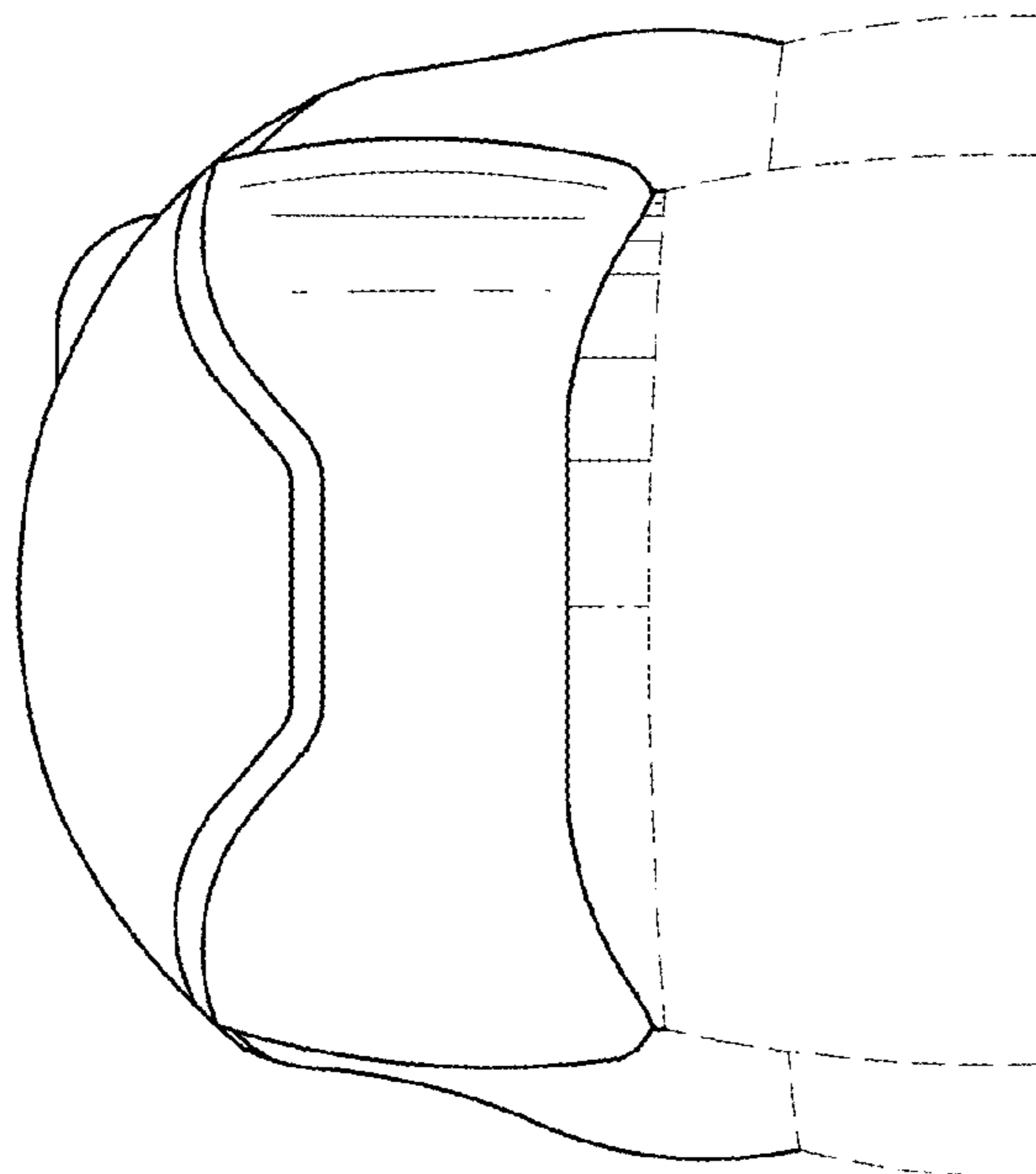

FIG. 14