



US00D723706S

(12) **United States Design Patent**  
**Larsen et al.**

(10) **Patent No.:** **US D723,706 S**  
(45) **Date of Patent:** **\*\* Mar. 3, 2015**

(54) **SPA SHELL**  
(71) Applicant: **Watkins Manufacturing Corporation,**  
Vista, CA (US)  
(72) Inventors: **Christopher Carl Larsen,** Vista, CA  
(US); **Sage Nathan Baker,** Cardiff By  
The Sea, CA (US)  
(73) Assignee: **Watkins Manufacturing Corporation,**  
Vista, CA (US)

D624,657 S \* 9/2010 Larsen et al. .... D24/204  
D634,019 S \* 3/2011 Larsen et al. .... D24/204  
D634,021 S \* 3/2011 Larsen et al. .... D24/204  
D649,256 S \* 11/2011 Larsen et al. .... D24/204  
D657,881 S \* 4/2012 Larsen et al. .... D24/204  
D657,882 S \* 4/2012 Larsen et al. .... D24/204  
D657,883 S \* 4/2012 Larsen et al. .... D24/204  
D680,656 S \* 4/2013 Larsen et al. .... D24/204  
D683,038 S \* 5/2013 Larsen et al. .... D24/204  
D683,039 S \* 5/2013 Larsen et al. .... D24/204

(\*\*) Term: **14 Years**

\* cited by examiner

*Primary Examiner* — David Muller

(74) *Attorney, Agent, or Firm* — Kirk W. Rudolph

(21) Appl. No.: **29/477,474**

(22) Filed: **Dec. 23, 2013**

(51) **LOC (10) Cl.** ..... **23-02**

(52) **U.S. Cl.**  
USPC ..... **D24/204**

(58) **Field of Classification Search**  
USPC ..... D24/201, 204, 205; D23/277, 278, 276,  
D23/280.1–280.3; 601/154–158;  
4/541.1–541.6, 547, 578.1, 579  
See application file for complete search history.

(57) **CLAIM**

The ornamental design for a spa shell, as shown and described.

**DESCRIPTION**

FIG. 1 is a perspective view of a spa shell showing our design; FIG. 2 is a perspective view thereof; FIG. 3 is a top plan view thereof; FIG. 4 is a cross-sectional view taken along line 4-4 of FIG. 3; FIG. 5 is a cross-sectional view taken along line 5-5 of FIG. 3; FIG. 6 is a cross-sectional view taken along line 6-6 of FIG. 3; and, FIG. 7 is a cross-sectional view taken along line 7-7 of FIG. 3. The broken lines in the drawings represent unclaimed portions of the spa shell and form no part thereof.

(56) **References Cited**

U.S. PATENT DOCUMENTS

D542,925 S \* 5/2007 Larsen ..... D24/204  
D620,600 S \* 7/2010 Larsen et al. .... D24/204  
D621,947 S \* 8/2010 Larsen et al. .... D24/204

**1 Claim, 5 Drawing Sheets**

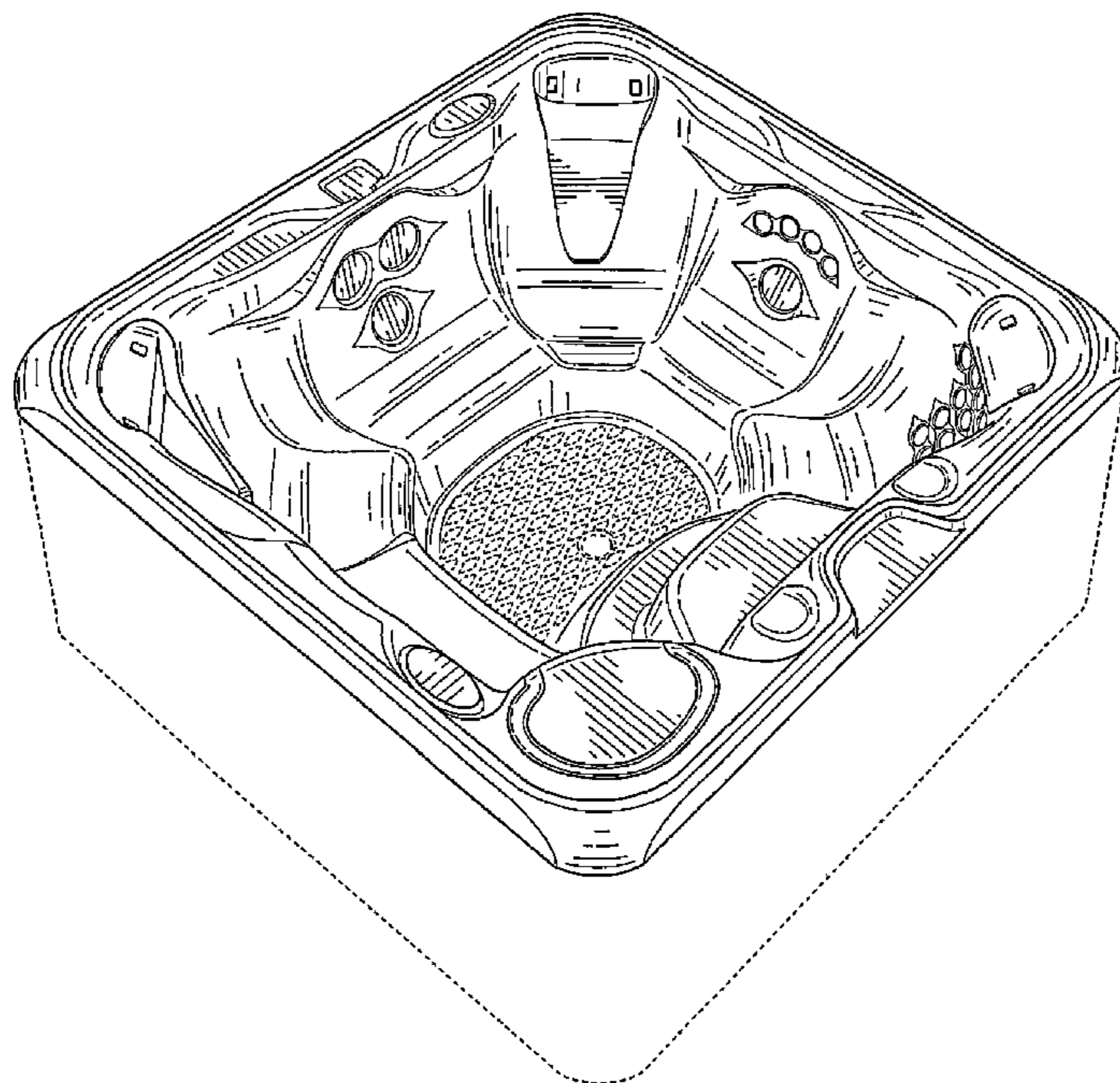

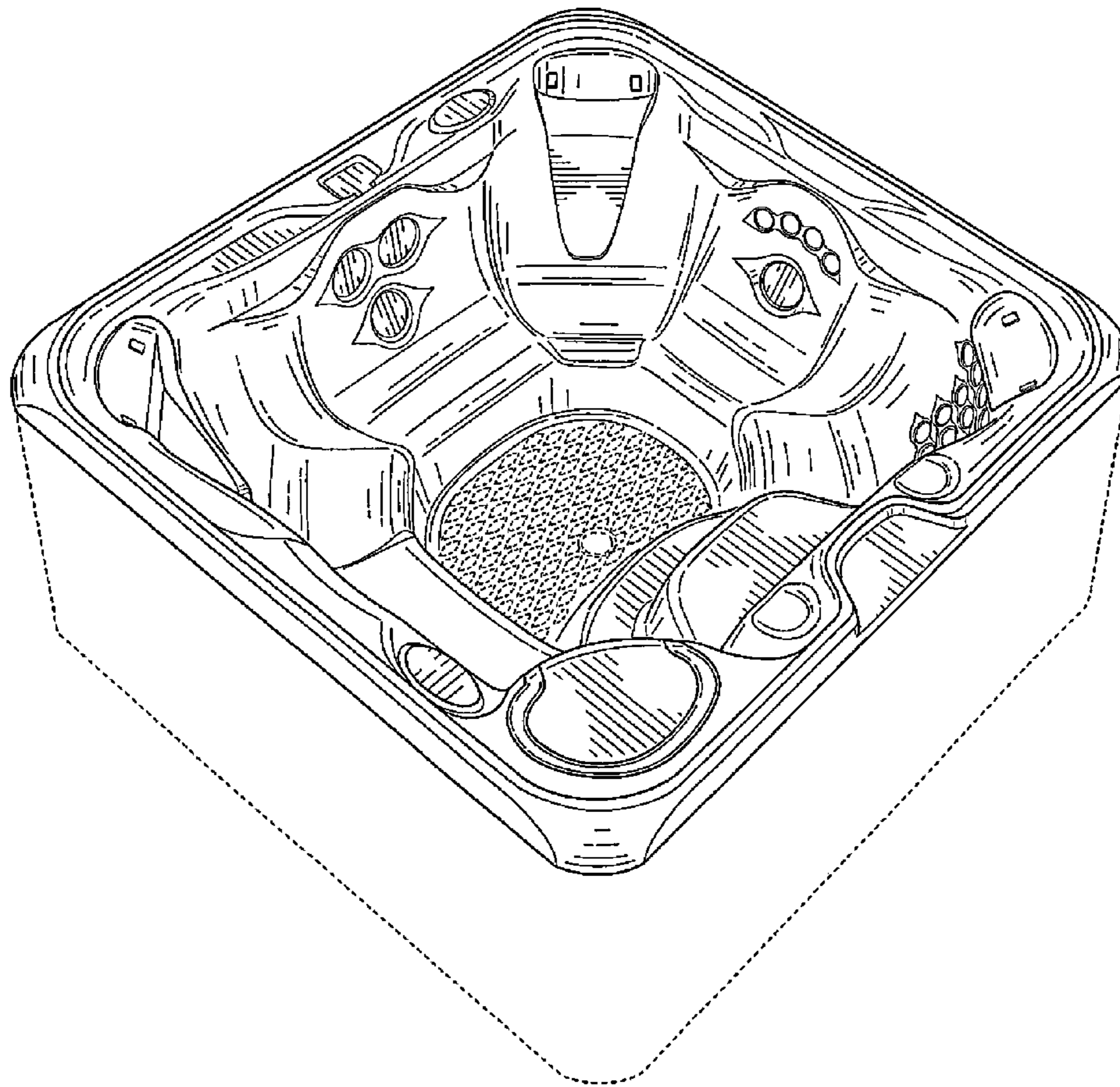

FIG. 1

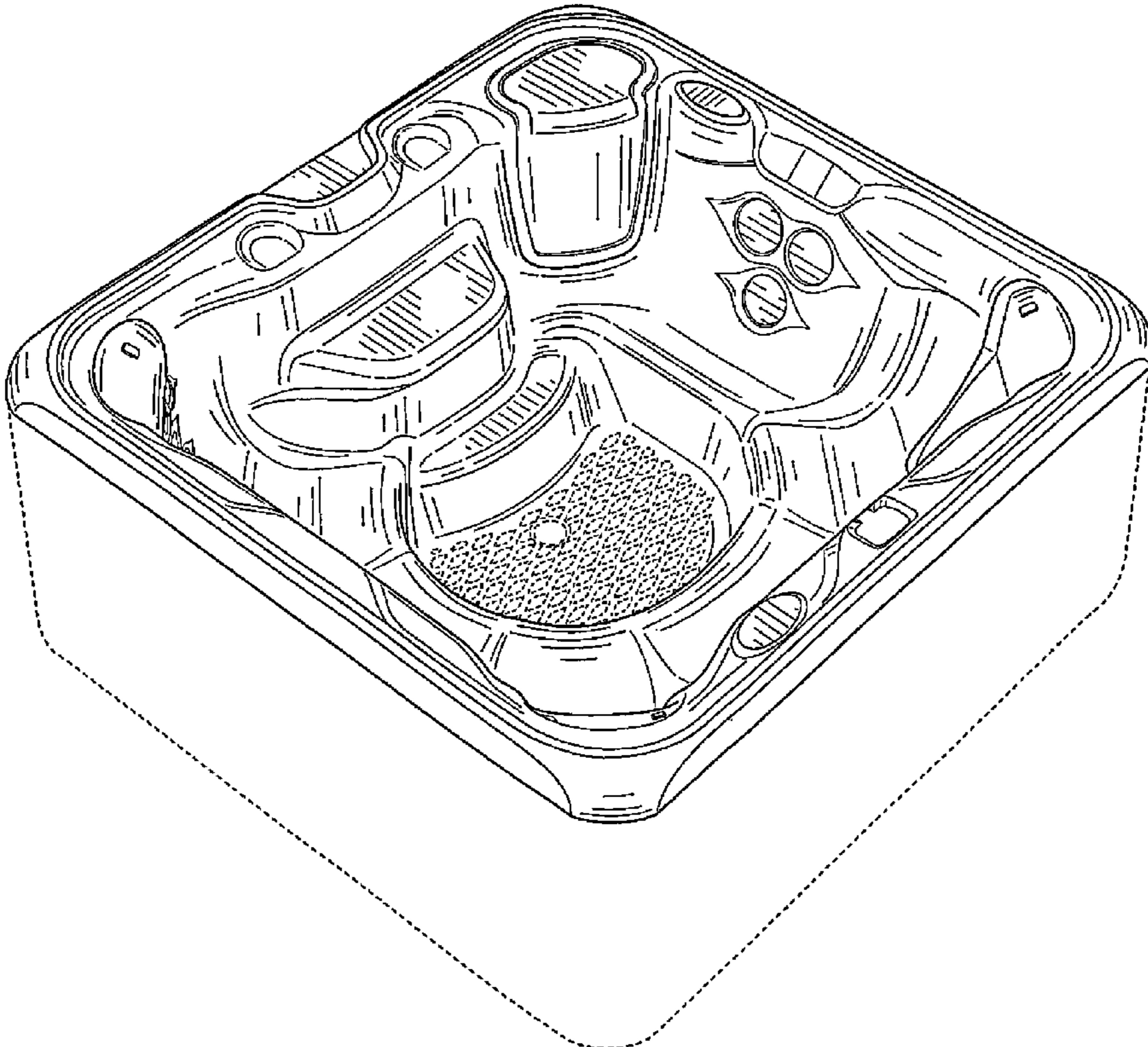

FIG. 2

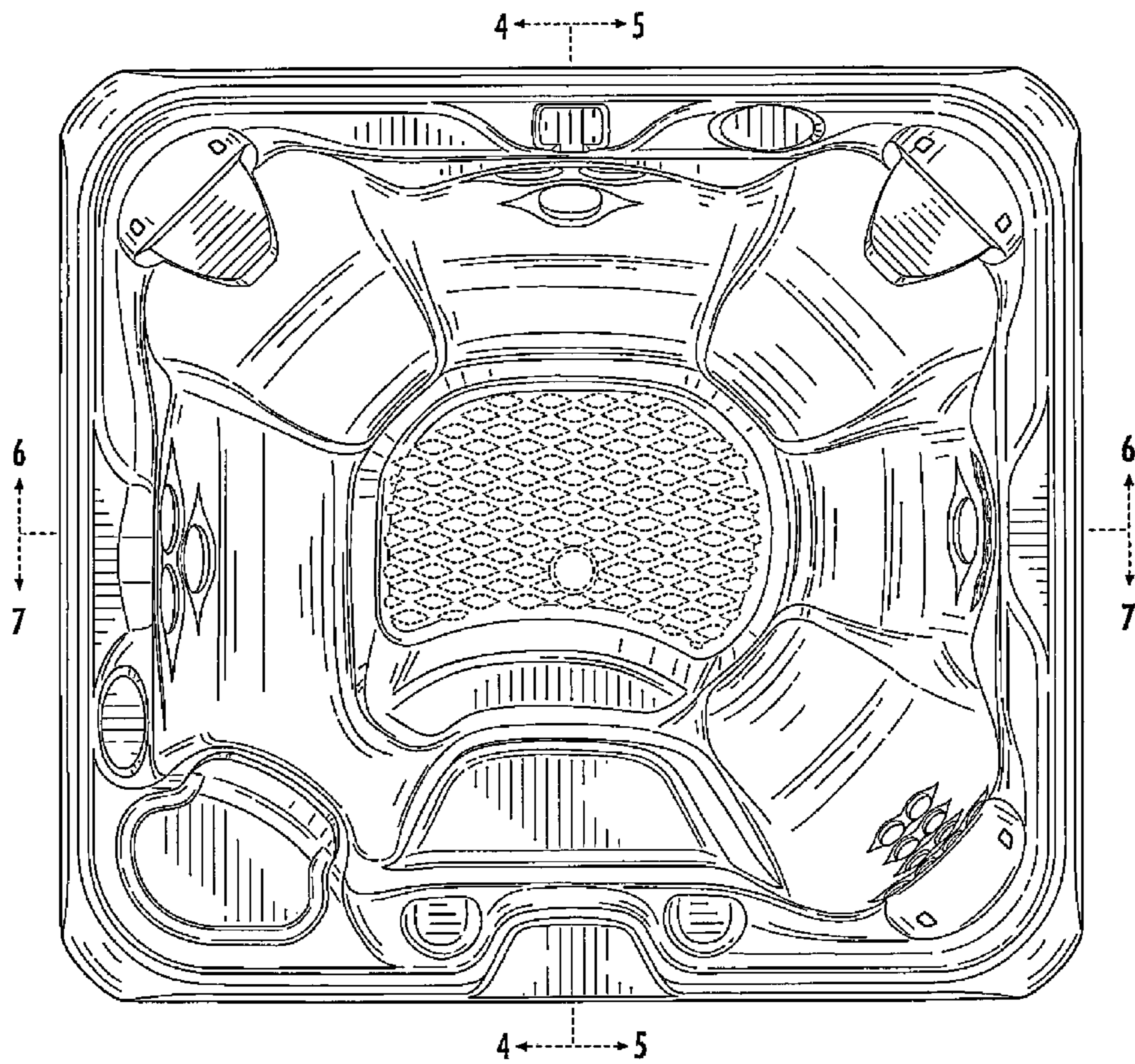

FIG. 3

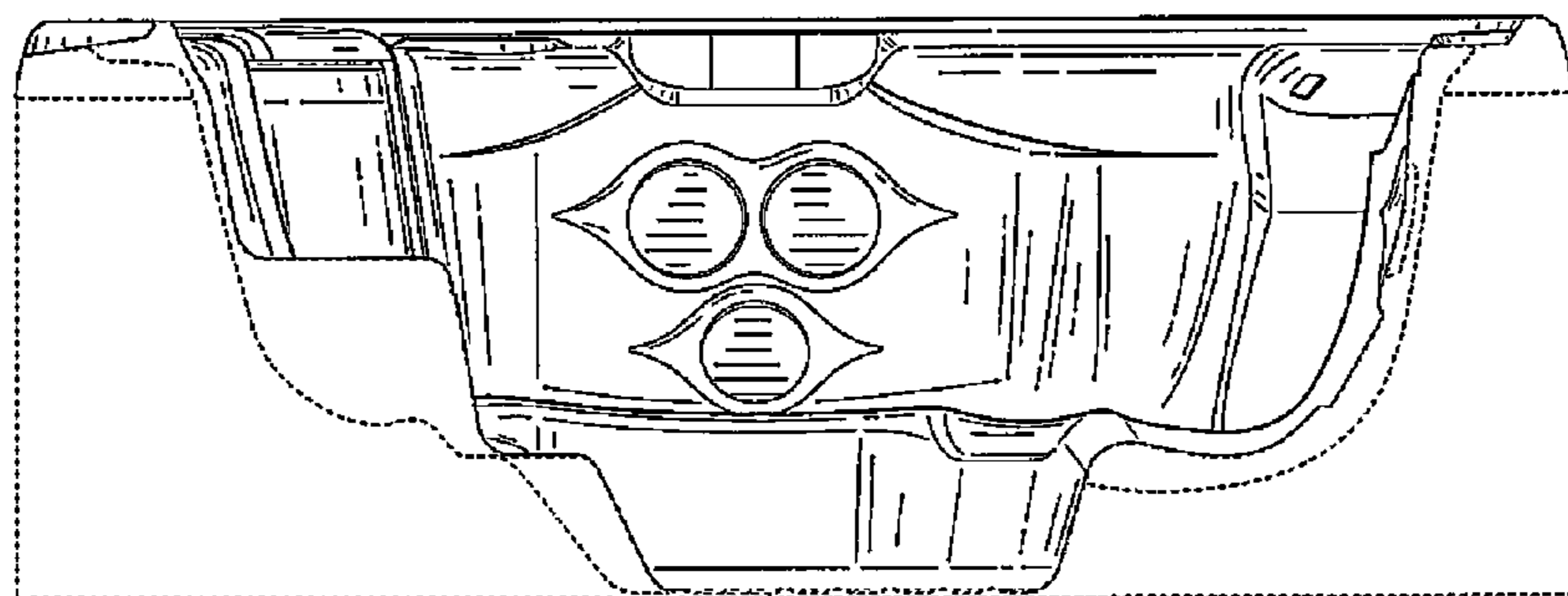

FIG. 4

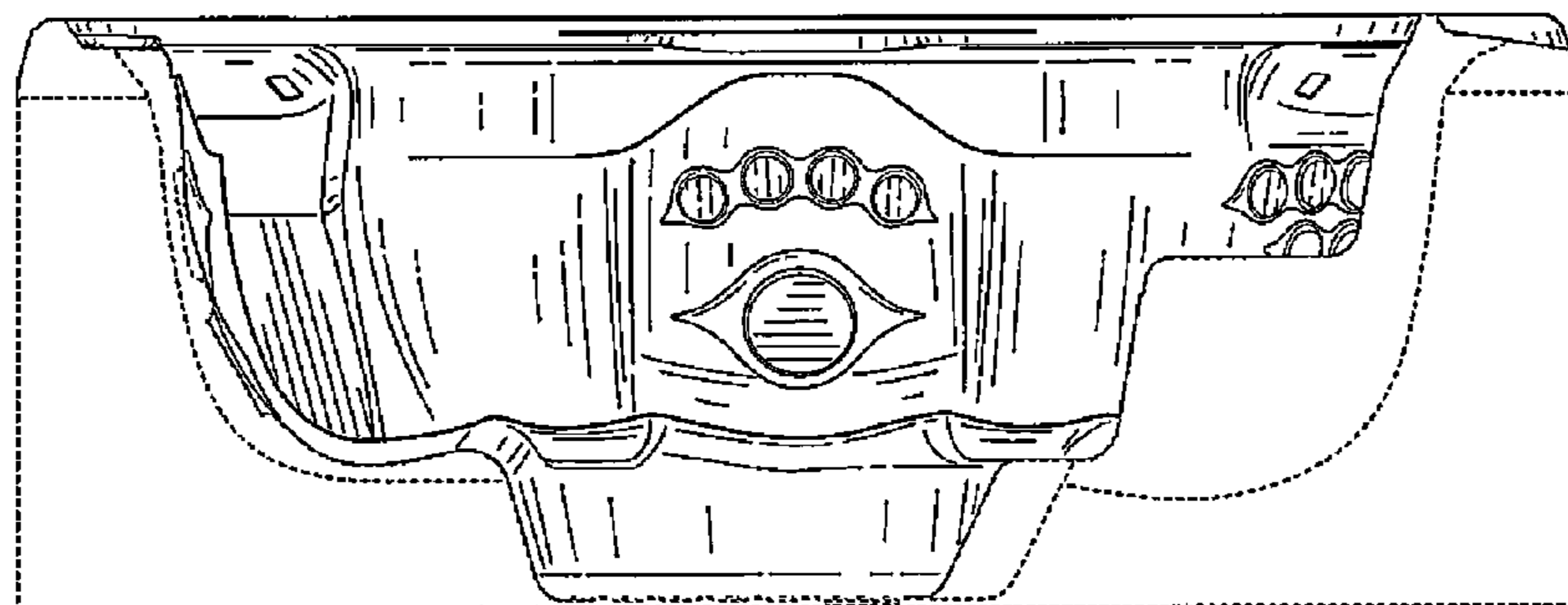

FIG. 5

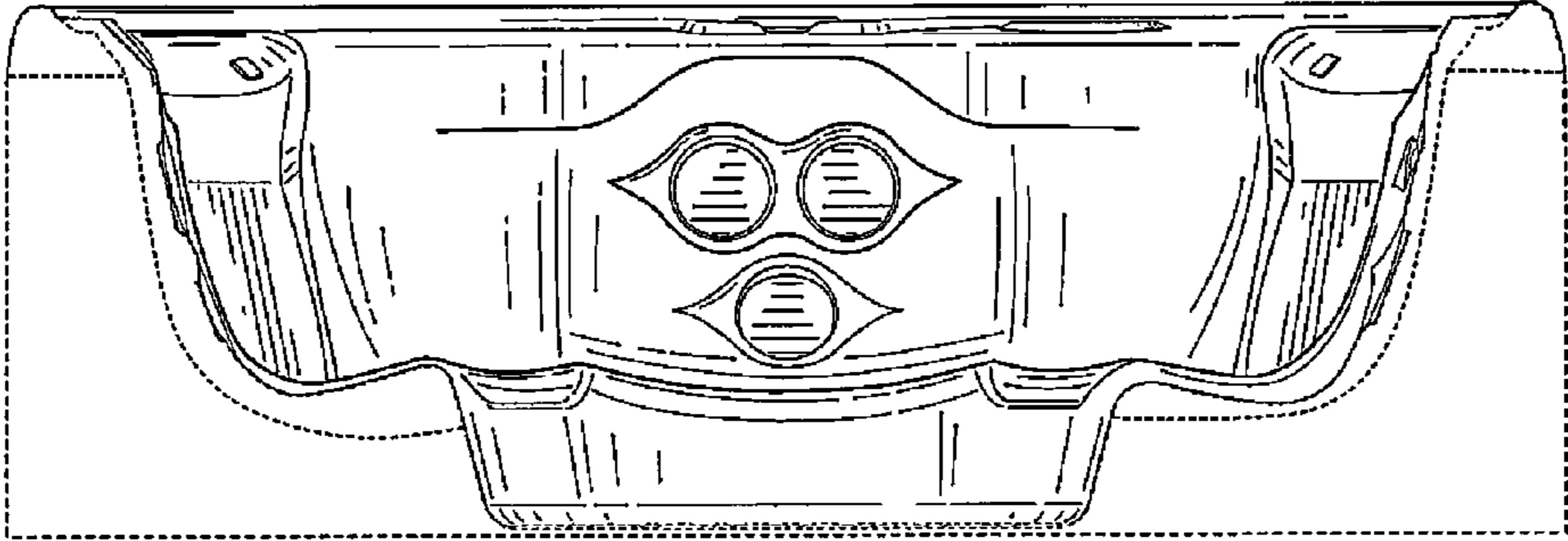

FIG. 6

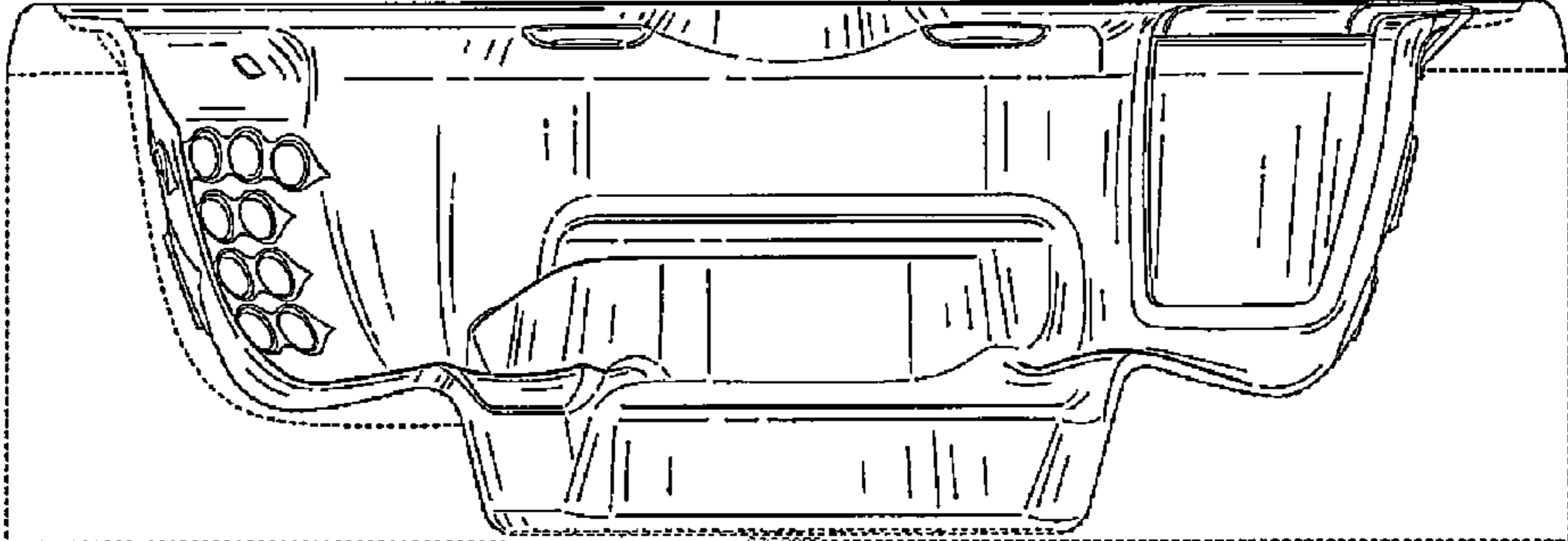

FIG. 7

UNITED STATES PATENT AND TRADEMARK OFFICE  
**CERTIFICATE OF CORRECTION**

PATENT NO. : D723,706 S  
APPLICATION NO. : 29/477474  
DATED : March 3, 2015  
INVENTOR(S) : Larsen et al.

Page 1 of 1

It is certified that error appears in the above-identified patent and that said Letters Patent is hereby corrected as shown below:

On the Title Page

Item [75], insert:

-- Fernando Pardo, Newbury Park, CA;  
Tim Dze-How Chuang, Encino, CA;  
Alexandra McGill, Los Angeles, CA;  
Martti Johannes Lampela, Woodland Hills, CA --

Signed and Sealed this  
Ninth Day of April, 2019

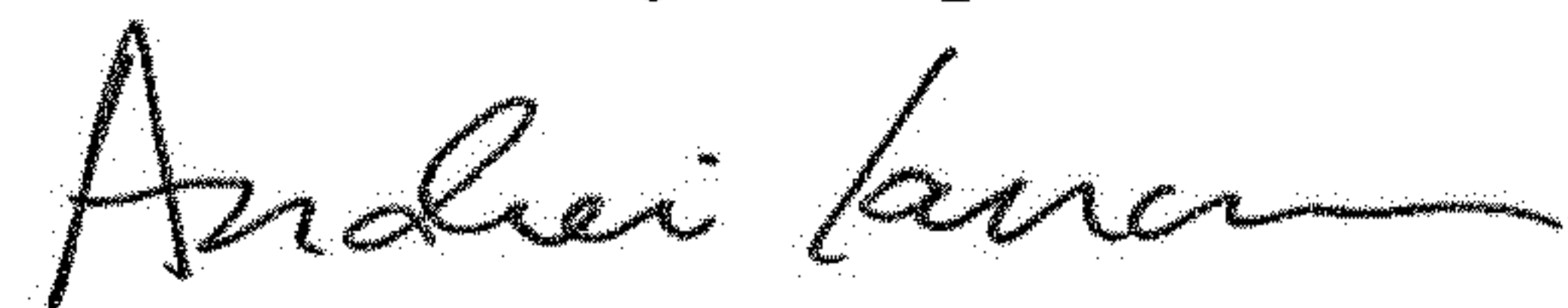

Andrei Iancu  
*Director of the United States Patent and Trademark Office*