



US00D723644S

(12) **United States Design Patent**  
**Alis**

(10) **Patent No.:** **US D723,644 S**  
(45) **Date of Patent:** **\*\* Mar. 3, 2015**

(54) **SUBMACHINE GUN**  
(71) Applicant: **Sarsilmaz Silah Sanayi A.S.**, Duzce (TR)  
(72) Inventor: **Latif Aral Alis**, Duzce (TR)  
(73) Assignee: **Sarsilmaz Silah Sanayi**, Duzce (TR)  
(\*\*) Term: **14 Years**

D297,855 S *	9/1988	Ruger et al.	.....	D22/108
D304,223 S *	10/1989	Ruger et al.	.....	D22/108
D614,717 S *	4/2010	Salva	.....	D22/108
7,716,864 B2 *	5/2010	Skrubis et al.	.....	42/71.01
D631,526 S *	1/2011	Torre et al.	.....	D22/108
D638,086 S *	5/2011	Salva	.....	D22/103
D671,182 S *	11/2012	Klotz	.....	D22/103
D678,453 S *	3/2013	Klotz	.....	D22/103
D679,356 S *	4/2013	Klotz	.....	D22/103
D692,514 S *	10/2013	Vera et al.	.....	D22/108

\* cited by examiner

(21) Appl. No.: **29/467,541**  
(22) Filed: **Sep. 20, 2013**  
(51) **LOC (10) Cl.** ..... **22-01**  
(52) **U.S. Cl.**  
USPC ..... **D22/103**  
(58) **Field of Classification Search**  
CPC ..... F41C 7/00; F41C 7/11; F41C 7/12  
USPC ..... D22/103; D21/572-575; 42/51, 71.01,  
42/75.01, 75.02, 90, 94, 134, 136, 139,  
42/125, 72, 111; 89/40.06, 41.19, 37.04,  
89/33.04, 191.01, 200-204; 124/67, 66,  
124/72, 74  
See application file for complete search history.

*Primary Examiner* — Michael A Pratt  
(74) *Attorney, Agent, or Firm* — Gokalp Bayramoglu

(57) **CLAIM**  
The ornamental design for a gun, as shown and described.

**DESCRIPTION**

FIG. 1 is a side view of the submachine gun  
FIG. 2 is a detail view of the shoulder pad of the submachine gun  
FIG. 3 is a detail view of cheek piece  
FIG. 4 is detail view of body and wrist plate  
FIG. 5 is detail view of body and receiver mount  
FIG. 6 is detail view of magazine cap  
FIG. 7 is detail view of muzzle sight ring  
FIG. 8 is side view of the submachine gun  
FIG. 9 is side view of the submachine gun  
FIG. 10 is side view of the submachine gun; and,  
FIG. 11 is side view of the submachine gun.

(56) **References Cited**  
U.S. PATENT DOCUMENTS  
D201,281 S \* 6/1965 Beck ..... D22/103  
D241,836 S \* 10/1976 Ruger ..... D22/103  
D272,173 S \* 1/1984 Mattarelli ..... D22/103  
D295,545 S \* 5/1988 Bell ..... D22/103

**1 Claim, 7 Drawing Sheets**

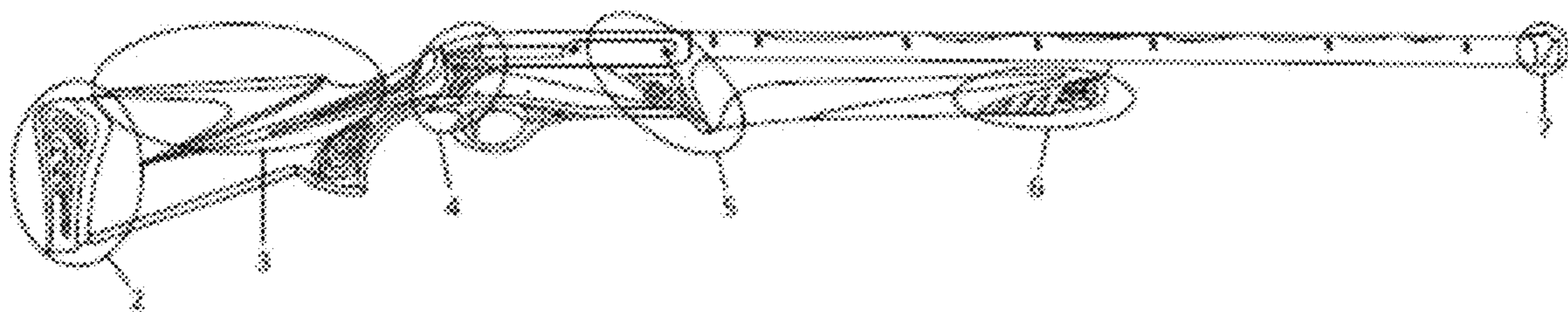

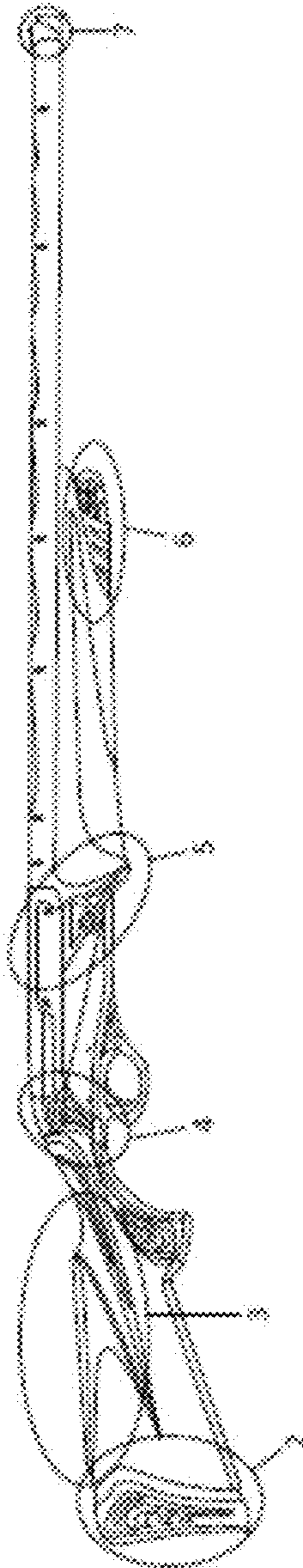

FIG. 1

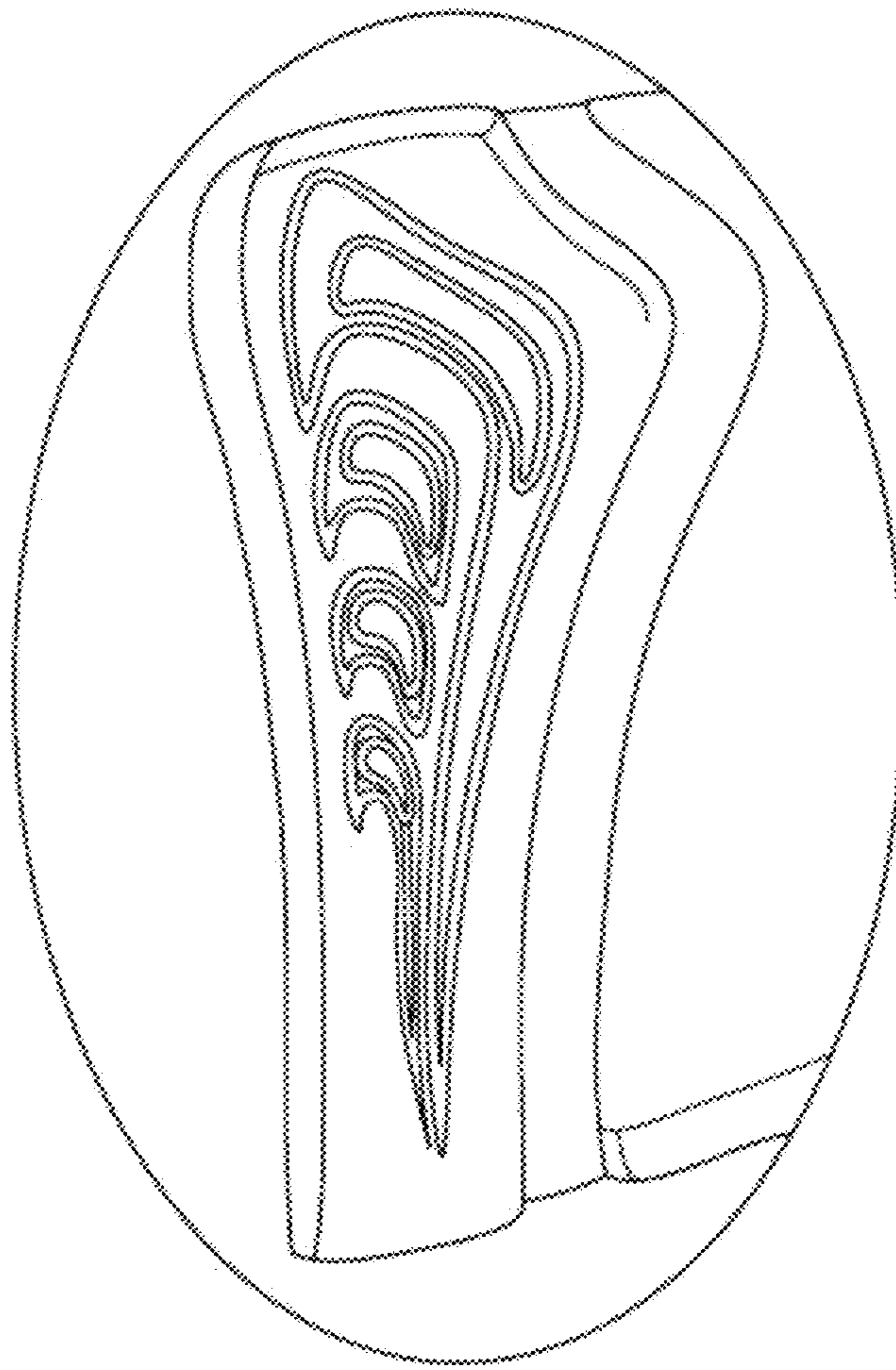

FIG. 2

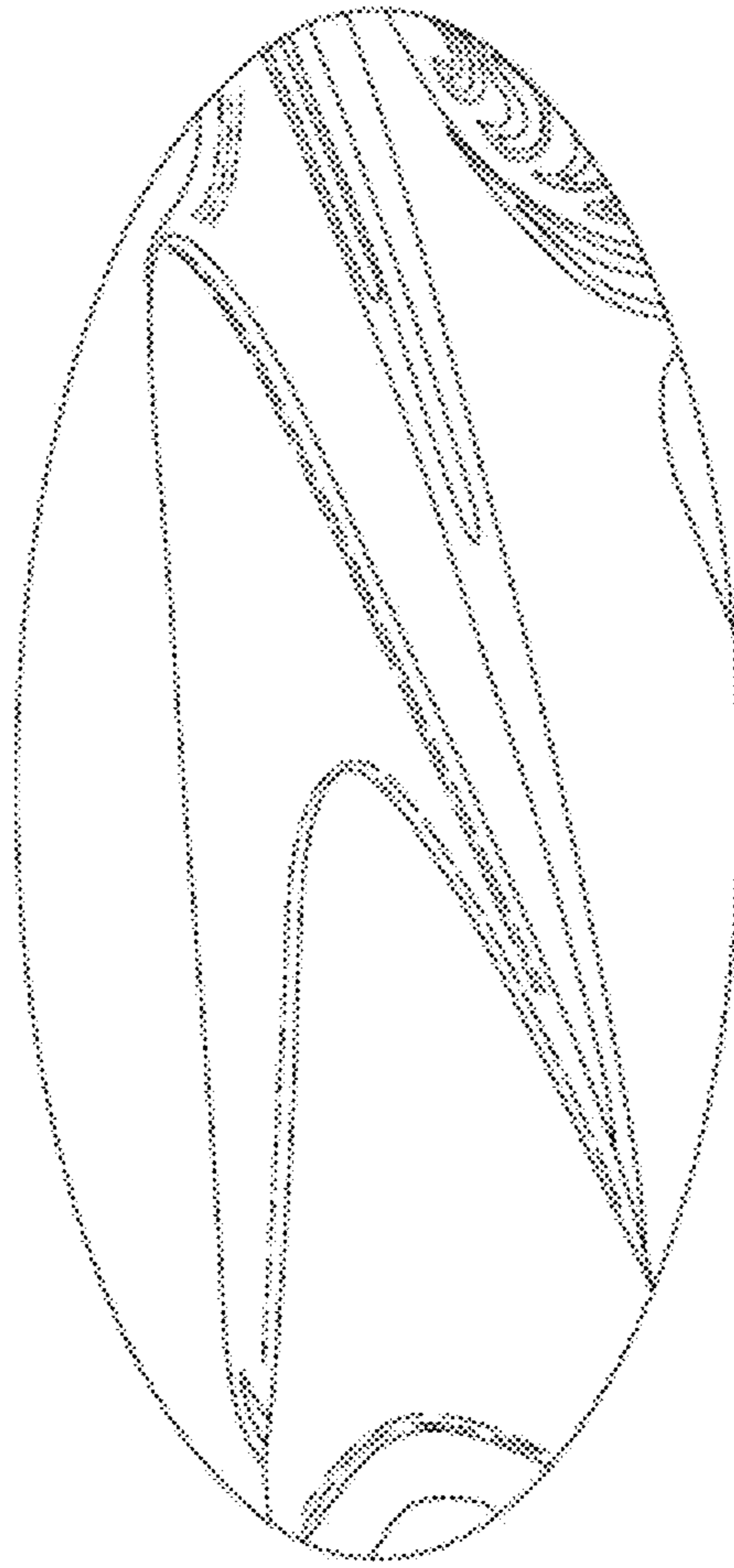

FIG. 3

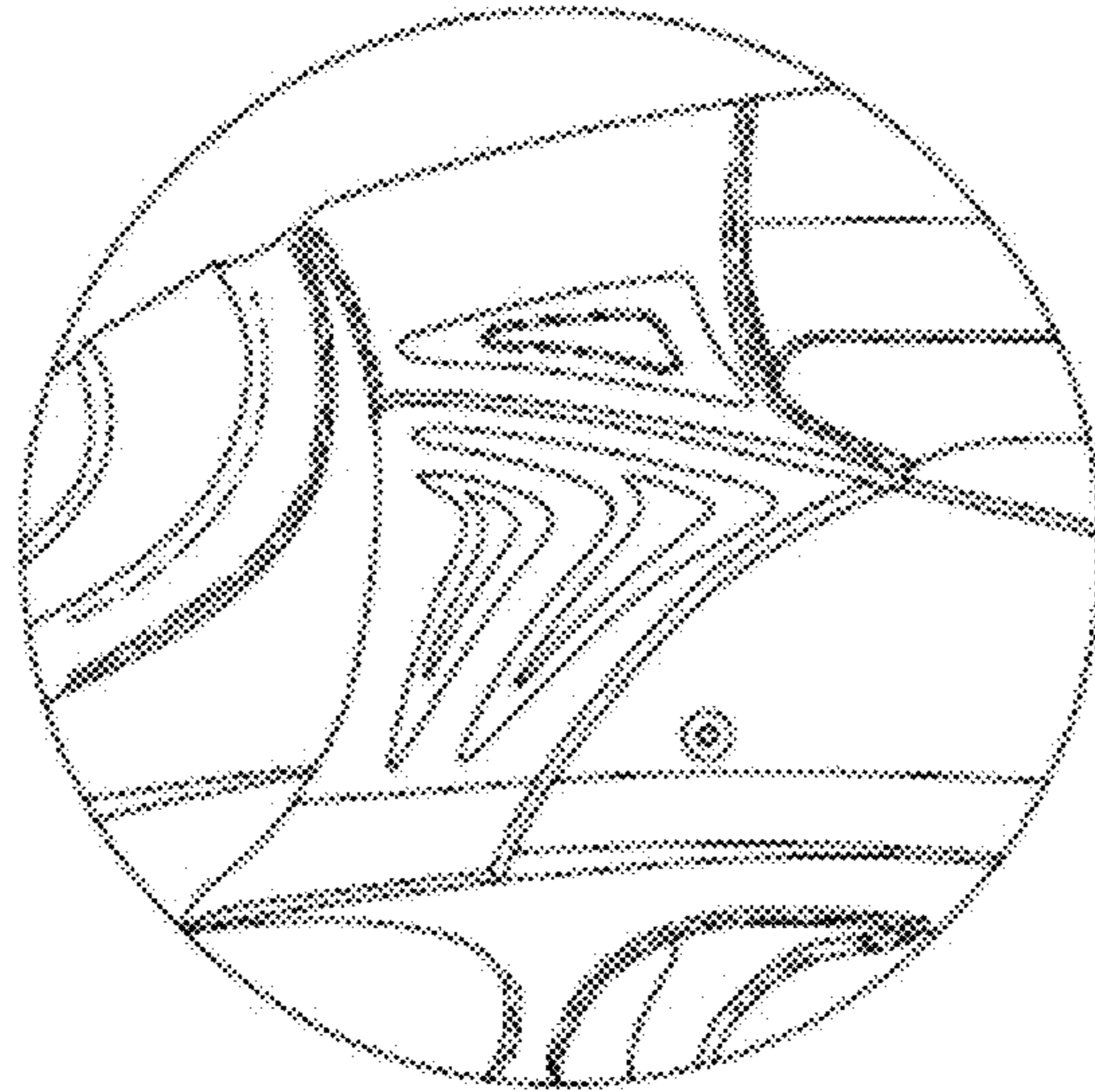

FIG. 4

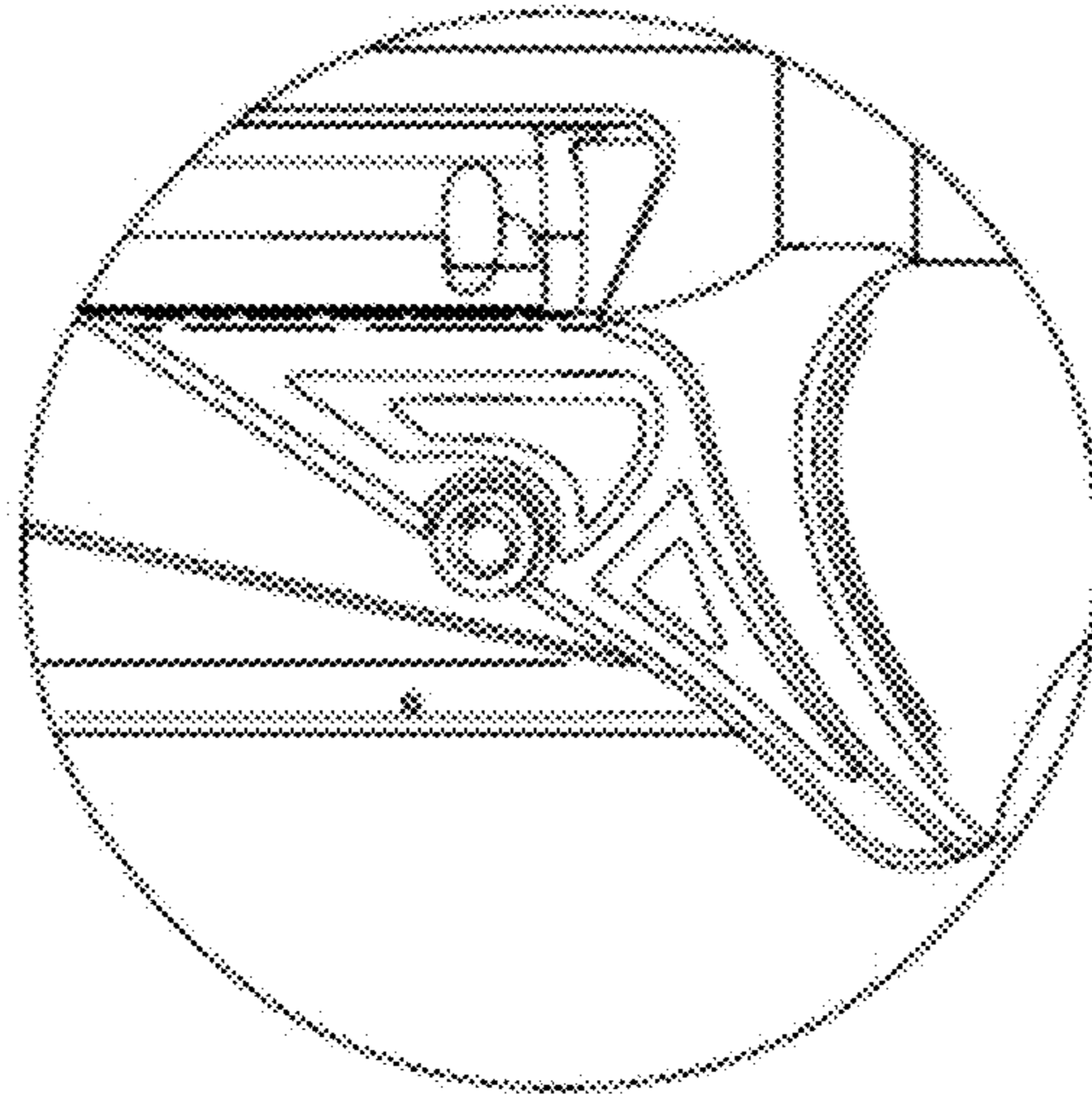

FIG. 5

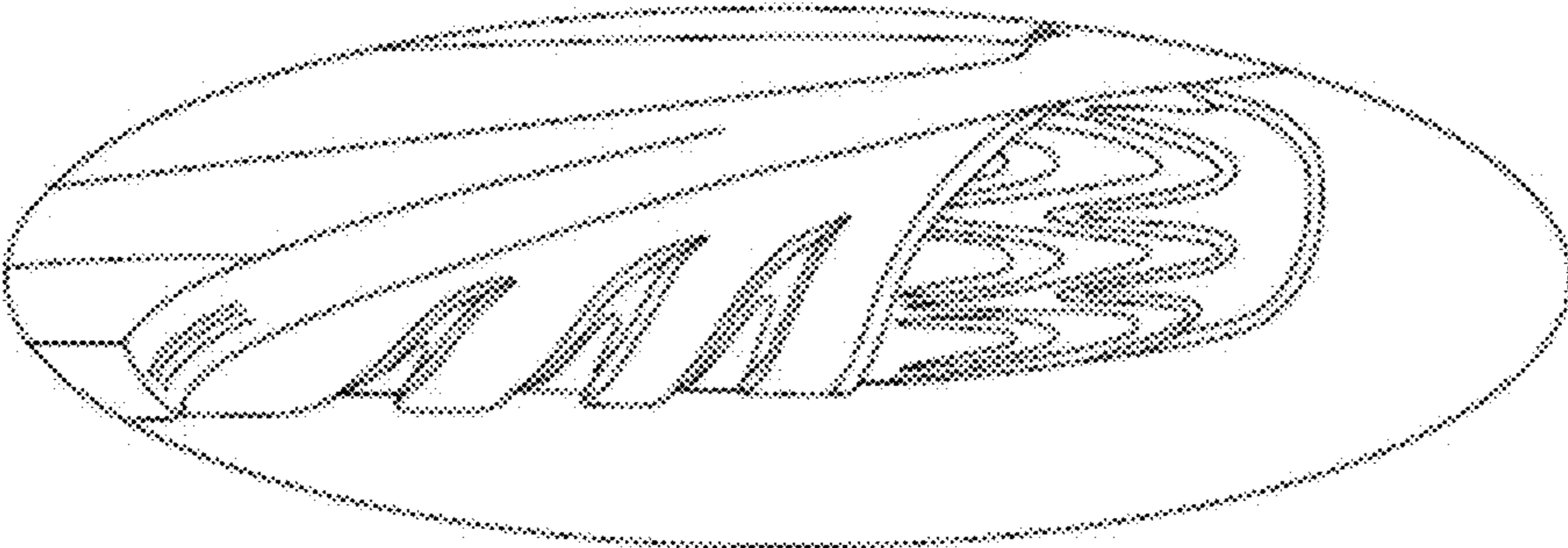

FIG. 6

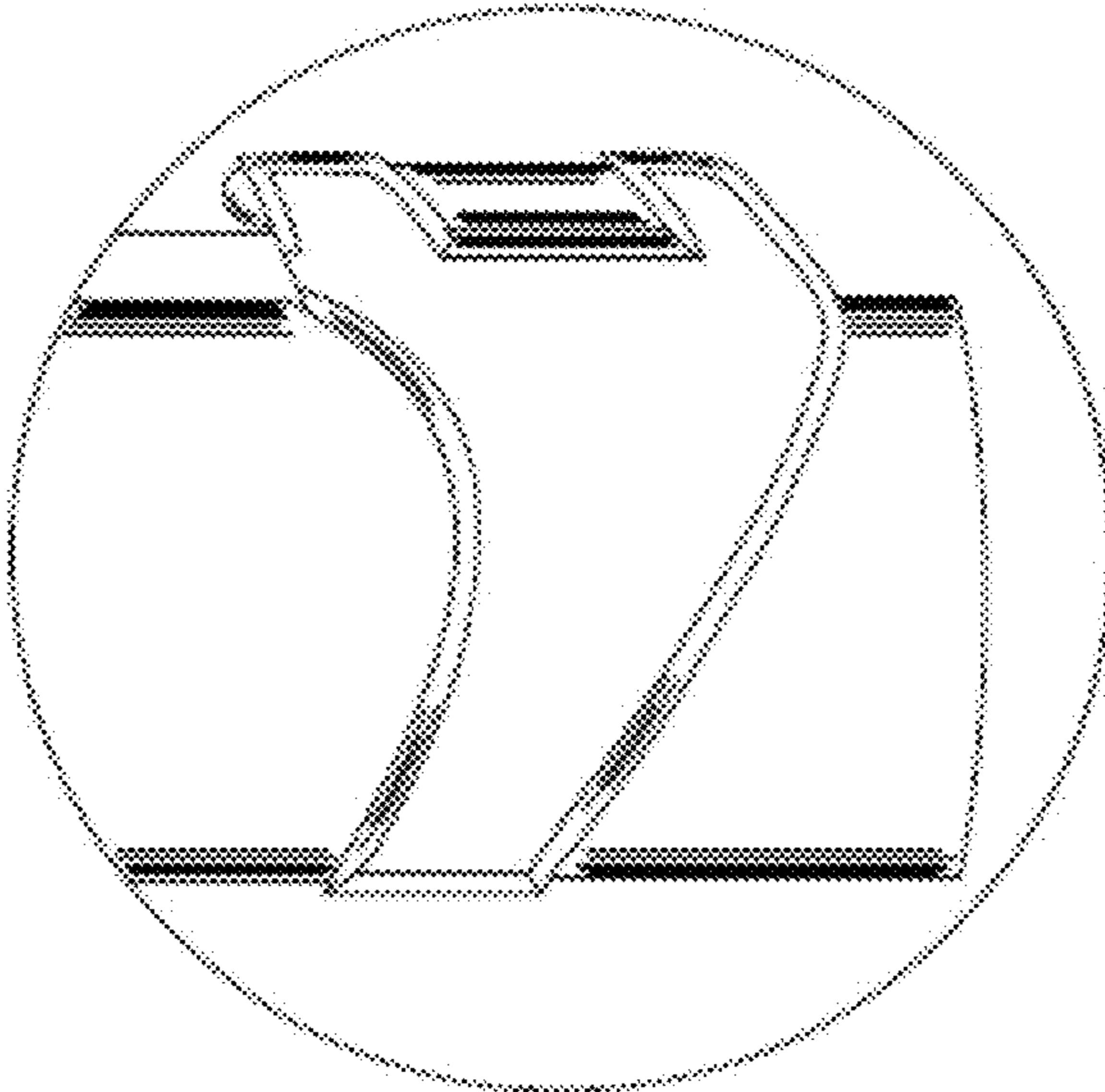

FIG. 7

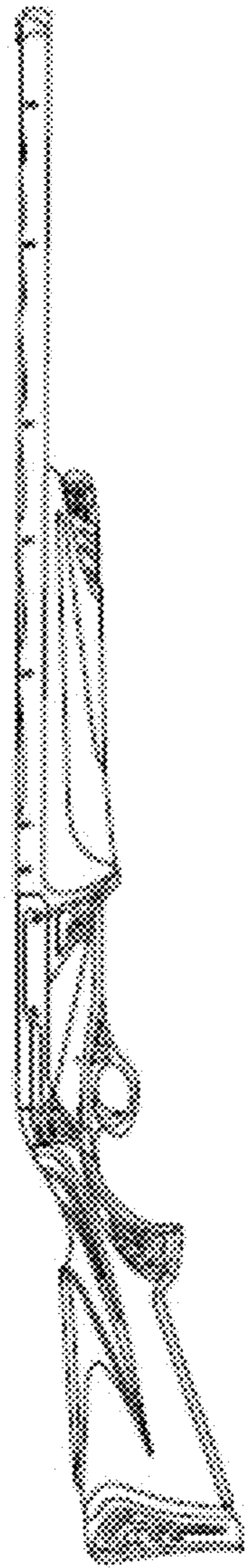

FIG. 8

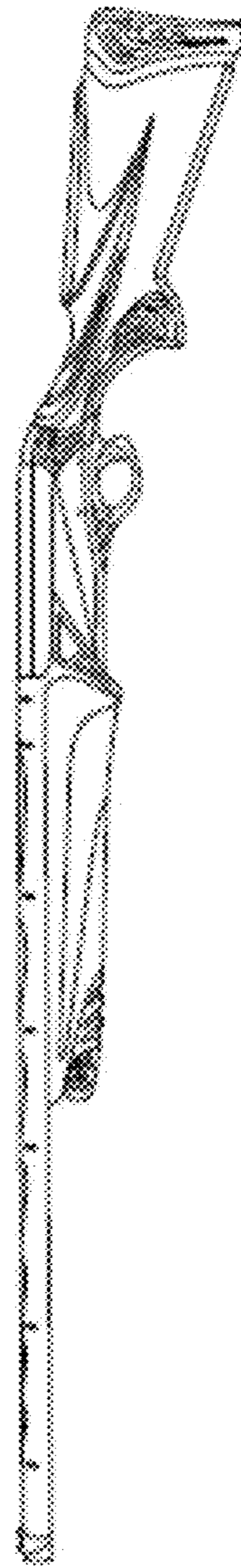

FIG. 9

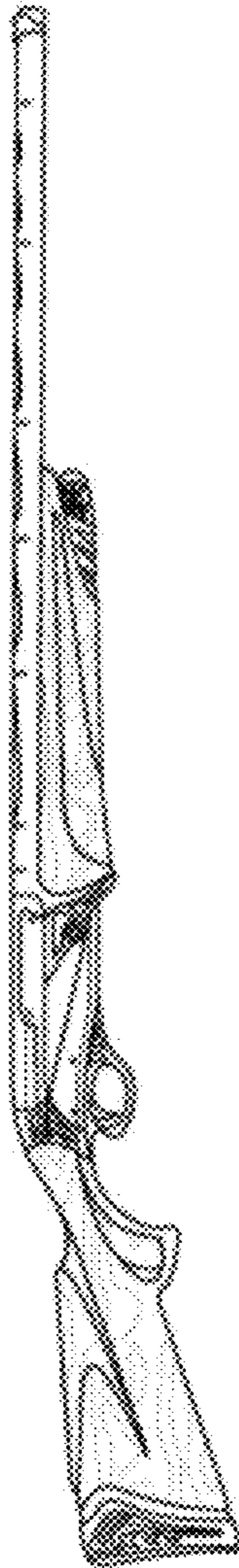

FIG. 10

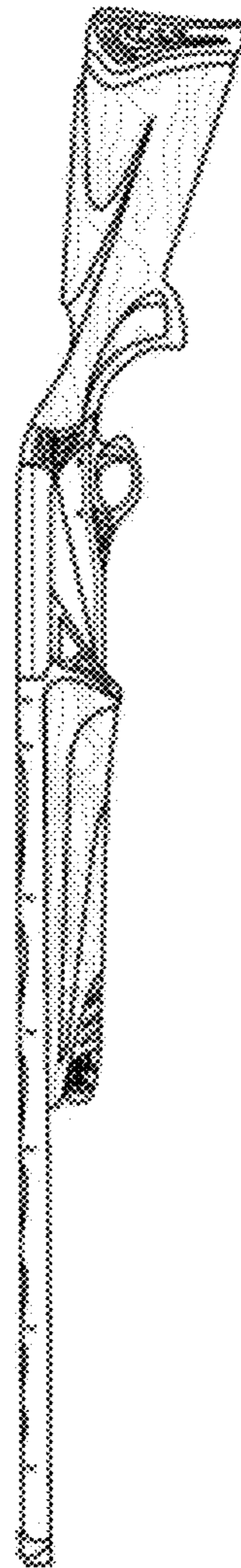

FIG. 11