



US00D723630S

(12) **United States Design Patent**
Kanbar et al.

(10) **Patent No.:** **US D723,630 S**
(45) **Date of Patent:** **** Mar. 3, 2015**

(54) **BASE BLOCK FOR A TOY CONSTRUCTION SET**

(71) Applicants: **Maurice S. Kanbar**, San Francisco, CA (US); **Albert Kolvites**, San Mateo, CA (US)

(72) Inventors: **Maurice S. Kanbar**, San Francisco, CA (US); **Albert Kolvites**, San Mateo, CA (US)

(73) Assignee: **Maurice S. Kanbar Revocable Trust**, San Francisco, CA (US)

(**) Term: **14 Years**

(21) Appl. No.: **29/488,479**

(22) Filed: **Apr. 18, 2014**

Related U.S. Application Data

(63) Continuation-in-part of application No. 14/180,211, filed on Feb. 13, 2014.

(51) **LOC (10) Cl.** **21-01**

(52) **U.S. Cl.**
USPC **D21/485**

(58) **Field of Classification Search**
CPC A63H 33/00; A63H 33/04; A63H 33/06; A63H 33/08; A63H 33/10; A63H 33/12; A63H 33/14; A63F 9/08; A63F 9/12; G09B 1/36
USPC D21/478, 479, 484, 485-505; 446/69, 446/85, 102-128; 434/208, 259, 403; 273/153, 156, 160; 428/174; D25/113-116, 118

See application file for complete search history.

(56) **References Cited**

U.S. PATENT DOCUMENTS

| | | | | |
|-----------|-----|---------|-----------------|---------|
| 3,442,044 | A * | 5/1969 | Quercetti | 446/124 |
| 3,748,752 | A * | 7/1973 | Quercetti | 434/96 |
| 3,819,188 | A * | 6/1974 | Freedman | 273/160 |
| 4,164,091 | A * | 8/1979 | Lin | 446/118 |
| D285,587 | S * | 9/1986 | Murdough et al. | D21/491 |
| D343,460 | S * | 1/1994 | Hair | D25/113 |
| D370,944 | S * | 6/1996 | Hessler | D21/491 |
| D499,151 | S * | 11/2004 | Arabian | D21/480 |
| D645,912 | S * | 9/2011 | Hardstaff | D21/502 |

* cited by examiner

Primary Examiner — Cynthia M Chin

(74) *Attorney, Agent, or Firm* — Litts Law Firm

(57) **CLAIM**

The ornamental design for a base block for a toy construction set, as shown and described.

DESCRIPTION

FIG. 1 is an upper front perspective view of a base block for a toy construction set showing our new design; FIG. 2 is a lower front perspective view thereof; FIG. 3 is a top plan view thereof; FIG. 4 is a bottom plan view thereof; FIG. 5 is a front elevation view thereof; FIG. 6 is a rear elevation view thereof; FIG. 7 is a left side elevation view thereof; and, FIG. 8 is a right side elevation view thereof.

1 Claim, 6 Drawing Sheets

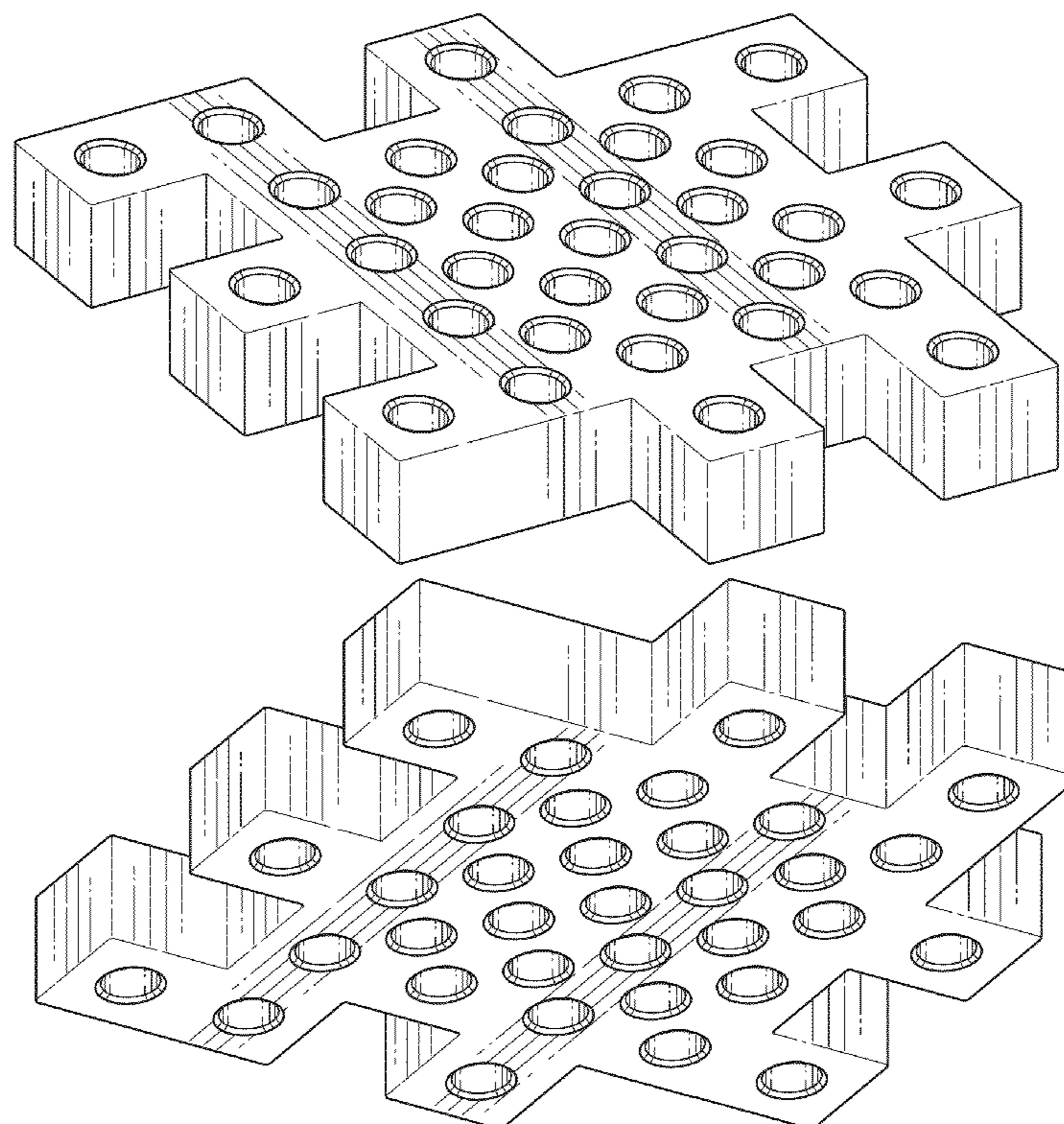

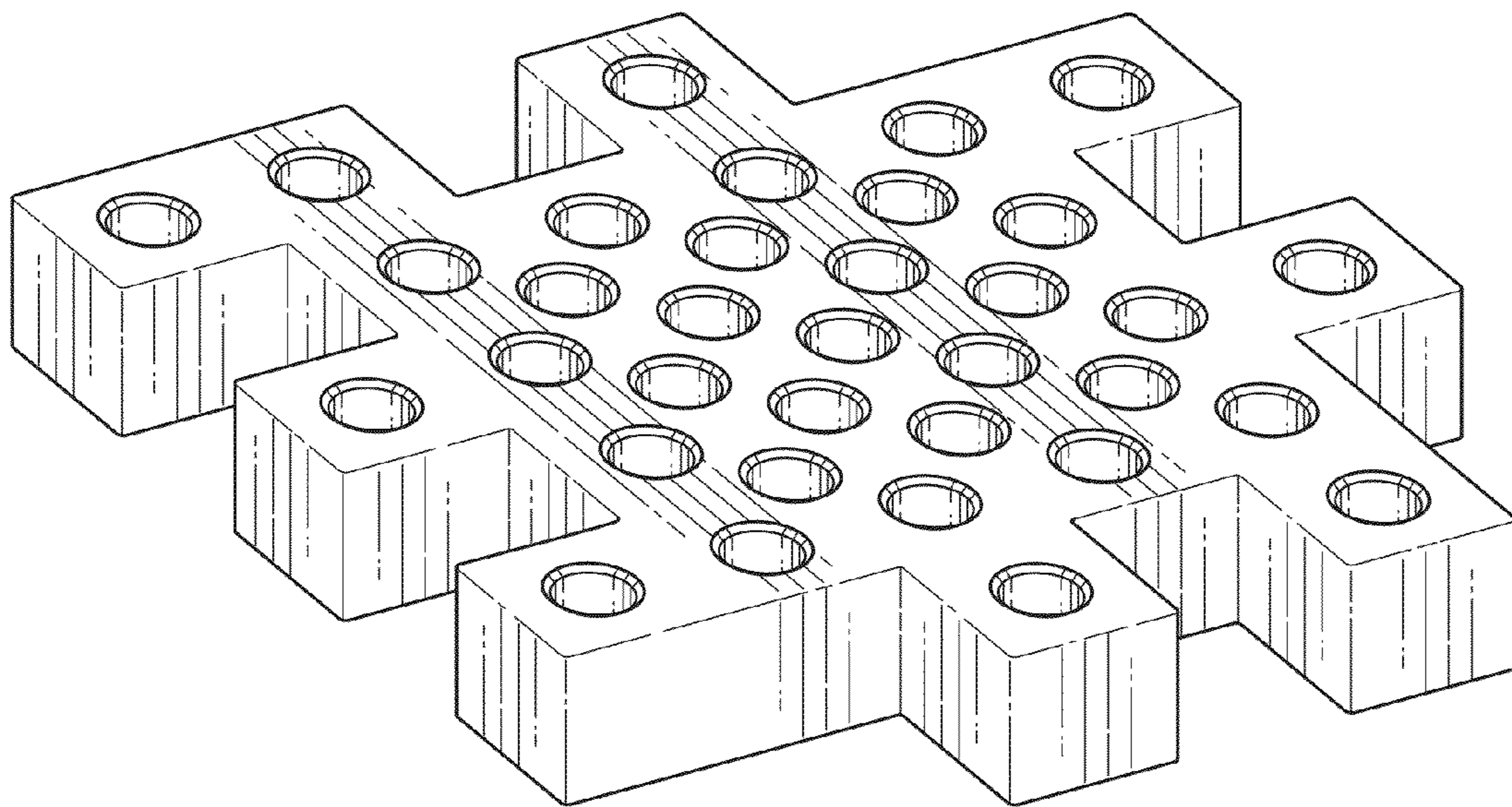

FIG. 1

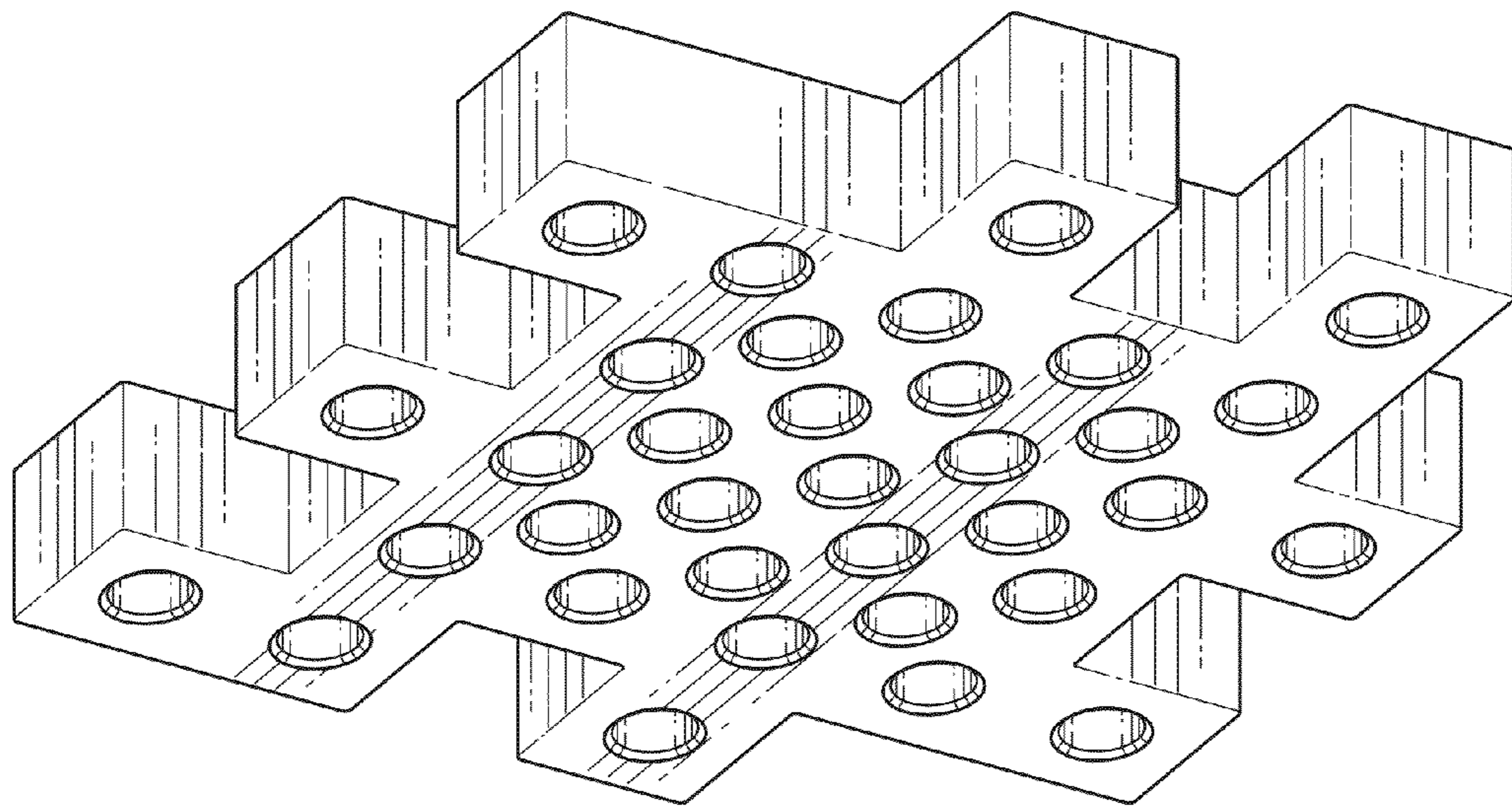

FIG. 2

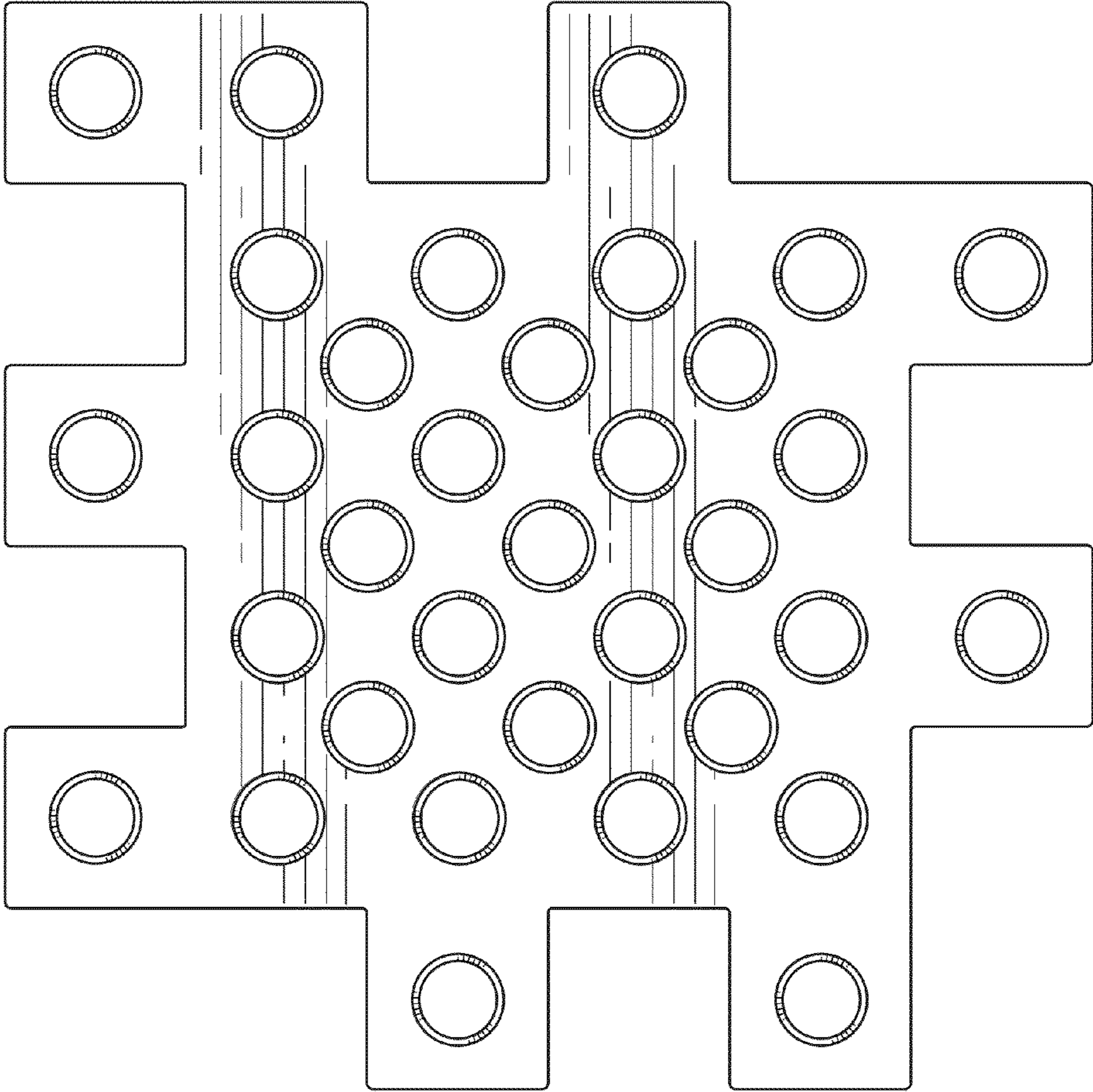

FIG. 3

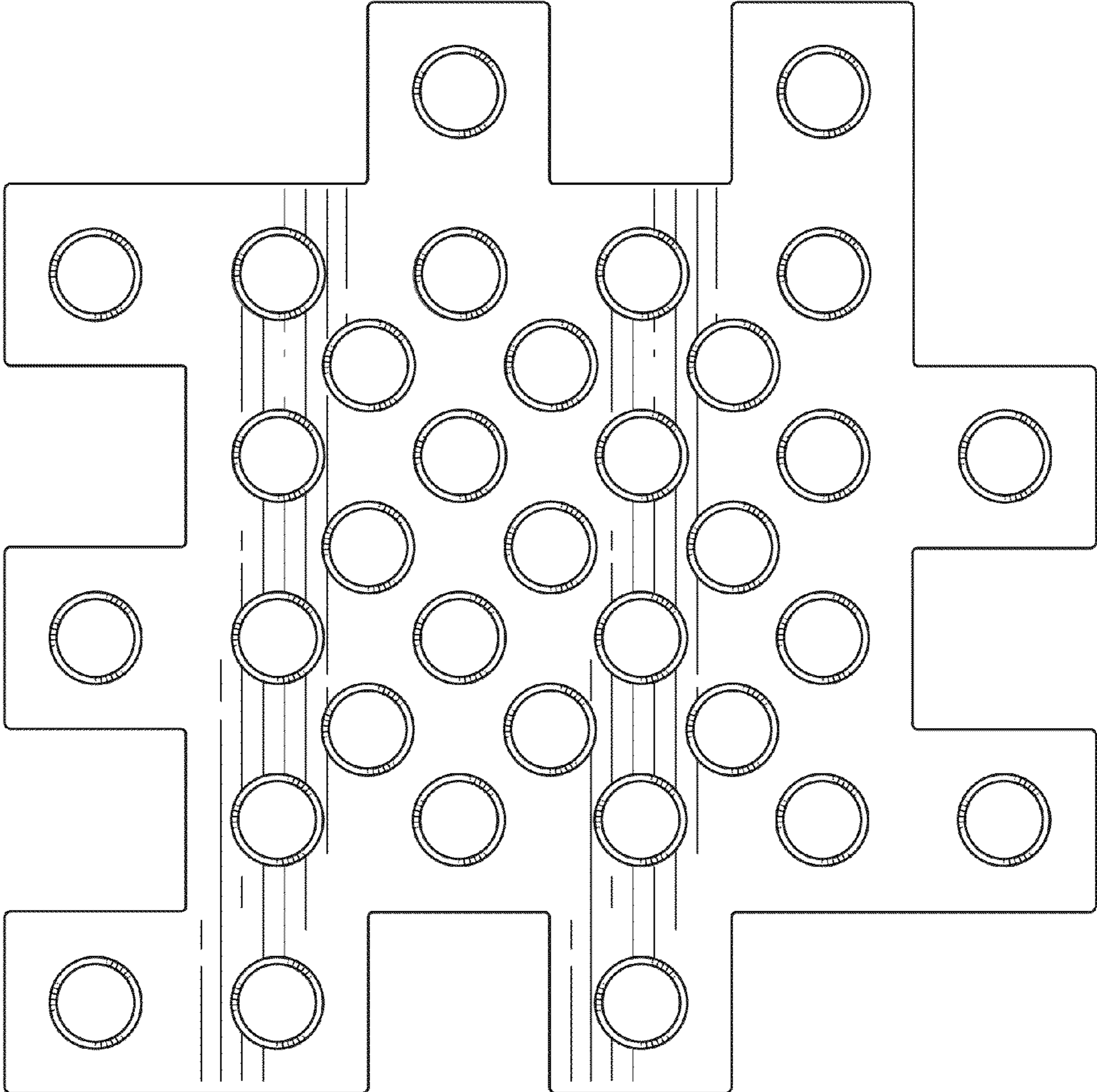

FIG. 4

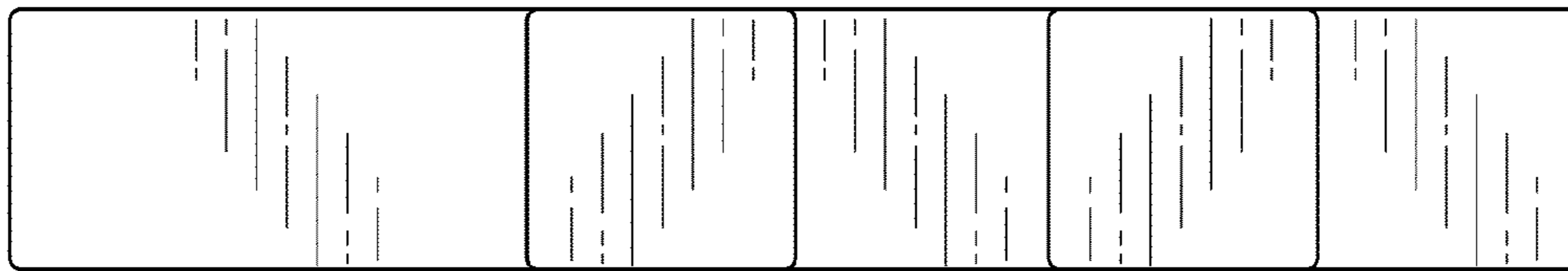

FIG. 5

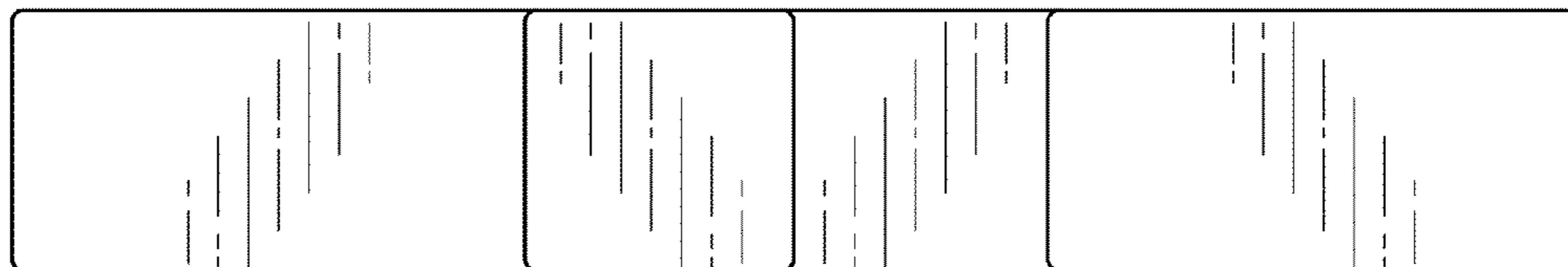

FIG. 6

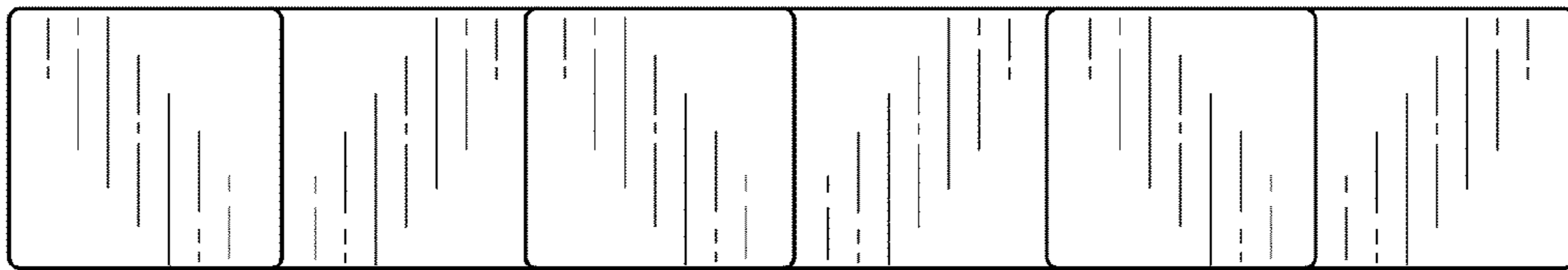

FIG. 7

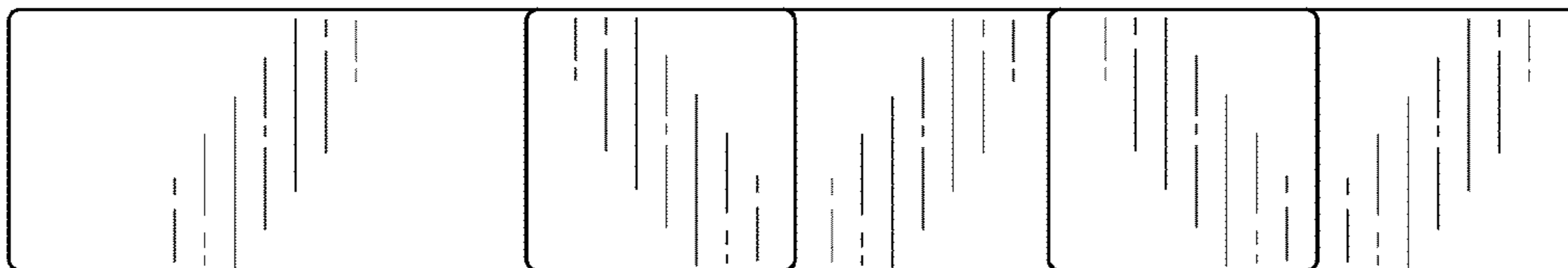

FIG. 8