



US00D723605S

(12) **United States Design Patent**
Palm

(10) **Patent No.:** **US D723,605 S**
(45) **Date of Patent:** **** Mar. 3, 2015**

(54) **CAMERA**
(71) Applicant: **FLIR System AB**, Täby (SE)
(72) Inventor: **Gunnar Palm**, Järfälla (SE)
(73) Assignee: **FLIR Systems AB**, Taby (SE)
(**) Term: **14 Years**

7,236,243 B2 6/2007 Beecroft et al.
7,250,603 B1 7/2007 Nugent
D585,927 S * 2/2009 Sheard et al. D16/206
D599,392 S * 9/2009 Hamrelius D16/206
D658,222 S 4/2012 Elrod et al.
D665,440 S 8/2012 Sigward
D666,928 S * 9/2012 Elrod D10/57
D667,040 S * 9/2012 Holmes D16/206
D674,486 S * 1/2013 Onuma D24/137
D677,298 S 3/2013 Hällgren
D710,424 S * 8/2014 Hallgren D16/206

(21) Appl. No.: **29/439,428**

* cited by examiner

(22) Filed: **Dec. 11, 2012**

Primary Examiner — Randall Gholson

(30) **Foreign Application Priority Data**

(74) *Attorney, Agent, or Firm* — Haynes and Boone LLP

Jun. 14, 2012 (EM) 002058180-0001

(57) **CLAIM**

The ornamental design for a camera, as shown and described.

(51) **LOC (10) Cl.** **16-01**

DESCRIPTION

(52) **U.S. Cl.**
USPC **D16/206**

(58) **Field of Classification Search**
USPC D16/200, 202, 203, 206, 208, 218, 243;
250/330; 348/373, 376; 396/419
See application file for complete search history.

FIG. 1 is a bottom-left-rear perspective view of a camera embodying our new design;
FIG. 2 is a top-left-front perspective view thereof;
FIG. 3 is a front elevational view thereof;
FIG. 4 is a rear elevational view thereof;
FIG. 5 is a right side elevational view thereof;
FIG. 6 is a left side elevational view thereof;
FIG. 7 is a top plan view thereof; and,
FIG. 8 is a bottom plan view thereof.

(56) **References Cited**

U.S. PATENT DOCUMENTS

D445,817 S 7/2001 Okuley
6,486,473 B2 * 11/2002 Salapow et al. 250/330
D472,911 S 4/2003 Bielefeld
D493,733 S 8/2004 Chen
D540,838 S 4/2007 Aronsson et al.

The broken lines in the figures are shown for the purpose of illustrating environmental matter and form no part of the claimed design.

1 Claim, 7 Drawing Sheets

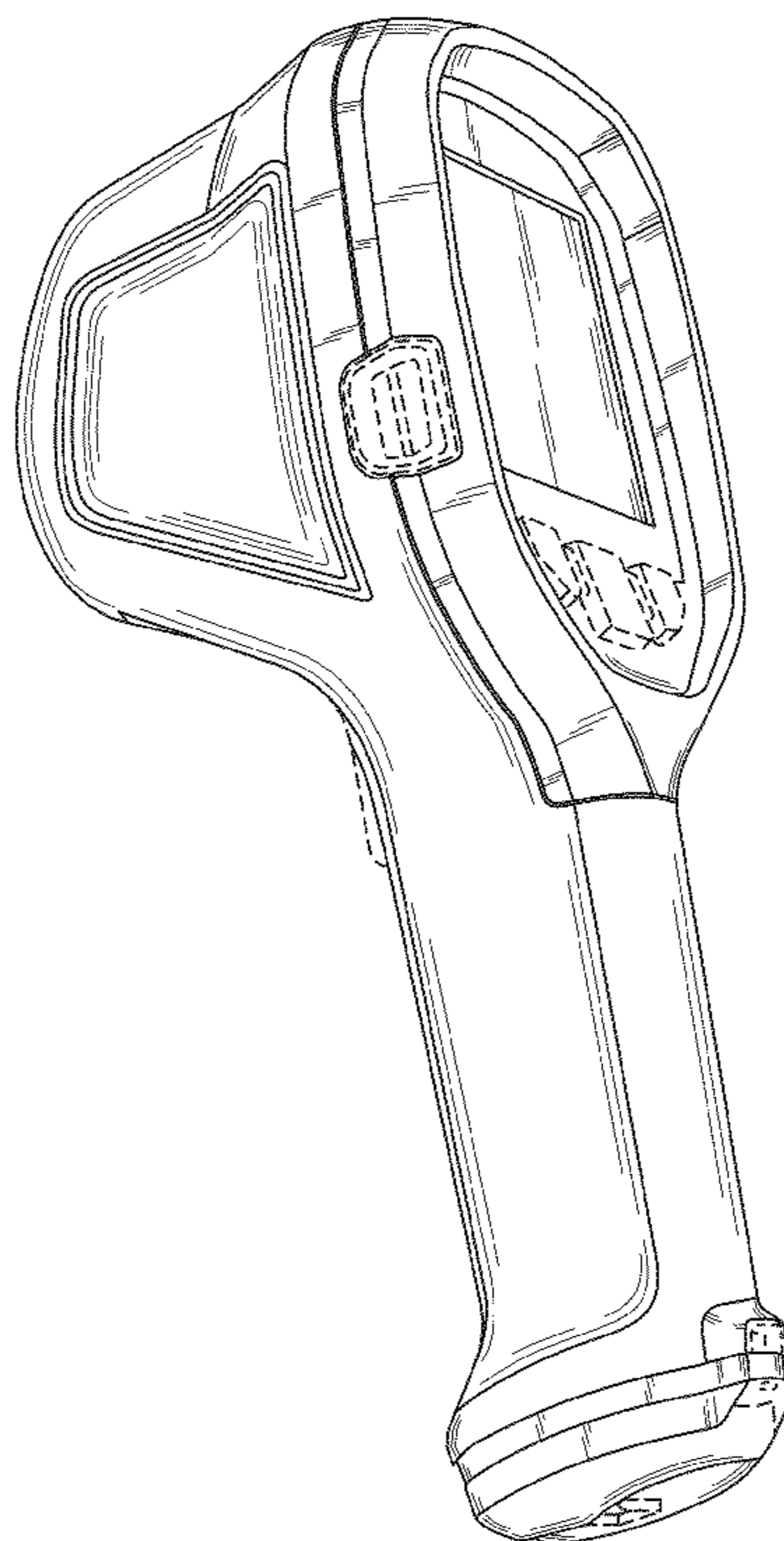

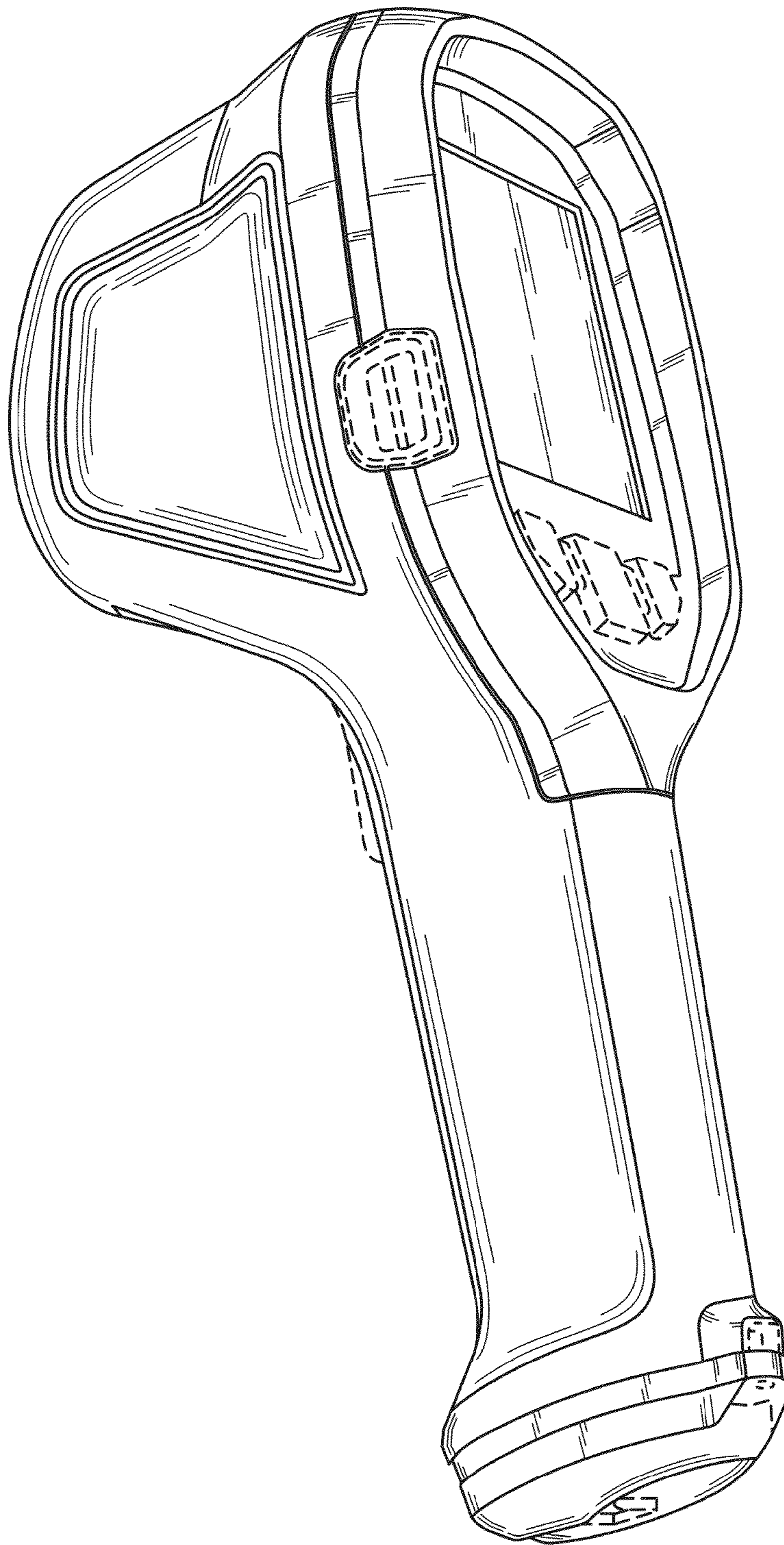

FIG. 1

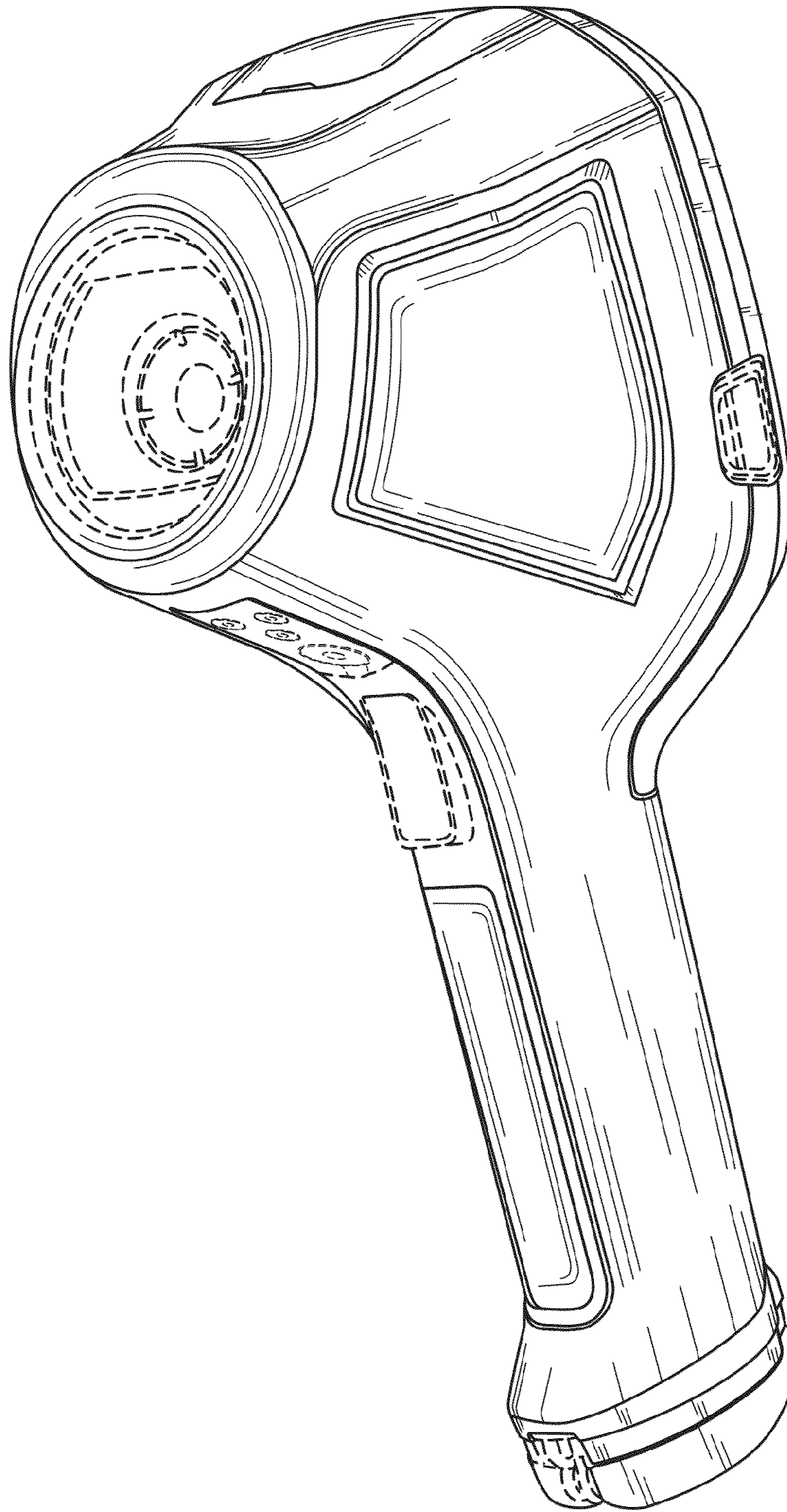

FIG. 2

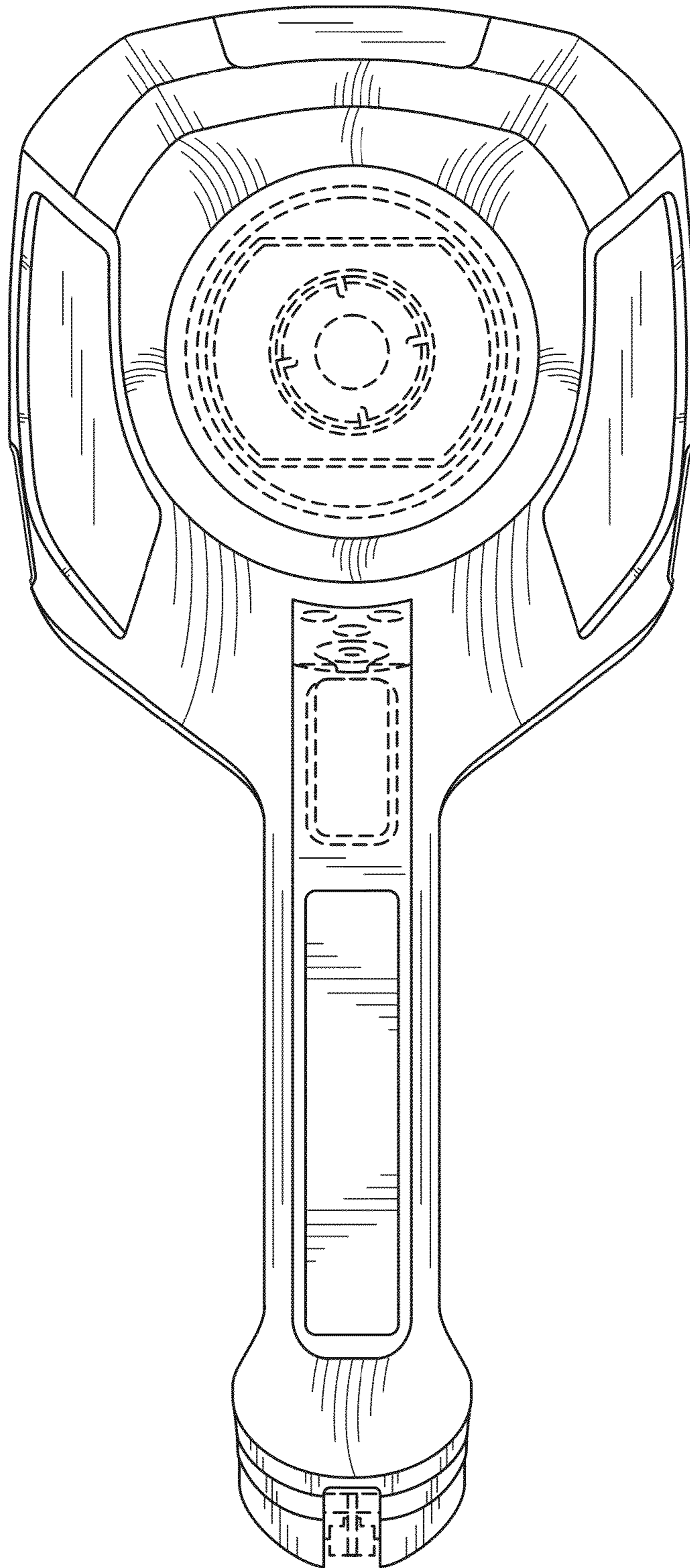

FIG. 3

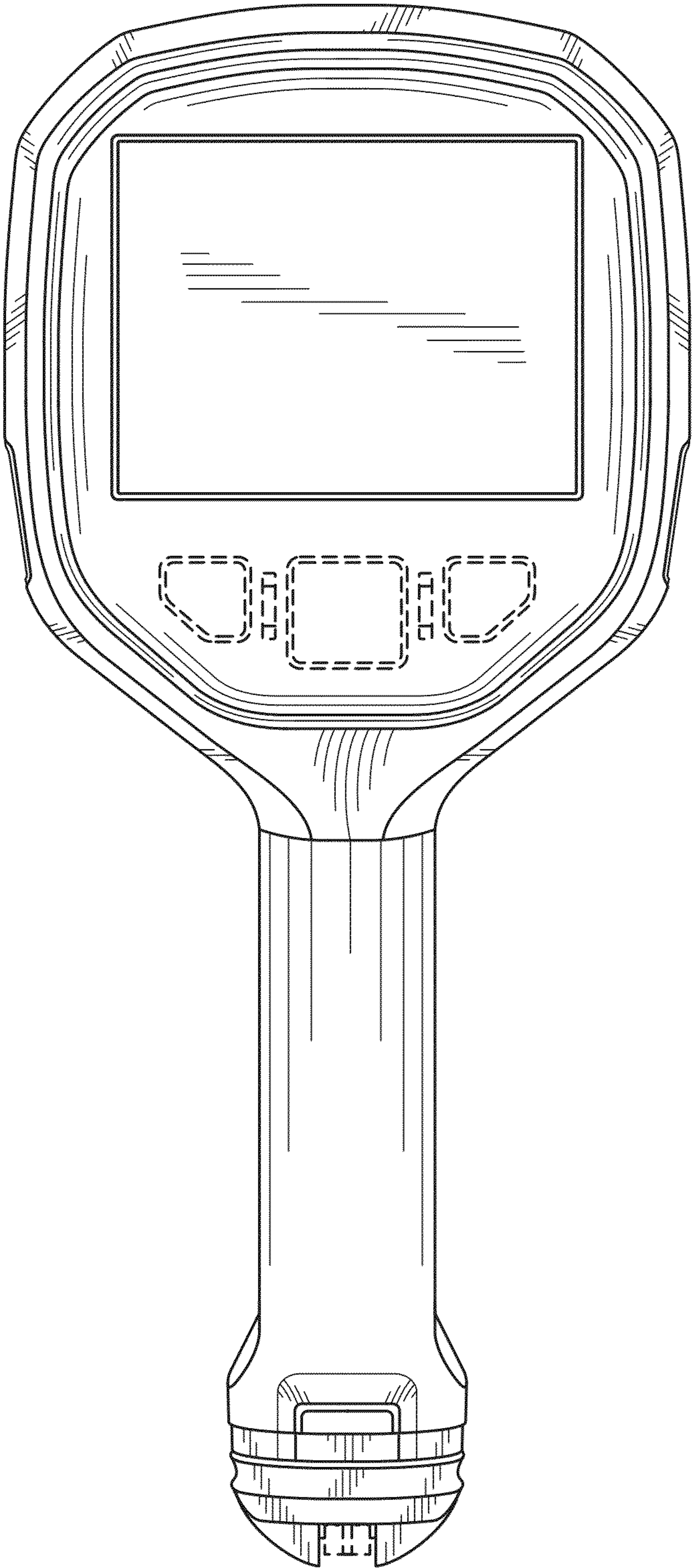

FIG. 4

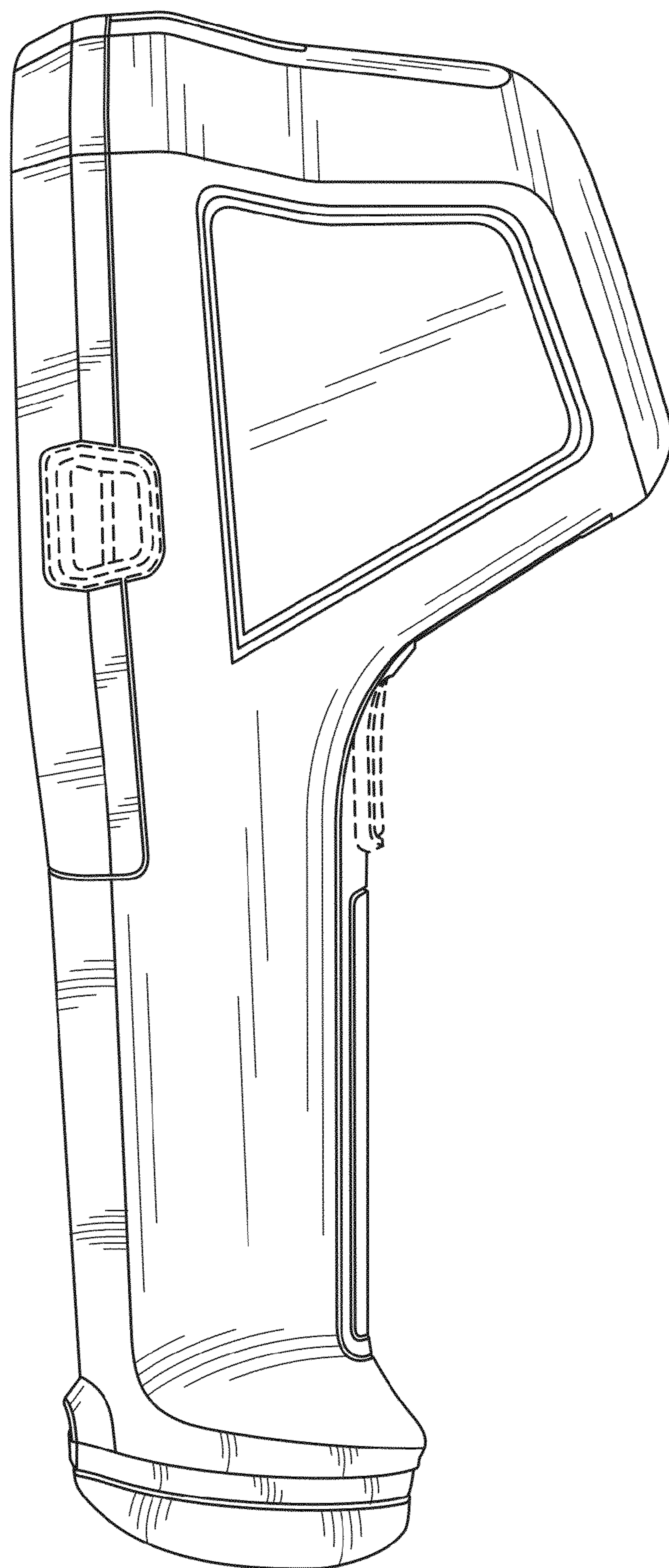

FIG. 5

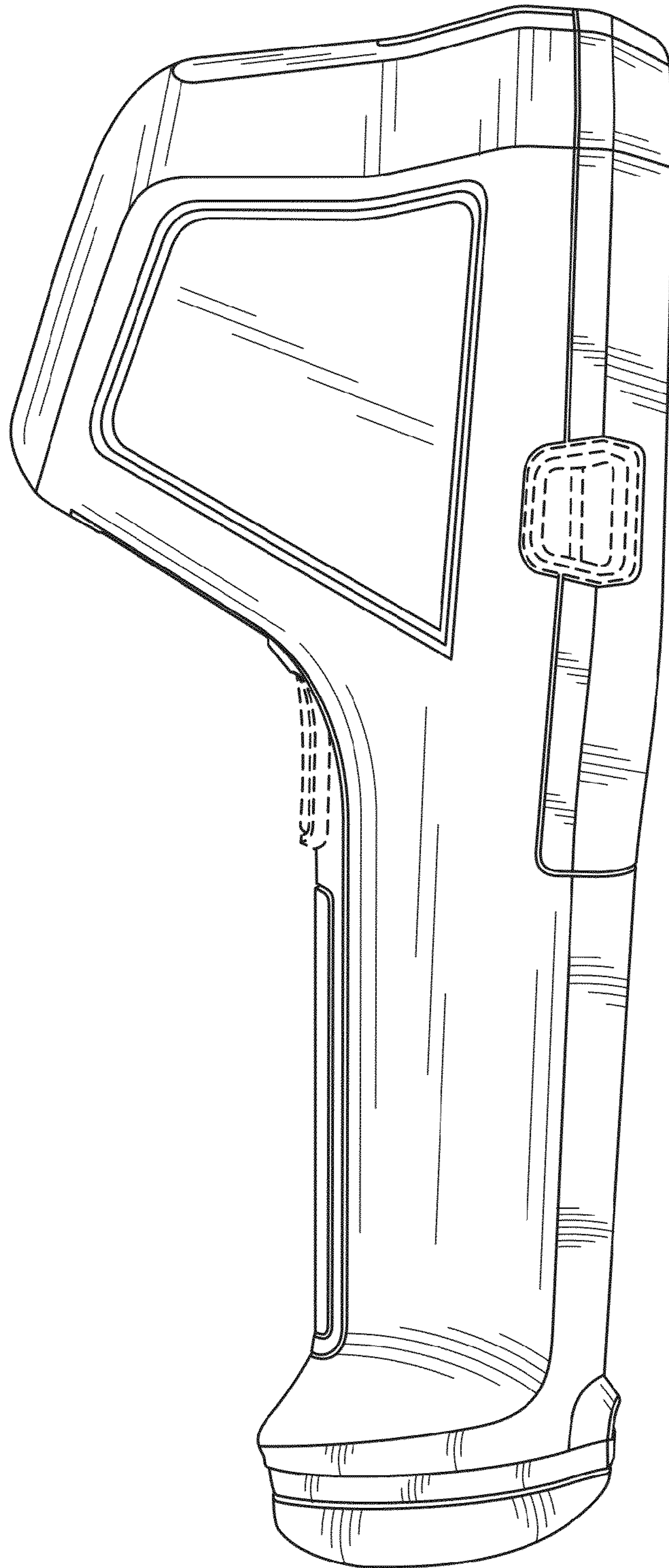

FIG. 6

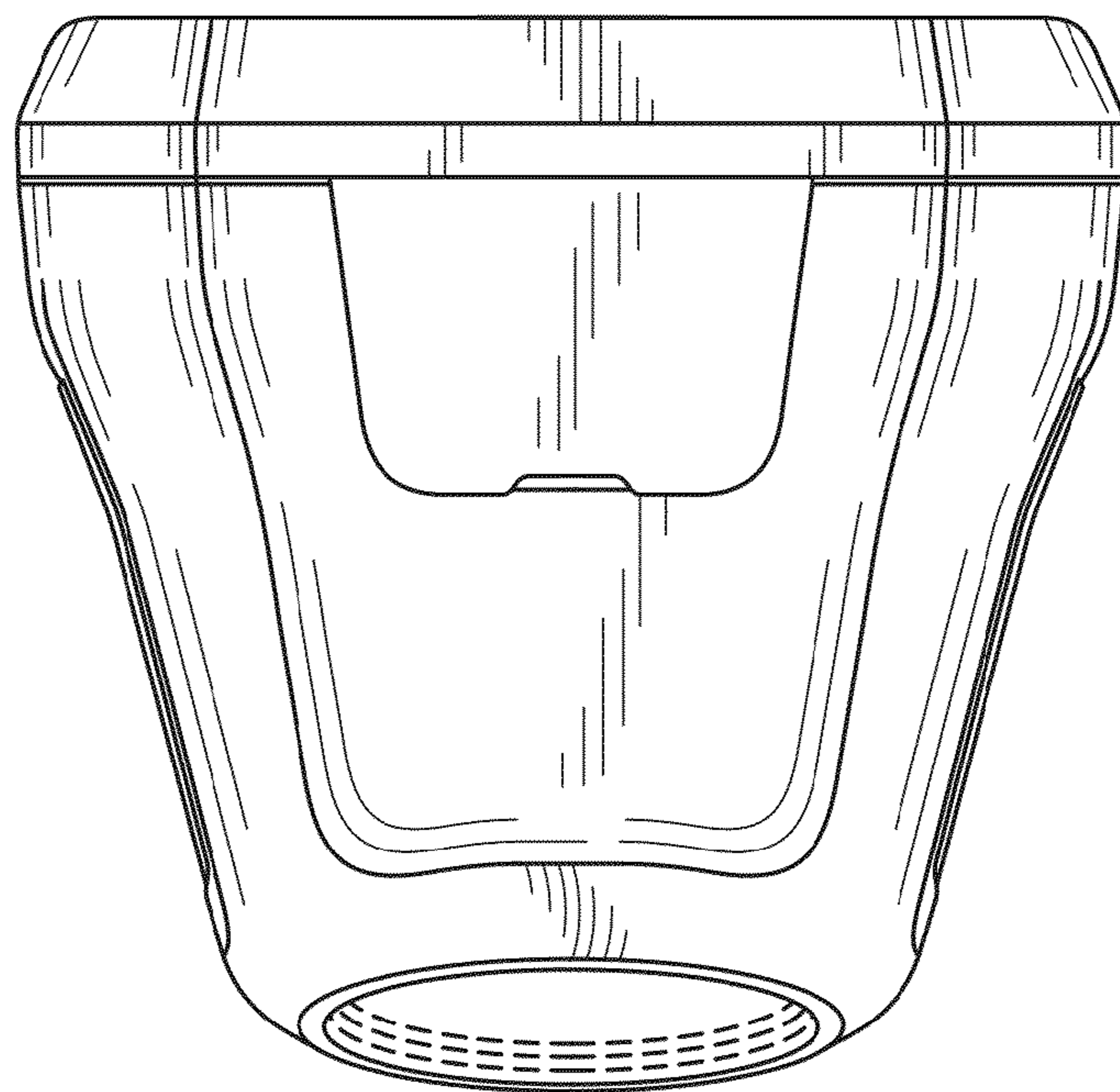

FIG. 7

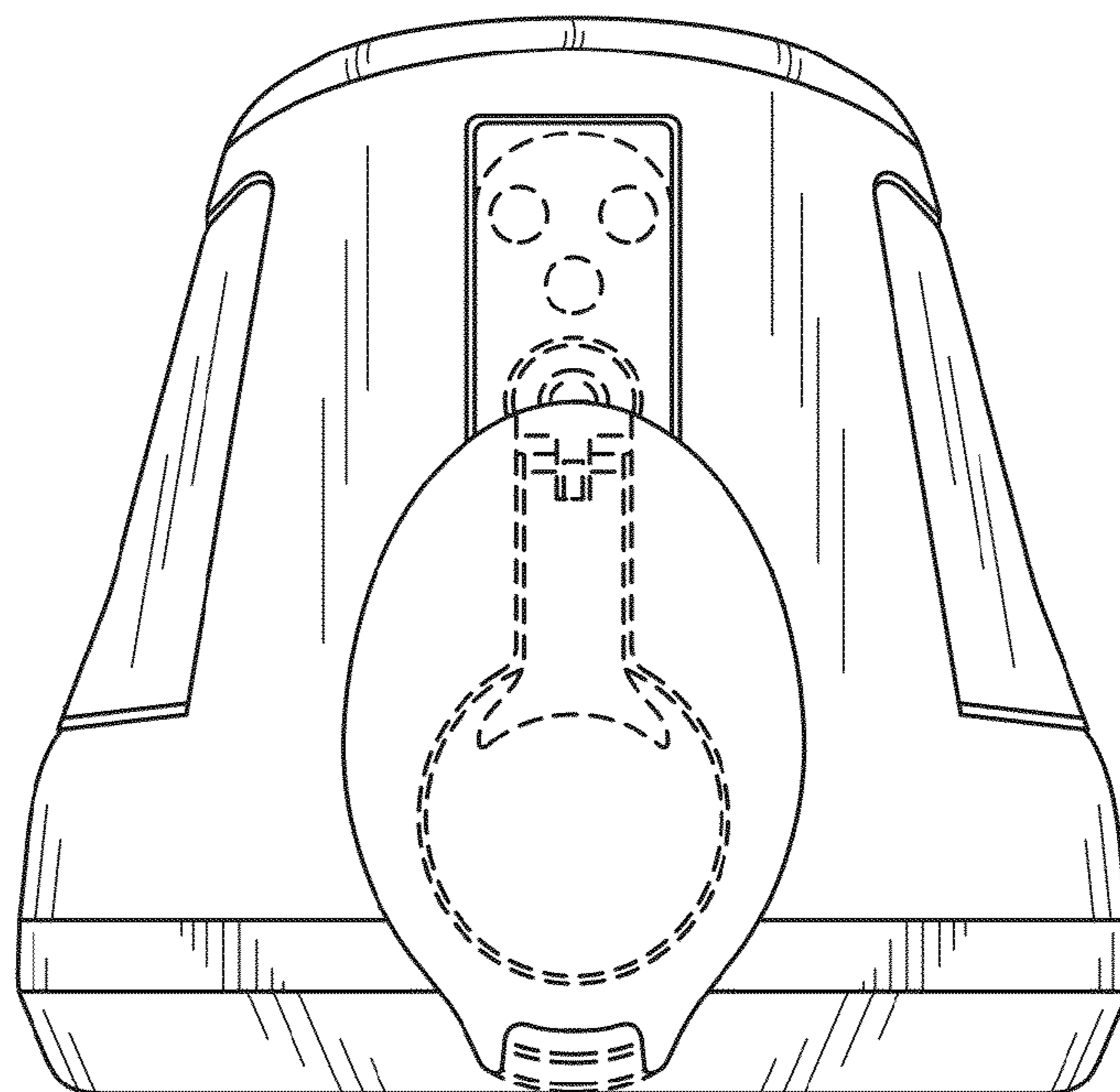

FIG. 8