



US00D723486S

(12) **United States Design Patent**
Lee et al.

(10) **Patent No.:** **US D723,486 S**
(45) **Date of Patent:** **** Mar. 3, 2015**

- (54) **TELEVISION RECEIVER**
- (71) Applicant: **LG Electronics Inc.**, Seoul (KR)
- (72) Inventors: **Yongho Lee**, Seoul (KR); **Hyojin Won**, Seoul (KR)
- (73) Assignee: **LG Electronics Inc.**, Seoul (KR)
- (**) Term: **14 Years**
- (21) Appl. No.: **29/460,563**
- (22) Filed: **Jul. 12, 2013**
- (30) **Foreign Application Priority Data**

Jan. 16, 2013 (KR) 30-2013-0002741

- (51) **LOC (10) Cl.** **14-03**
- (52) **U.S. Cl.**
USPC **D14/126**
- (58) **Field of Classification Search**
CPC ... G06F 1/1601; G06F 1/1643; H05K 5/0004;
H05K 5/0017; H05K 5/02; H05K 5/0217
USPC D14/125-134, 239, 371, 136, 374-377,
D14/440, 450, 448, 336, 342, 159; 312/7.2;
348/836, 838, 180, 184, 325, 739;
248/917-924, 465; 345/104, 133, 156,
345/168, 87, 173; D21/329, 515, 577, 622,
D21/333, 433, 448, 452, 450, 331, 505;
D10/15, 26; 446/484, 175, 356;
D6/477, 479, 300; D24/185; D34/14
See application file for complete search history.

(56) **References Cited**
U.S. PATENT DOCUMENTS

- D377,012 S * 12/1996 Oslund D14/128
- D427,597 S * 7/2000 Arfin et al. D14/375
- D455,131 S * 4/2002 Reynaga et al. D14/126
- D489,342 S * 5/2004 Campbell et al. D14/130

- D525,953 S * 8/2006 Anzures D14/126
- D586,307 S * 2/2009 Chu D14/134
- D587,226 S * 2/2009 Funayama D14/126
- D587,663 S * 3/2009 Cometti D14/126
- D626,353 S * 11/2010 Magruder D6/396
- D665,760 S * 8/2012 Chiu D14/126
- D670,257 S * 11/2012 Yang et al. D14/126
- D671,083 S * 11/2012 Kim et al. D14/126

(Continued)

Primary Examiner — Raphael Barkai
(74) *Attorney, Agent, or Firm* — Morgan, Lewis & Bockius LLP

(57) **CLAIM**
The ornamental design for a television receiver, as shown and described.

DESCRIPTION

FIG. 1 is a perspective view of a television receiver showing our new design;
 FIG. 2 is a front view thereof;
 FIG. 3 is a rear view thereof;
 FIG. 4 is a left side view thereof where the right side view is a mirror image;
 FIG. 5 is a top plan view thereof;
 FIG. 6 is a bottom plan view thereof;
 FIG. 7 is a rear perspective view thereof;
 FIG. 8 is a perspective view thereof when the stand part is separated;
 FIG. 9 is a front view thereof of FIG. 8;
 FIG. 10 is a rear view thereof of FIG. 8;
 FIG. 11 is a left side view thereof where the right side view is a mirror image of FIG. 8;
 FIG. 12 is a top plan view thereof of FIG. 8;
 FIG. 13 is a bottom plan view thereof of FIG. 8; and,
 FIG. 14 is a rear perspective view thereof of FIG. 8.
 The broken lines are for illustrative purposes only and form no part of the claimed design.

1 Claim, 14 Drawing Sheets

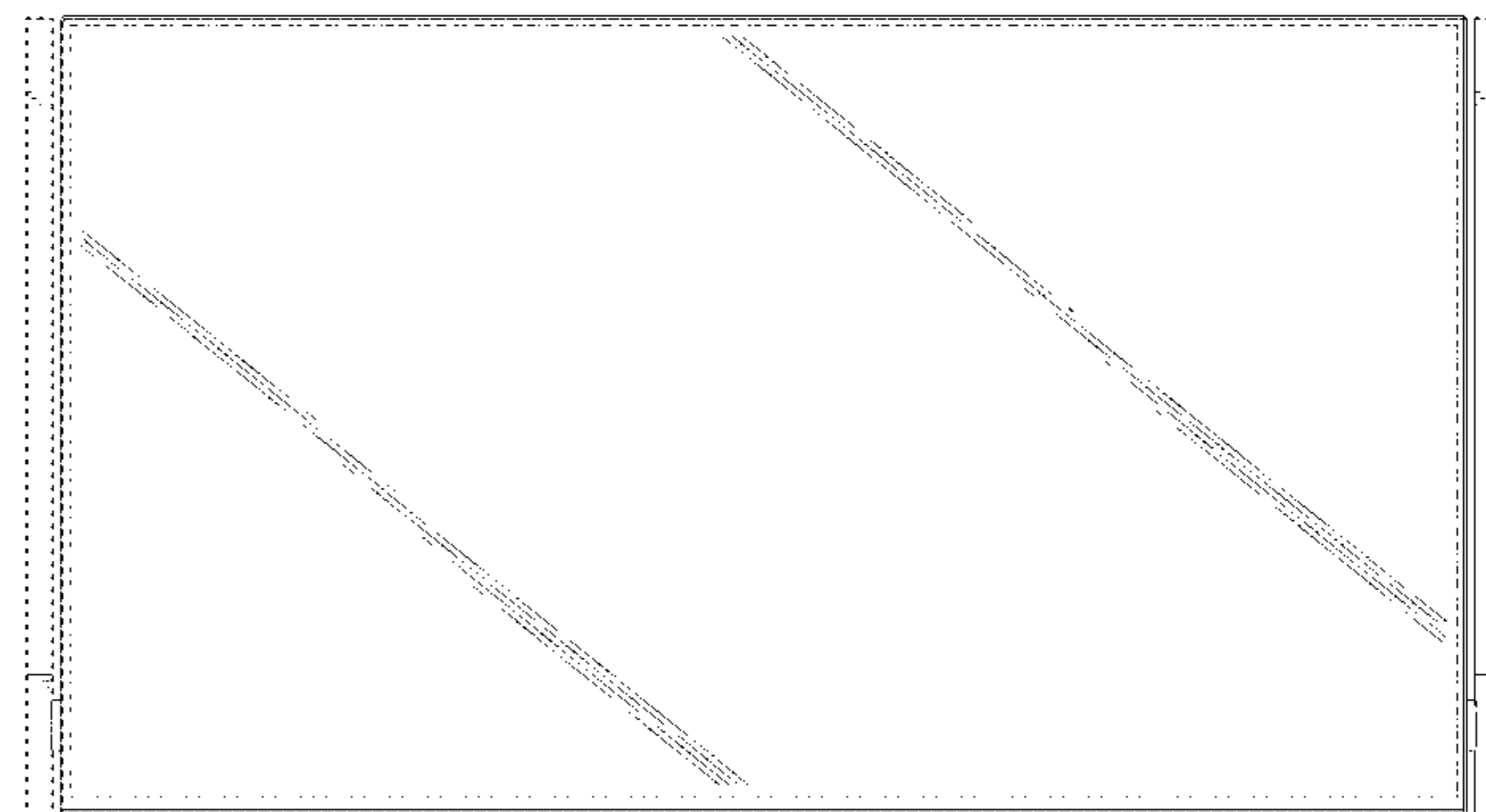
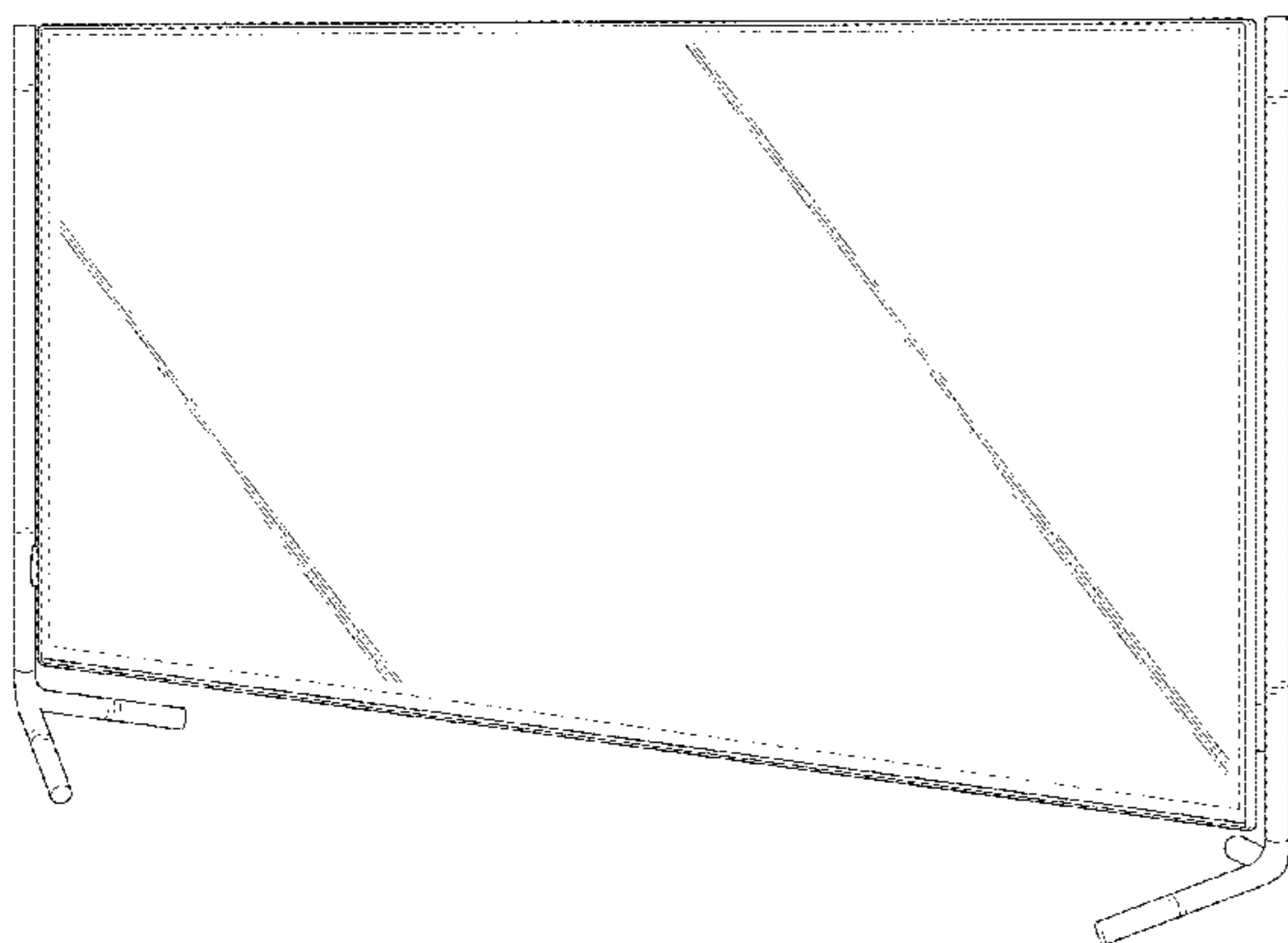

US D723,486 S

Page 2

(56)

References Cited

U.S. PATENT DOCUMENTS

D708,596 S *	7/2014	Park	D14/126	
D711,333 S *	8/2014	Kim	D14/126	* cited by examiner
D713,808 S *	9/2014	Ryu et al.	D14/126	
D714,238 S *	9/2014	Kim	D14/126	
D716,244 S *	10/2014	Kim et al.	D14/126	

FIG. 1

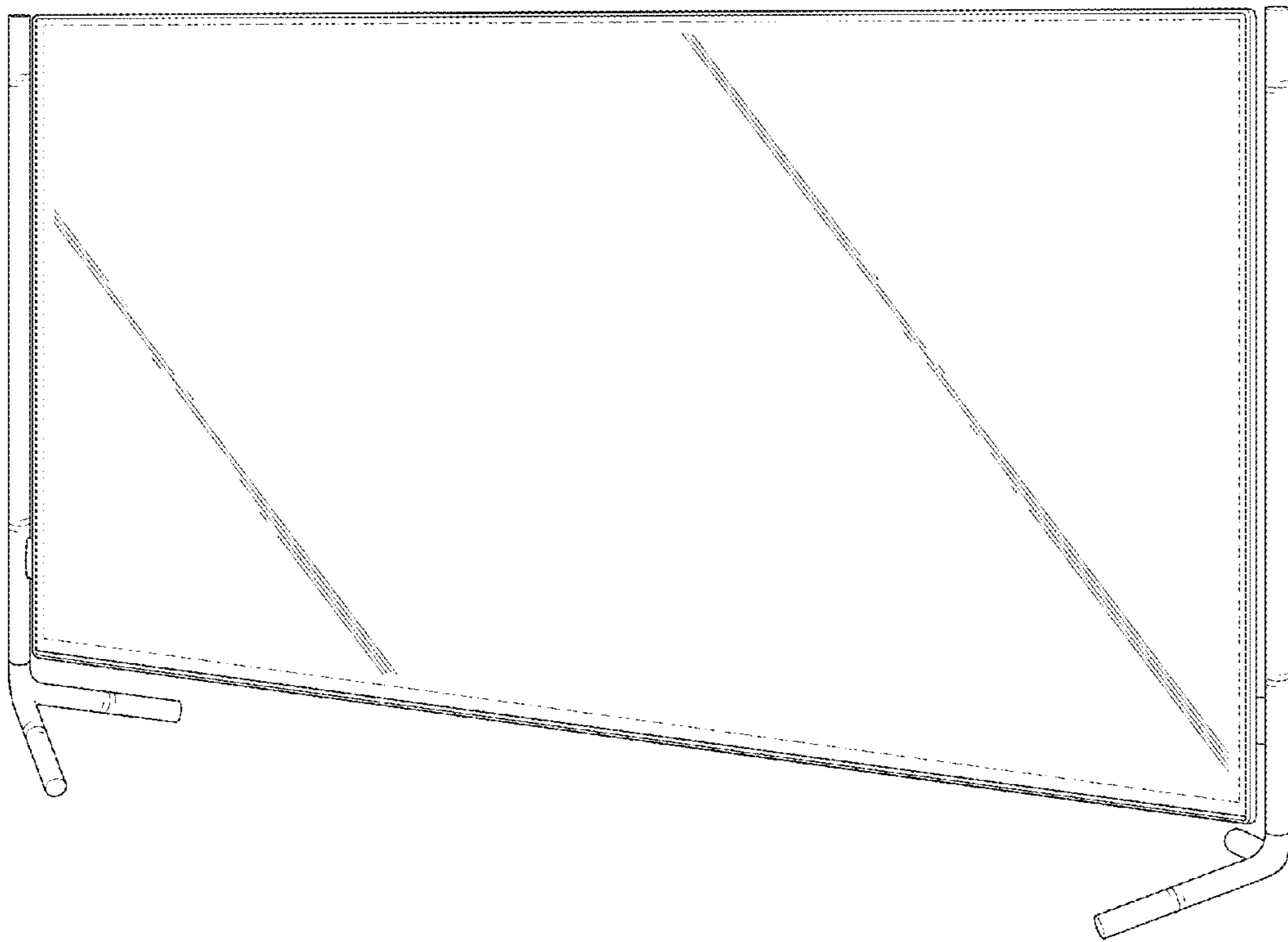

FIG. 2

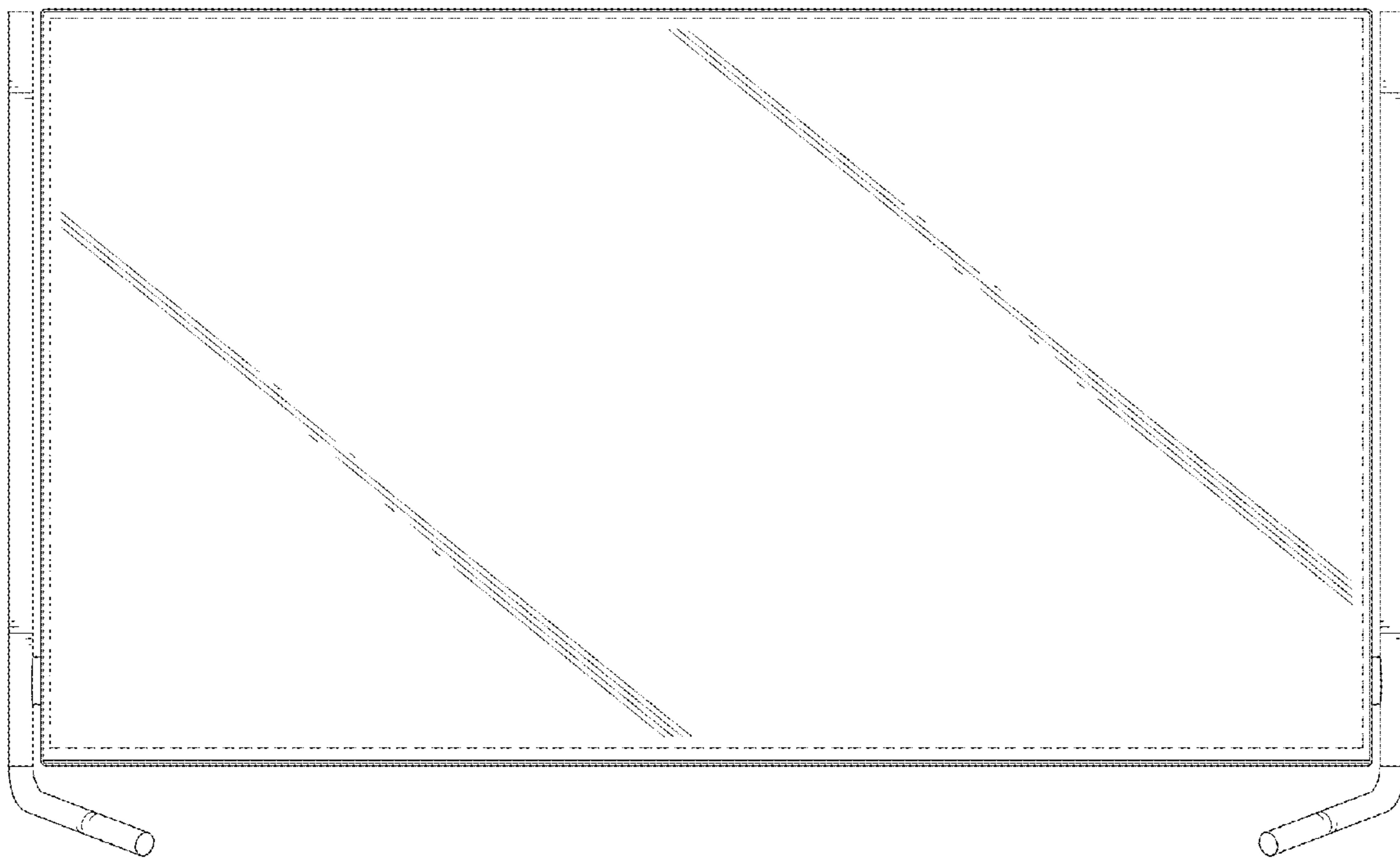

FIG. 3

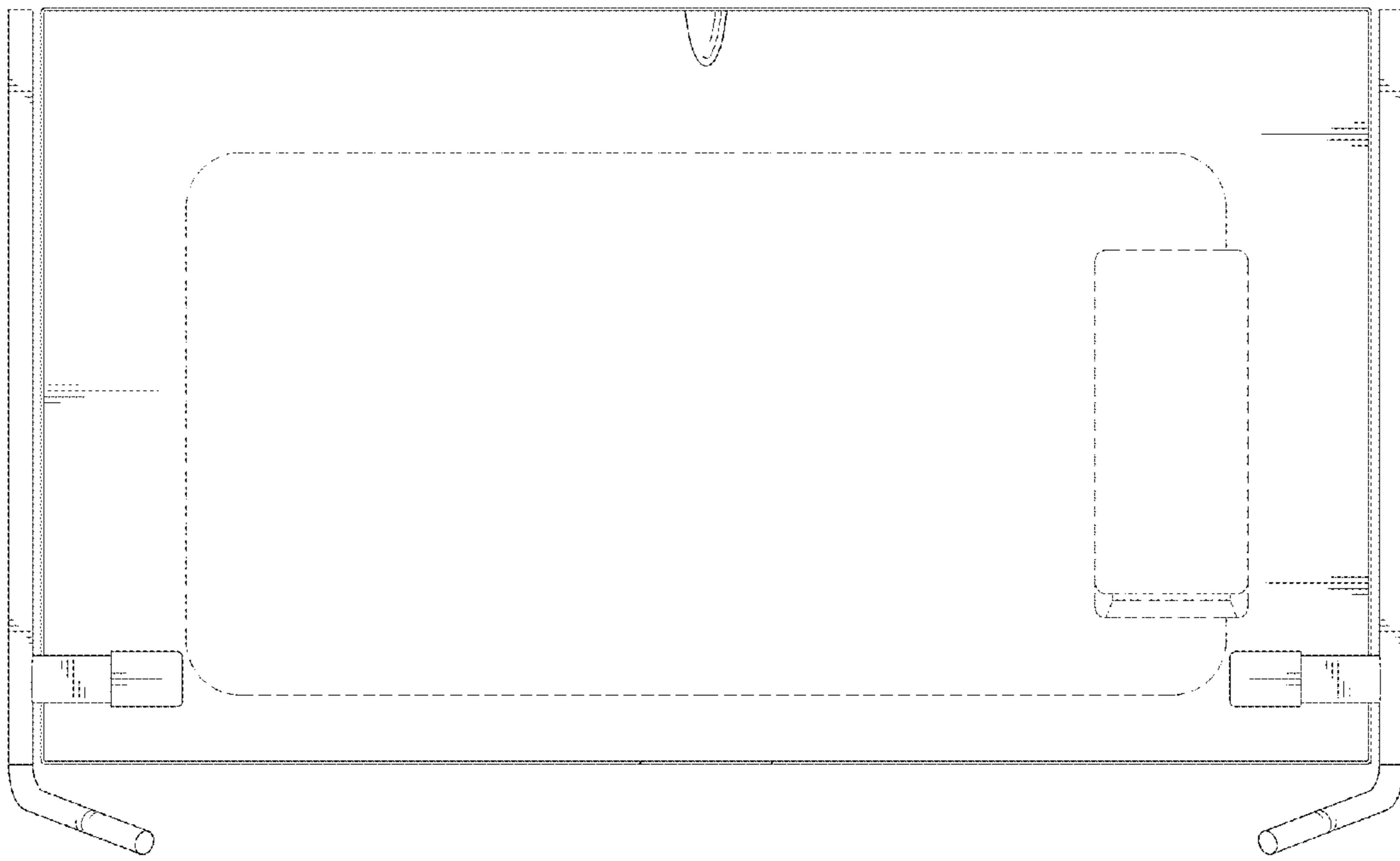

FIG. 4

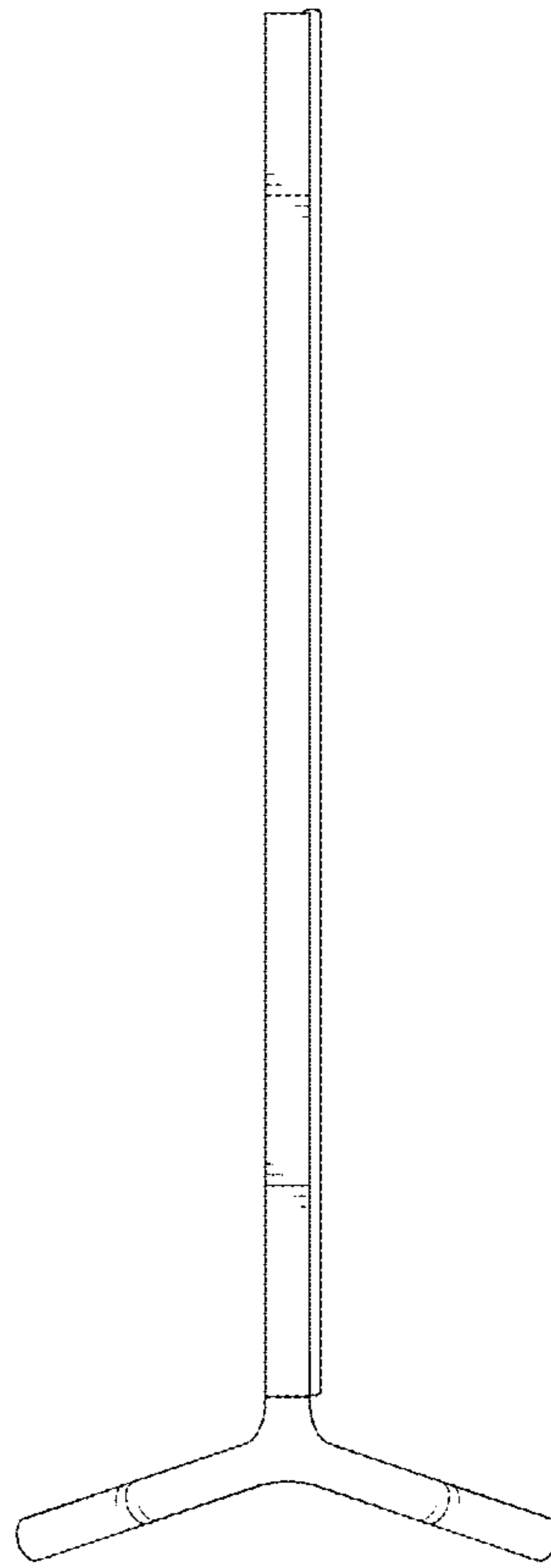

FIG. 5

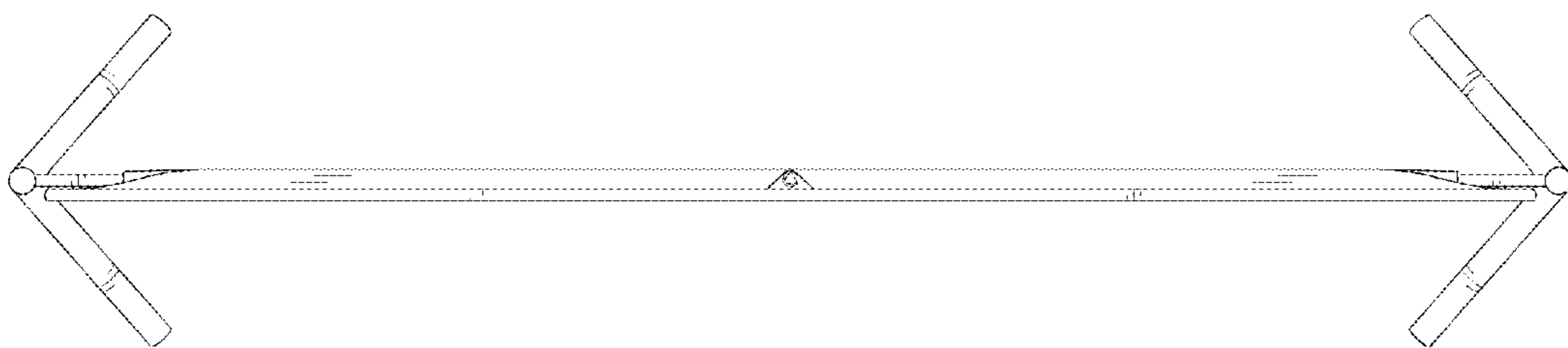

FIG. 6

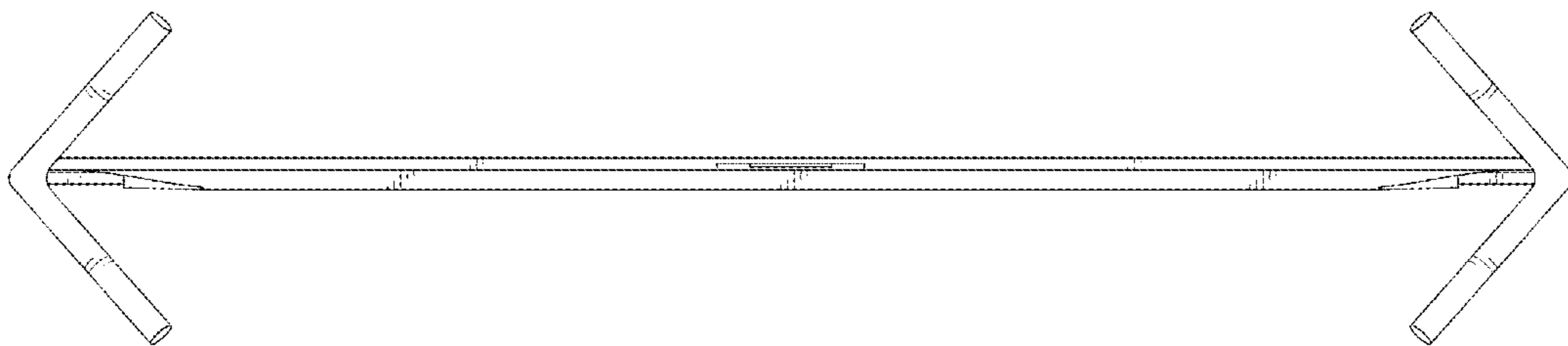

FIG. 7

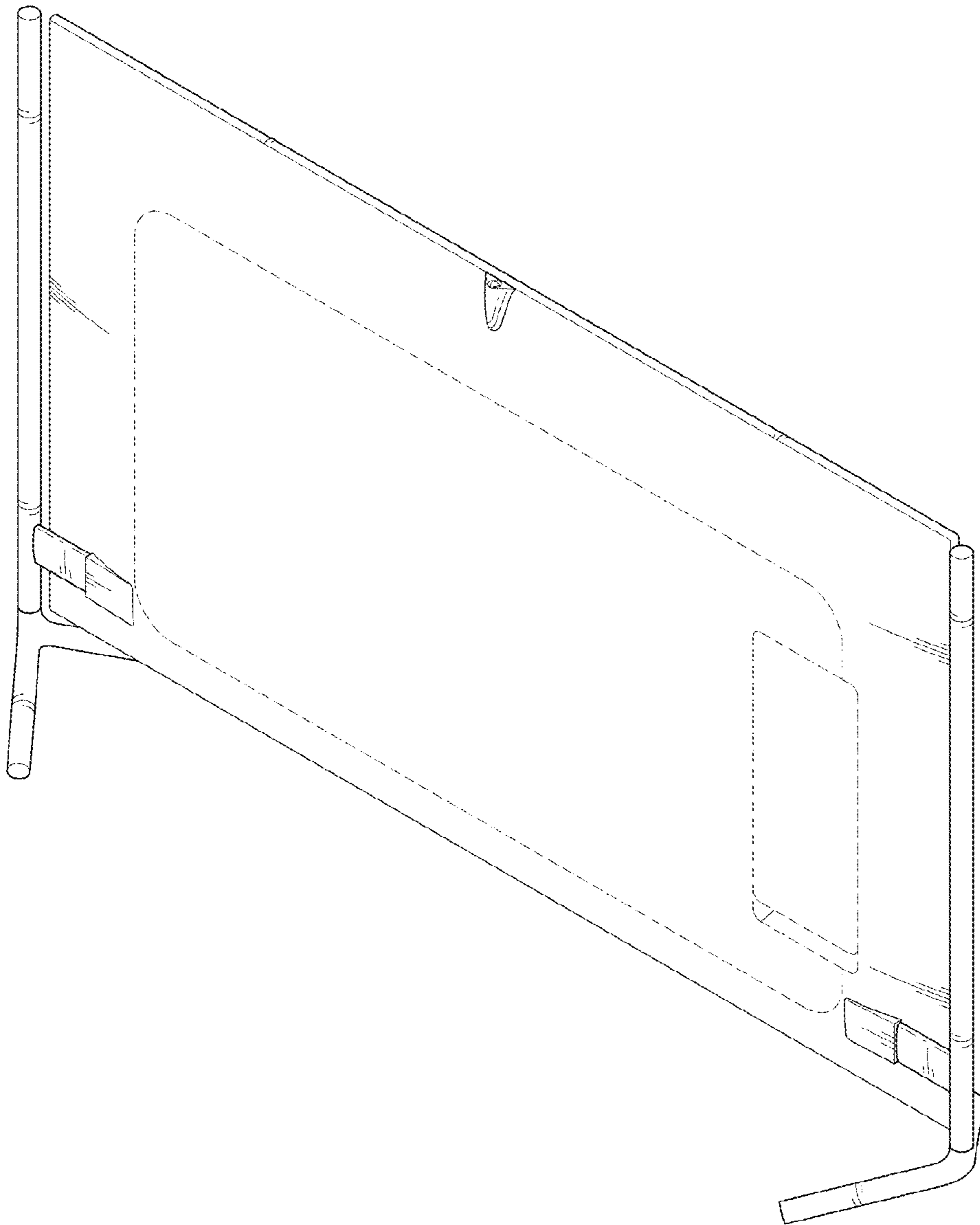

FIG. 8

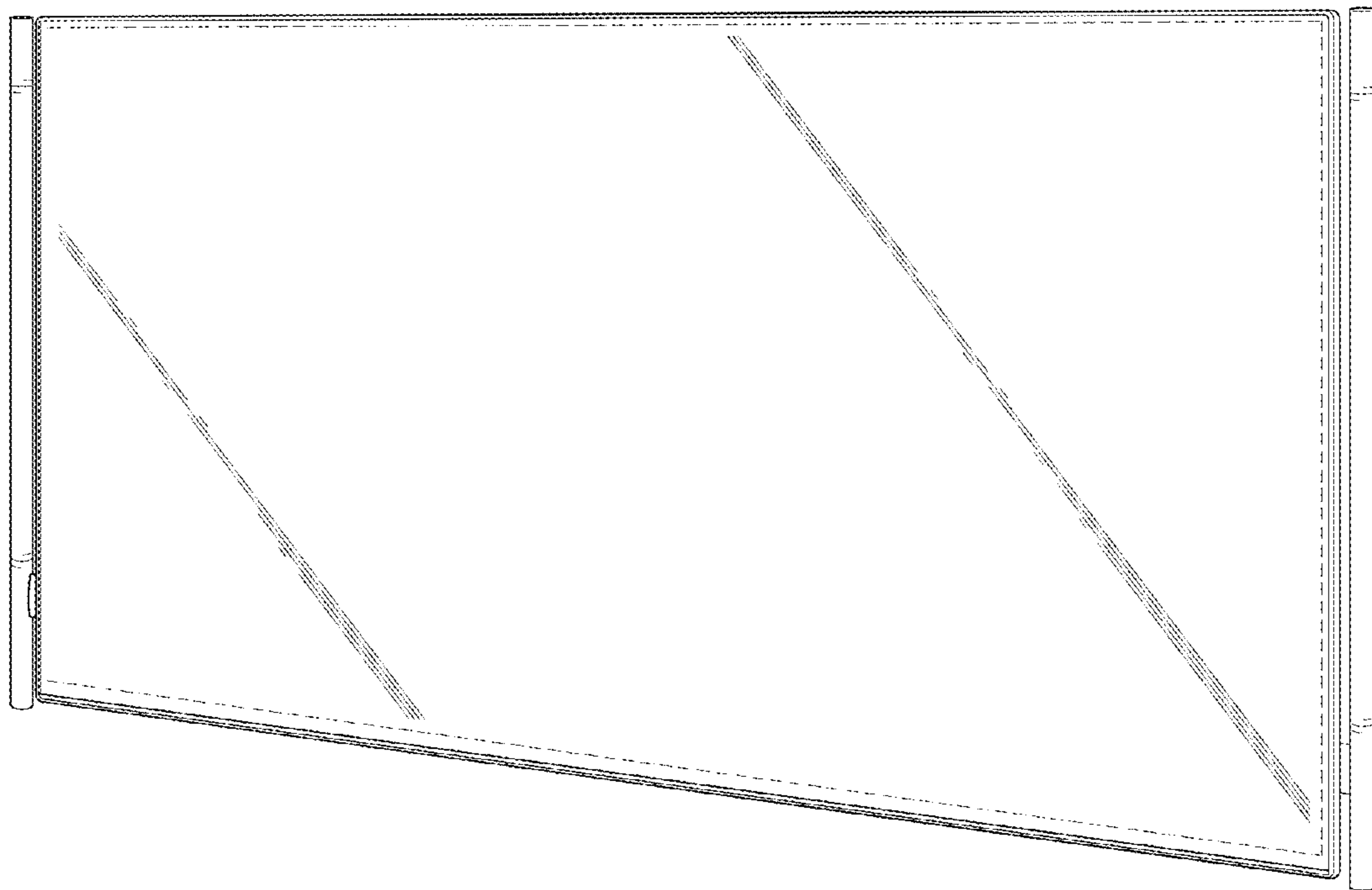

FIG. 9

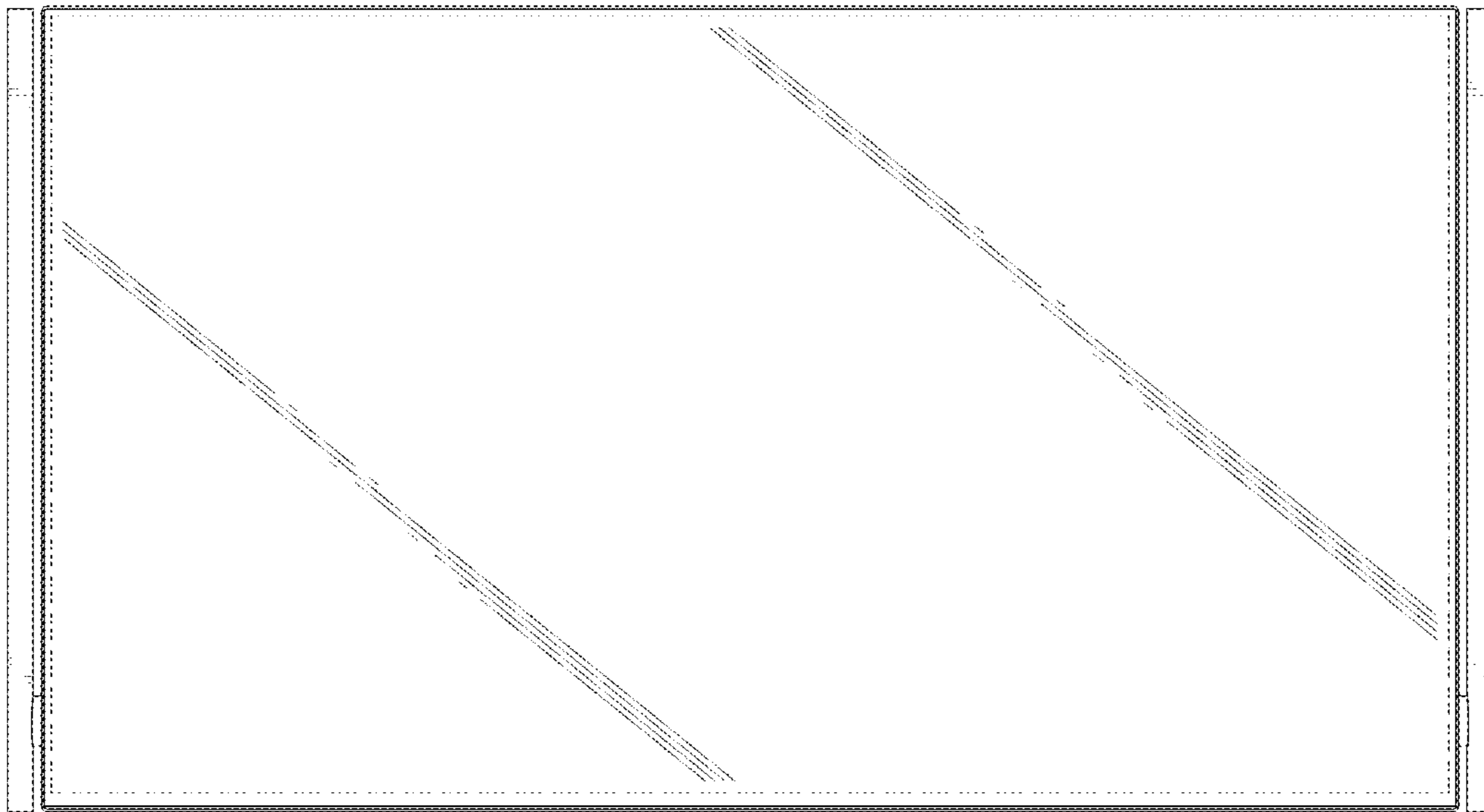

FIG. 10

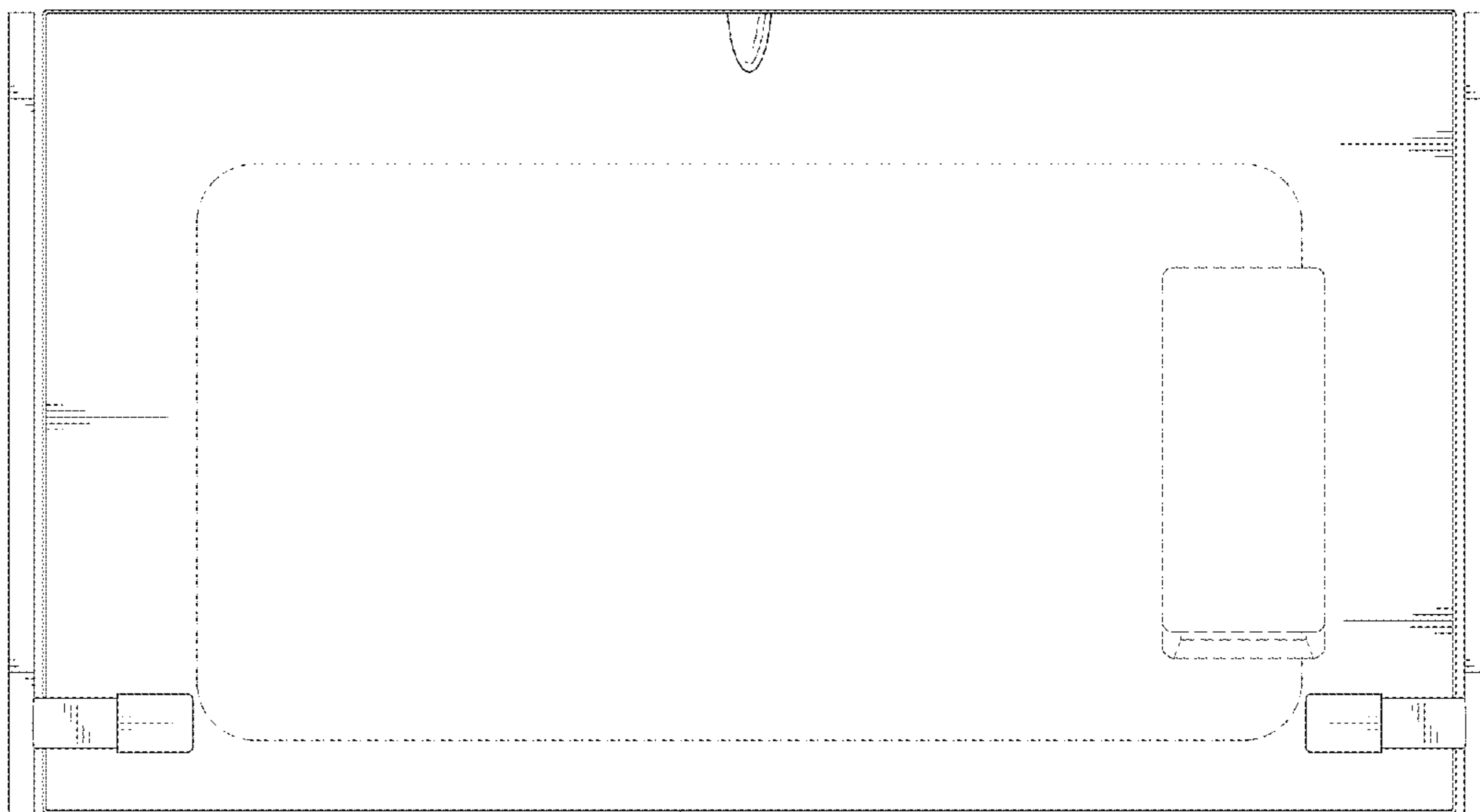

FIG. 11

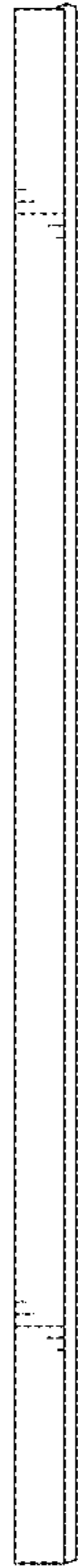

FIG. 12



FIG. 13

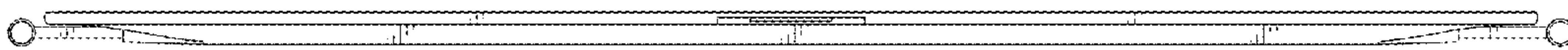

FIG. 14

