



US00D723439S

(12) **United States Design Patent**
Milbank

(10) **Patent No.:** **US D723,439 S**
(45) **Date of Patent:** **** Mar. 3, 2015**

(54) **MIRROR**

(71) Applicant: **Milenco Limited**, Milton Keynes,
Buckinghamshire (GB)

(72) Inventor: **Frederick Nigel Milbank**, Milton
Keynes (GB)

(73) Assignee: **Milenco Limited** (GB)

(**) Term: **14 Years**

(21) Appl. No.: **29/487,538**

(22) Filed: **Apr. 9, 2014**

(30) **Foreign Application Priority Data**

Oct. 9, 2013 (EM) 002322966

(51) **LOC (10) Cl.** **12-16**

(52) **U.S. Cl.**
USPC **D12/187**

(58) **Field of Classification Search**

USPC D12/187, 188-189; D6/300, 309;
359/838, 841-844, 868, 871, 866;
248/479-483, 475.1

See application file for complete search history.

(56) **References Cited**

U.S. PATENT DOCUMENTS

4,991,814 A * 2/1991 Schmidt et al. 248/479
D575,710 S * 8/2008 Zimmer et al. D12/187
D579,840 S * 11/2008 Scott D12/187
7,621,555 B2 * 11/2009 Wilkinson 280/477

D647,444 S * 10/2011 Manukyan et al. D12/187
D693,281 S 11/2013 Milbank
2005/0237643 A1 * 10/2005 Wu 359/871

FOREIGN PATENT DOCUMENTS

GB 4000160 6/2007
GB 2444919 5/2008
GB 2488775 12/2012

* cited by examiner

Primary Examiner — Katrina A Betton

(74) *Attorney, Agent, or Firm* — Bryant J. Keller; Kirton
McConkie

(57) **CLAIM**

The ornamental design for a mirror, as shown and described.

DESCRIPTION

FIG. 1 is a front, left side perspective view showing my new design thereof;
FIG. 2 is a back, right side perspective view thereof;
FIG. 3 is a front elevation view thereof;
FIG. 4 is a back elevation view thereof;
FIG. 5 is a top plan view thereof;
FIG. 6 is a bottom plan view thereof;
FIG. 7 is a left side elevation view thereof;
FIG. 8 is a right side elevation view thereof; and,
FIG. 9 is a front, left side perspective view thereof, wherein the mirror is coupled with a representative embodiment of an optional clamp.
The broken lines showing a potential screwdriver slot and the optional clamp that is coupled with the mirror are for environmental purposes only and form no part of the claimed design.

1 Claim, 5 Drawing Sheets

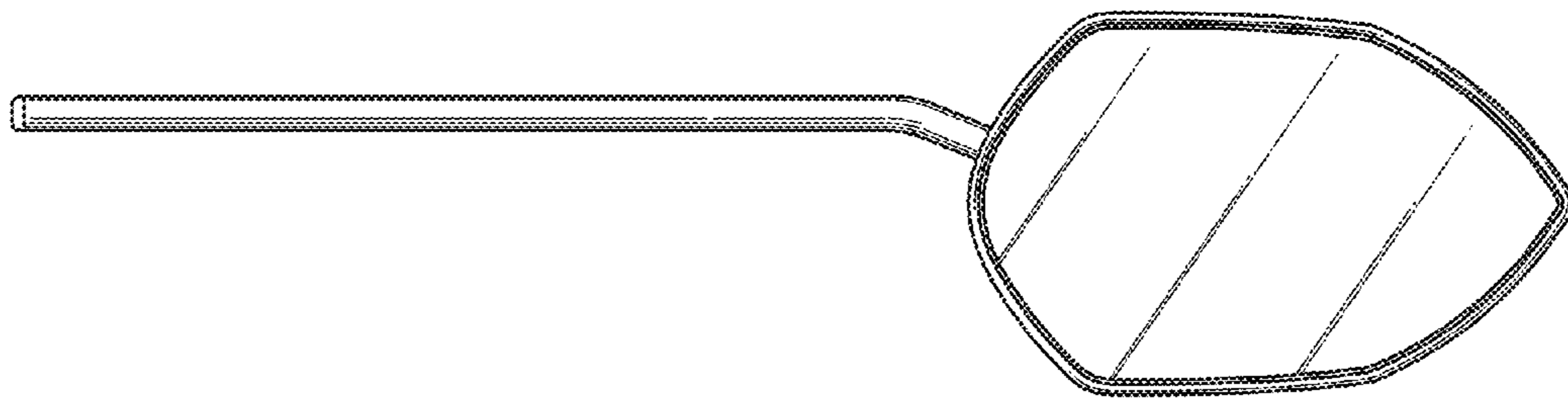

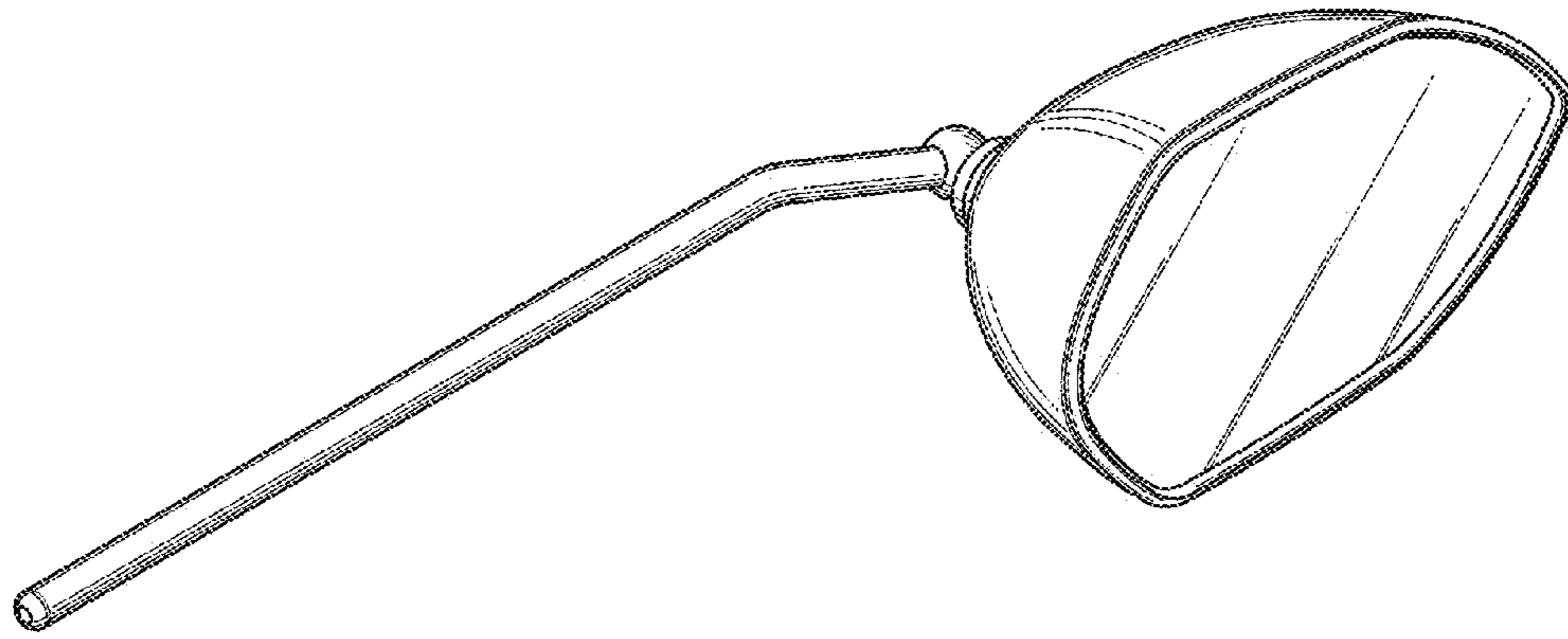

Fig. 1

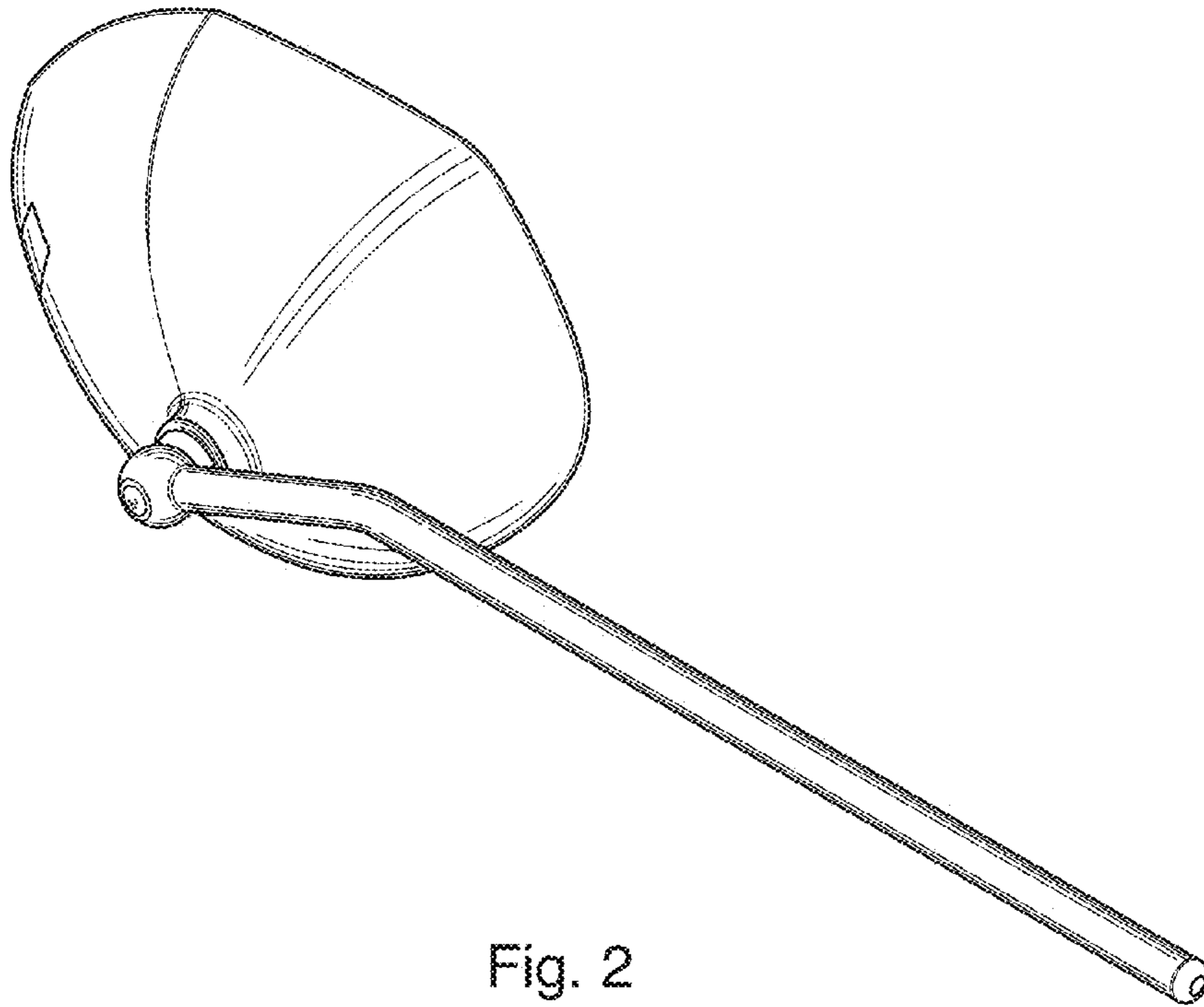

Fig. 2

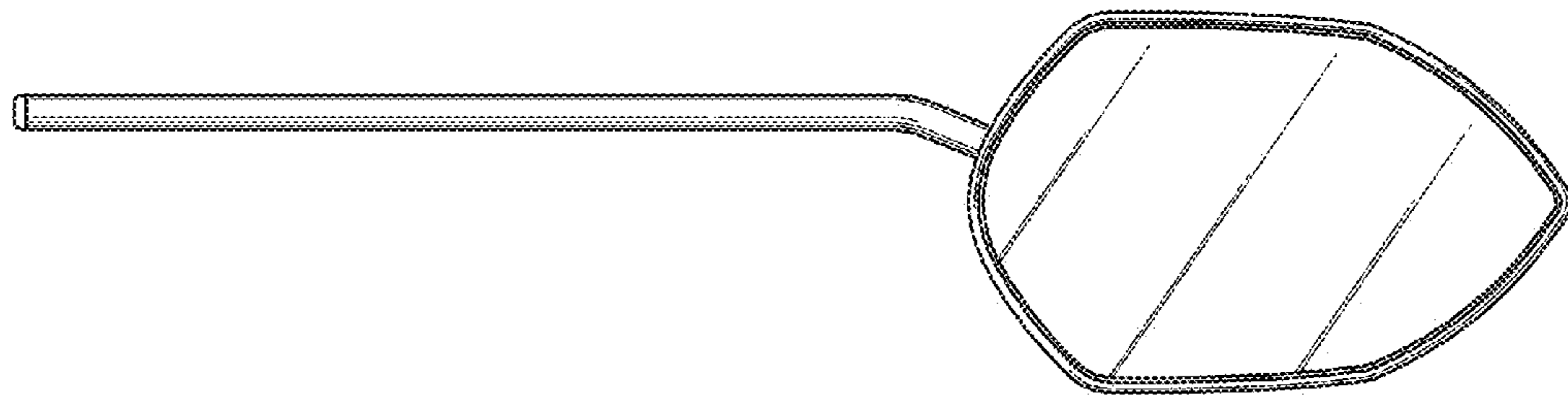

Fig. 3

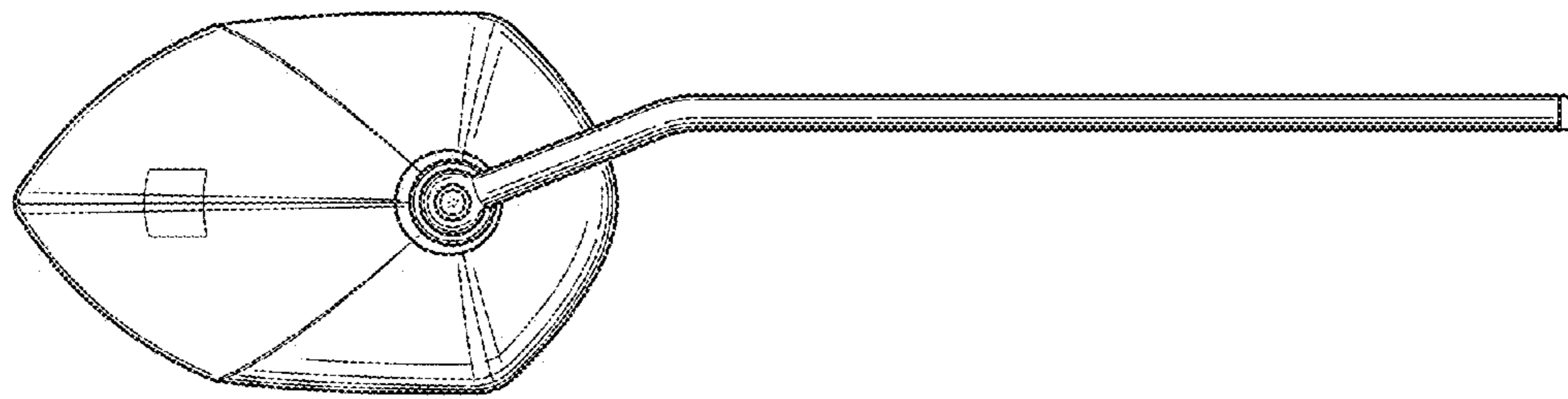

Fig. 4

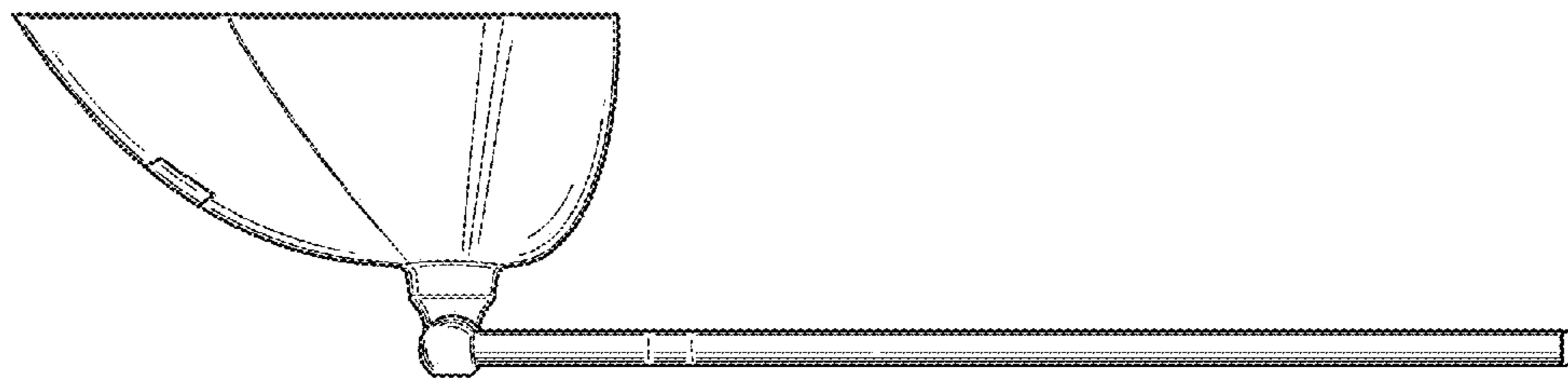

Fig. 5

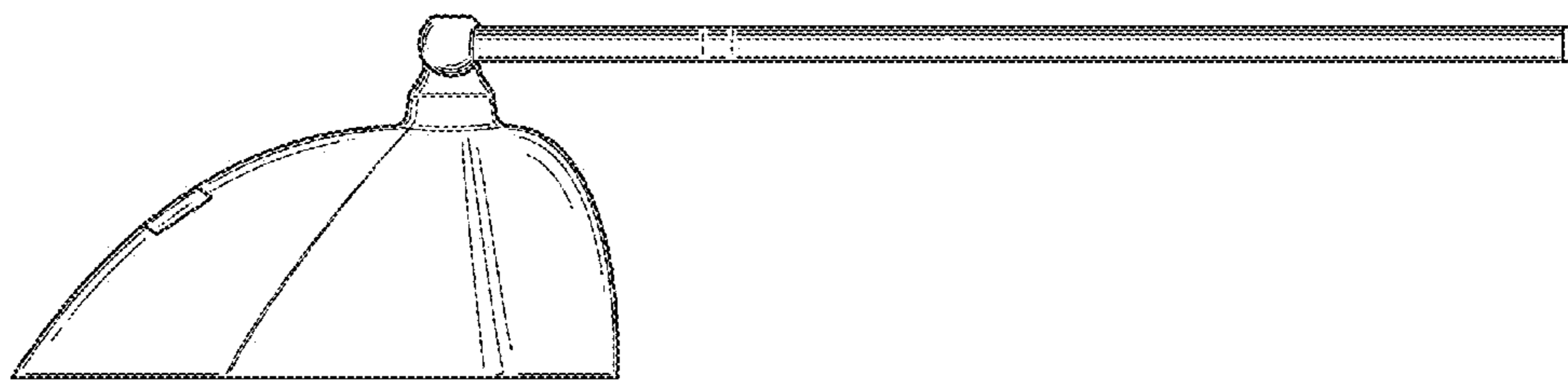

Fig. 6

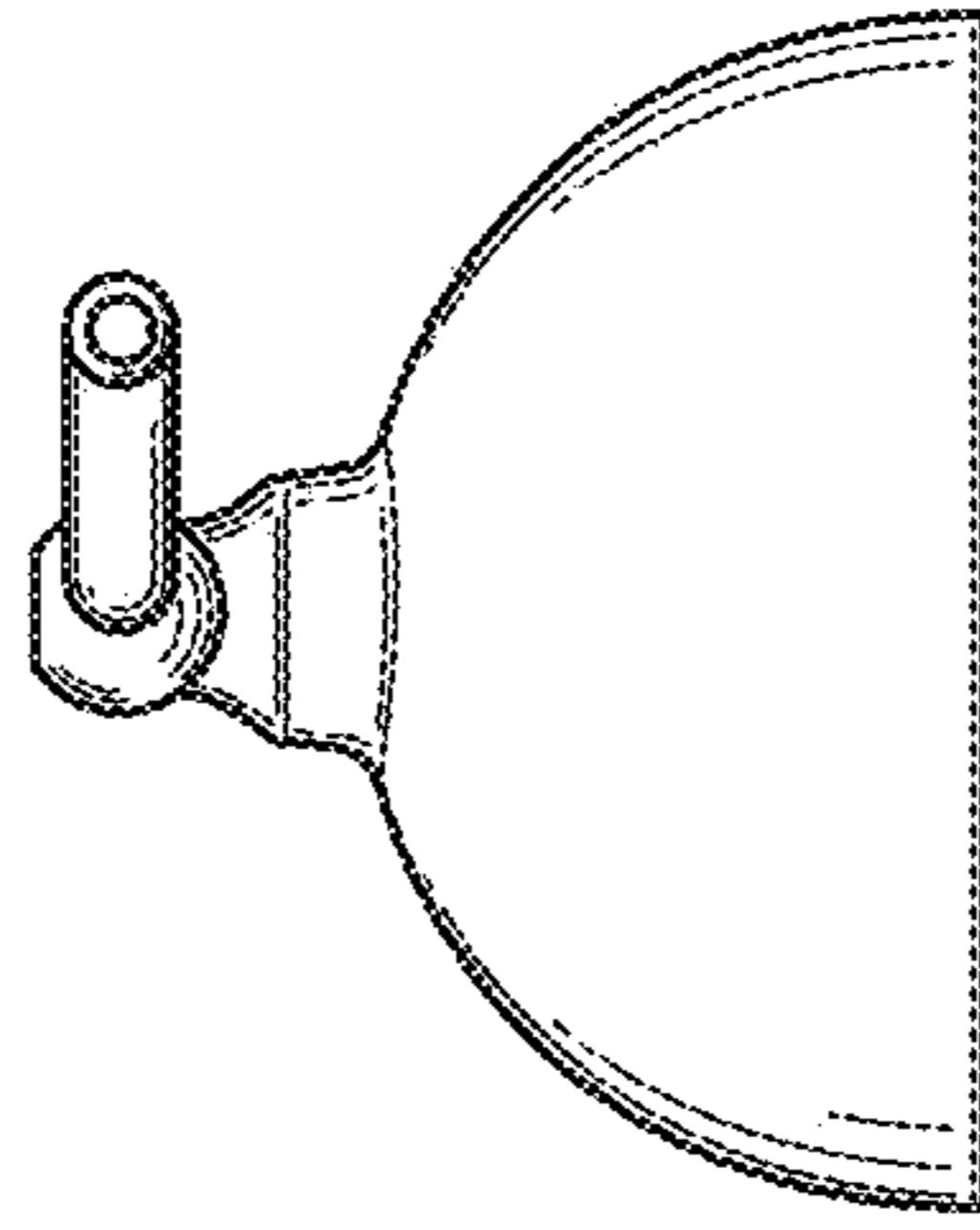

Fig. 7

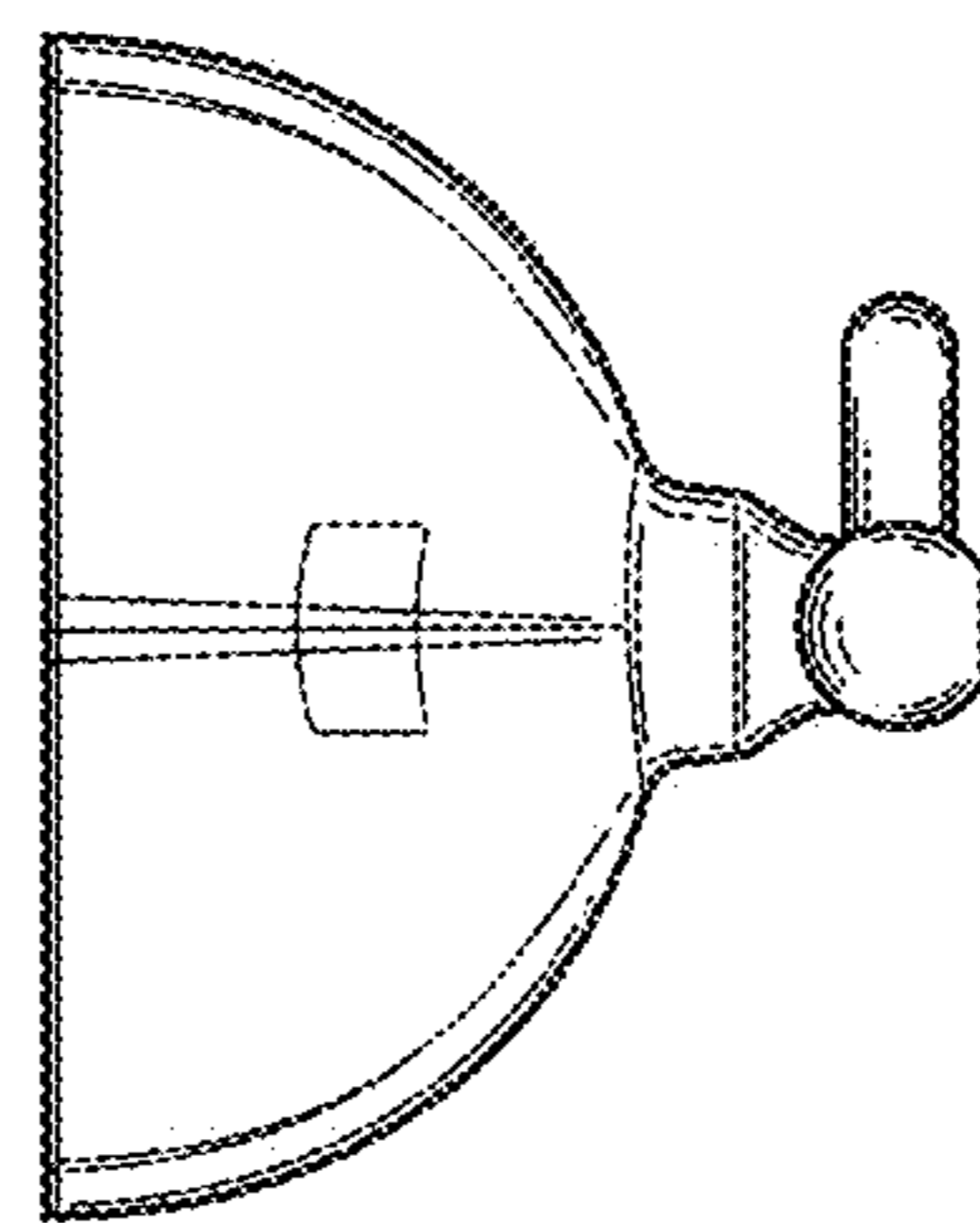

Fig. 8

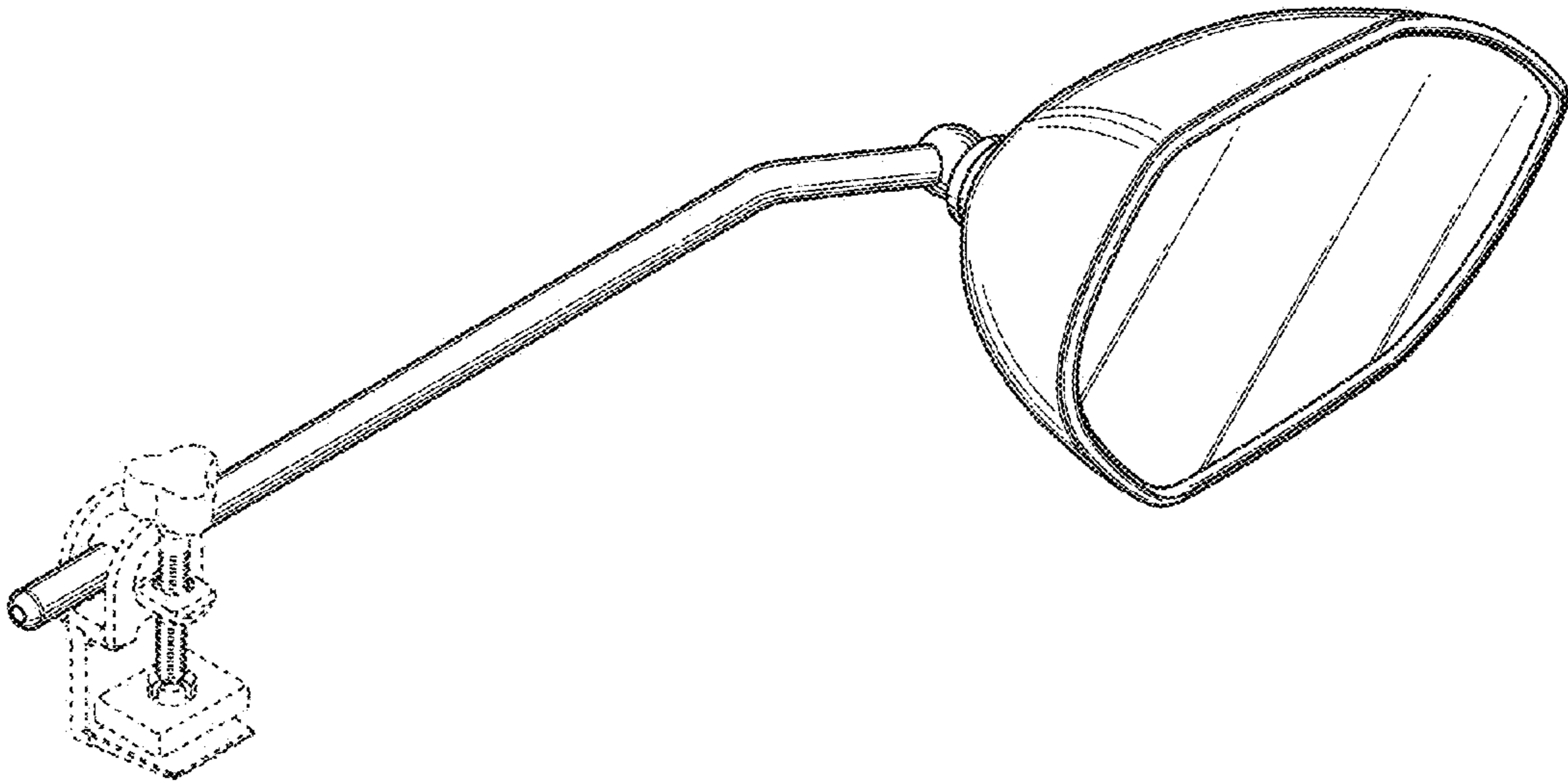

Fig. 9