



US00D723379S

(12) **United States Design Patent**  
**Shirley**

(10) **Patent No.:** **US D723,379 S**  
(45) **Date of Patent:** **\*\* Mar. 3, 2015**

- (54) **BOTTLE WITH FISH SHAPE**
- (71) Applicant: **Dart Industries Inc.**, Orlando, FL (US)
- (72) Inventor: **Nathan E. Shirley**, Orlando, FL (US)
- (73) Assignee: **Dart Industries Inc.**, Orlando, FL (US)
- (\*\*) Term: **14 Years**
- (21) Appl. No.: **29/485,559**
- (22) Filed: **Mar. 20, 2014**
- (51) **LOC (10) Cl.** ..... **09-01**
- (52) **U.S. Cl.**  
USPC ..... **D9/606**
- (58) **Field of Classification Search**  
CPC ..... B65D 67/00  
USPC ..... D7/514-515, 517, 519-520, 451;  
D9/600-601, 606, 630; 206/457, 527;  
215/381-384, 400; D11/158; D21/599,  
D21/650  
See application file for complete search history.

- D351,340 S \* 10/1994 Drummond et al. .... D9/617
- D399,733 S \* 10/1998 Hand ..... D9/630
- D444,378 S \* 7/2001 Hand ..... D21/650
- D447,049 S \* 8/2001 Vandervort et al. .... D9/606
- D520,407 S \* 5/2006 Zhang ..... D21/599
- D564,049 S \* 3/2008 Johnson et al. .... D21/599

\* cited by examiner

*Primary Examiner* — Sandra Morris

(74) *Attorney, Agent, or Firm* — Taylor J. Ross

(57) **CLAIM**

The ornamental design for a bottle with fish shape, as shown and described.

**DESCRIPTION**

FIG. 1 is a top, front and left side perspective view of a bottle with fish shape showing my new design;  
 FIG. 2 is a bottom, rear and right side perspective view thereof;  
 FIG. 3 is a top plan view thereof;  
 FIG. 4 is a bottom plan view thereof;  
 FIG. 5 is a front elevation view thereof;  
 FIG. 6 is a rear elevation view thereof;  
 FIG. 7 is a left side elevation view, the right side being a mirror image thereof;  
 FIG. 8 is a cross-sectional view along line 8-8 of FIG. 3; and,  
 FIG. 9 is a cross-sectional view along line 9-9 of FIG. 3.

**1 Claim, 5 Drawing Sheets**

(56) **References Cited**

**U.S. PATENT DOCUMENTS**

- D148,906 S \* 3/1948 Blecher ..... D21/599
- D259,334 S \* 5/1981 Sztuden ..... D9/606
- D322,346 S \* 12/1991 Thompson ..... D21/599
- D349,847 S \* 8/1994 Avins ..... D9/630

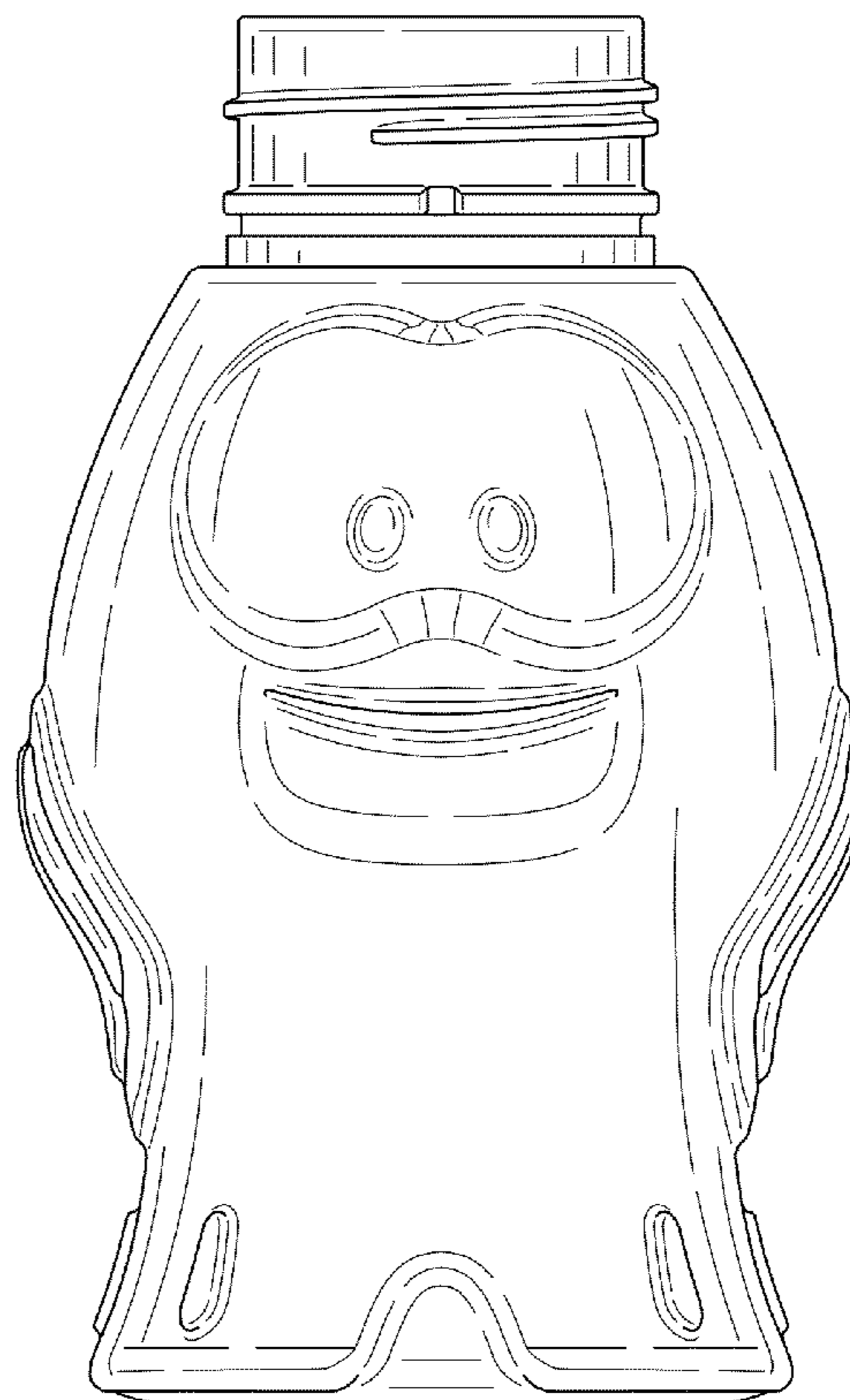
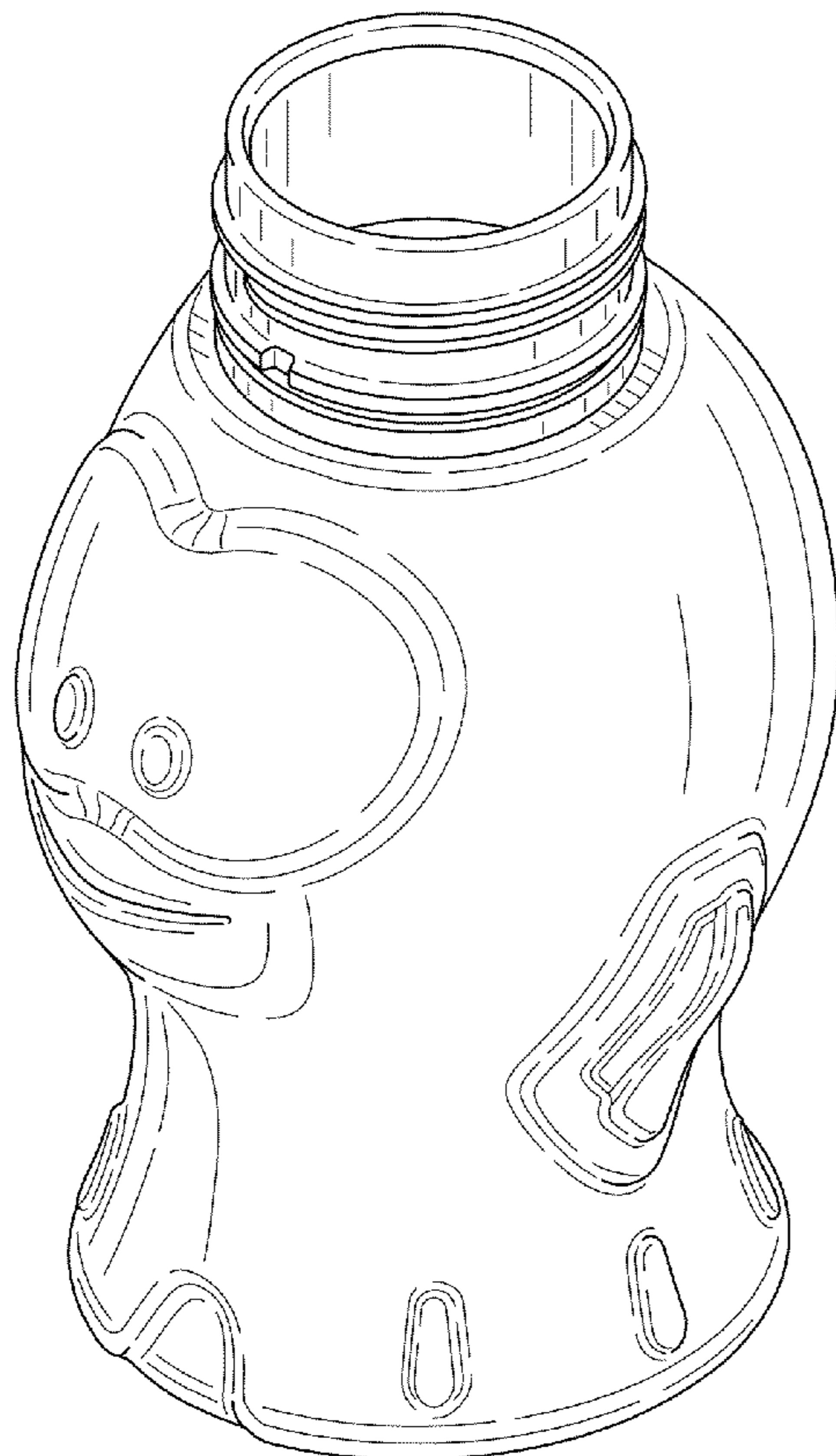

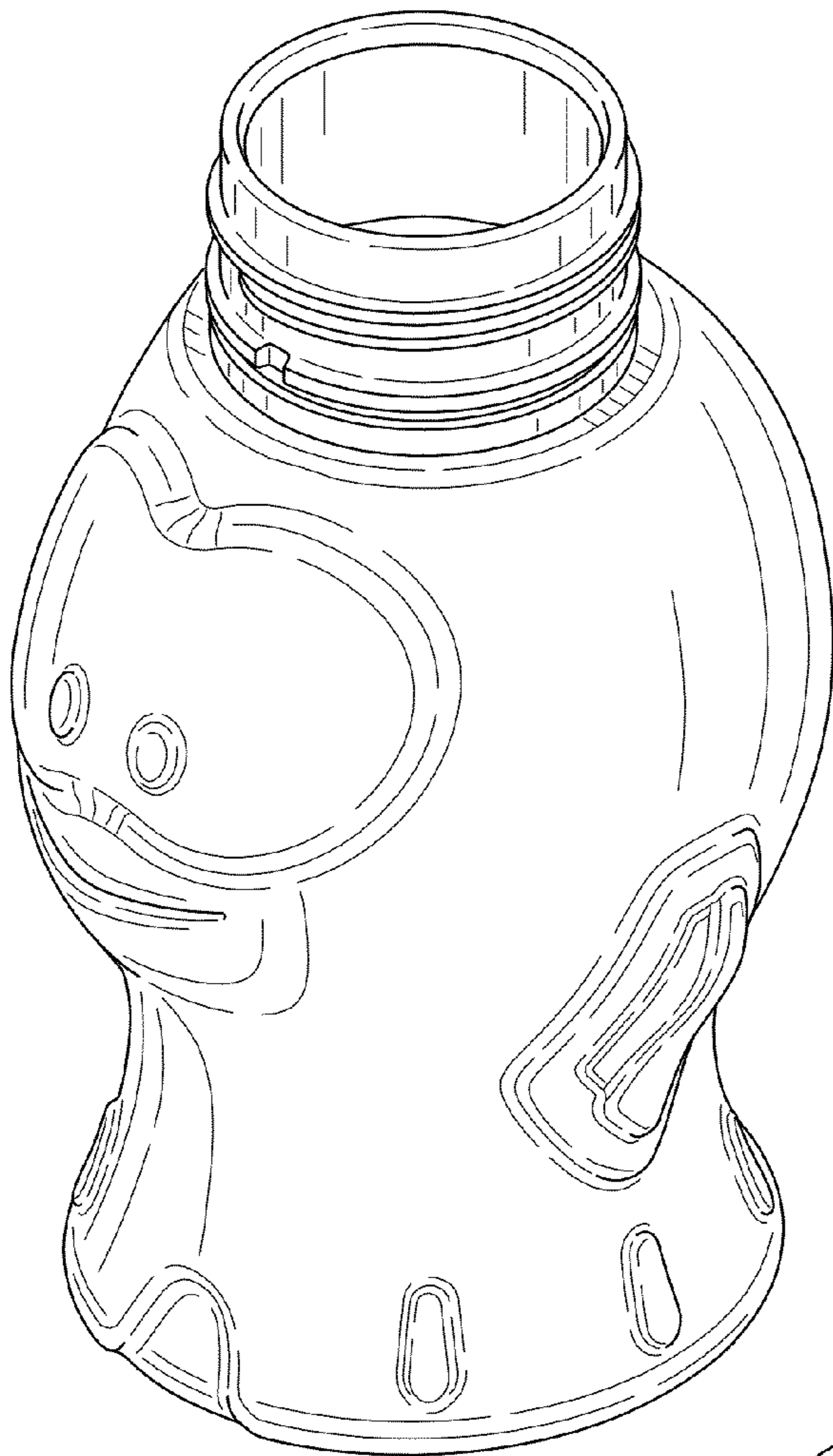

FIG. 1

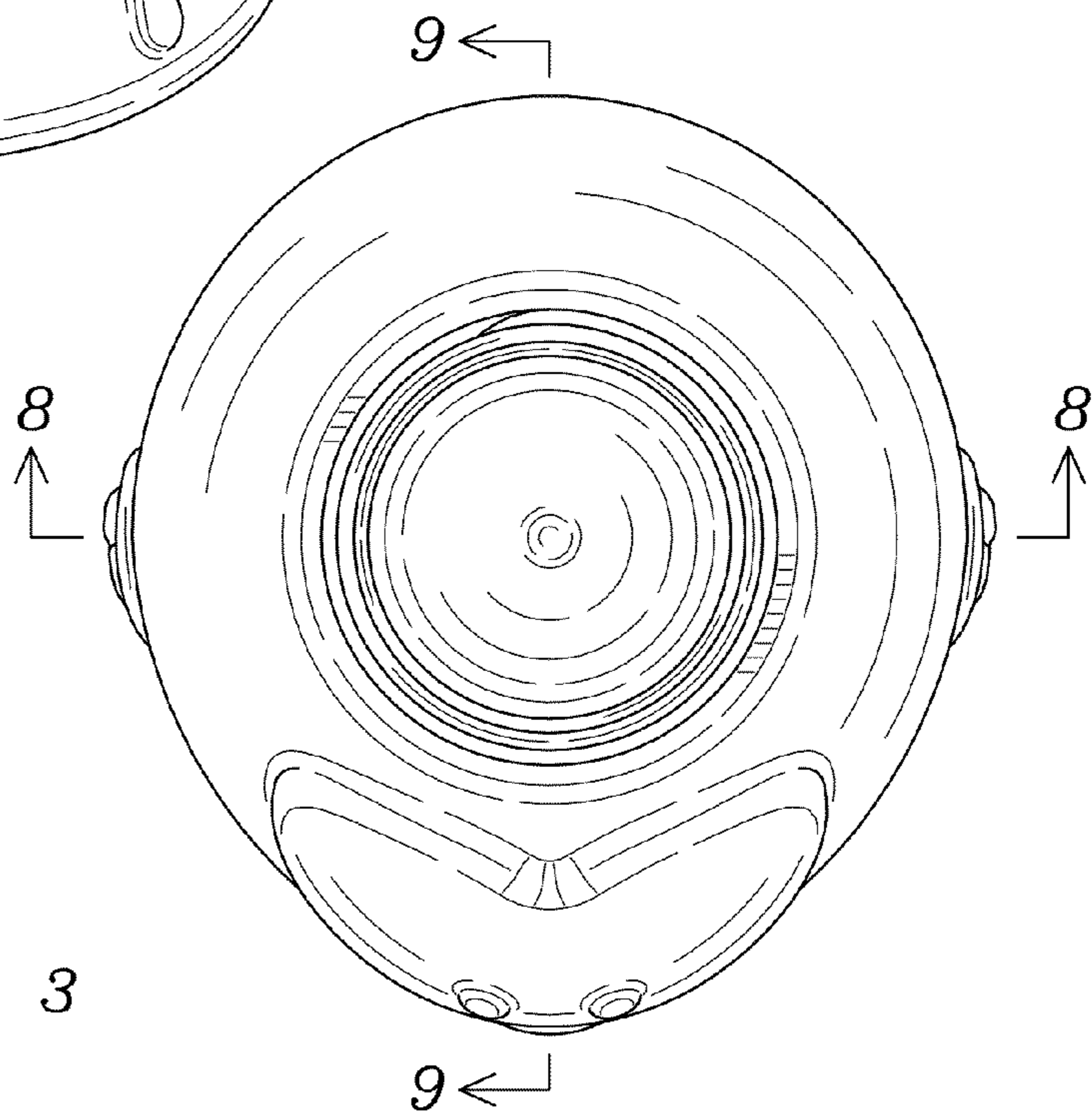

FIG. 3

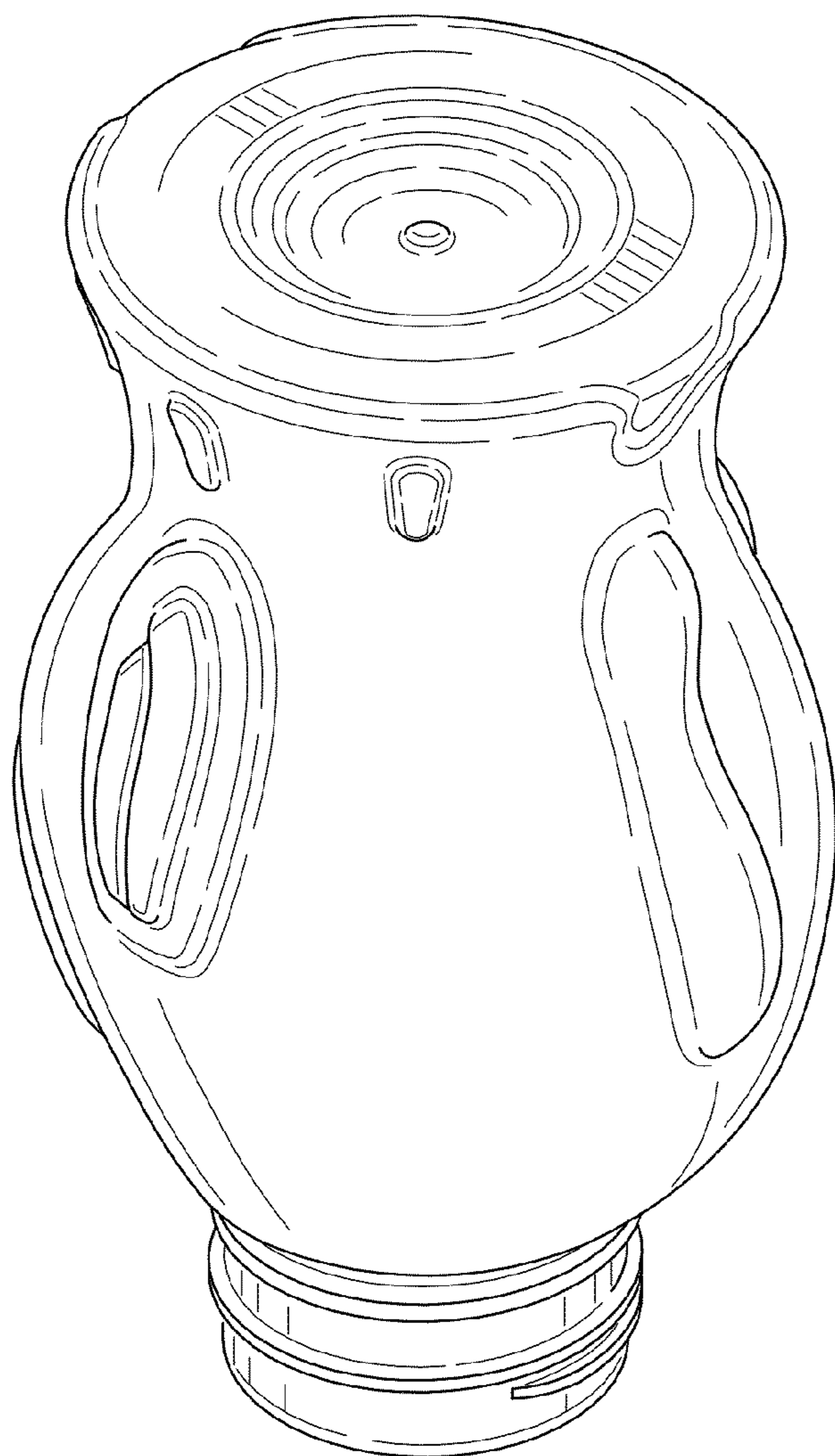

FIG. 2

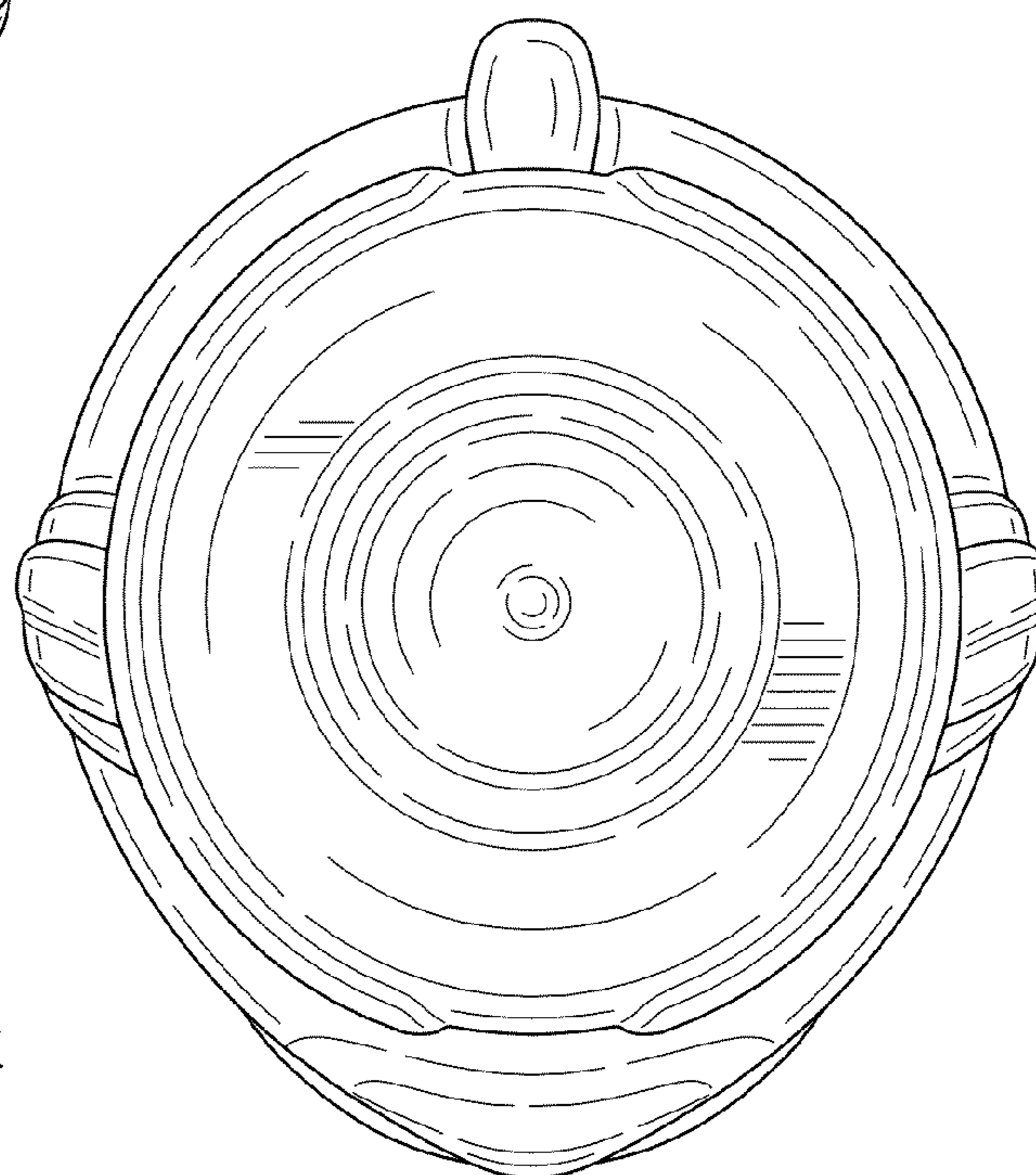

FIG. 4

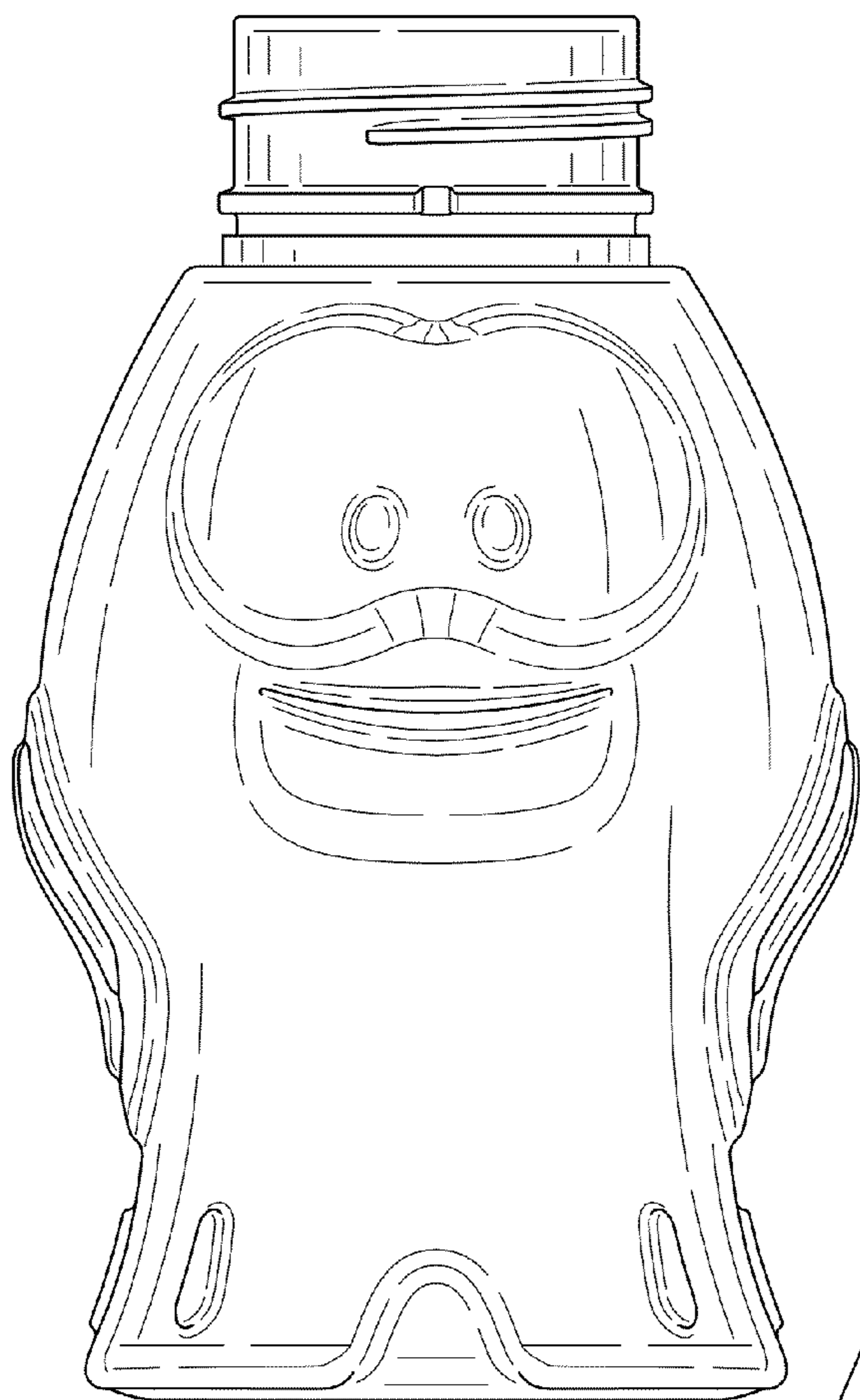

FIG. 5

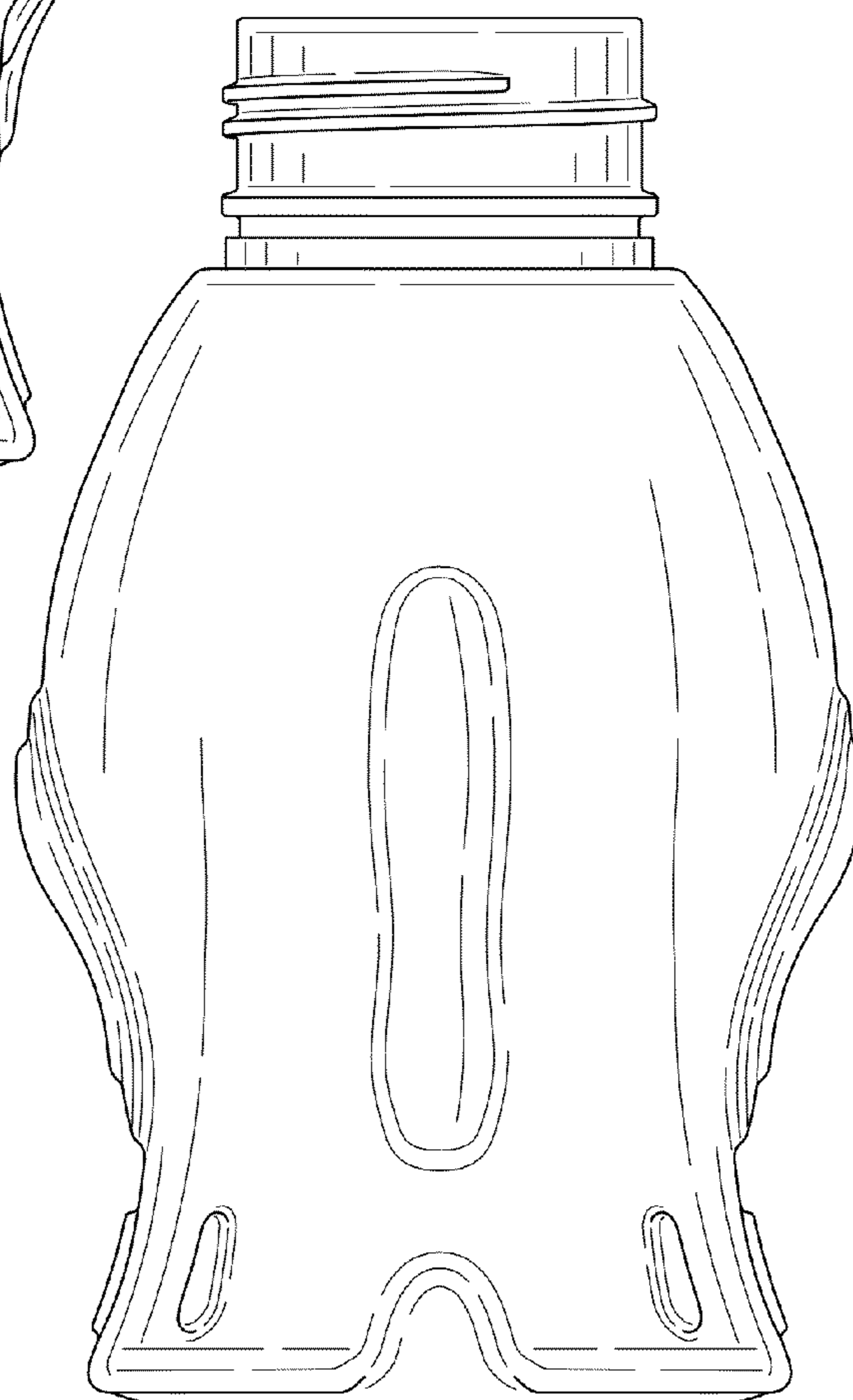

FIG. 6

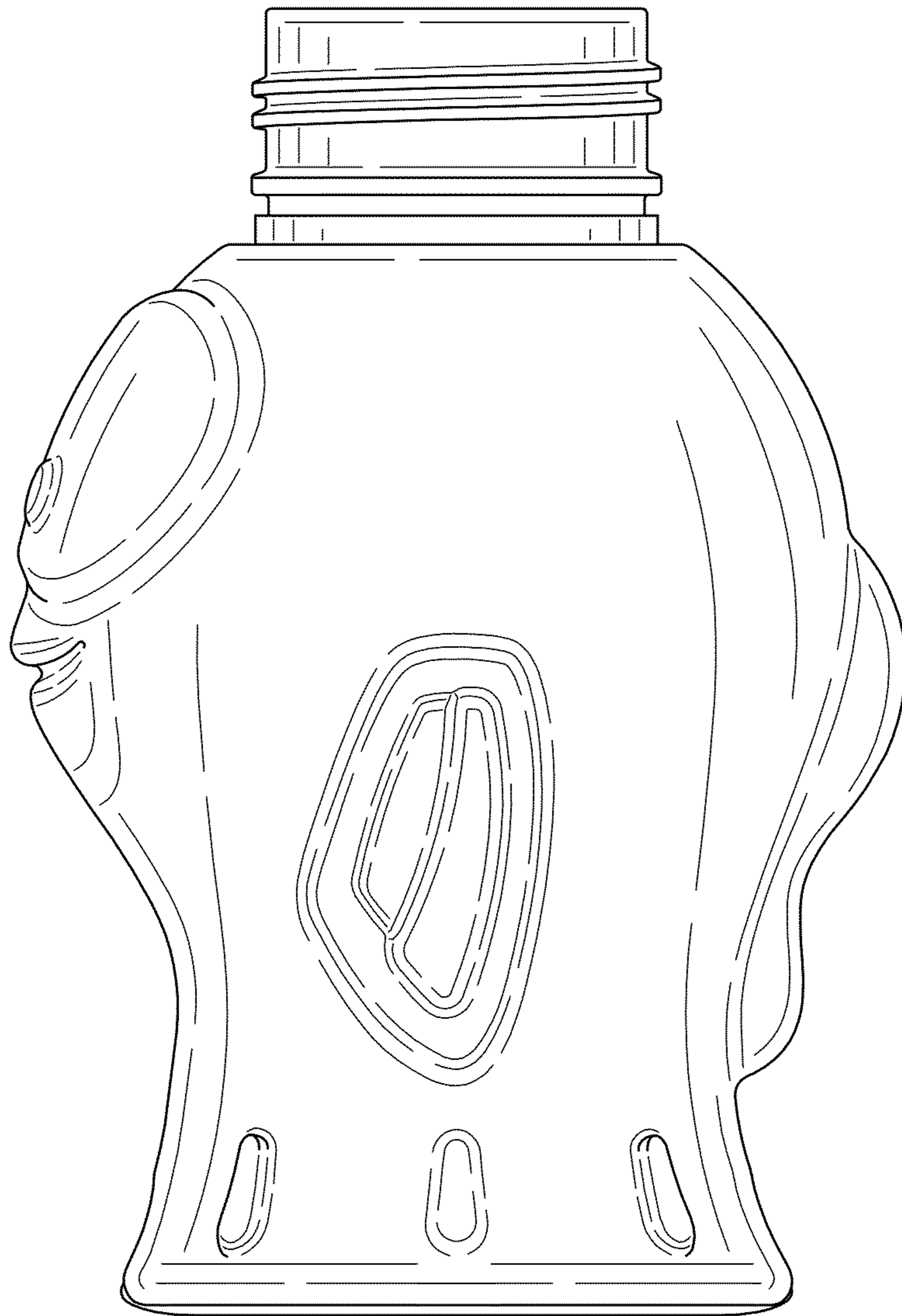

FIG. 7

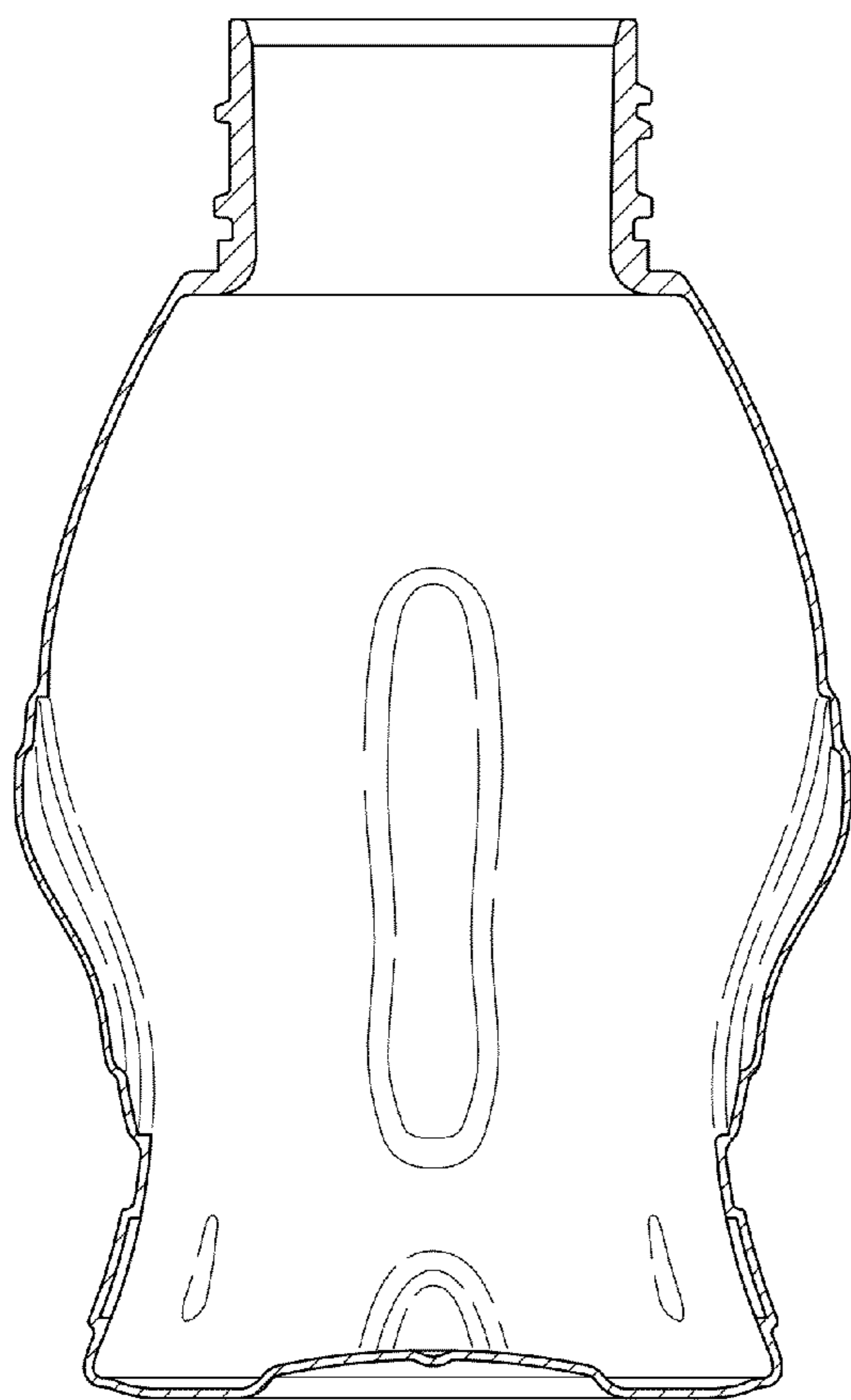

FIG. 8

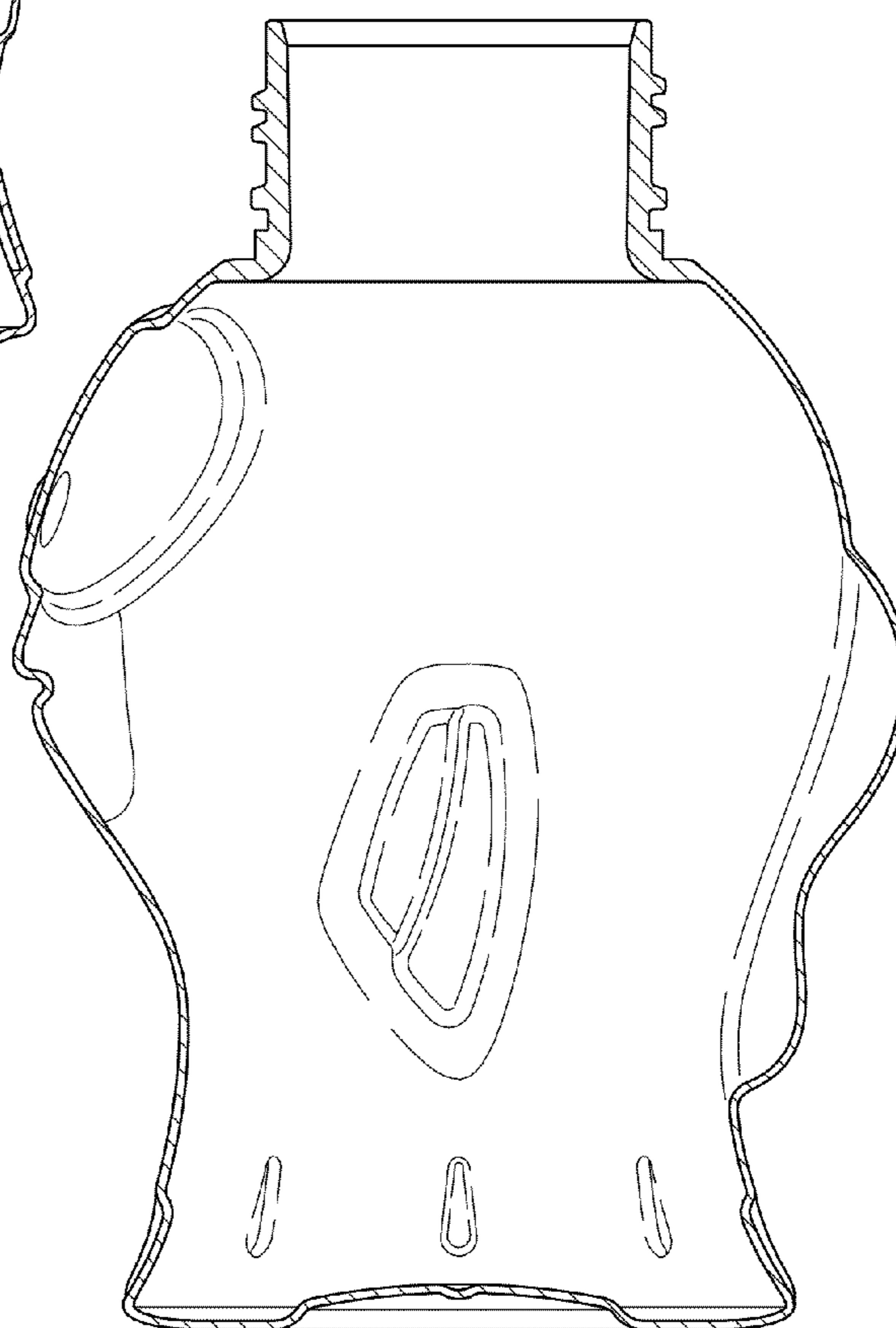

FIG. 9