



US00D723332S

(12) **United States Design Patent**
Steel

(10) **Patent No.:** **US D723,332 S**
(45) **Date of Patent:** **** Mar. 3, 2015**

- (54) **SHAKER MUG**
- (71) Applicant: **Jeffrey Steel**, Hoboken, NJ (US)
- (72) Inventor: **Jeffrey Steel**, Hoboken, NJ (US)
- (73) Assignee: **Cotapaxi Custom Design and Manufacturing LLC**, Carlstadt, NJ (US)
- (**) Term: **14 Years**
- (21) Appl. No.: **29/481,177**
- (22) Filed: **Feb. 3, 2014**
- (51) **LOC (10) Cl.** **07-01**
- (52) **U.S. Cl.**
USPC **D7/510**
- (58) **Field of Classification Search**
USPC D7/396.2, 507, 509, 510, 511;
D9/434-455, 524, 682, 685, 694;
215/200, 235, 236, 252, 254, 329,
215/355-364; 220/203.04-203.07, 220,
220/254.1, 254.4, 556, 703, 704, 705;
D6/542-545
See application file for complete search history.

D513,916 S *	1/2006	Namee	D7/300.1
D644,065 S *	8/2011	Llerena	D7/510
D646,919 S *	10/2011	Nilsson	D7/300.1
D666,047 S *	8/2012	Lin	D7/300.1
D677,121 S *	3/2013	Meyers et al.	D7/510
D687,661 S *	8/2013	Cetera et al.	D7/300.1
D692,276 S *	10/2013	Cetera et al.	D7/510
D699,996 S *	2/2014	De Leo	D7/300.1
8,672,164 B2 *	3/2014	Honeyghan	220/254.3
D702,503 S *	4/2014	Steel et al.	D7/510
8,844,746 B2 *	9/2014	Meyers et al.	220/264

* cited by examiner

Primary Examiner — Robert M Spear
Assistant Examiner — Marissa J Cash
(74) *Attorney, Agent, or Firm* — Steven E. Shapiro

(57) **CLAIM**
The ornamental design for a shaker mug, as shown and described.

DESCRIPTION

FIG. 1 is a top perspective view of a shaker mug;
FIG. 2 is a right side view of the shaker mug;
FIG. 3 is a left side view of the shaker mug;
FIG. 4 is a front view of the shaker mug;
FIG. 5 is a rear view of the shaker mug;
FIG. 6 is a top view of the shaker mug; and,
FIG. 7 is a bottom view of the shaker mug.
The broken lines shown in the drawings represent portions of the shaker mug that form no part of the claimed design.

1 Claim, 6 Drawing Sheets

- (56) **References Cited**
U.S. PATENT DOCUMENTS
D233,116 S * 10/1974 Swett D7/300.1
D510,235 S * 10/2005 Sorensen D7/510

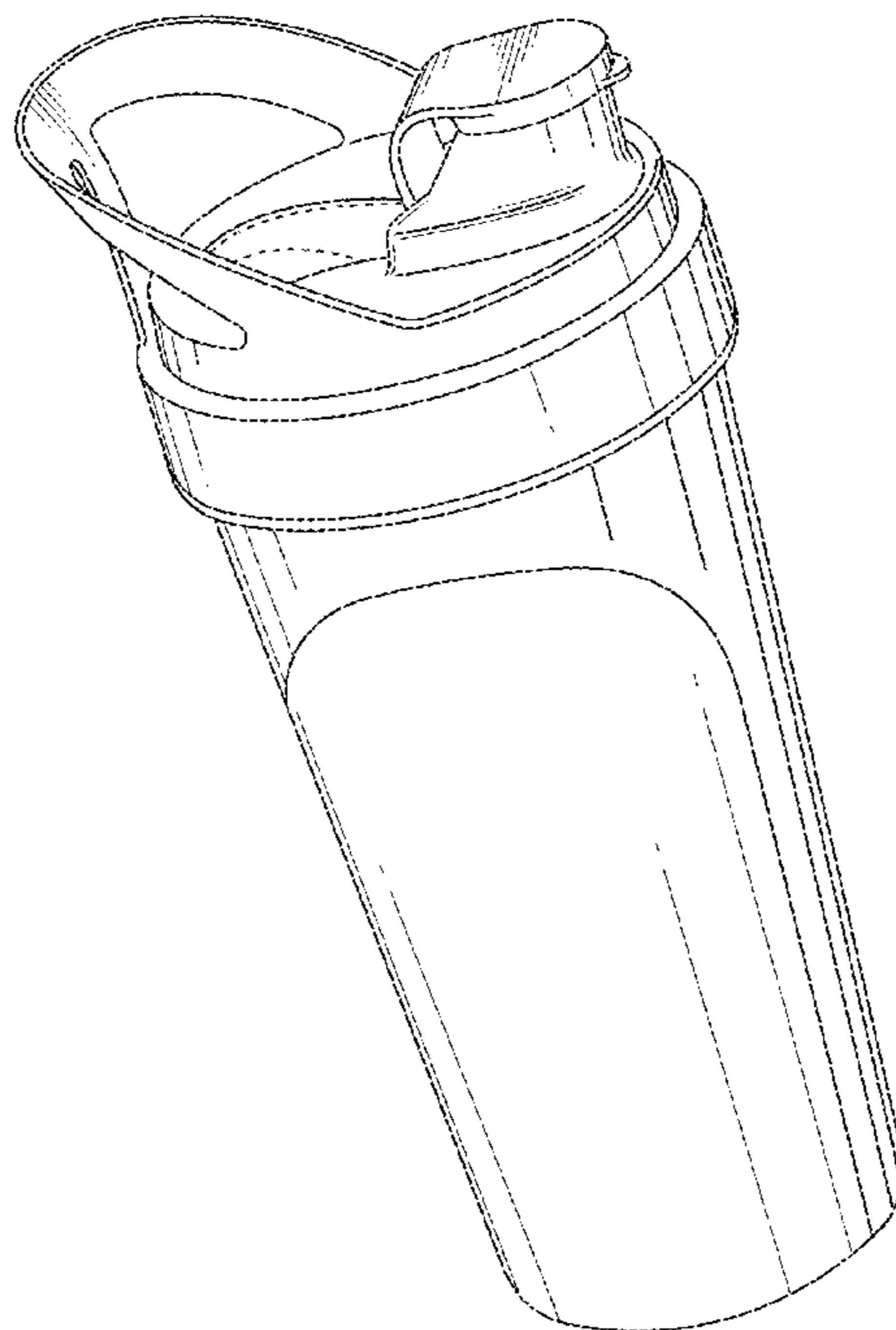

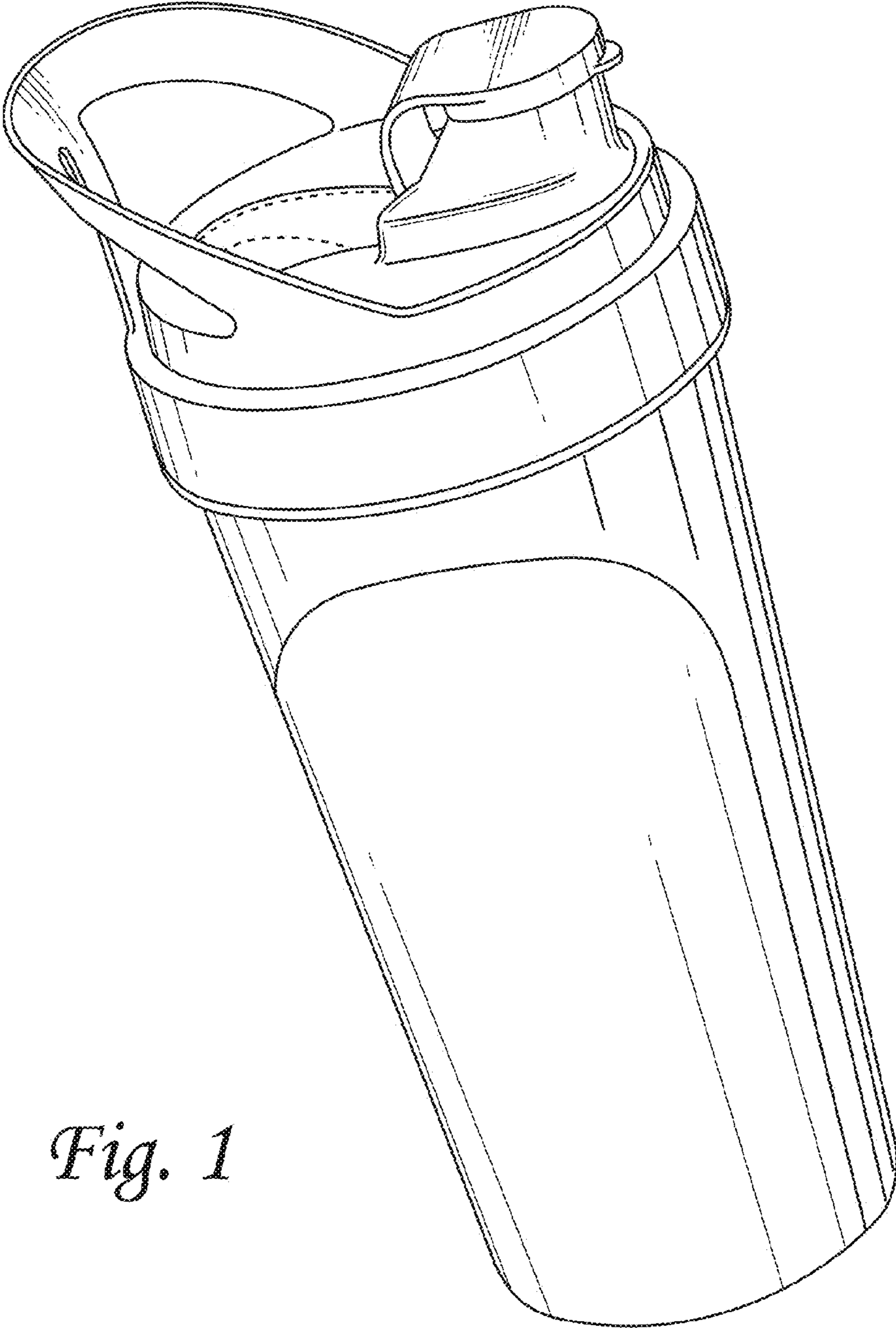

Fig. 1

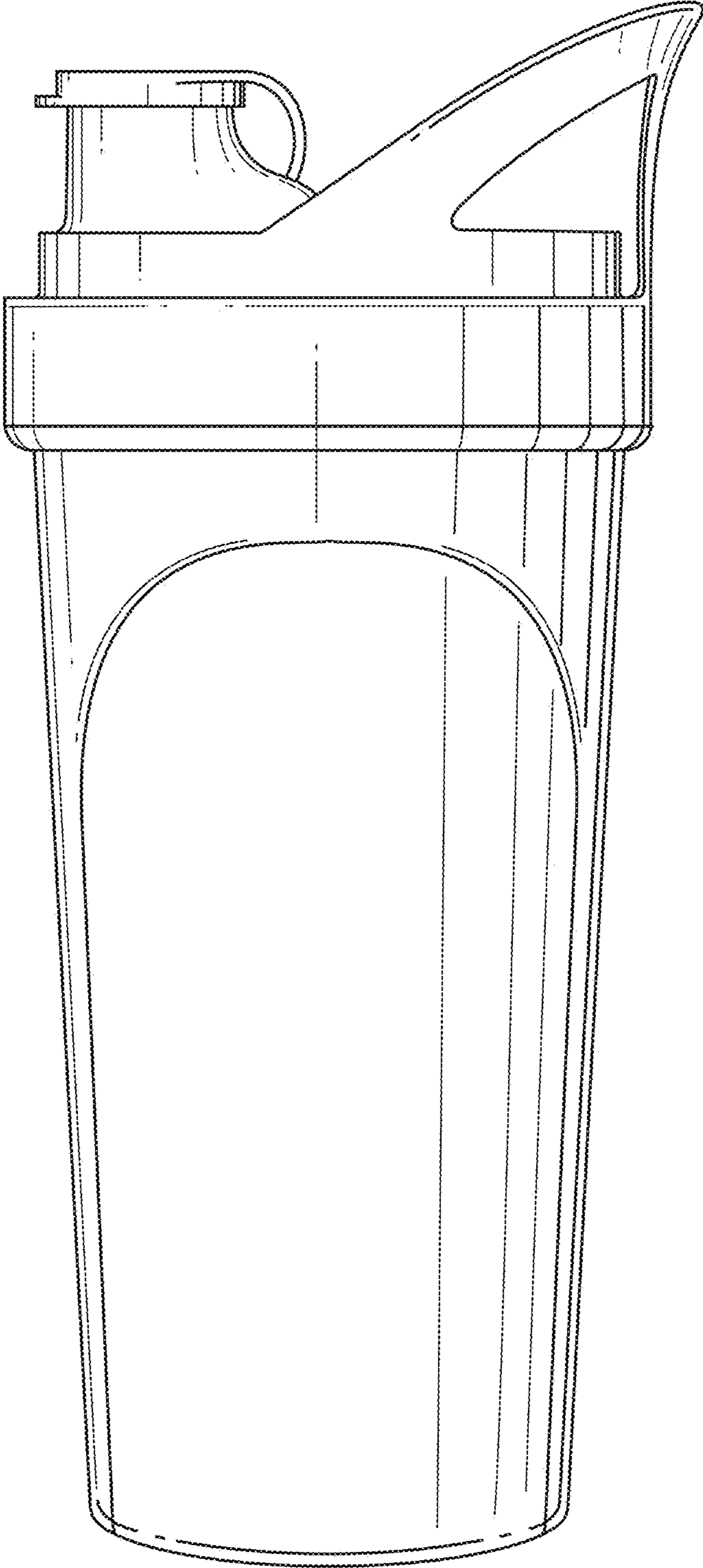

Fig. 2

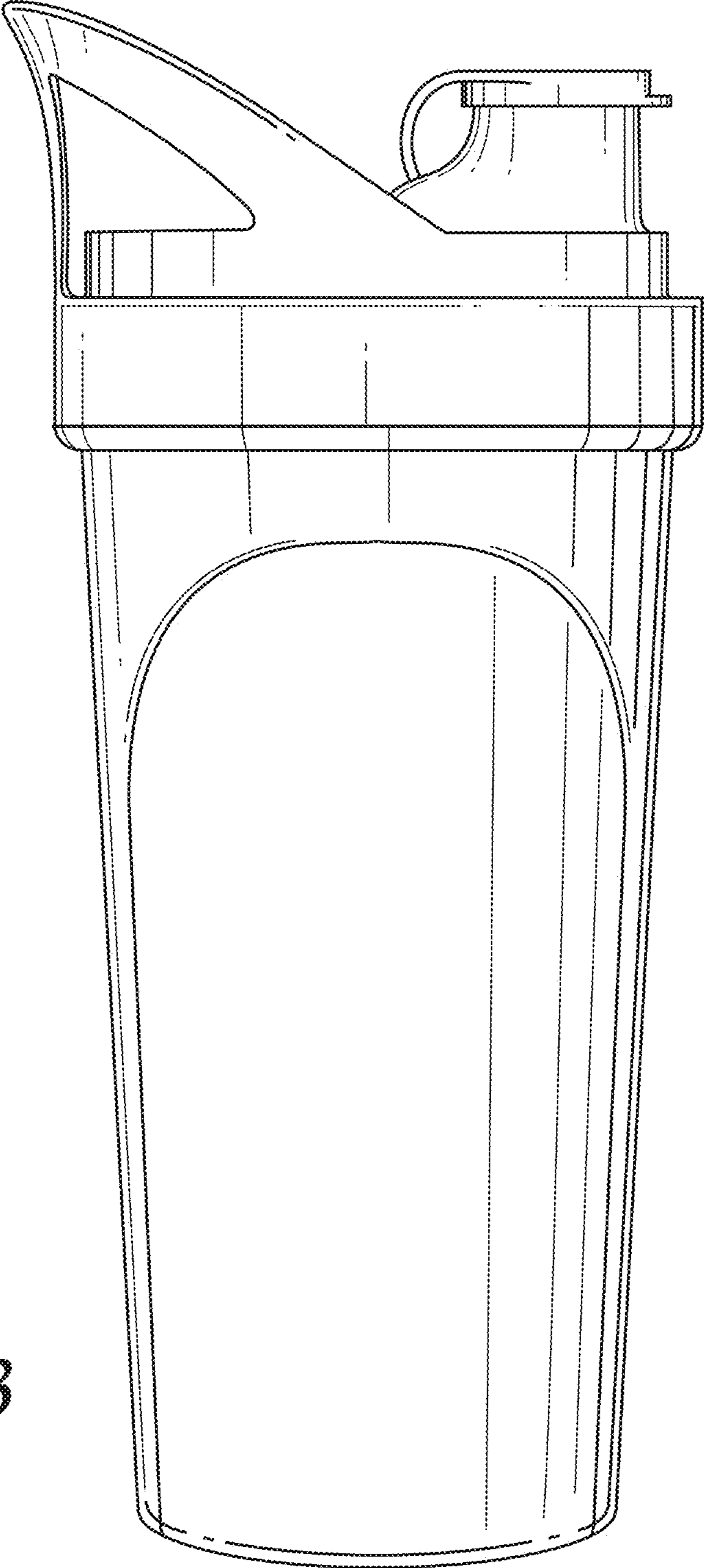

Fig. 3

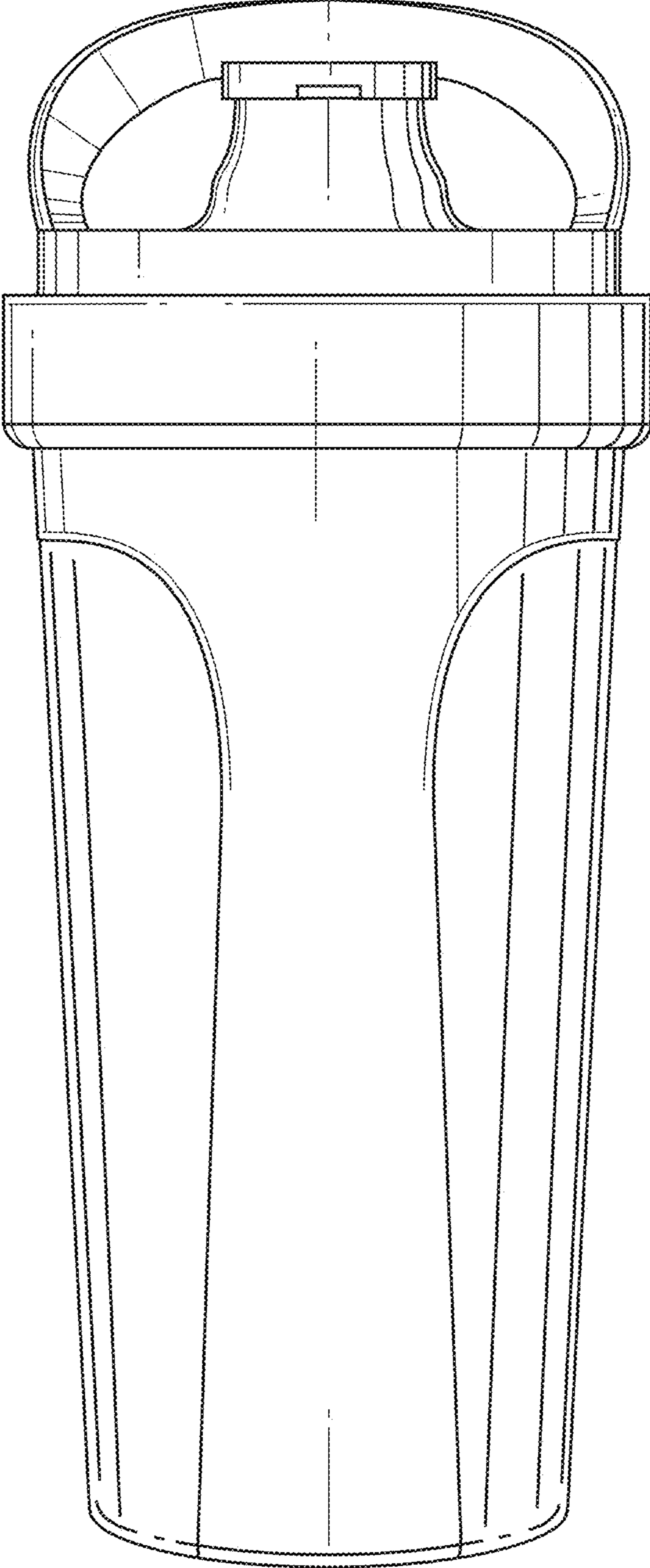

Fig. 4

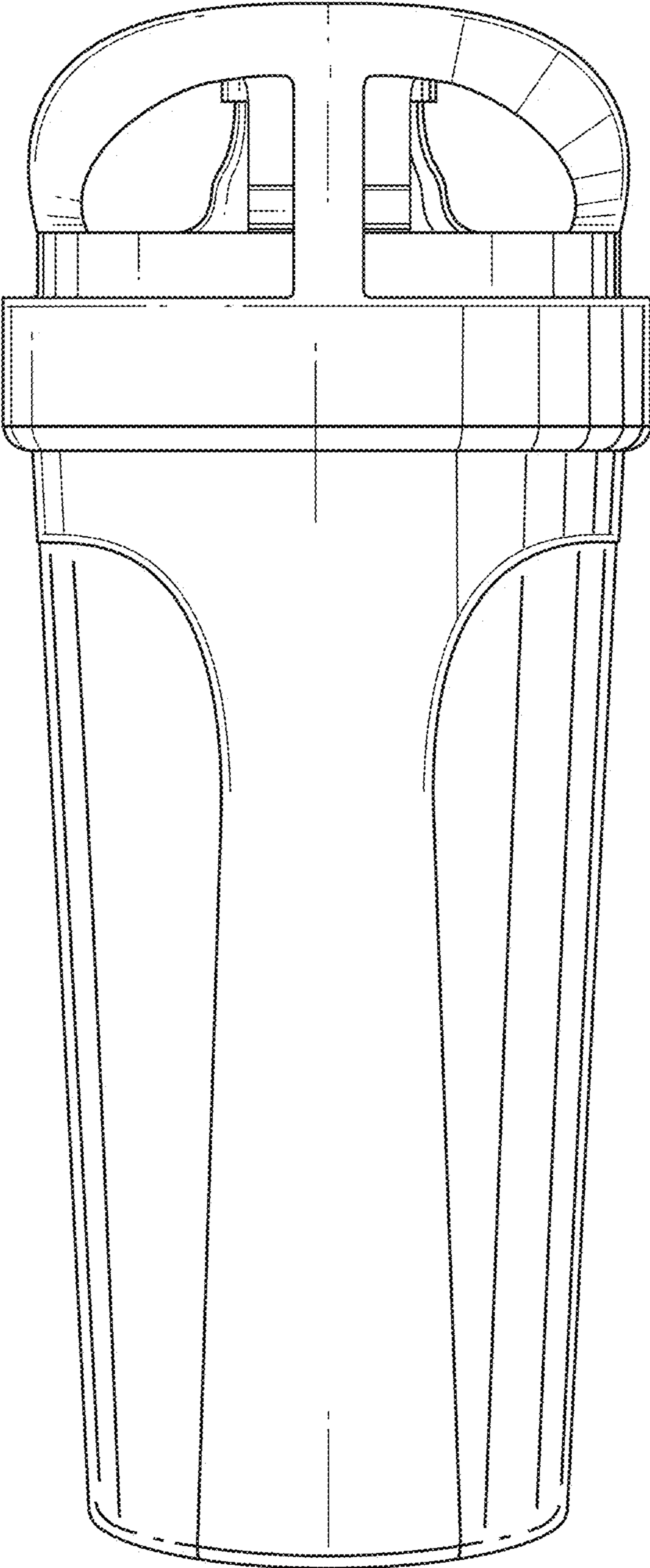

Fig. 5

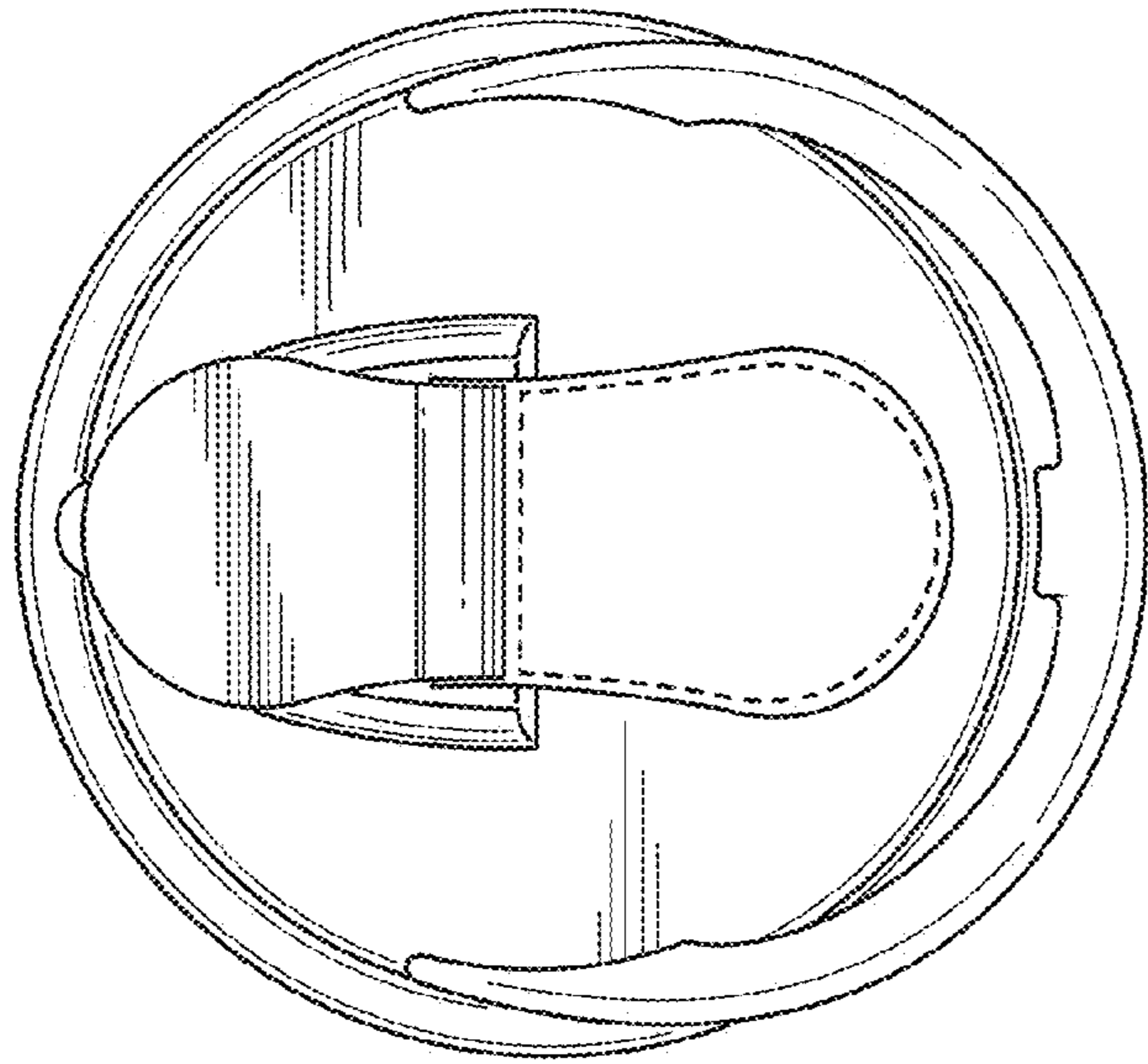

Fig. 6

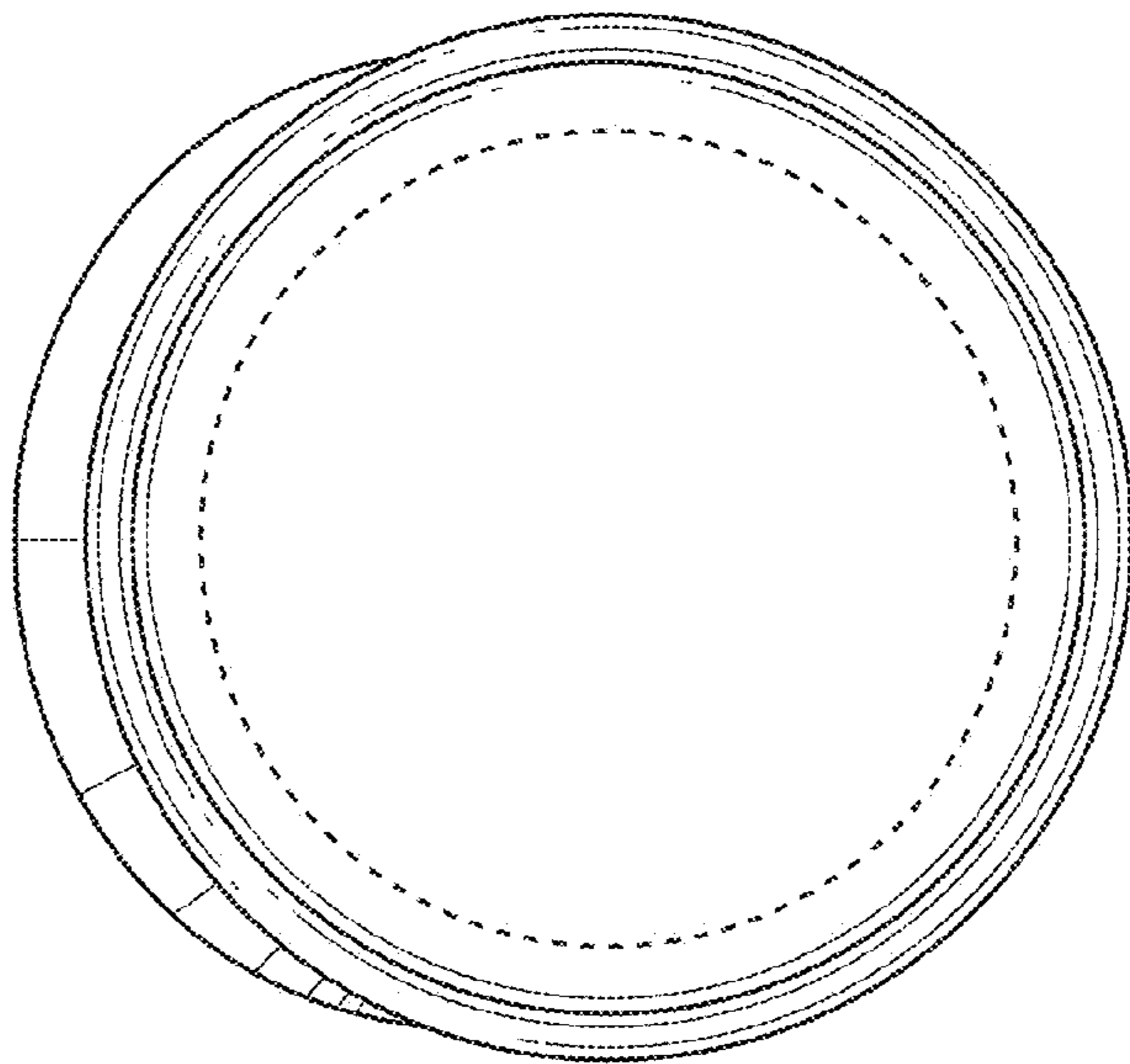

Fig. 7