



US00D723326S

(12) **United States Design Patent**  
**Potter**

(10) **Patent No.:** **US D723,326 S**  
(45) **Date of Patent:** **\*\* Mar. 3, 2015**

(54) **TRIVET WITH SHIFTING PANELS**

(71) Applicant: **Anthony B Potter**, Crozet, VA (US)

(72) Inventor: **Anthony B Potter**, Crozet, VA (US)

(\*\*) Term: **14 Years**

(21) Appl. No.: **29/468,796**

(22) Filed: **Oct. 3, 2013**

(51) **LOC (10) Cl.** ..... **07-99**

(52) **U.S. Cl.**  
USPC ..... **D7/388**; D7/698

(58) **Field of Classification Search**  
CPC ... A47F 5/0018; A47F 5/0031; A47F 5/0093;  
A47F 5/01; A47F 5/0892; F23H 7/04; F23H  
2700/006; F23H 13/02; F23H 7/02; F23H  
1/00; F23H 1/08  
USPC ..... D7/388, 387, 389, 403, 404, 405, 408,  
D7/409, 501, 505, 624, 704, 698, 672,  
D7/624.1, 554.1; D6/3, 4, 405, 522, 520,  
D6/537, 540, 320, 513, 514, 570, 548, 566,  
D6/703.2, 703.3, 707.19, 708, 580, 616;  
248/124.1, 137, 346.01, 346.02,  
248/346.03, 346.06, 346.07, 346.3, 309.2,  
248/150, 678; 297/16.2; 273/261;  
269/289 R, 302.1

See application file for complete search history.

(56) **References Cited**

**U.S. PATENT DOCUMENTS**

3,837,634	A *	9/1974	Cobb	269/289 R
3,947,012	A *	3/1976	Cobb	269/289 R
D257,419	S *	10/1980	Russell	D7/624.1
4,303,246	A *	12/1981	Strongin	273/271
D267,023	S *	11/1982	Bowser	D21/336
D267,386	S *	12/1982	Kneale, III	D7/388
D267,463	S *	1/1983	Thompson	D7/698
D283,777	S *	5/1986	Morin	D7/698
D288,650	S *	3/1987	Mintz	D7/505
D357,847	S *	5/1995	Hoffman	D7/698
D388,278	S *	12/1997	Howitt	D7/388
5,732,947	A *	3/1998	Noack	273/260
5,904,271	A *	5/1999	Collins et al.	222/158

D417,816	S *	12/1999	Kari	D7/388
6,000,666	A *	12/1999	Kari	248/150
6,260,847	B1 *	7/2001	Lueder	273/261
6,412,778	B1 *	7/2002	Alaimo	273/261
D472,776	S *	4/2003	Porter	D7/698
D534,011	S *	12/2006	Stevens	D6/449
D538,860	S *	3/2007	Benoit	D21/336
D589,387	S *	3/2009	Brown	D10/91
D609,538	S *	2/2010	Sullivan	D7/698
8,240,347	B2 *	8/2012	Ishida	144/144.1
8,286,956	B2 *	10/2012	Pearl et al.	269/289 R
D675,071	S *	1/2013	Kramer	D7/698
D677,130	S *	3/2013	Robinson	D7/698
D689,349	S *	9/2013	Grandone	D7/698
D702,096	S *	4/2014	Stineburg	D7/698
D715,097	S *	10/2014	Thonis et al.	D7/388
2007/0034755	A1 *	2/2007	Duke	248/127
2008/0301965	A1 *	12/2008	Taylor	33/566
2014/0183319	A1 *	7/2014	Tubbs	248/346.02

**OTHER PUBLICATIONS**

<http://lumberjocks.com/projects/34378> Illusion Cutting Board by Lumberjacks.com on Jan. 18, 2013.\* <http://www.novica.com/itemdetail/index.cfm?pid=189935> Teakwood trivet, Eco Puzzle by NOVICA on Nov. 15, 2012.\*

\* cited by examiner

*Primary Examiner* — Marianne Pandozzi

*Assistant Examiner* — Jae Liang

(57) **CLAIM**

The ornamental design for a trivet with shifting panels, as shown and described.

**DESCRIPTION**

FIG. 1 is a top, front, right side perspective view of a first embodiment of my new trivet with shifting panels in its closed position;  
FIG. 2 is a top plan view thereof;  
FIG. 3 is a front elevational view thereof, the back being a mirror image;  
FIG. 4 is a right side elevational view thereof, the left side being the same;  
FIG. 5 is a bottom plan view thereof;  
FIG. 6 is bottom, back, right side perspective view thereof;

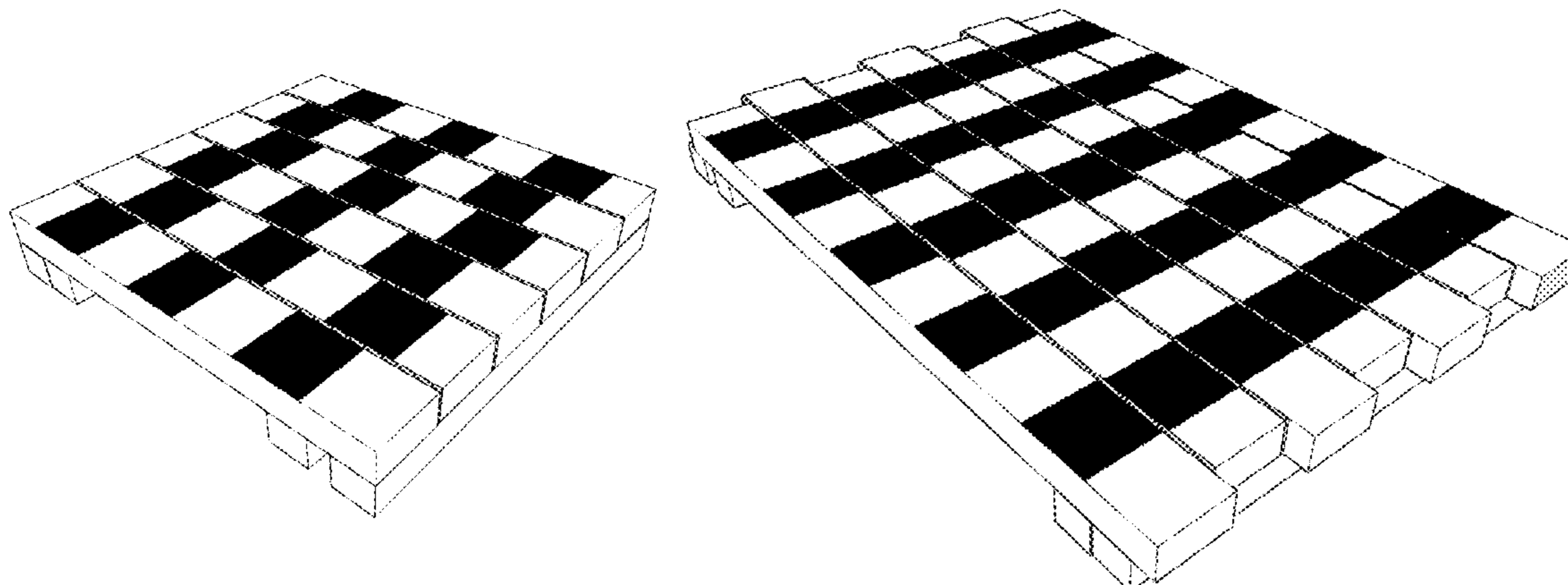

FIG. 7 is a top, front, right side perspective view of the first embodiment of my trivet with shifting panels in its expanded position;

FIG. 8 is a top plan view thereof;

FIG. 9 is a front elevational view thereof;

FIG. 10 is a back elevational view thereof;

FIG. 11 is a right side elevational view thereof, the left side being the same;

FIG. 12 is a bottom plan view thereof;

FIG. 13 is a bottom, back, right side perspective view thereof;

FIG. 14 is a top, front, right side perspective view of a second embodiment of my trivet with shifting panels in its closed position, the dark squares in each row of which are inlaid to depth visible on the front and back of the trivet, the top, left side, right side, and bottom views of which are the same as FIGS. 2, 4 and 5;

FIG. 15 is a front elevational view thereof;

FIG. 16 is a back elevational view thereof;

FIG. 17 is a front elevational view of the second embodiment of my trivet with shifting panels in its expanded position, the top, right side, left side and bottom views of which are the same as FIGS. 8, 11, and 12;

FIG. 18 is a back elevational view thereof;

FIG. 19 is a top, front, right side perspective view of a third embodiment of my trivet with shifting panels lacking the four pediment components in its closed position the top plan view of which is the same as FIG. 2.

FIG. 20 is a front elevational view thereof, the back being the same;

FIG. 21 is a right side elevational view thereof, the left side being the same;

FIG. 22 is a bottom plan view thereof;

FIG. 23 is a top, front, right side perspective view of the third embodiment of my trivet with shifting panels in its expanded position, the right and left side elevational views of which are the same as FIG. 21;

FIG. 24 is a top plan view thereof;

FIG. 25 is a front elevational view thereof;

FIG. 26 is a back elevational view thereof; and

FIG. 27 is a bottom plan view thereof;

FIG. 28 is a top, front, right side perspective view of a fourth embodiment of my trivet with shifting panels in its closed position the top pattern of which has 7 rows instead of 6 and with each row comprising 11 rectilinear shapes instead of 7, the front, back, left side, right side and bottom views of which are the same as those in FIGS. 3-5 except for the length and width of the central portions;

FIG. 29 is a top plan view thereof;

FIG. 30 is a top, front, right side perspective of the fourth embodiment of my trivet with shifting panels in its expanded position, the front, back, left side, right side and bottom views of which are the same as those in FIGS. 9-12 except for the length and width of the central portions;

FIG. 31 is a top plan view thereof;

FIG. 32 is a top, front right side perspective view of a fifth embodiment of a trivet with shifting panels in its closed position; and,

FIG. 33 is a top, front right side perspective view of a fifth embodiment of a trivet with shifting panels in its expanded position.

The broken away symbols in the drawings indicate the appearance of any portion of the article between the break lines forms no part of the claimed design.

**1 Claim, 12 Drawing Sheets**

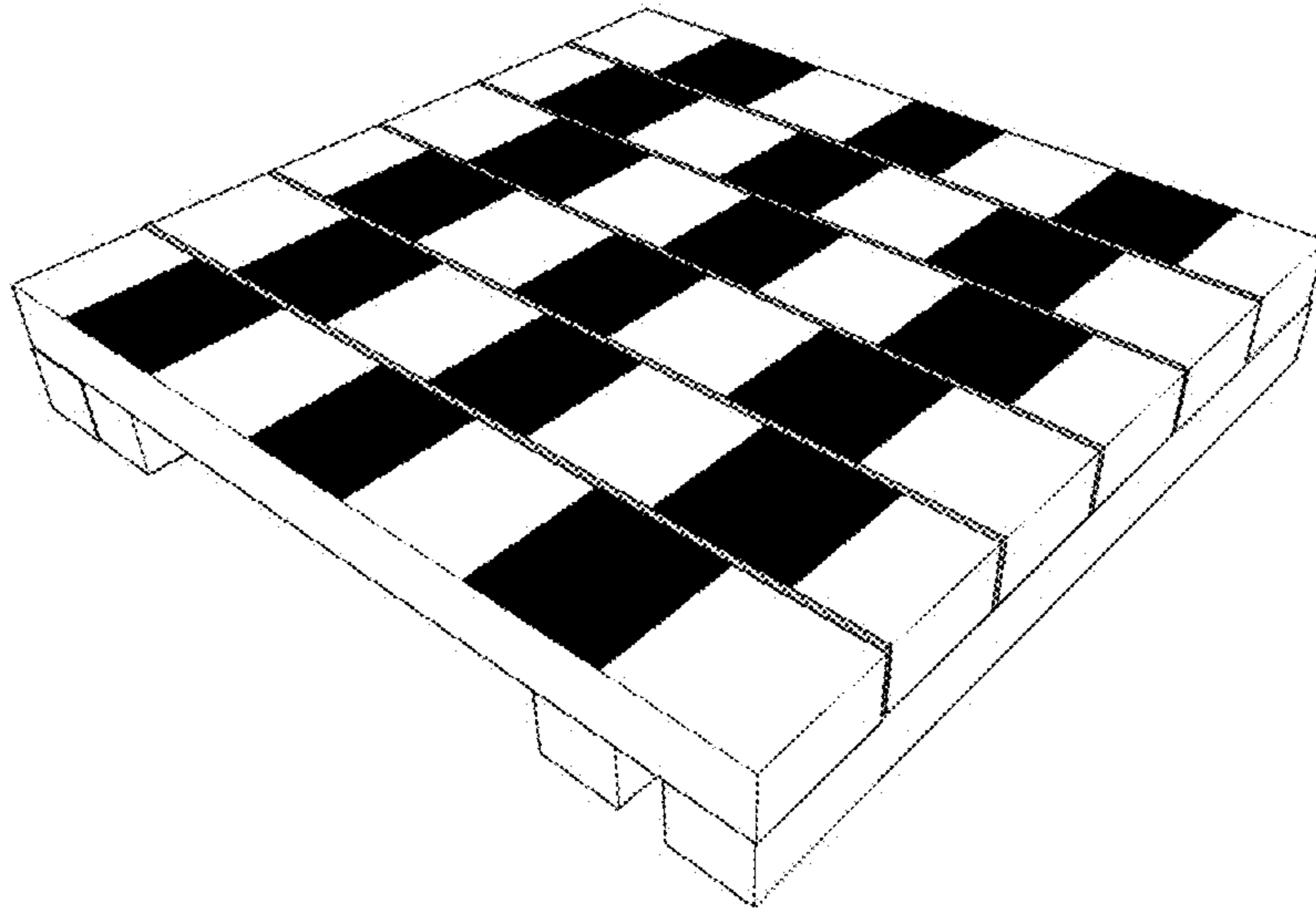

Fig. 1

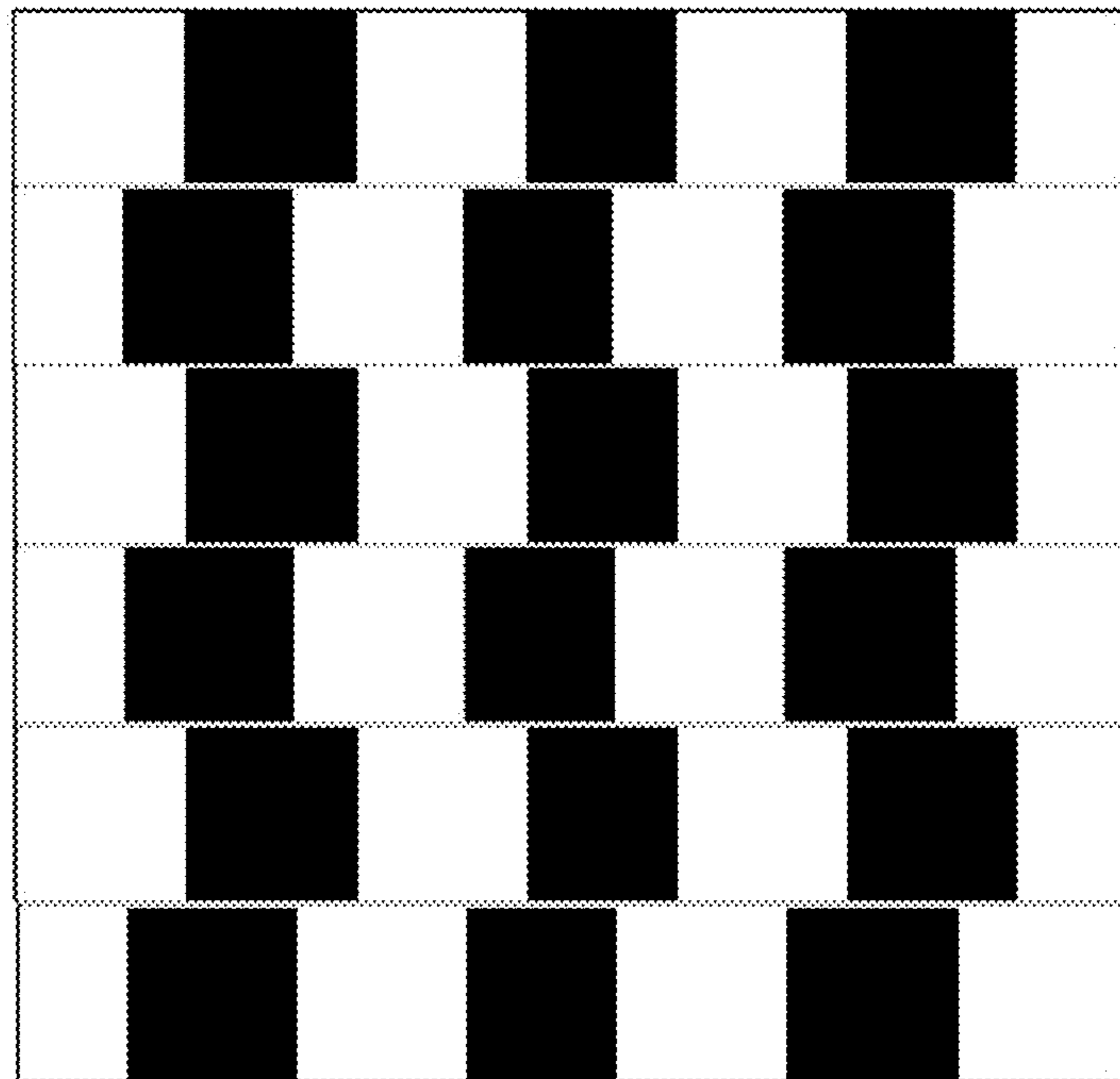

Fig. 2

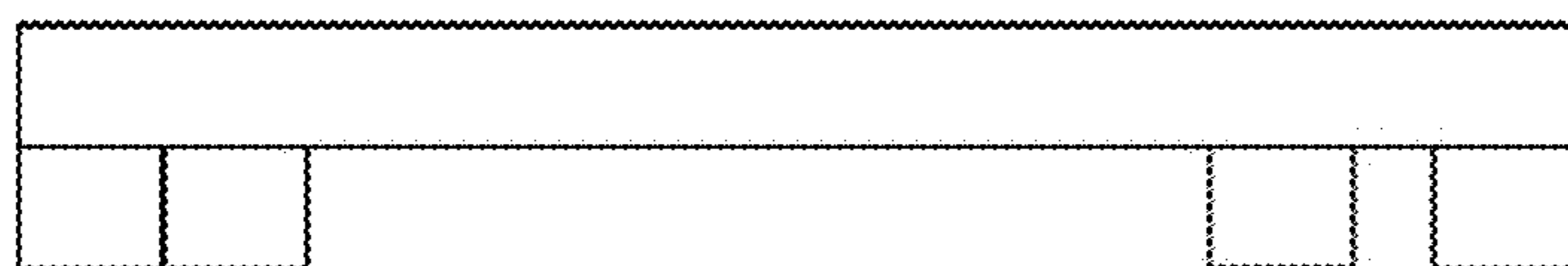

Fig. 3

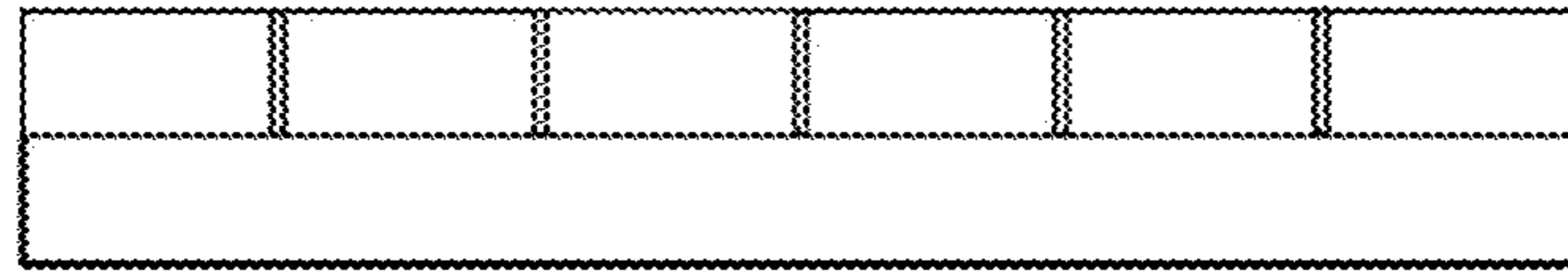

Fig. 4

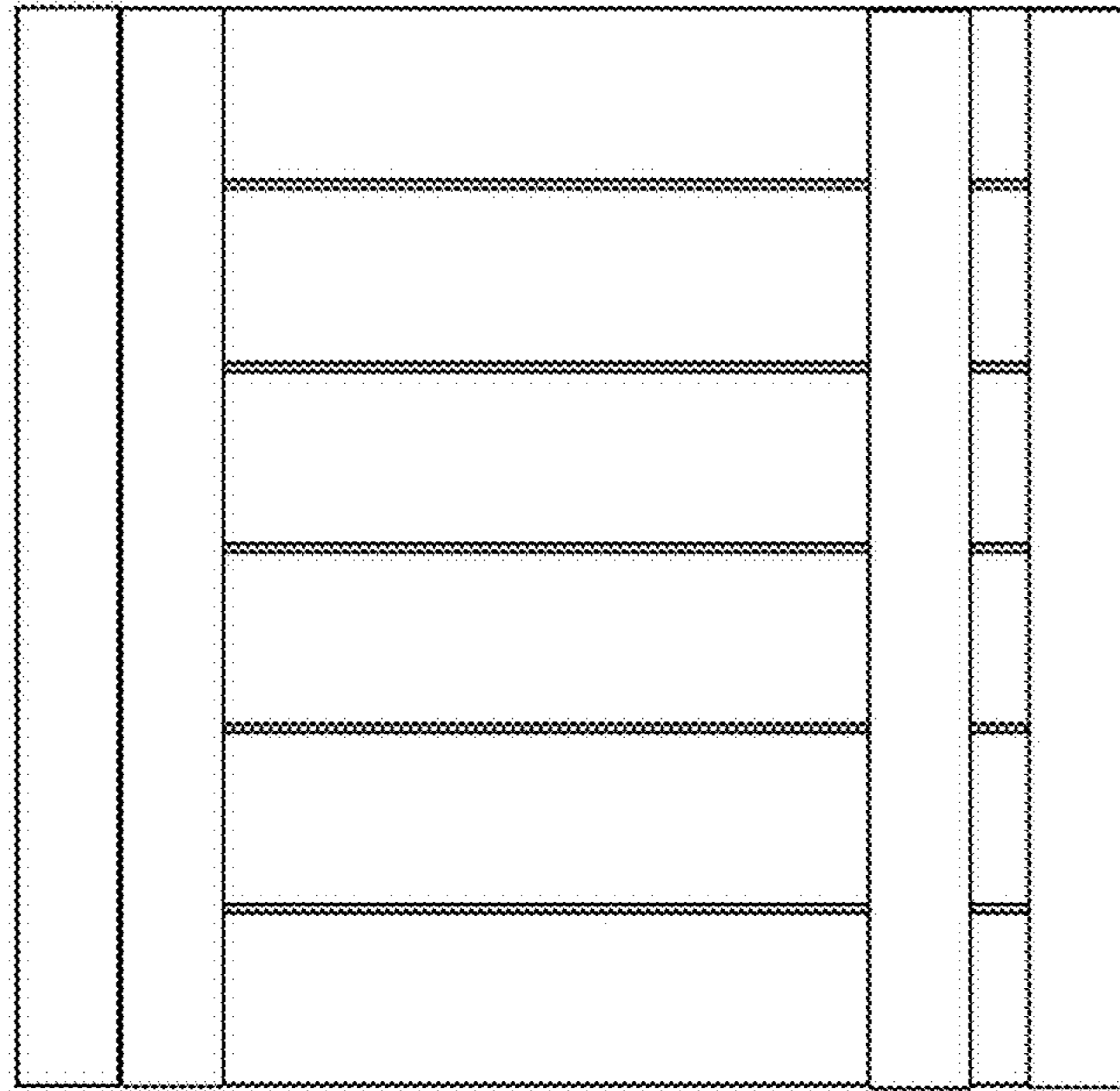

Fig. 5

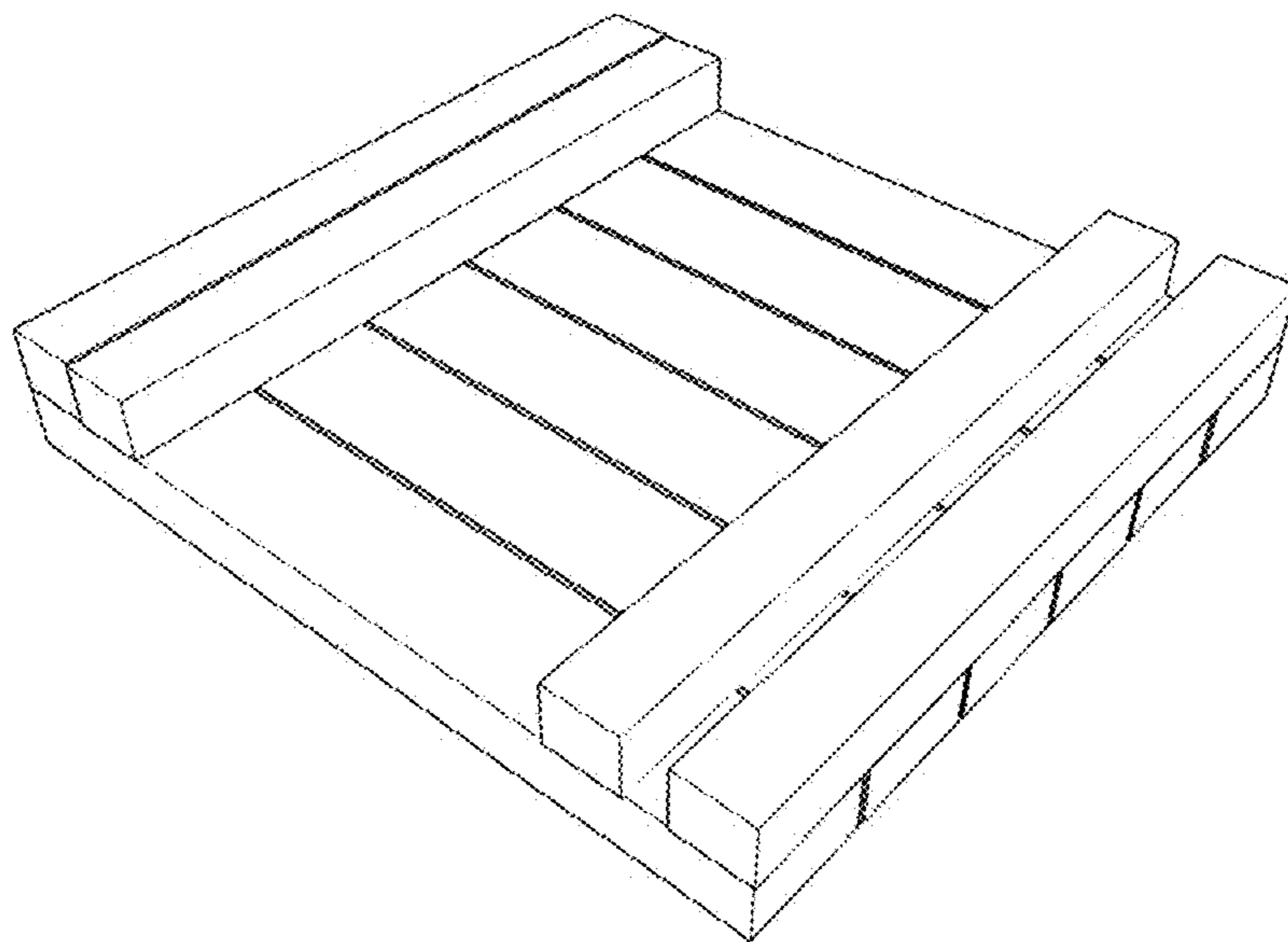

Fig. 6

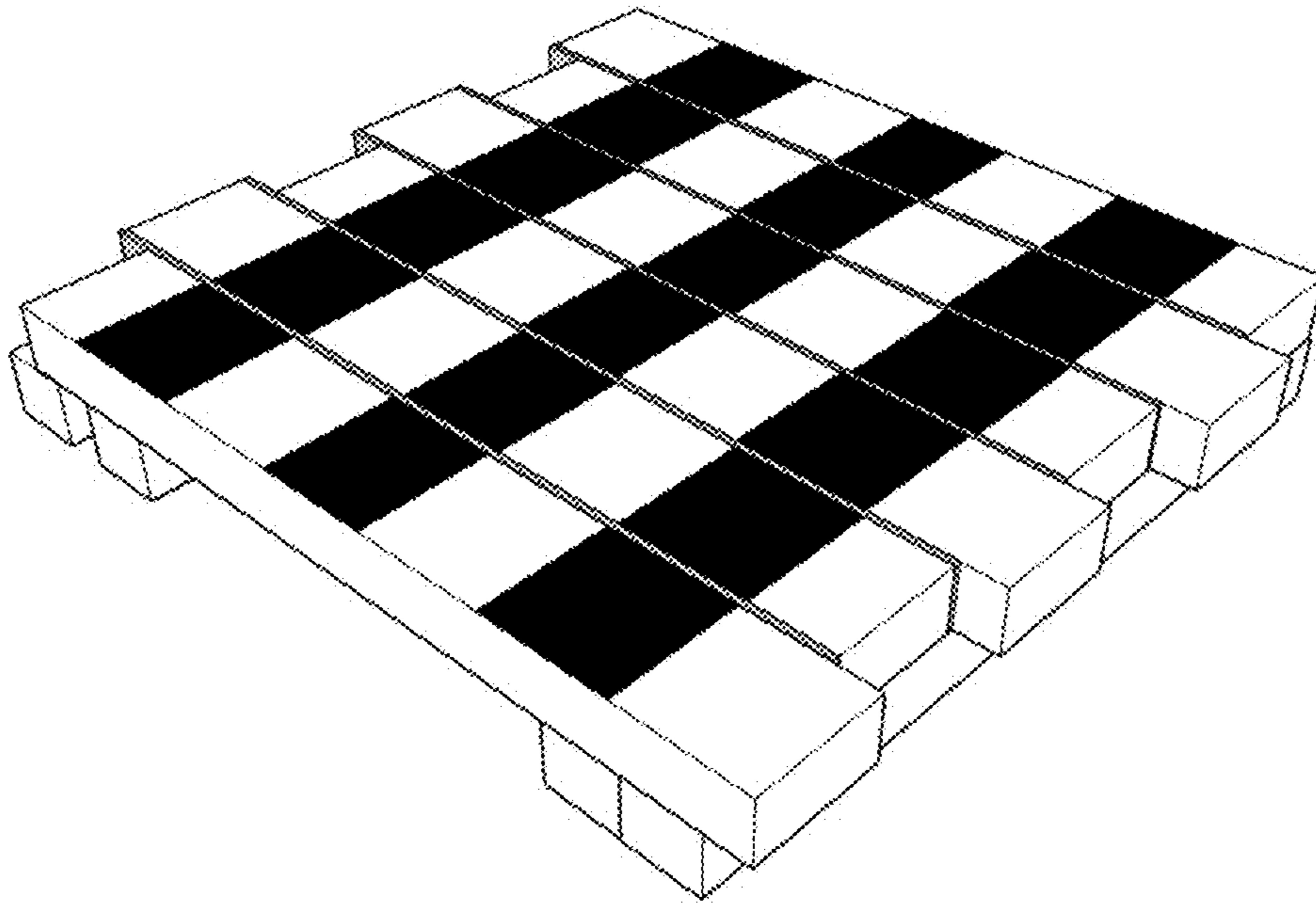

Fig. 7

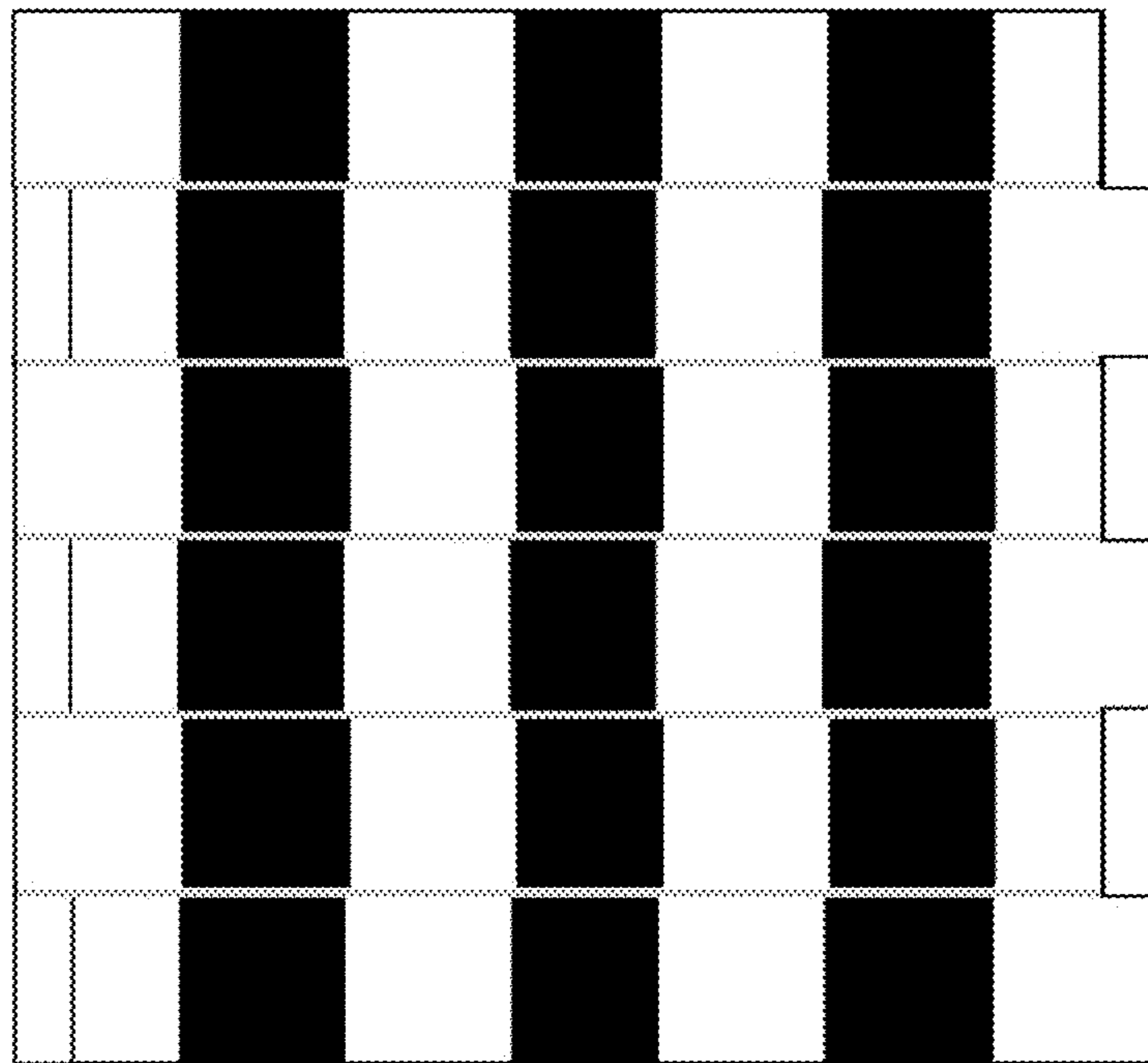

Fig. 8



Fig. 9



Fig. 10

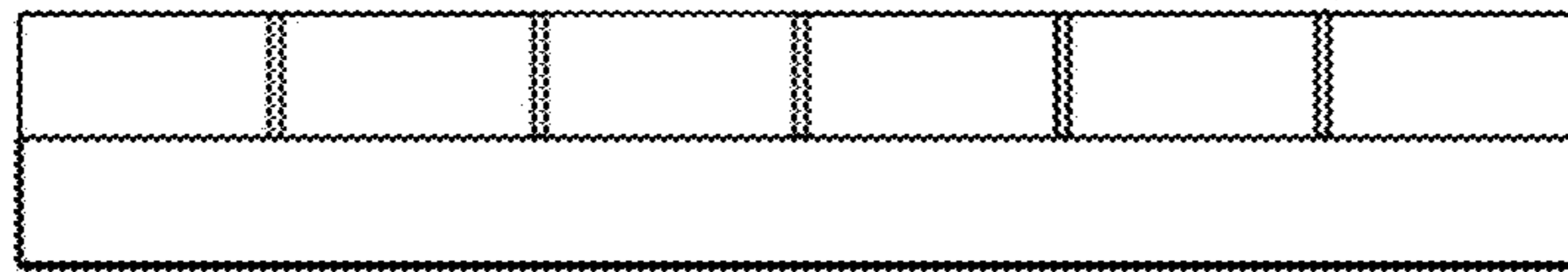

Fig. 11

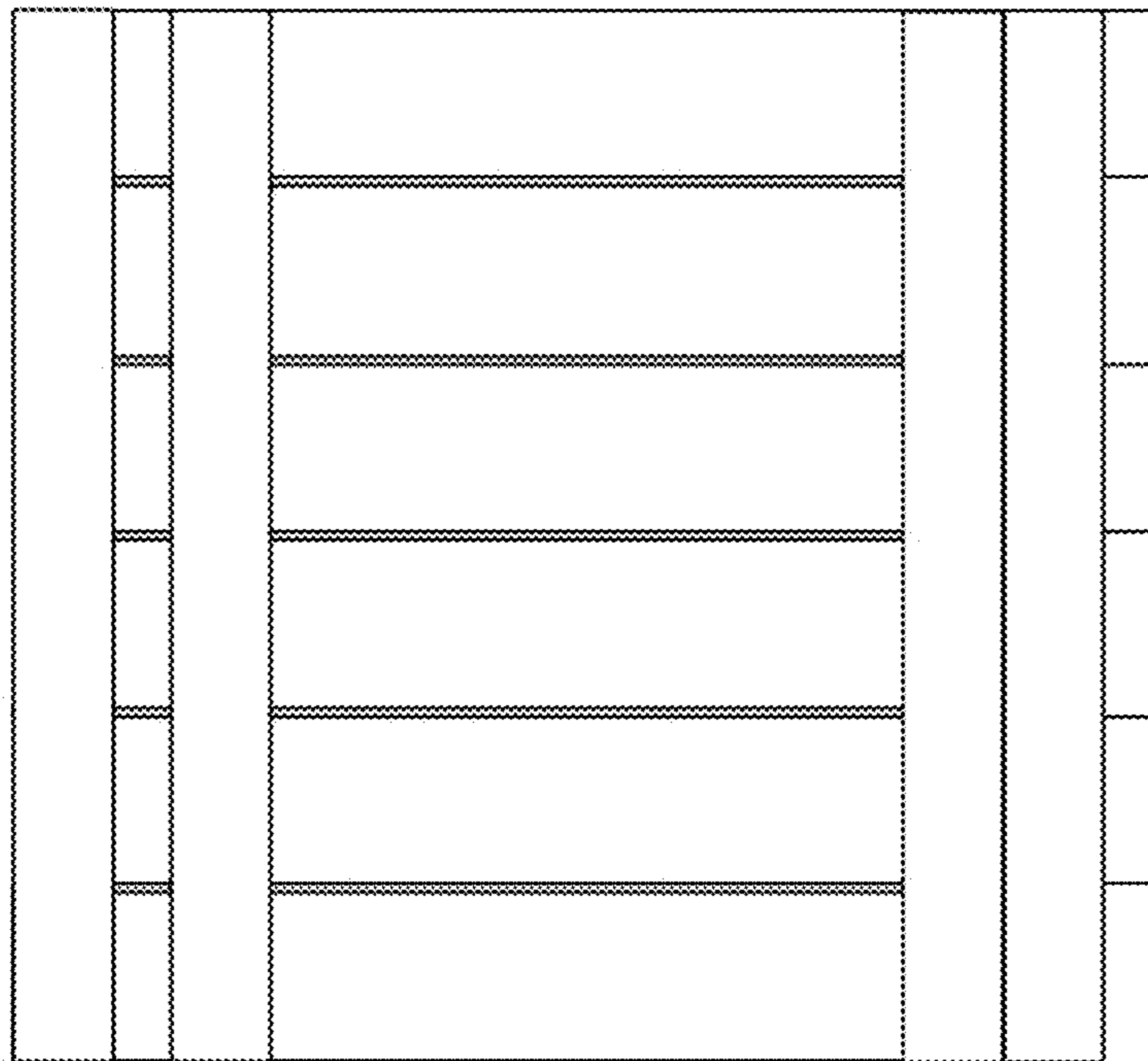

Fig. 12

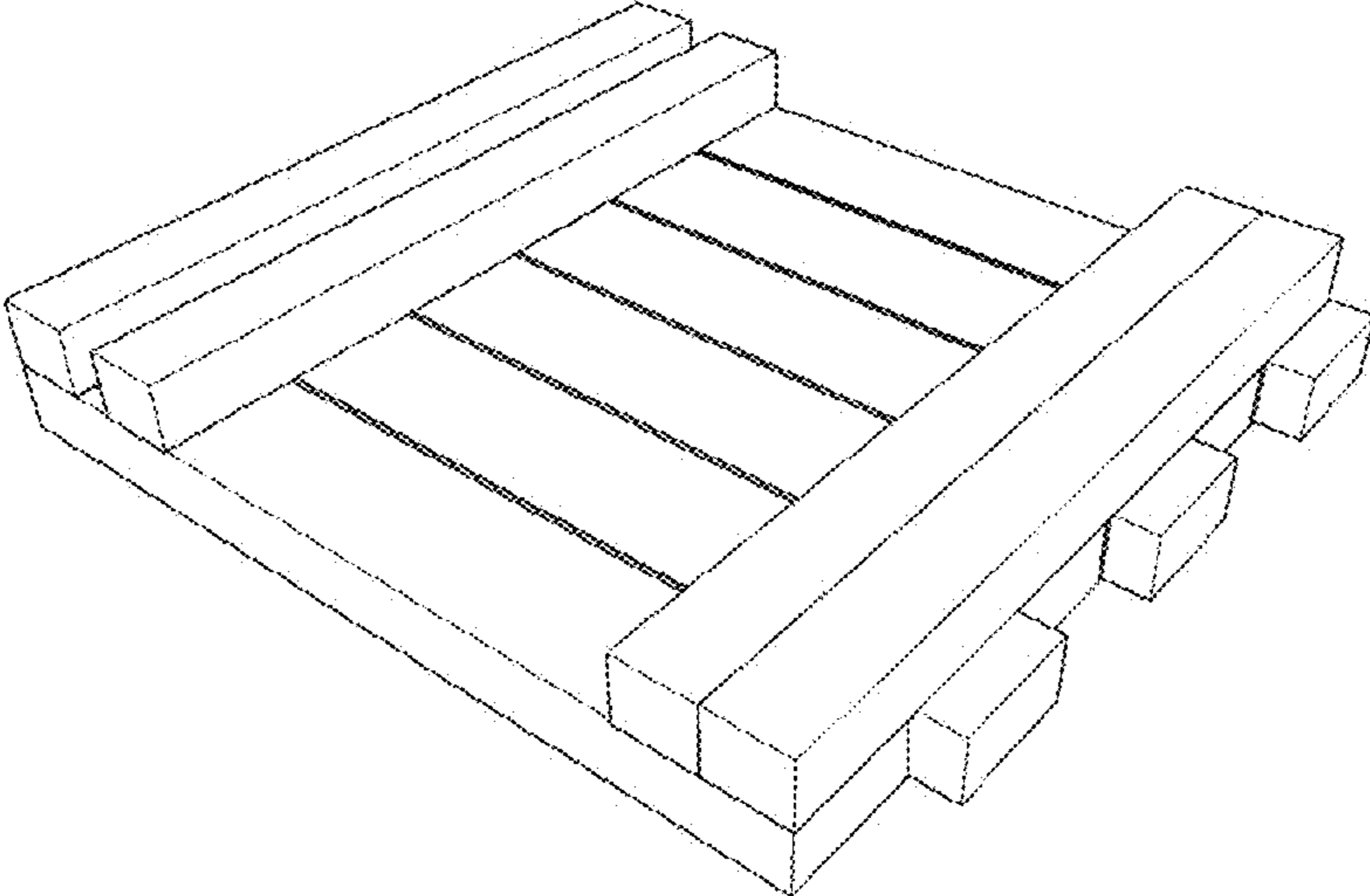

Fig. 13

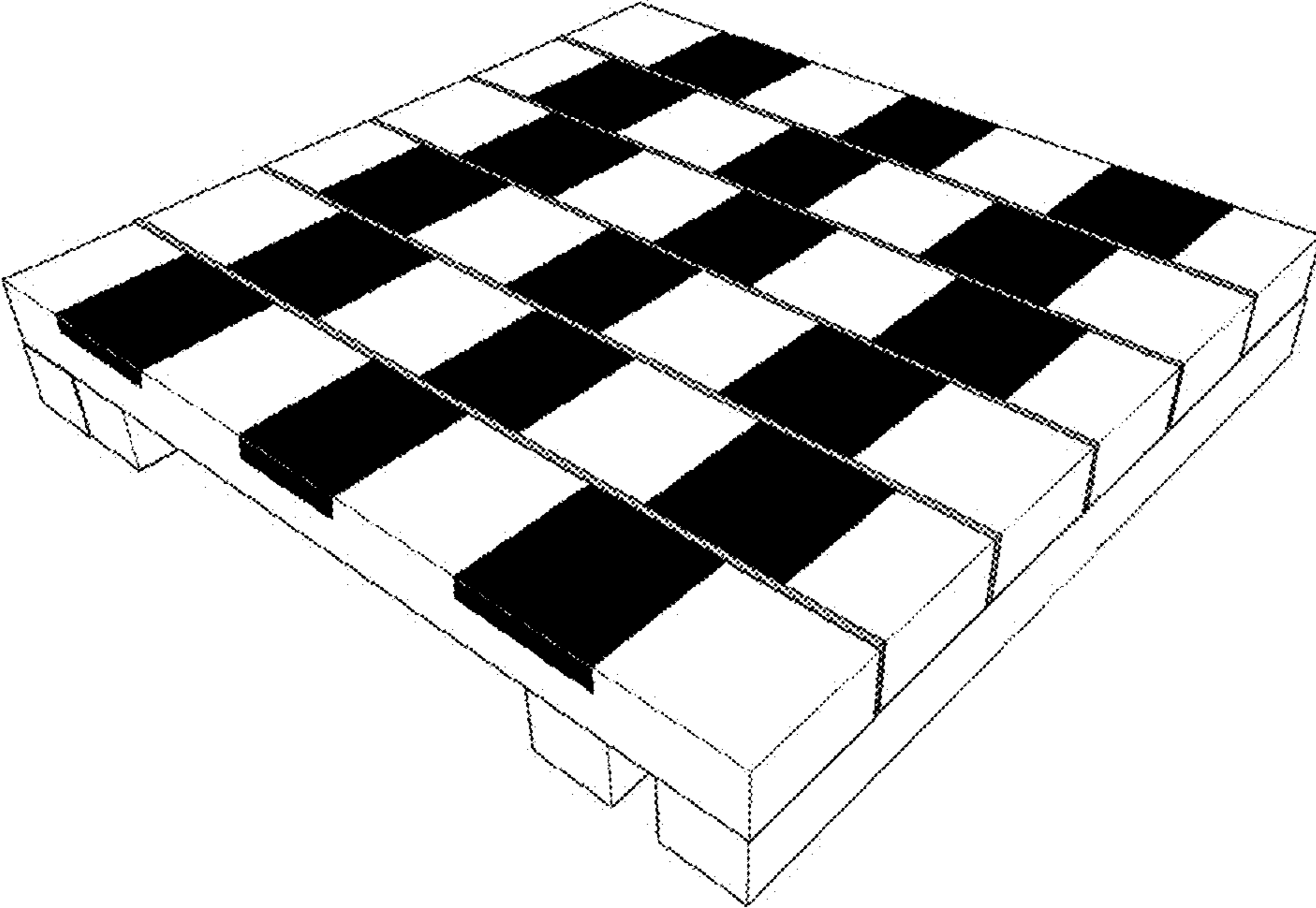

Fig. 14



Fig. 15



Fig. 16



Fig. 17



Fig. 18

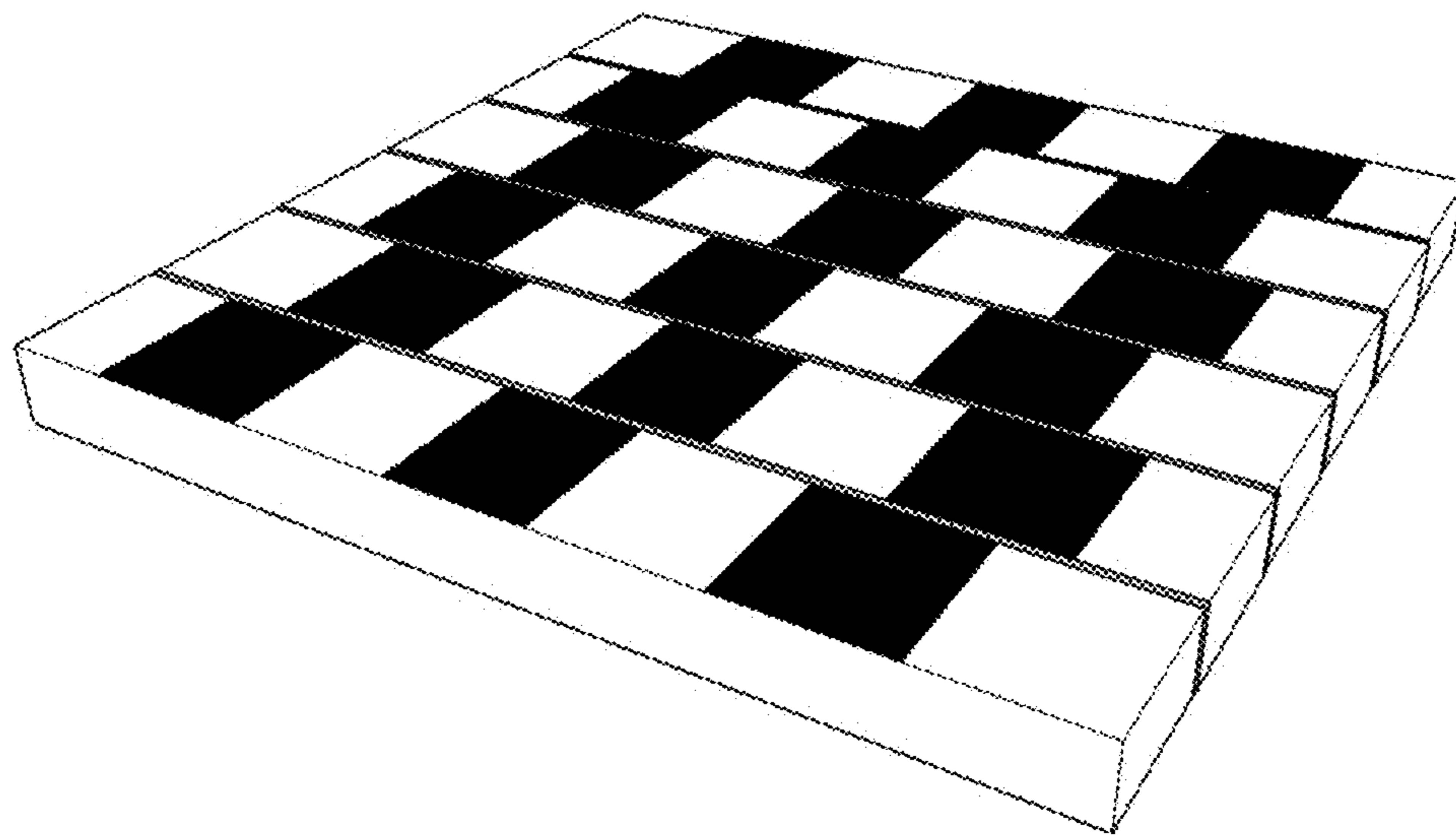

Fig. 19

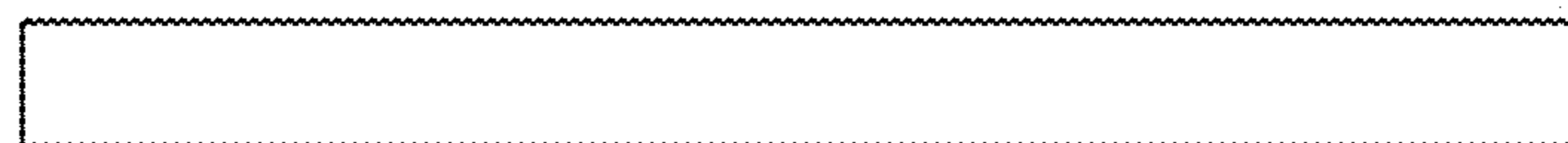

Fig. 20



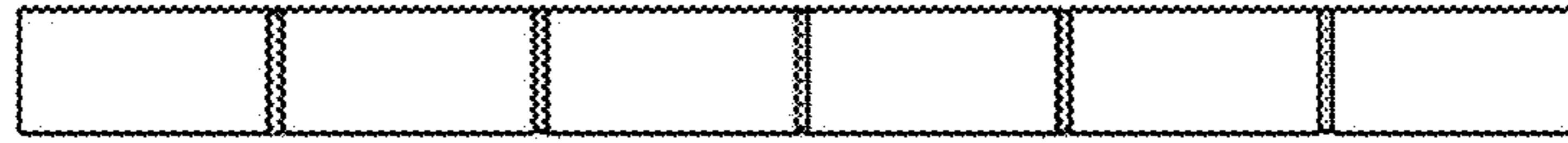

Fig. 21

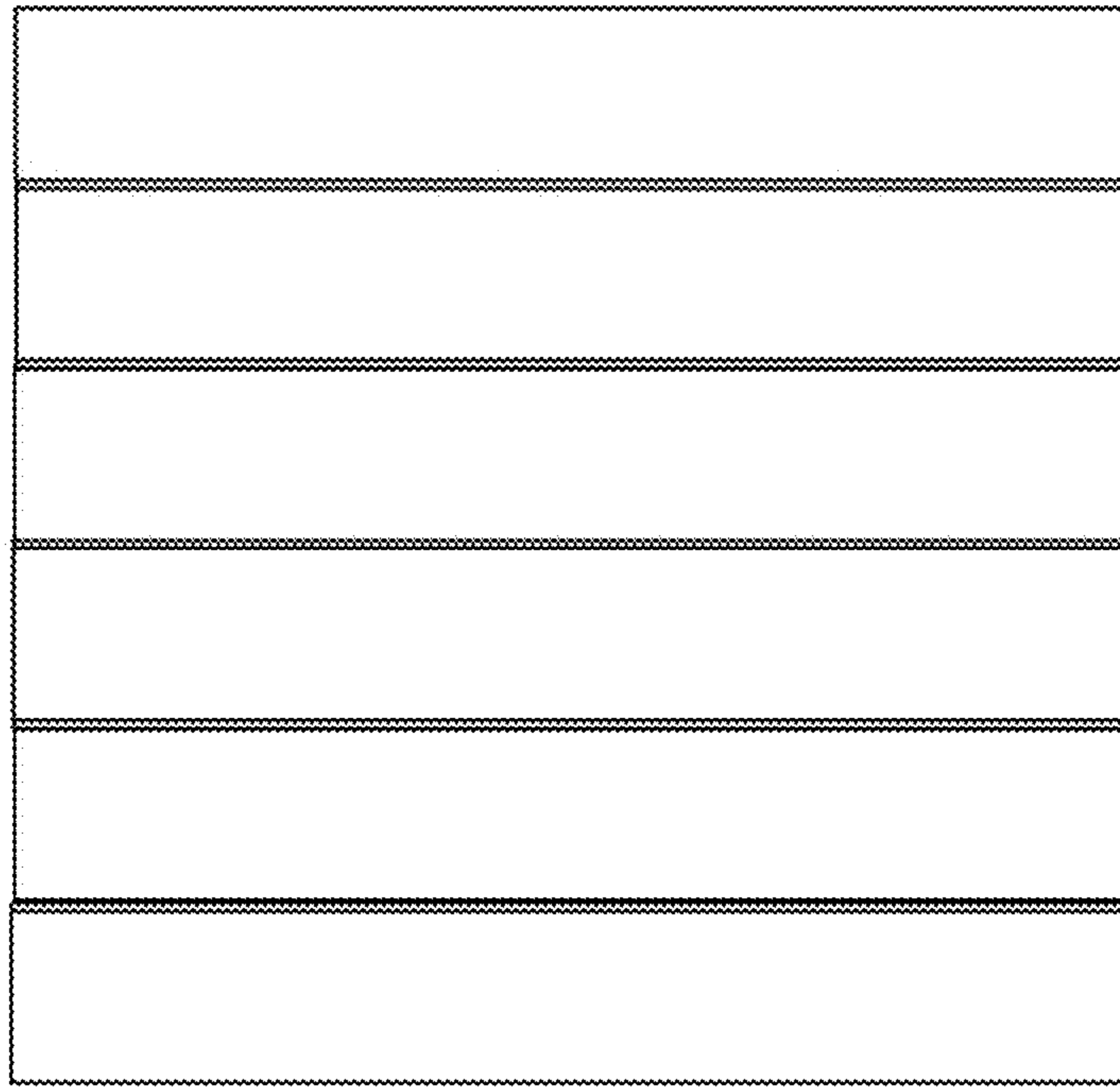

Fig. 22

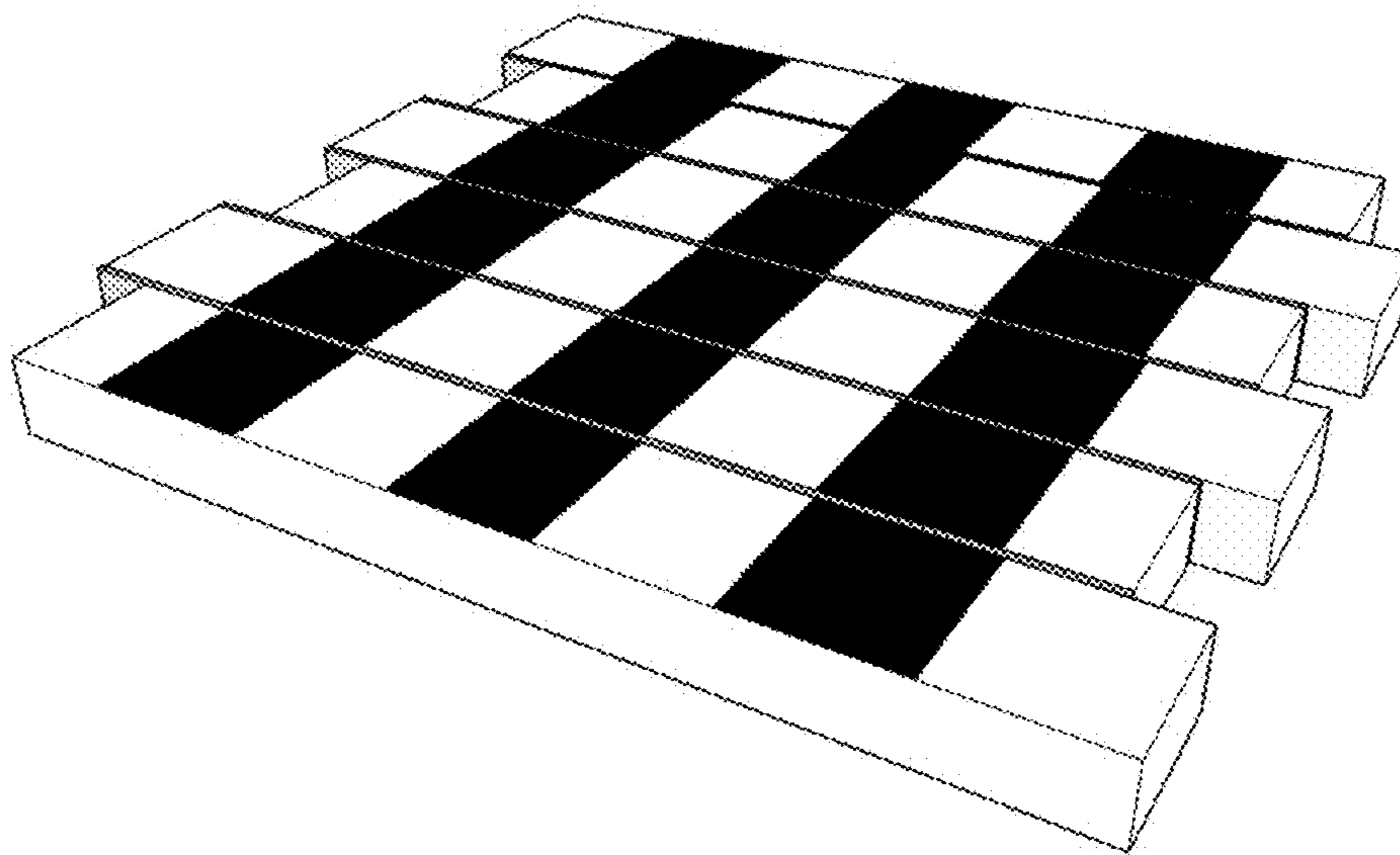

Fig. 23

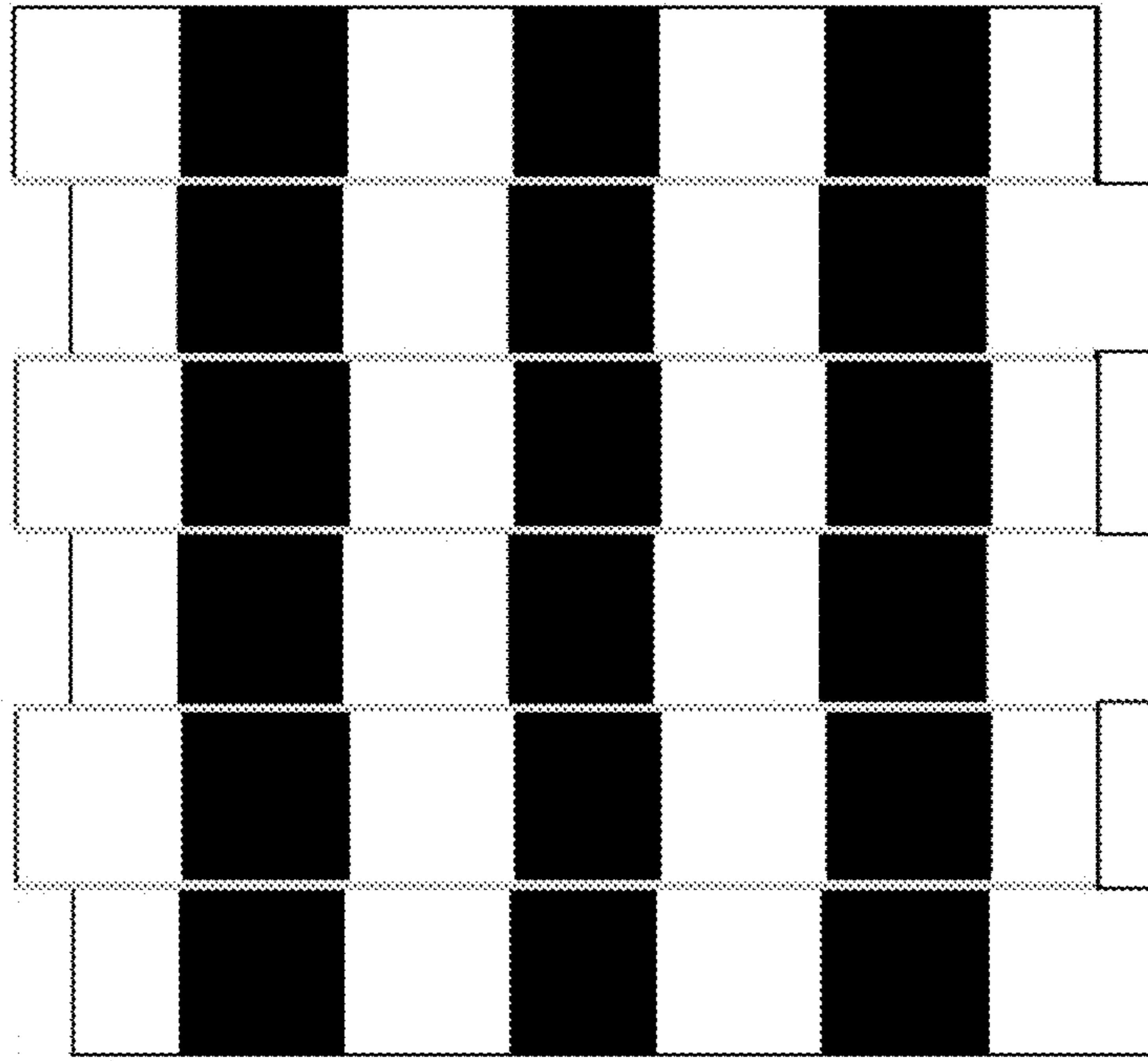

Fig. 24



Fig. 25



Fig. 26

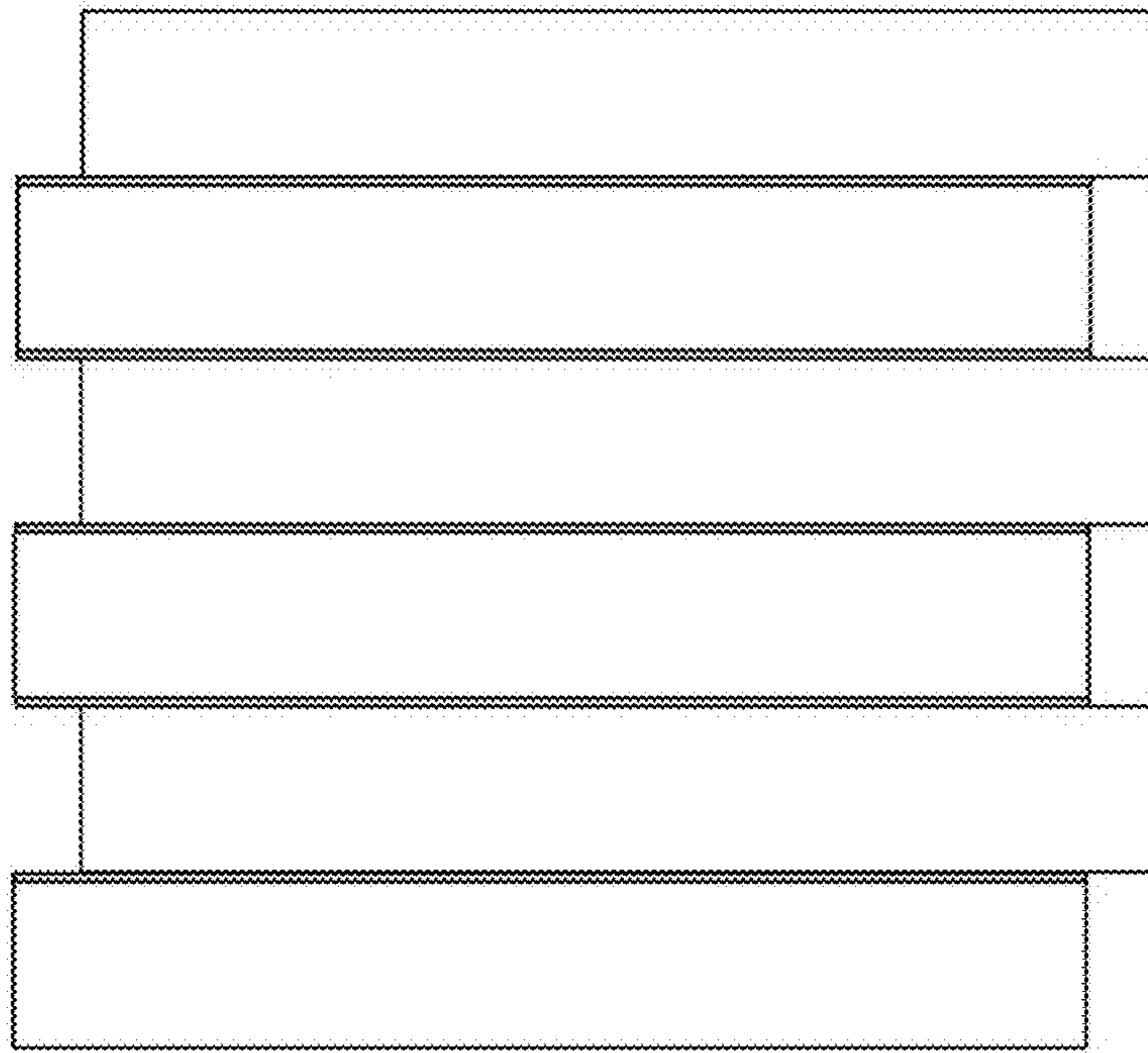

Fig. 27

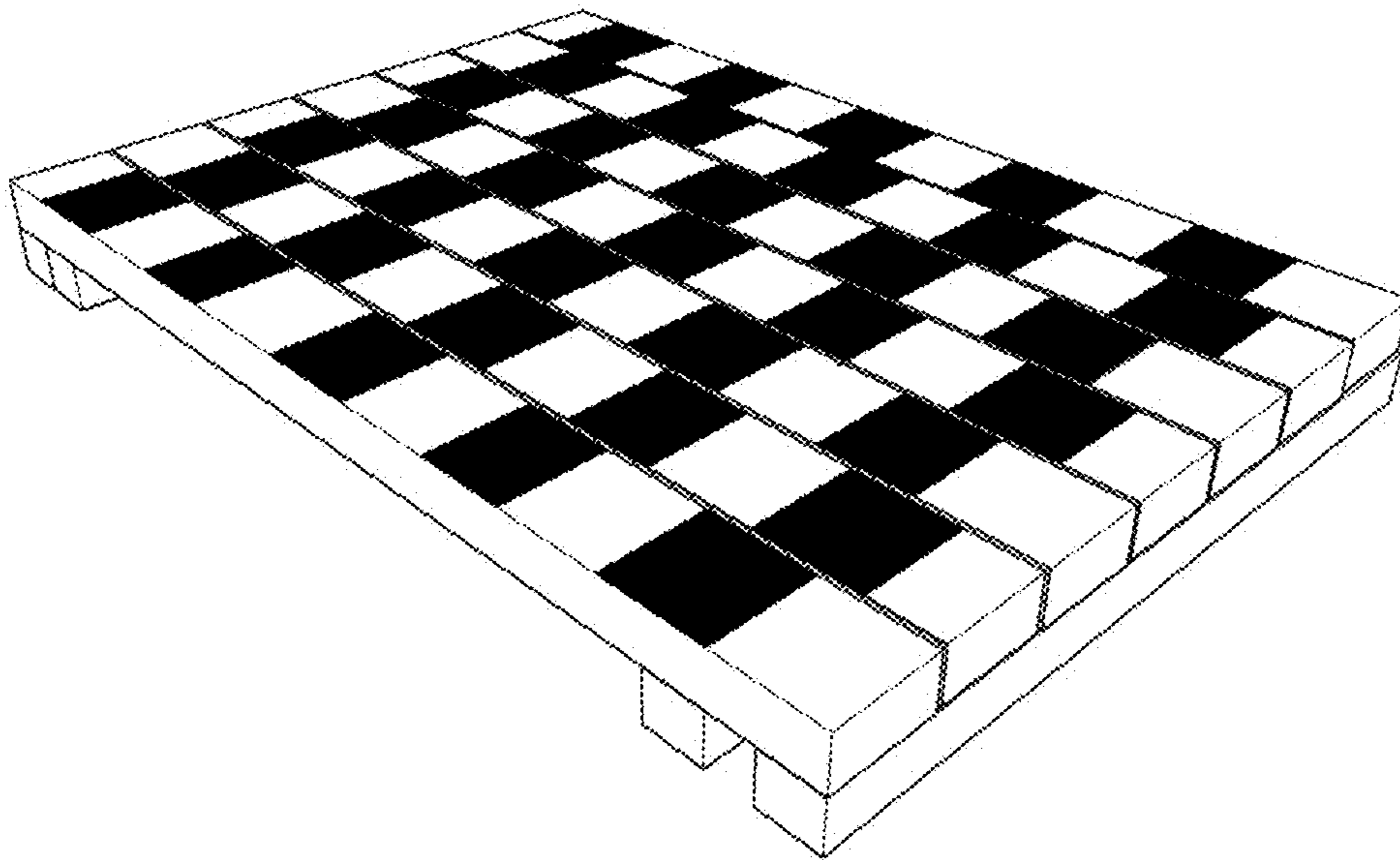

Fig. 28

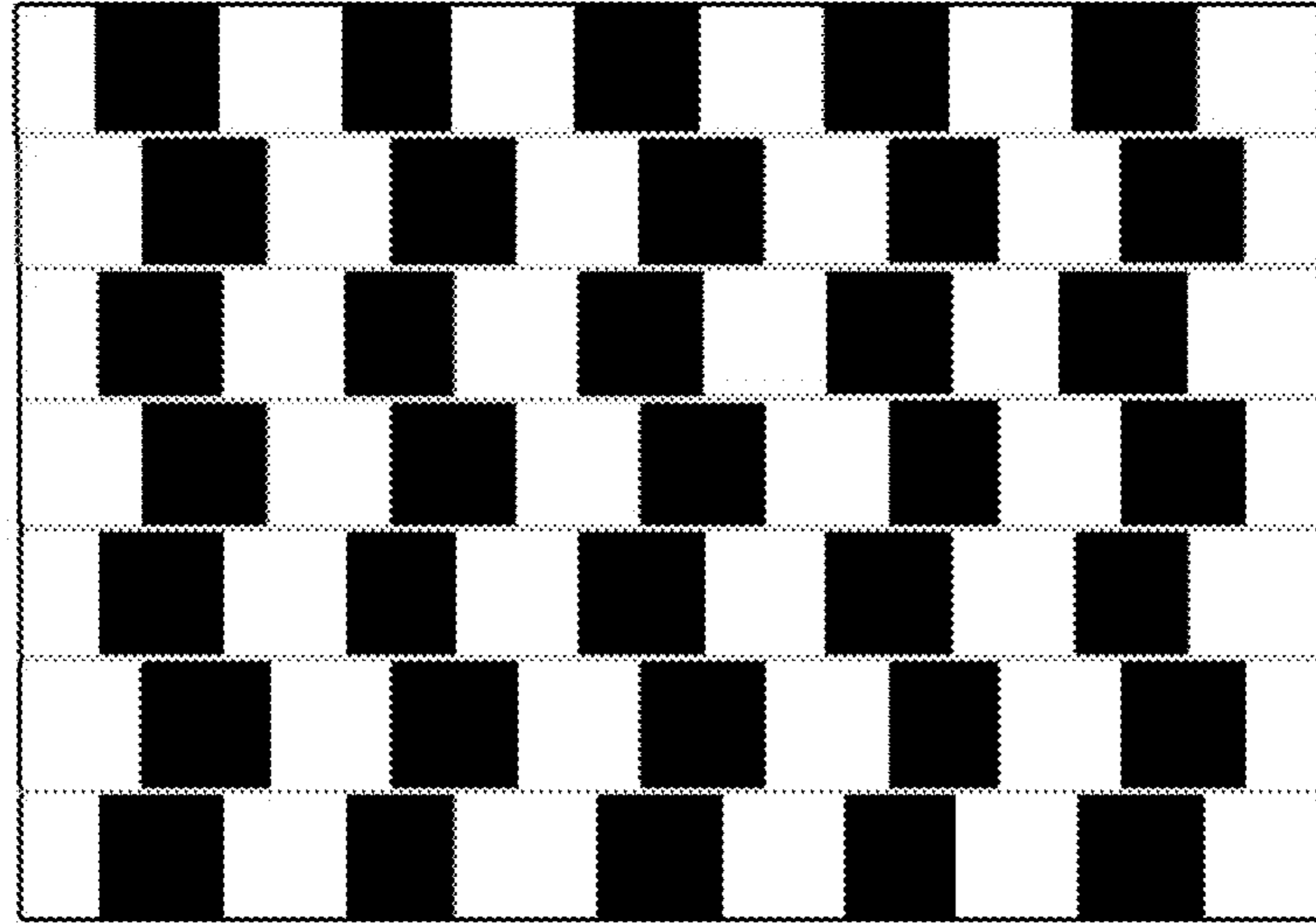

Fig. 29

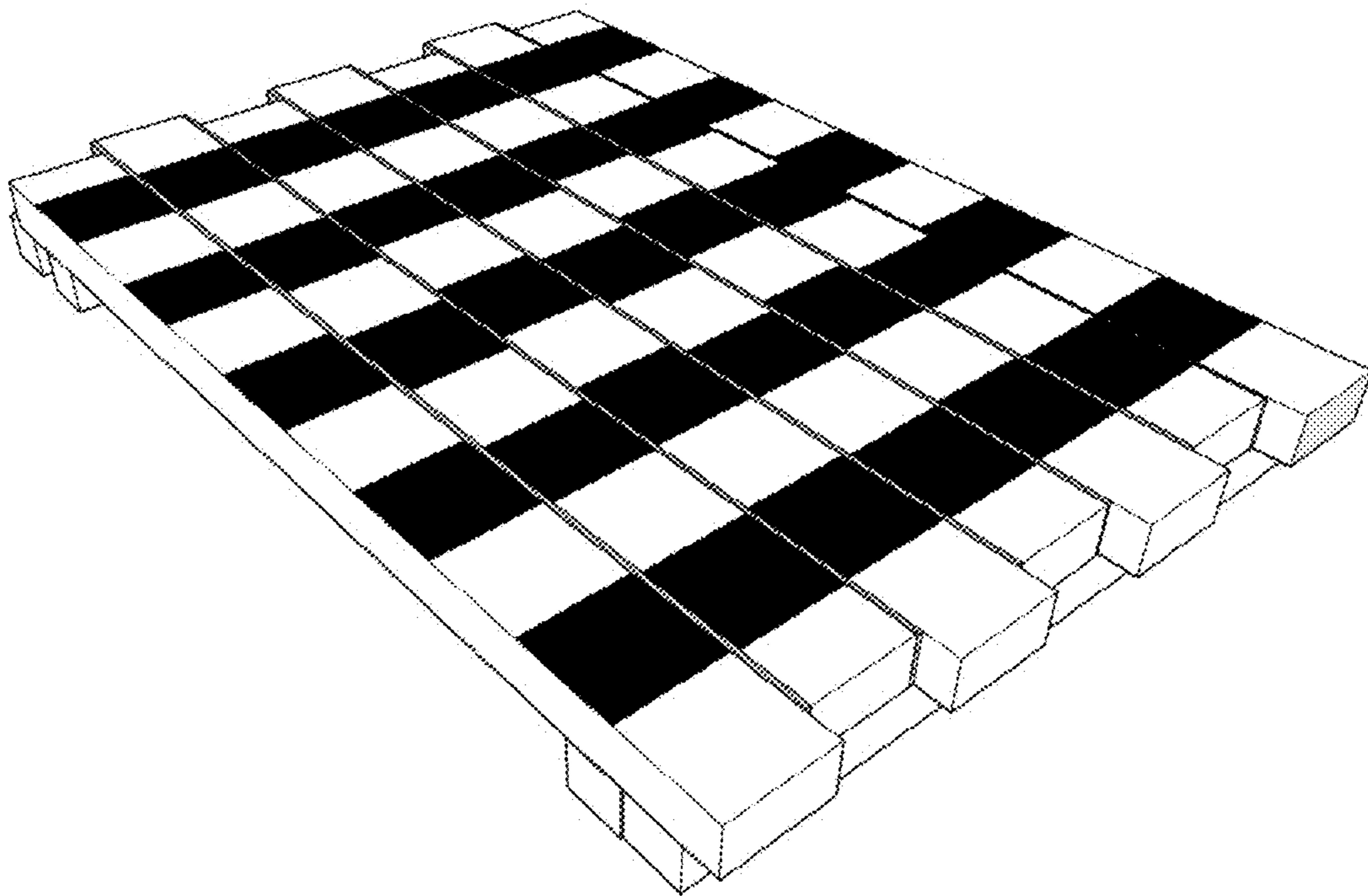

Fig. 30

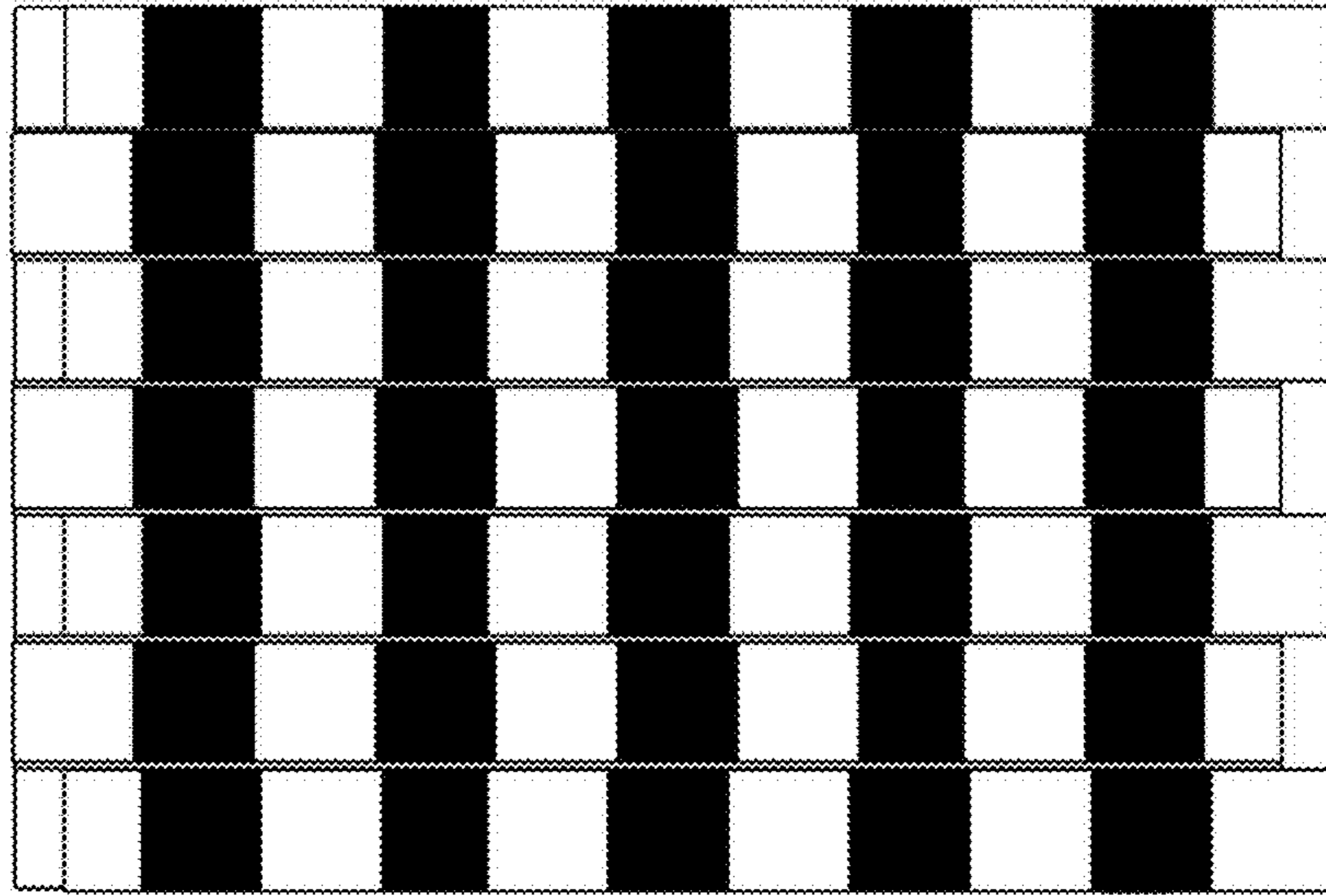

Fig. 31

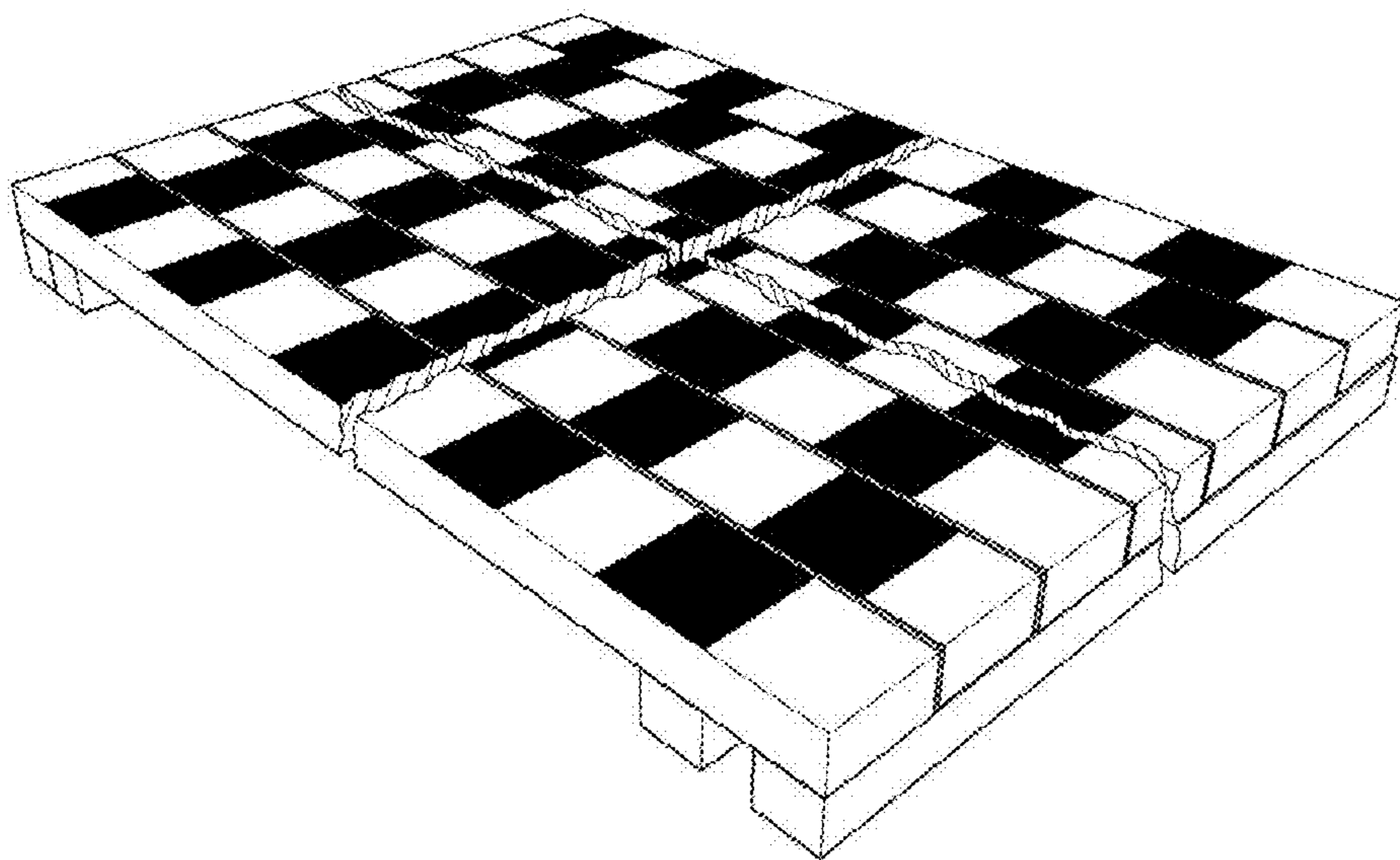

Fig. 32

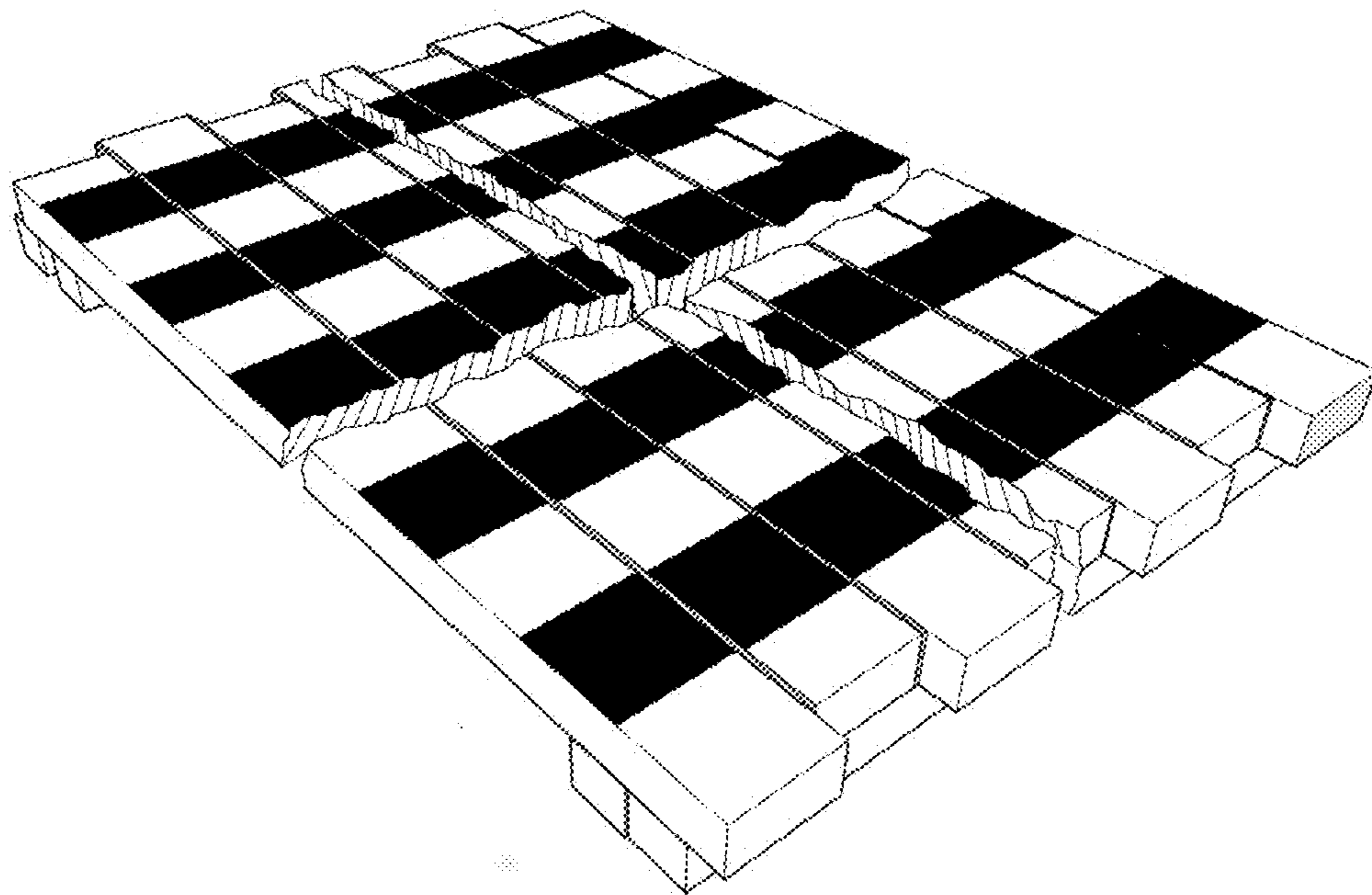

Fig. 33