



US00D723308S

(12) **United States Design Patent**  
**Franck et al.**

(10) **Patent No.:** **US D723,308 S**  
(45) **Date of Patent:** **\*\* Mar. 3, 2015**

(54) **EXTENDABLE AND VERSATILE RACK**

(71) Applicant: **WirePath Home Systems, LLC**,  
Charlotte, NC (US)

(72) Inventors: **Christopher Glenn Franck**, Fort Mill,  
SC (US); **William Jacob Kozlowski, Jr.**,  
Waxhaw, NC (US); **Jamie Lee Quinlan**,  
Charlotte, NC (US)

(73) Assignee: **WirePath Home Systems, LLC**,  
Charlotte, NC (US)

(\*\*) Term: **14 Years**

(21) Appl. No.: **29/498,845**

(22) Filed: **Aug. 8, 2014**

(51) **LOC (10) Cl.** ..... **06-06**

(52) **U.S. Cl.**  
USPC ..... **D6/675**

(58) **Field of Classification Search**  
USPC ..... D6/396, 449, 467, 474, 477-479, 480,  
D6/485, 503, 382-384; D14/447, 451,  
D14/501; D3/297; 211/26, 134, 194;  
108/43, 57.16, 57.17, 57.18, 57.21;  
248/188.1, 188.2, 188.4, 456

See application file for complete search history.

(56) **References Cited**

**U.S. PATENT DOCUMENTS**

D158,876 S *	6/1950	Lowell	.....	D34/18
D326,198 S *	5/1992	Pacetti et al.	.....	D6/477
D362,102 S *	9/1995	Campbell et al.	.....	D34/19
D429,916 S *	8/2000	Hurd	.....	D6/436
D515,847 S *	2/2006	Moon et al.	.....	D6/477
D618,419 S *	6/2010	Catron et al.	.....	D34/12
D625,125 S *	10/2010	Buckles et al.	.....	D6/470
D661,141 S *	6/2012	Bao	.....	D6/509
8,297,450 B2 *	10/2012	Zavidniak et al.	.....	211/13.1
D703,466 S *	4/2014	Franck et al.	.....	D6/675

\* cited by examiner

Primary Examiner — Kelley Donnelly

(74) *Attorney, Agent, or Firm* — Myers Bigel Sibley & Sajovec, PA

(57) **CLAIM**

The ornamental design for an extendable and versatile rack, as shown and described.

**DESCRIPTION**

FIG. 1 is a front perspective view illustrating an extendable and versatile rack in an upright position;  
 FIG. 2 is a top view thereof;  
 FIG. 3 is a bottom view thereof;  
 FIG. 4 is a front view thereof;  
 FIG. 5 is a back view thereof;  
 FIG. 6 is a side view thereof;  
 FIG. 7 is an opposing side view thereof;  
 FIG. 8 is a front perspective view illustrating the extendable and versatile rack in an extended position;  
 FIG. 9 is a top view thereof;  
 FIG. 10 is a bottom view thereof;  
 FIG. 11 is a front view thereof;  
 FIG. 12 is a back view thereof;  
 FIG. 13 is a side view thereof;  
 FIG. 14 is an opposing side view thereof;  
 FIG. 15 is a front perspective view illustrating another embodiment of an extendable and versatile rack in an upright position;  
 FIG. 16 is a top view thereof;  
 FIG. 17 is a bottom view thereof;  
 FIG. 18 is a front view thereof;  
 FIG. 19 is a back view thereof;  
 FIG. 20 is a side view thereof;  
 FIG. 21 is an opposing side view thereof;  
 FIG. 22 is a front perspective view illustrating the extendable and versatile rack in an extended position;  
 FIG. 23 is a top view thereof;  
 FIG. 24 is a bottom view thereof;  
 FIG. 25 is a front view thereof;  
 FIG. 26 is a back view thereof;  
 FIG. 27 is a side view thereof; and,  
 FIG. 28 is an opposing side view thereof.

The broken lines shown herein are for illustrative purposes only and form no part of the claimed design.

**1 Claim, 22 Drawing Sheets**

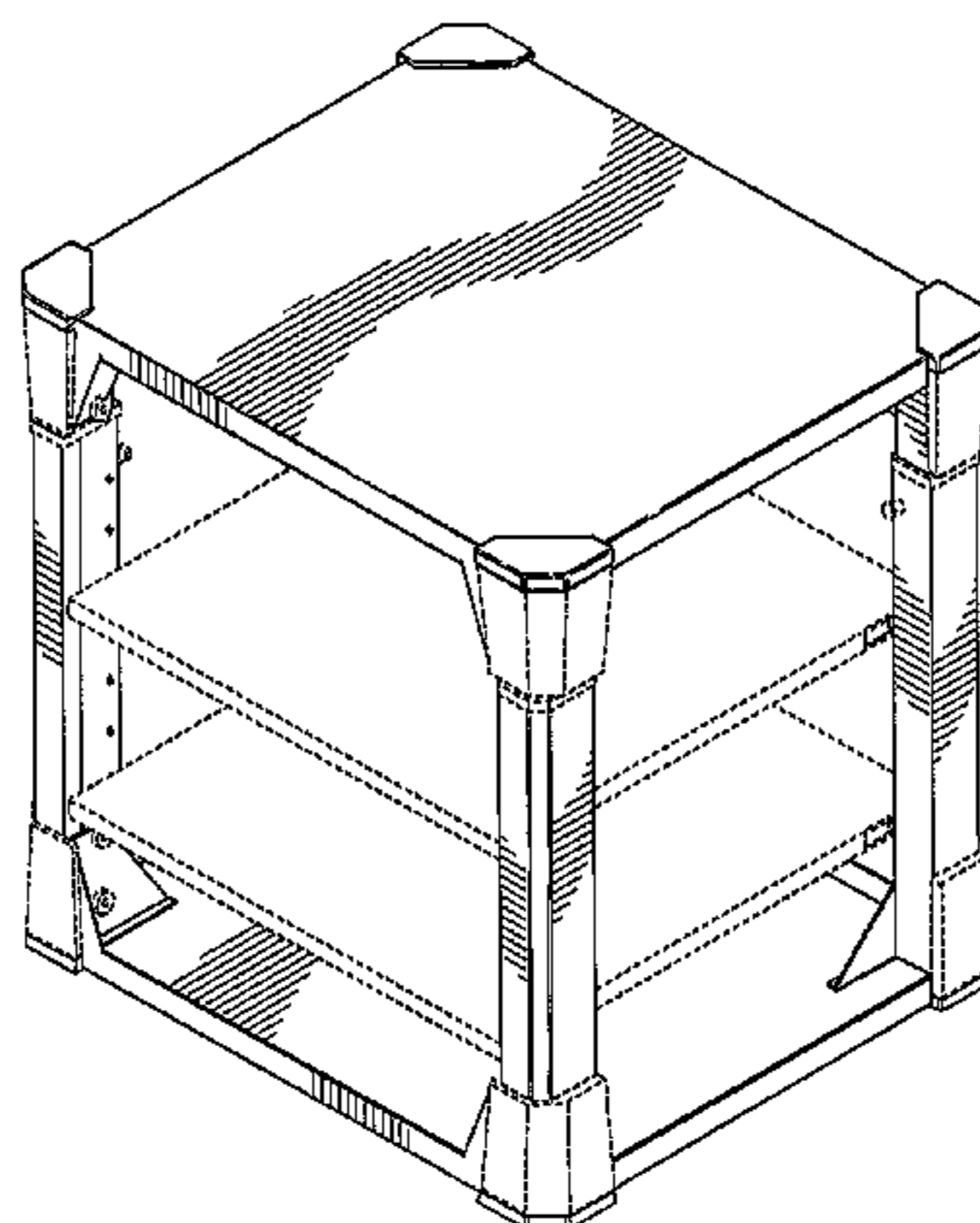

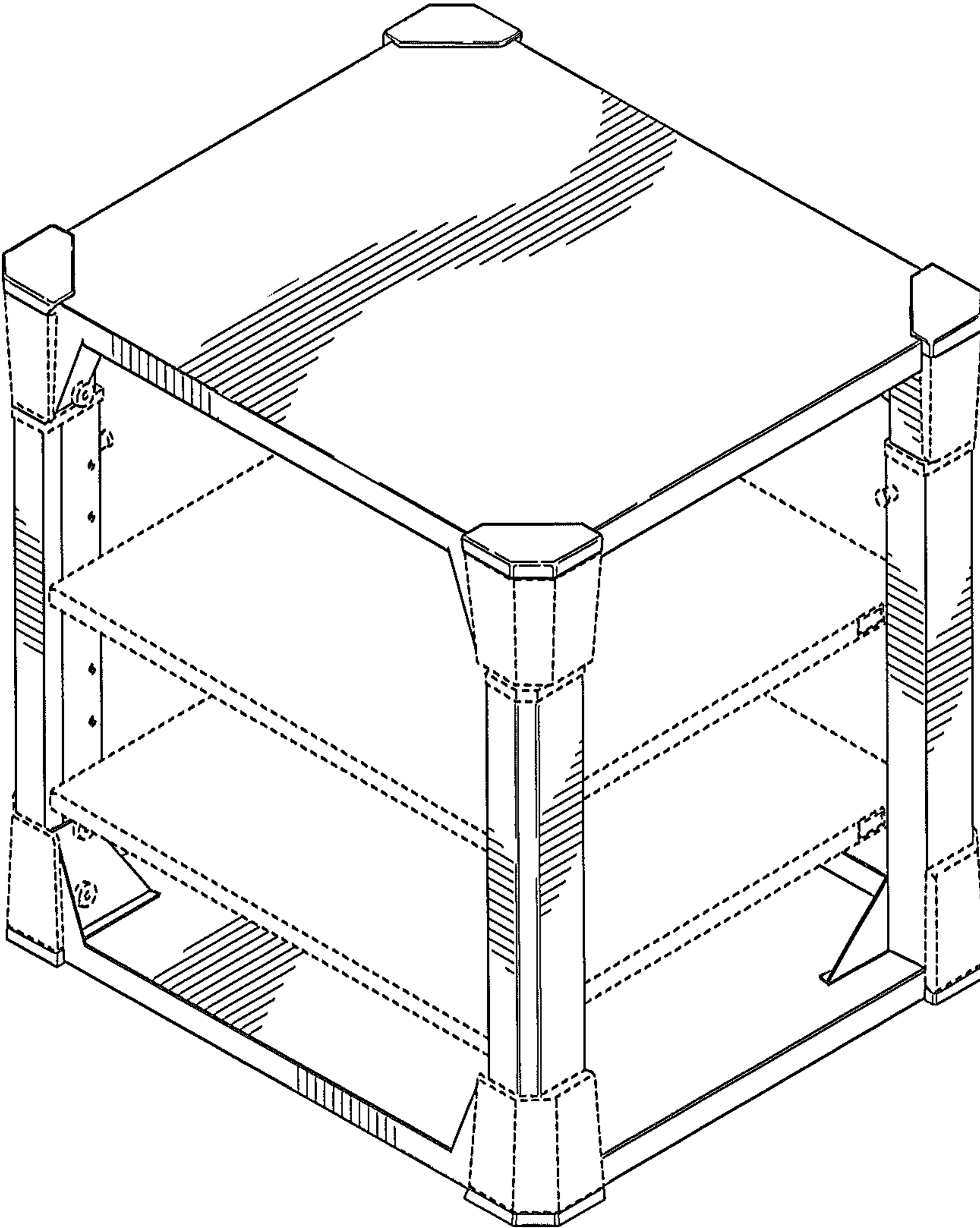

FIG. 1

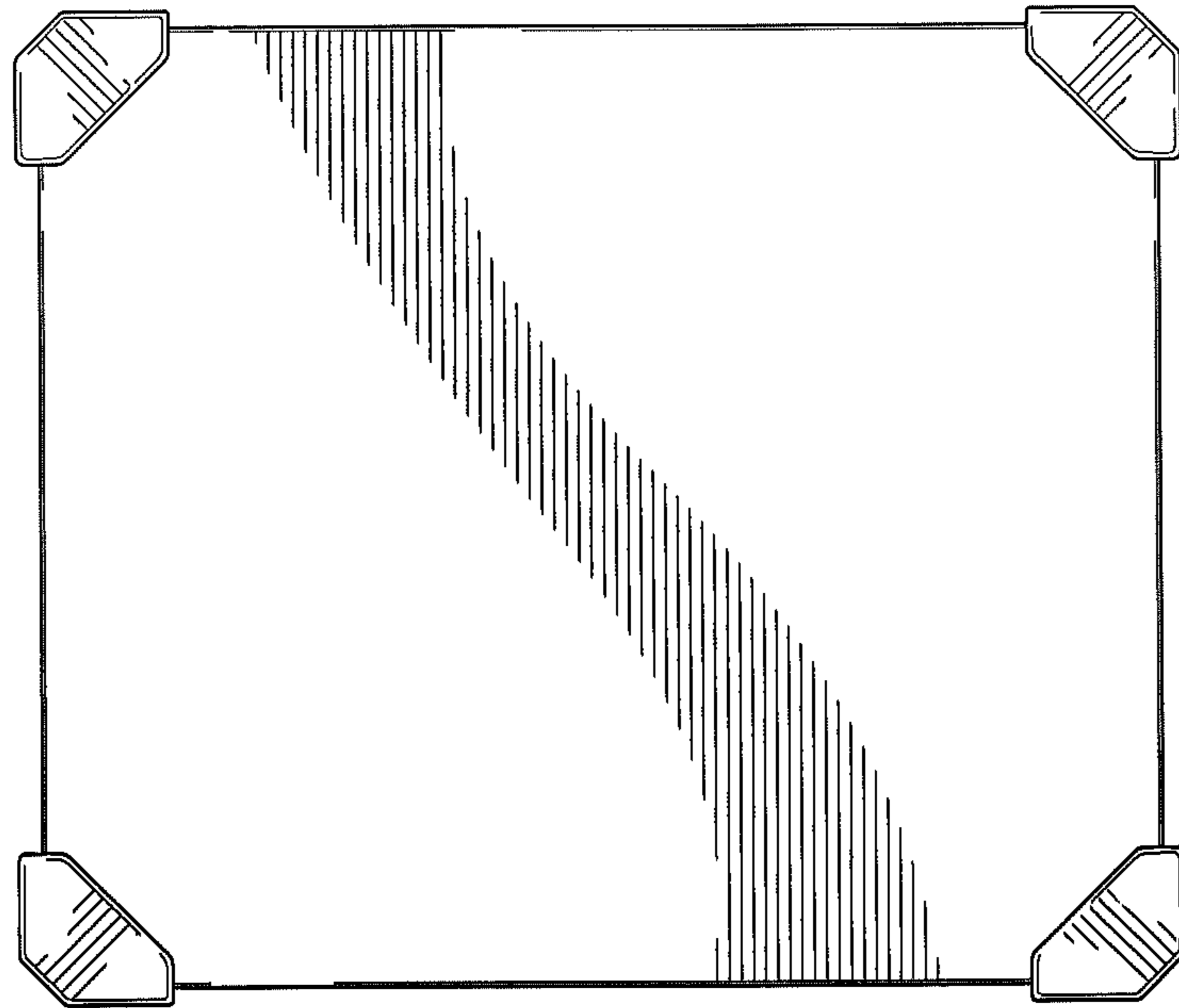

FIG. 2

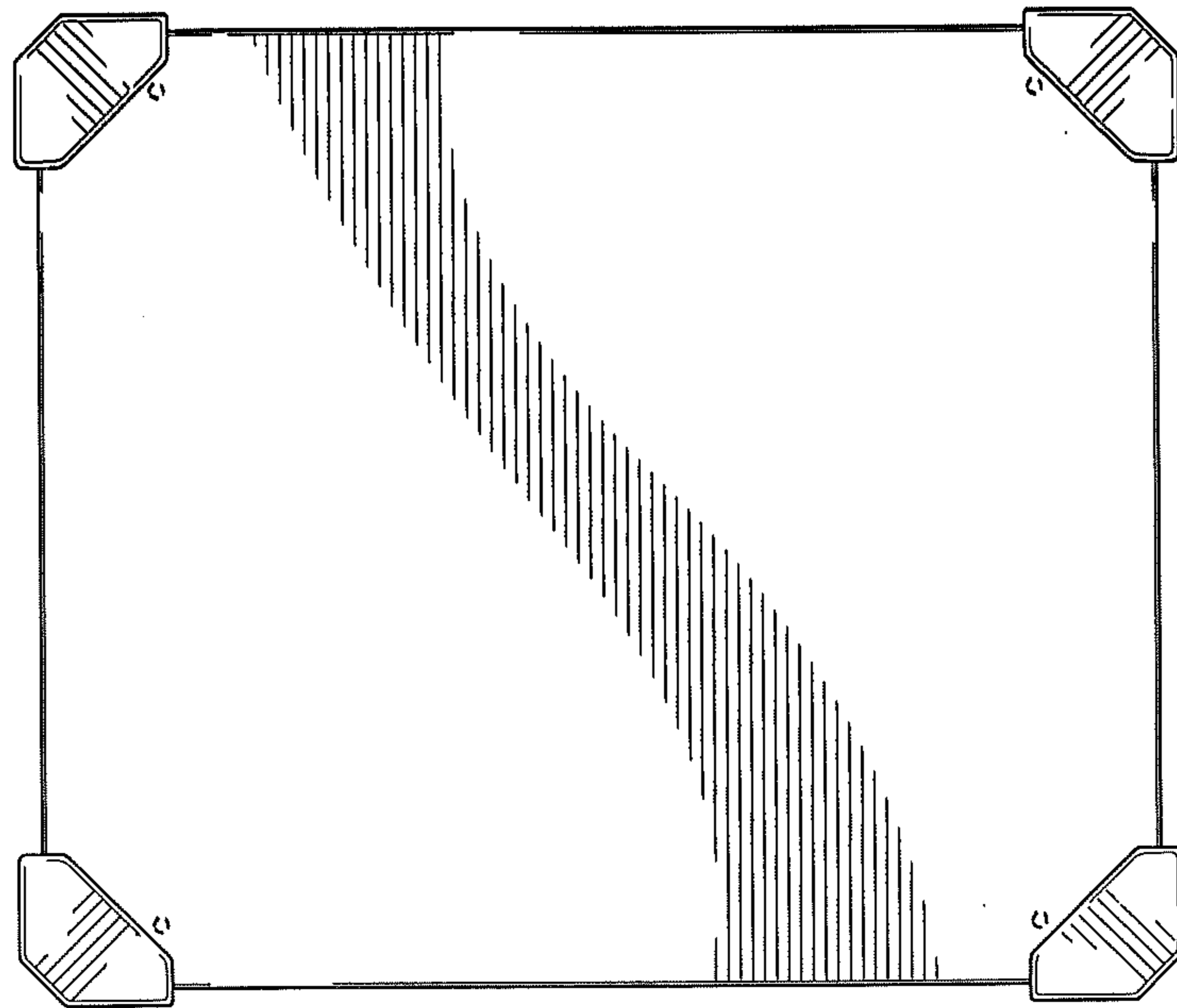

FIG. 3

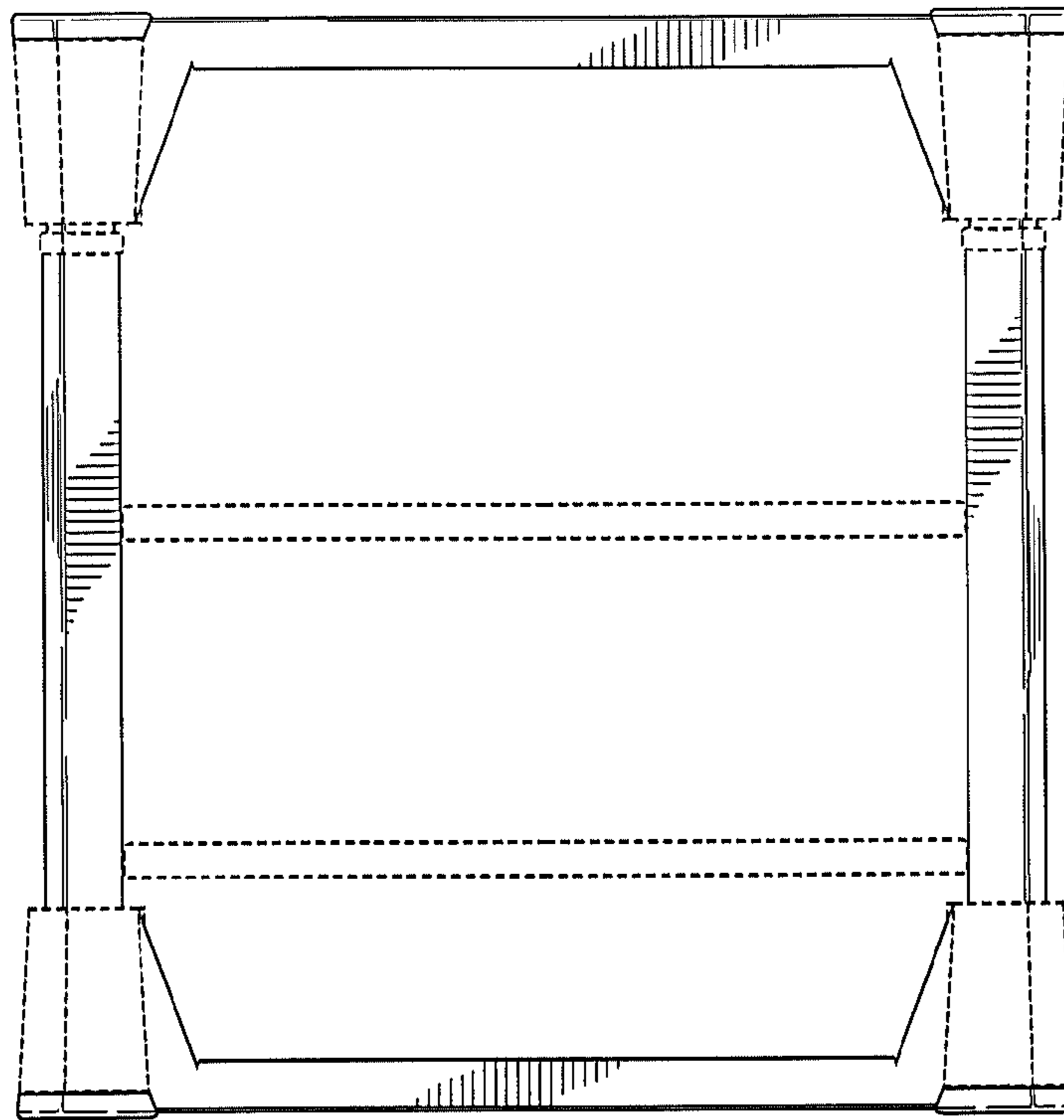

FIG. 4

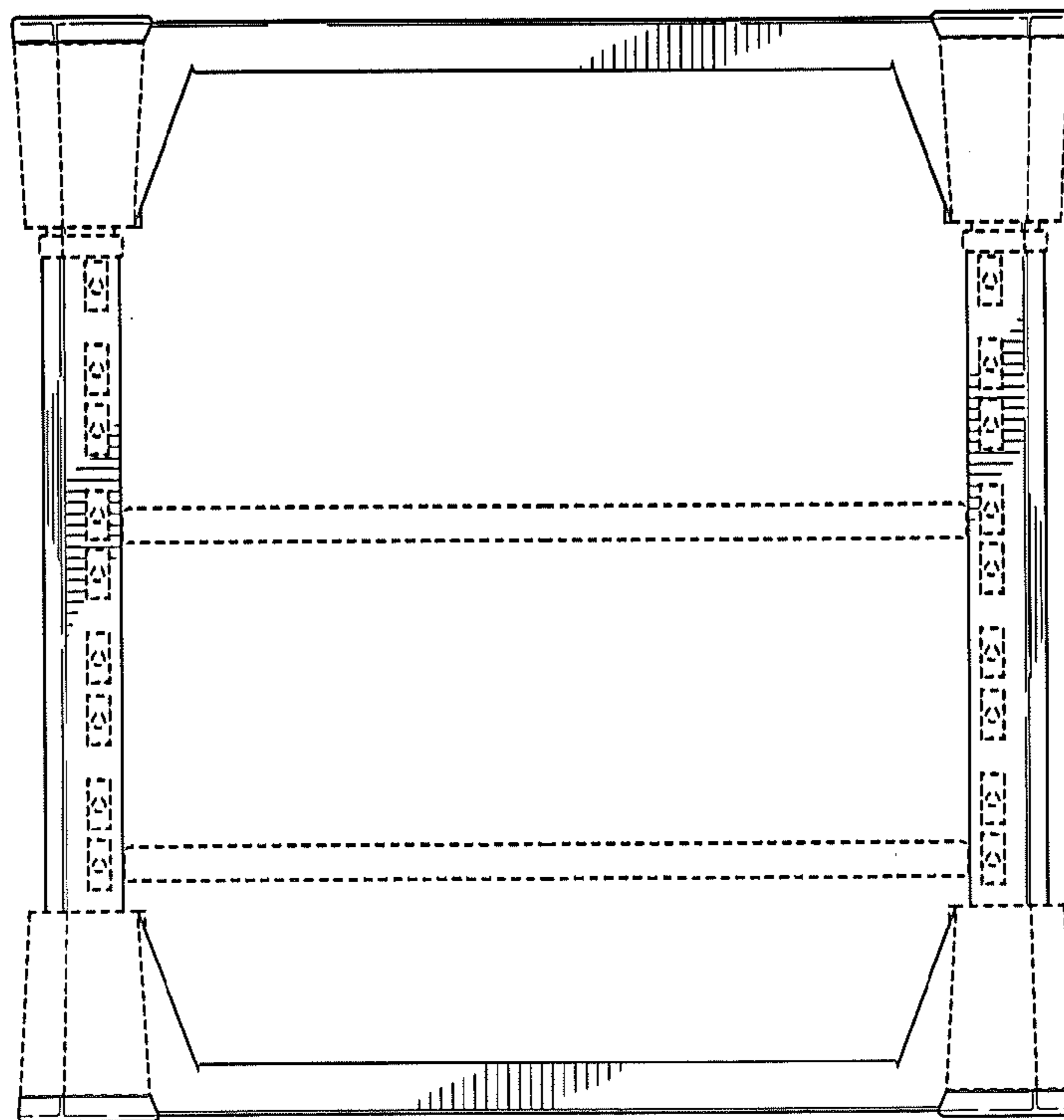

FIG. 5

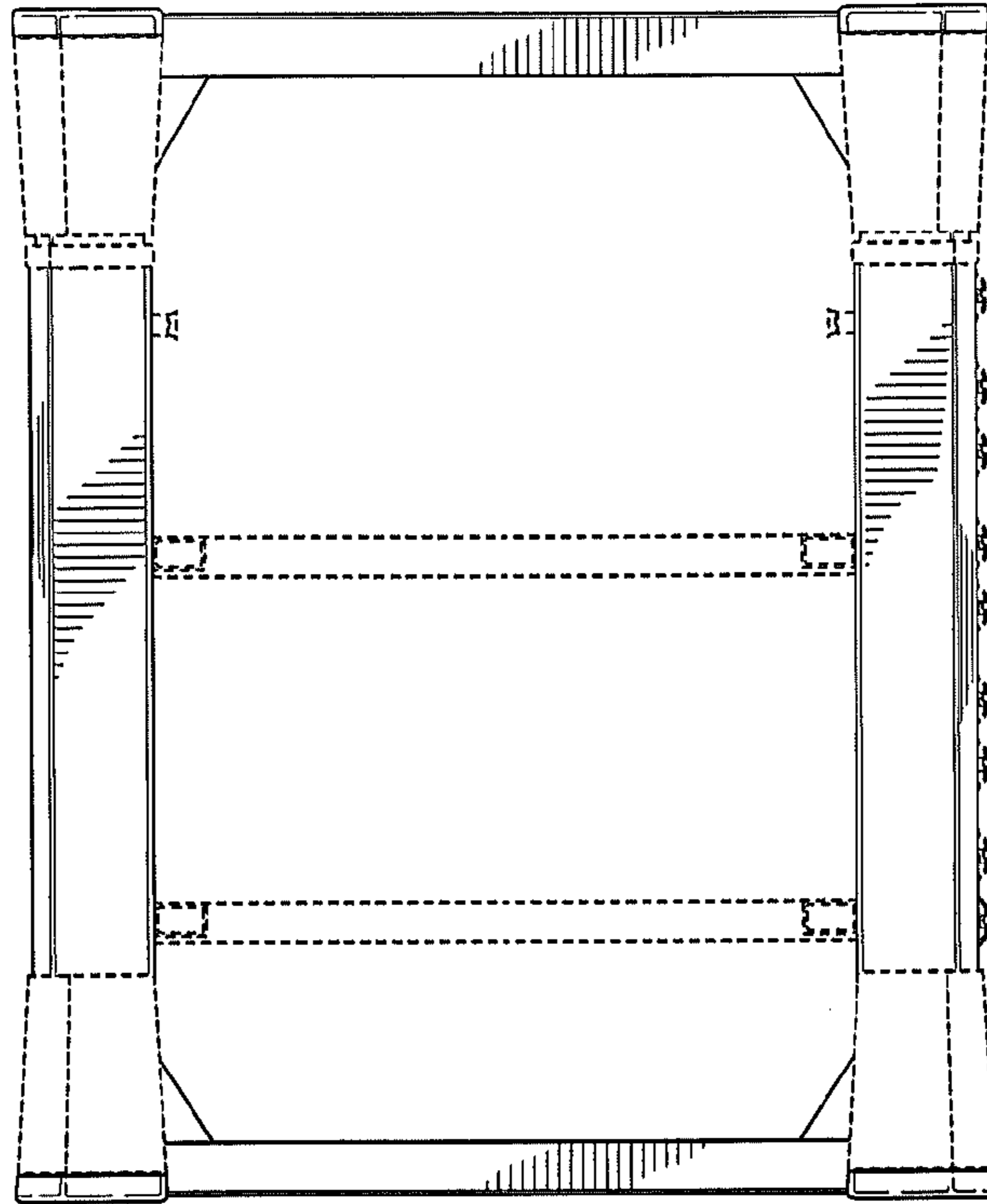

FIG. 6

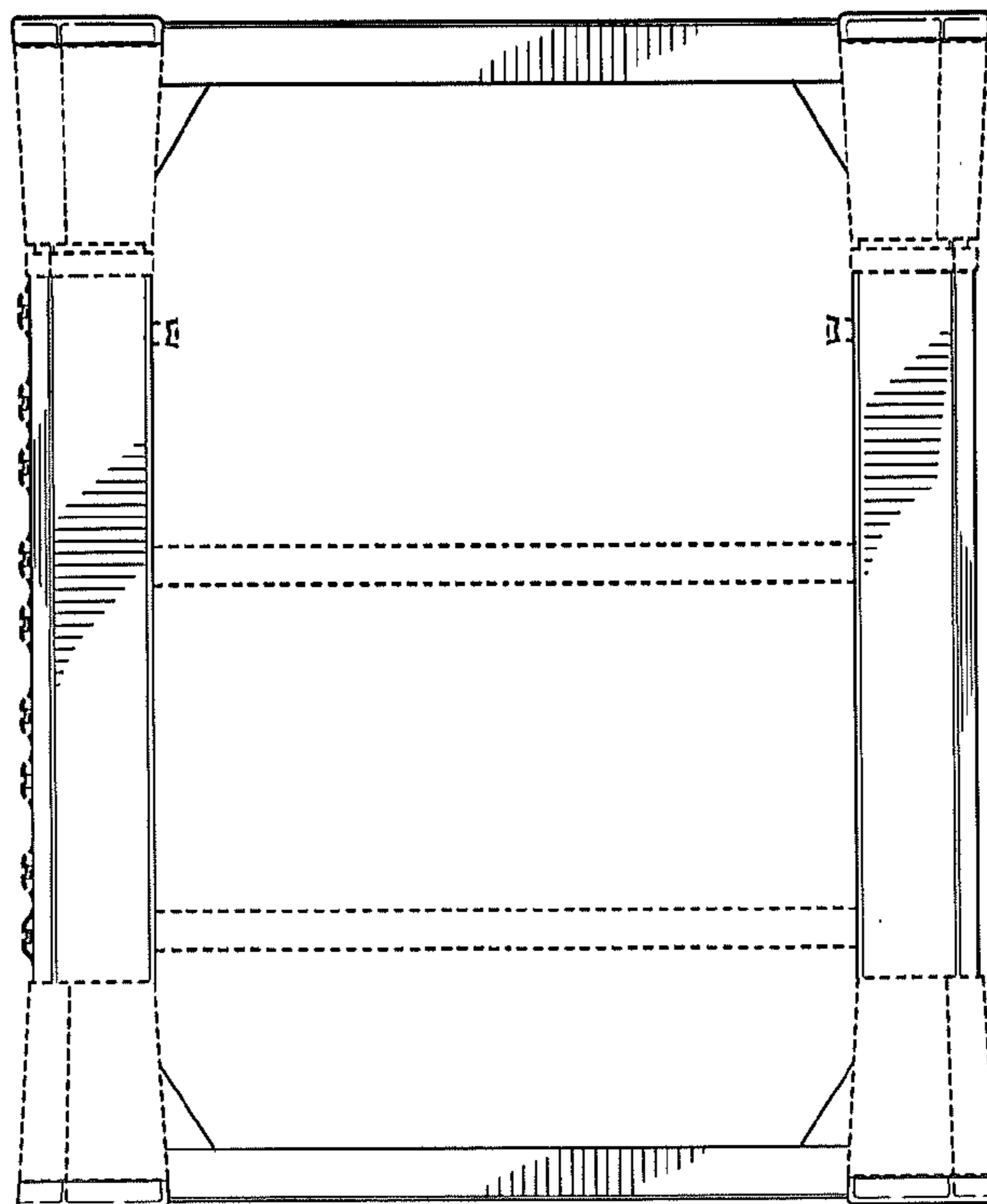

FIG. 7

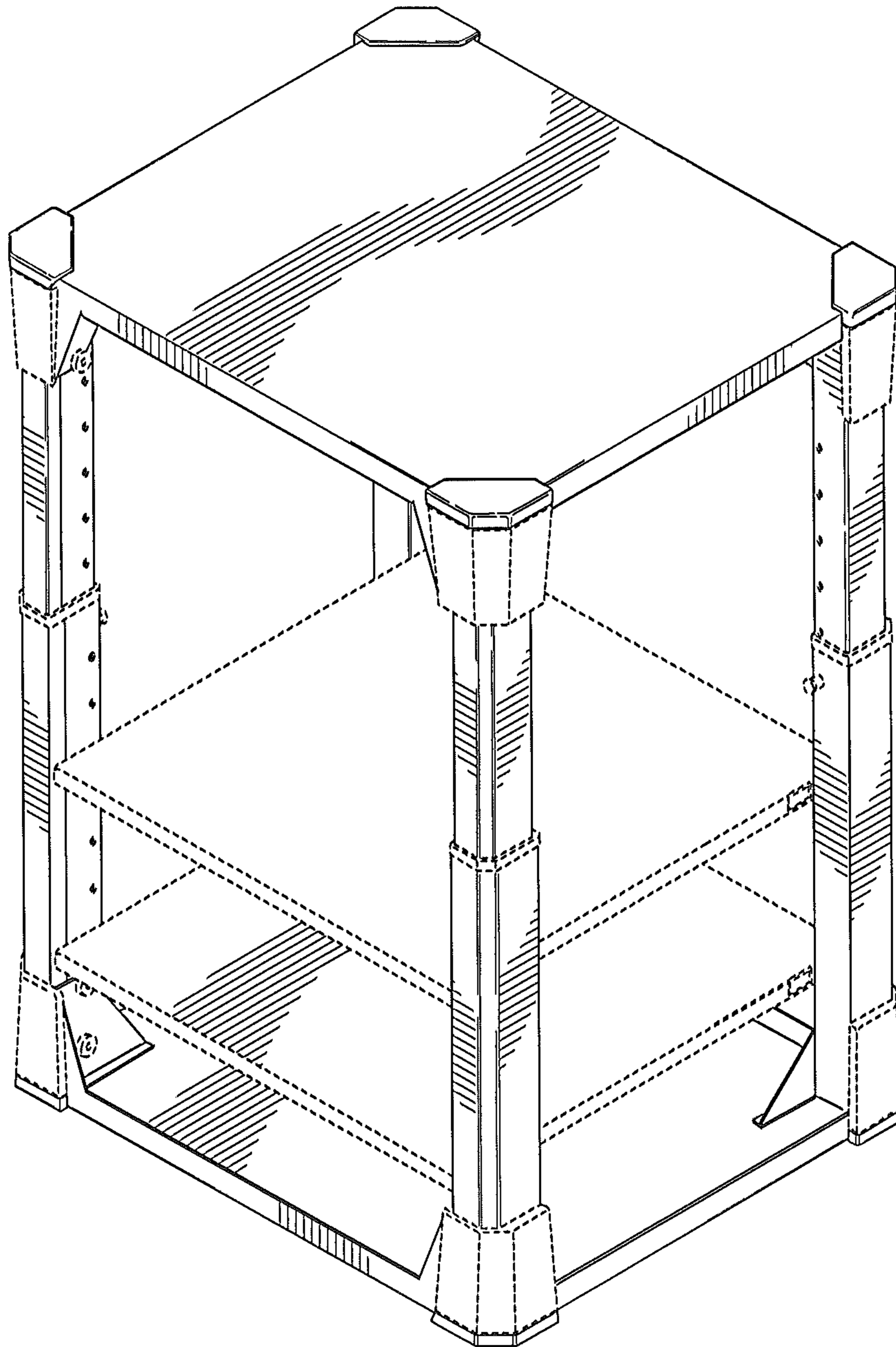

FIG. 8

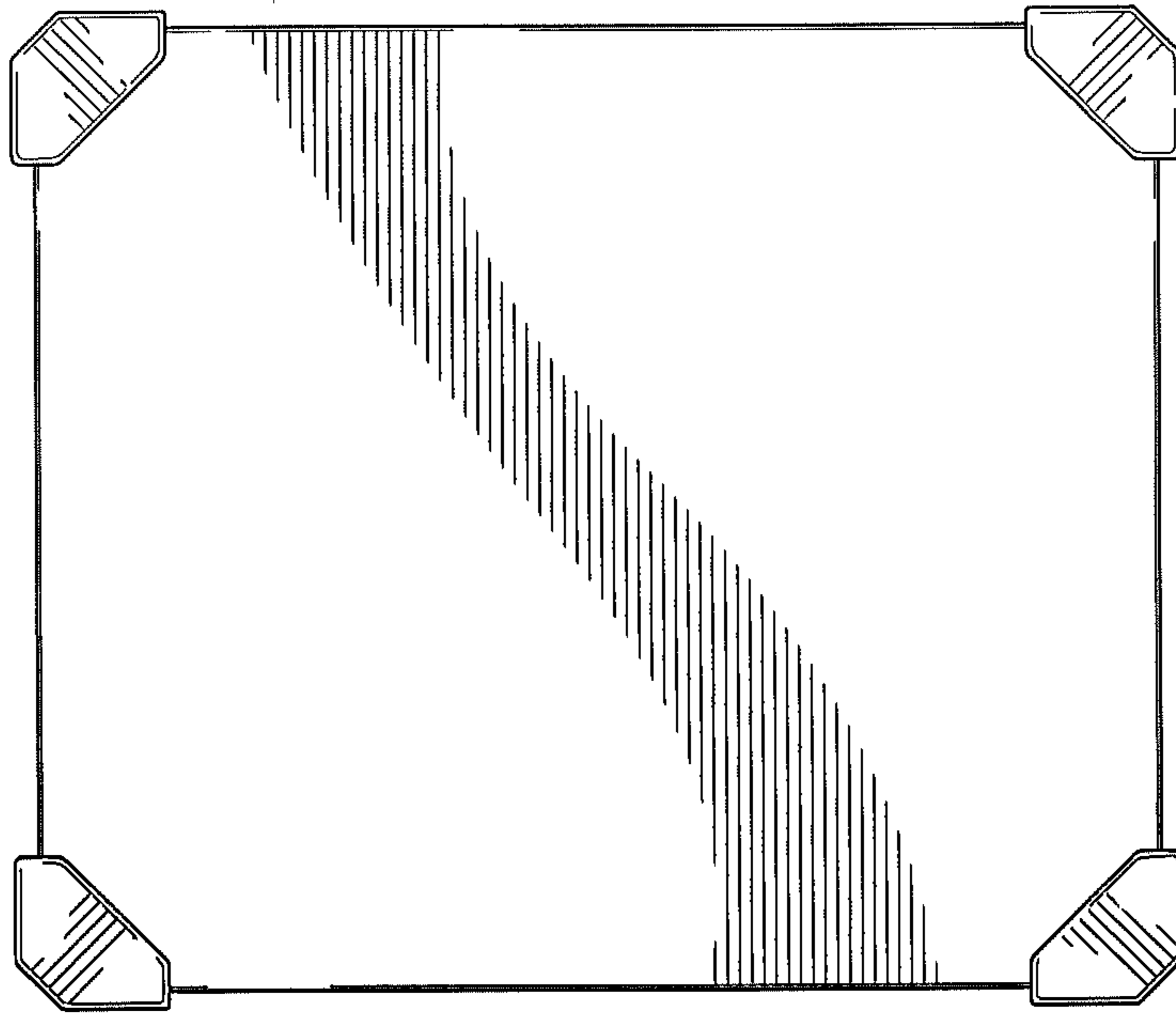

FIG. 9

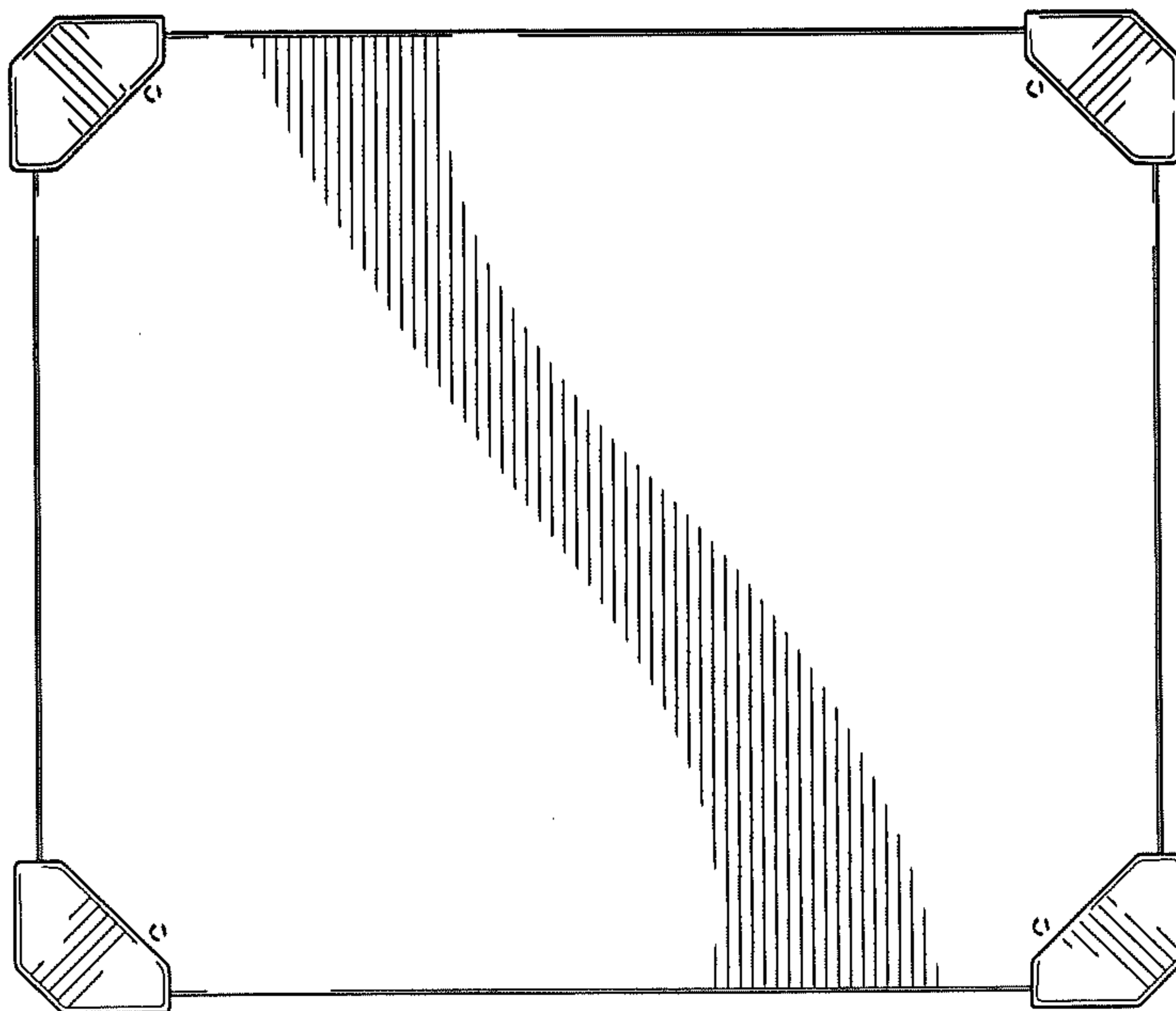

FIG. 10

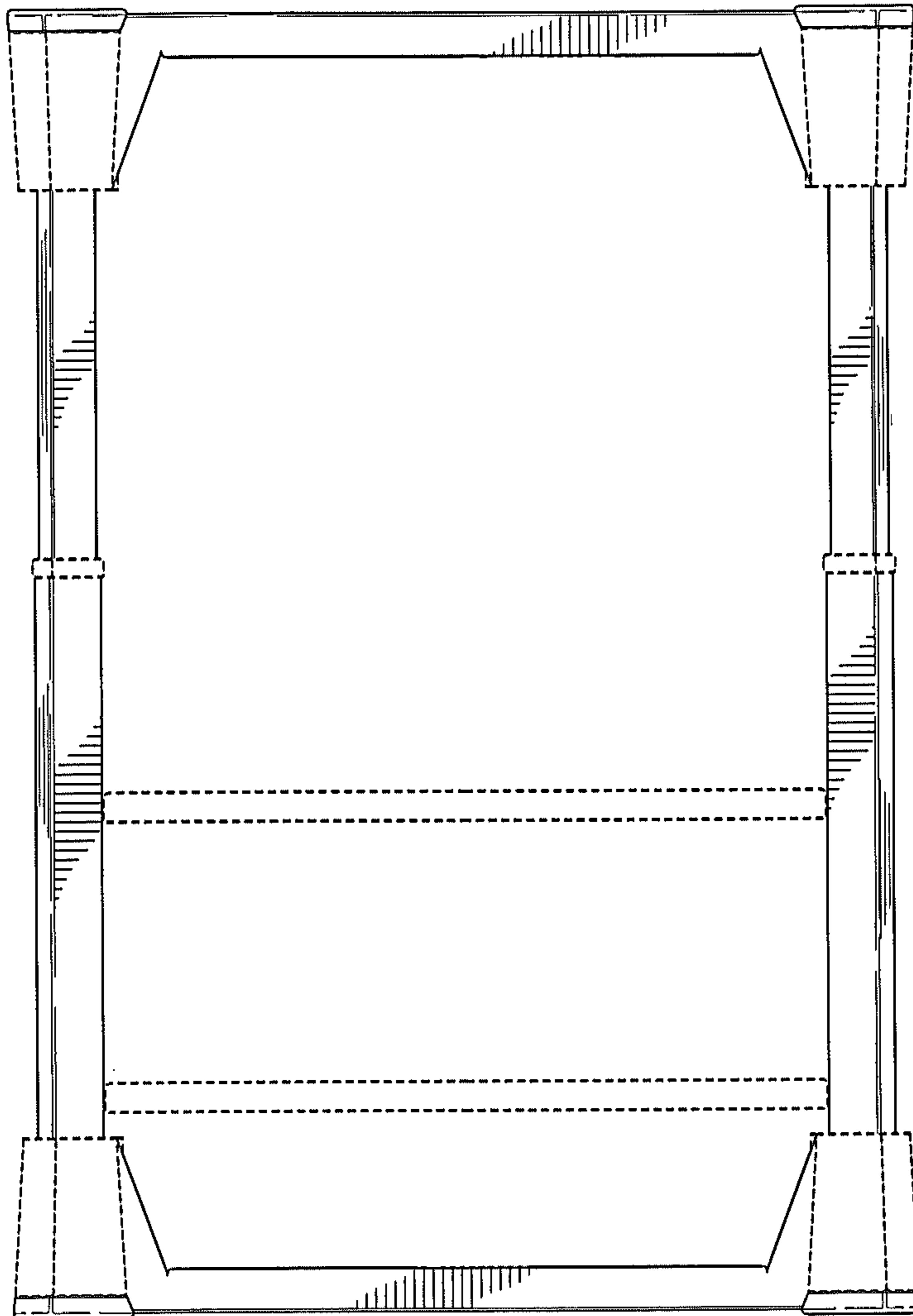

FIG. 11



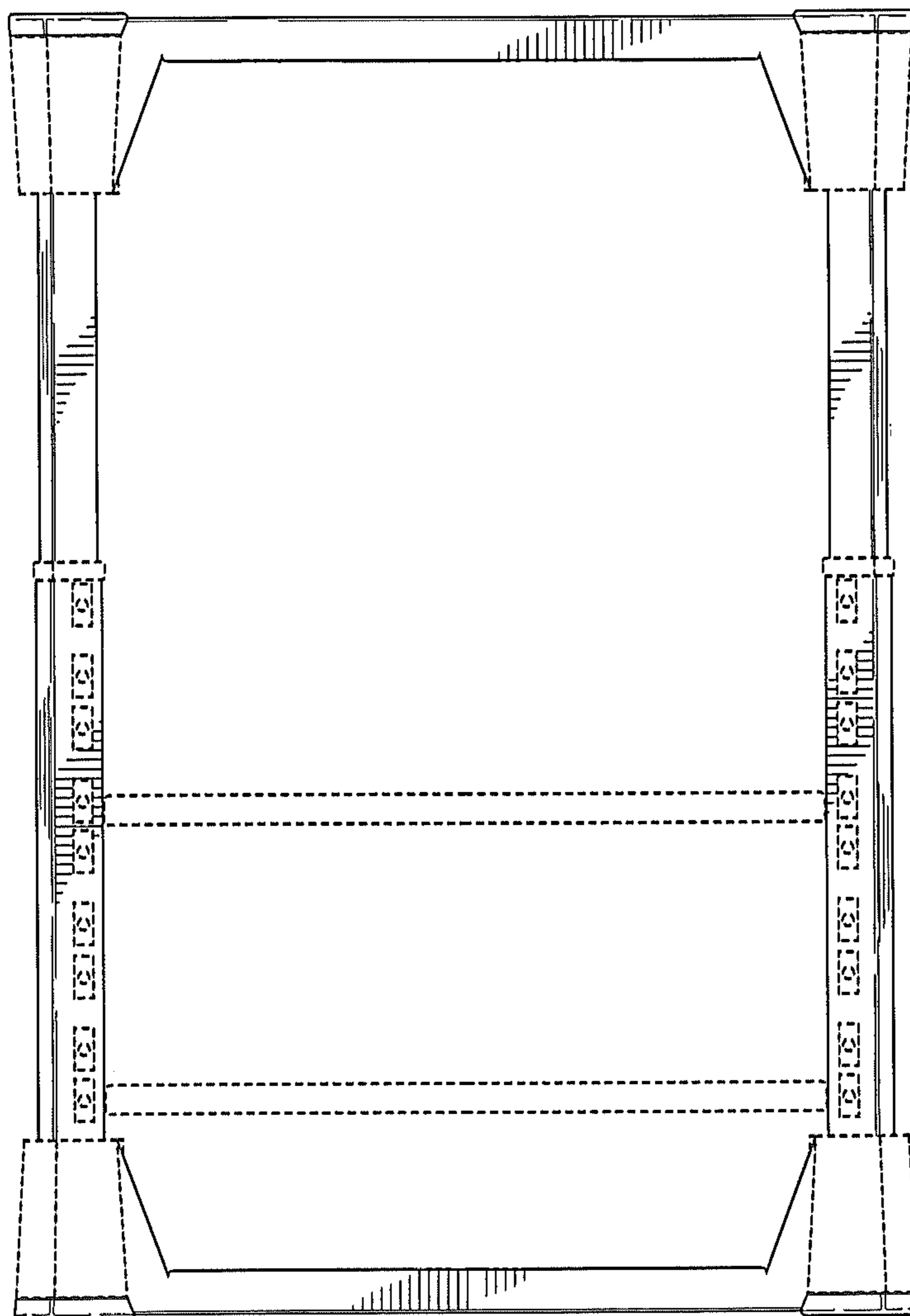

FIG. 12

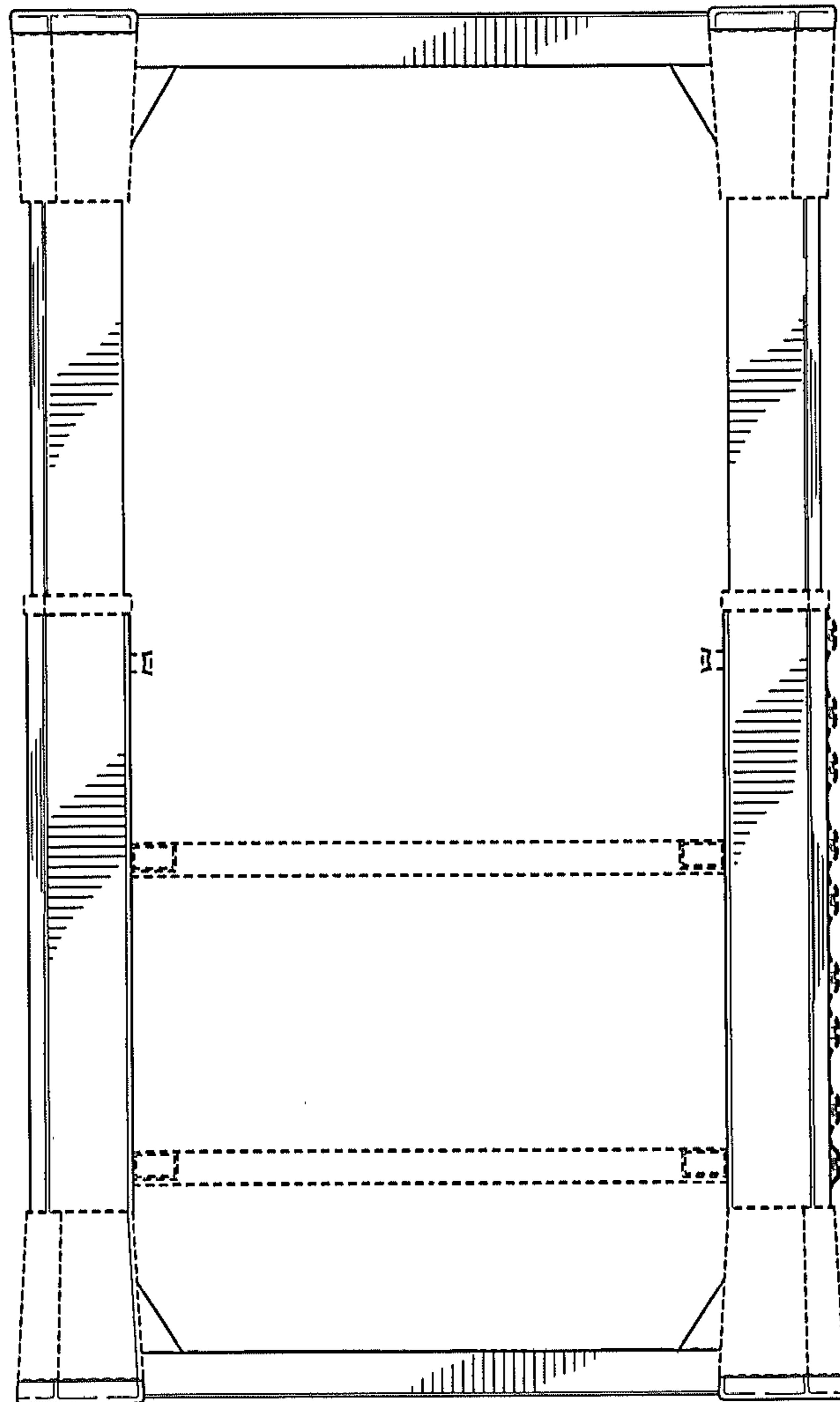

FIG. 13

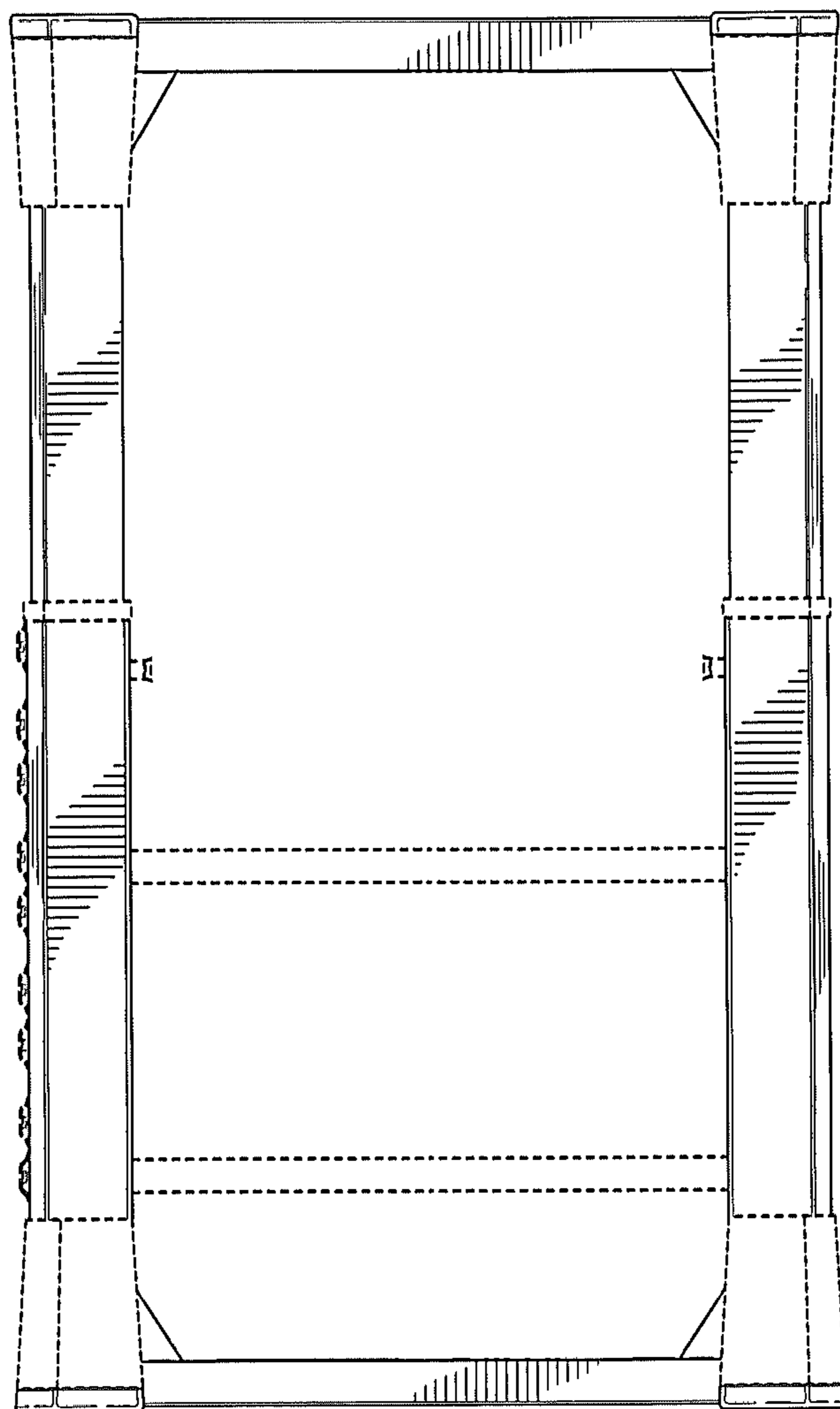

FIG. 14

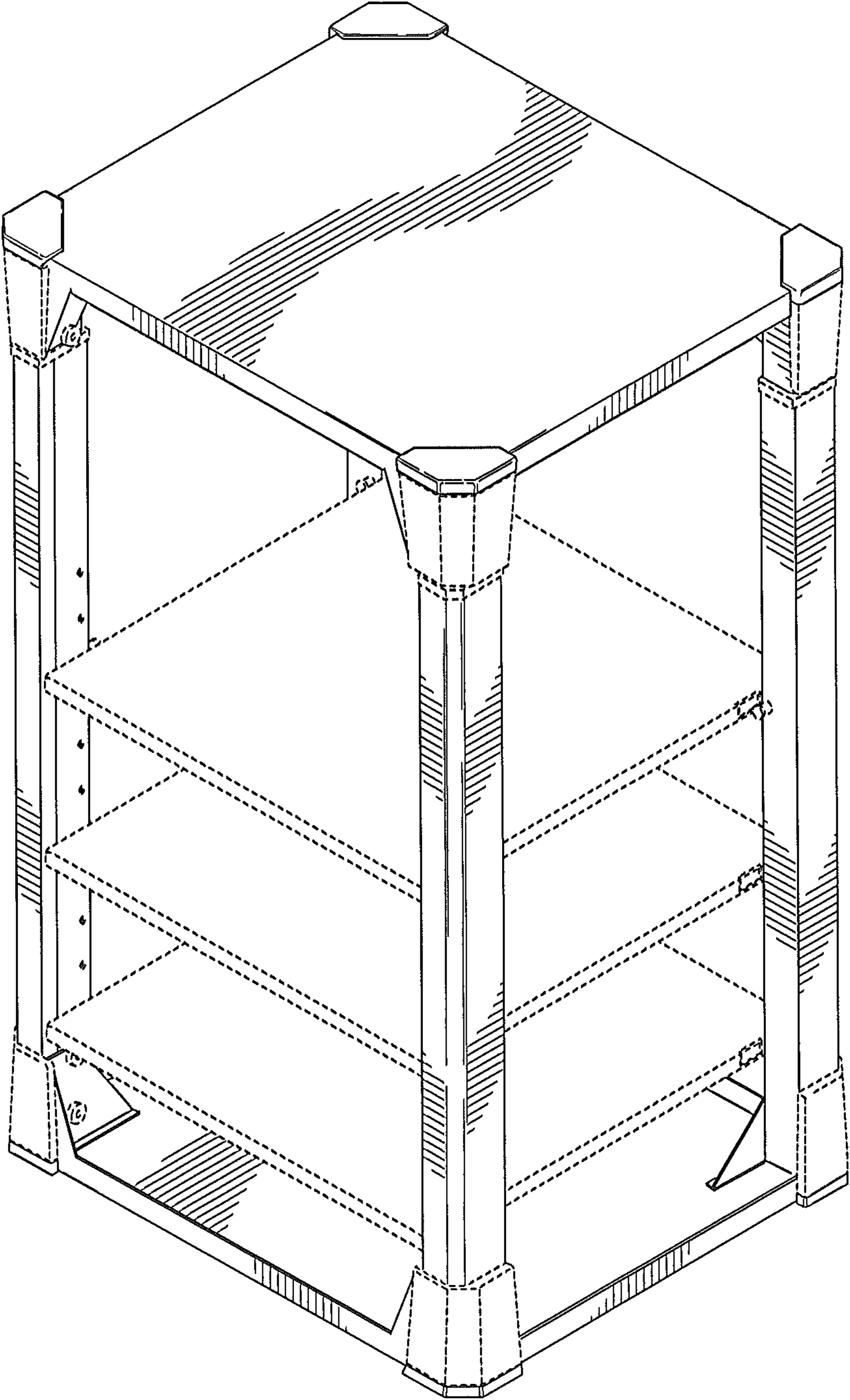

FIG. 15

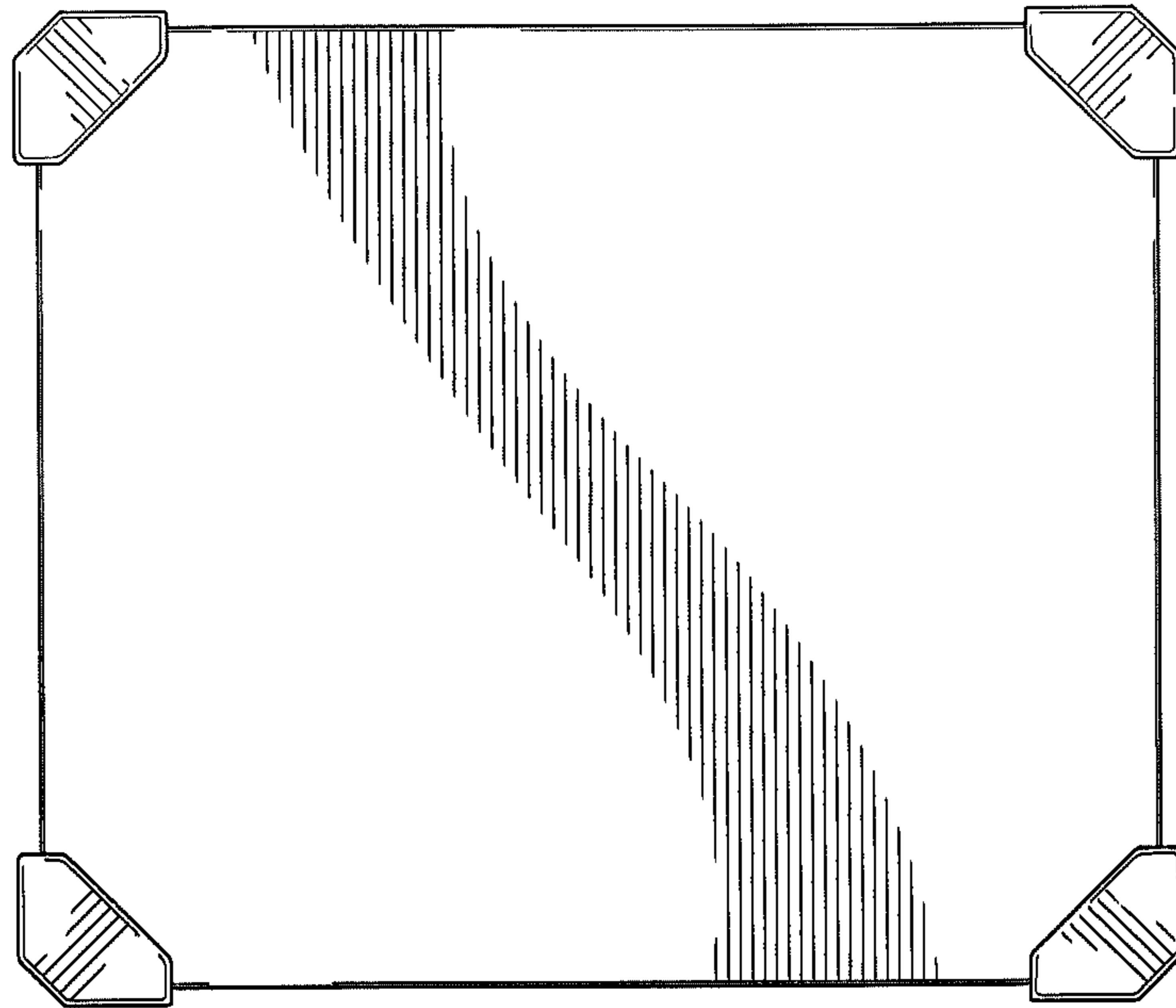

FIG. 16

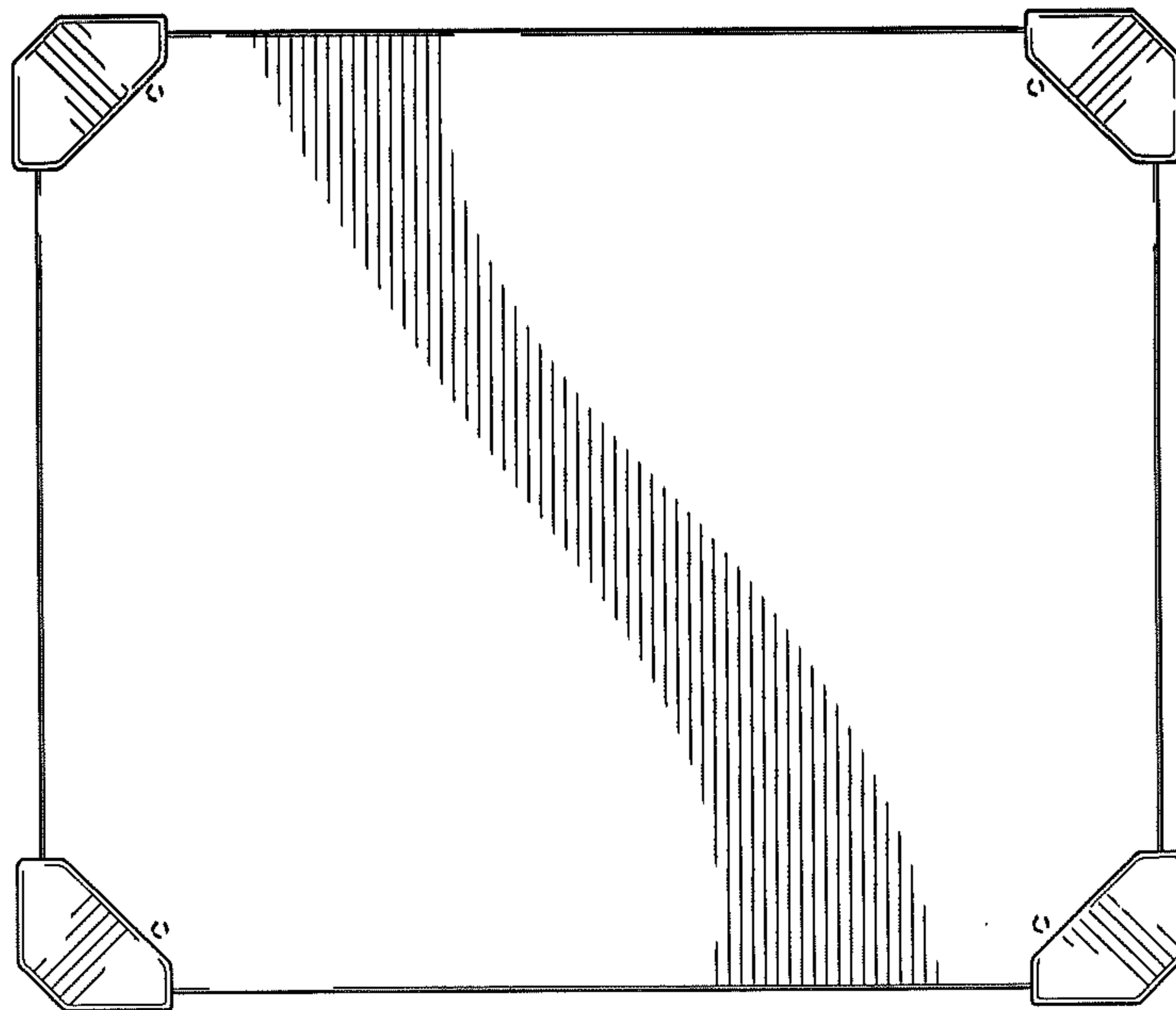

FIG. 17

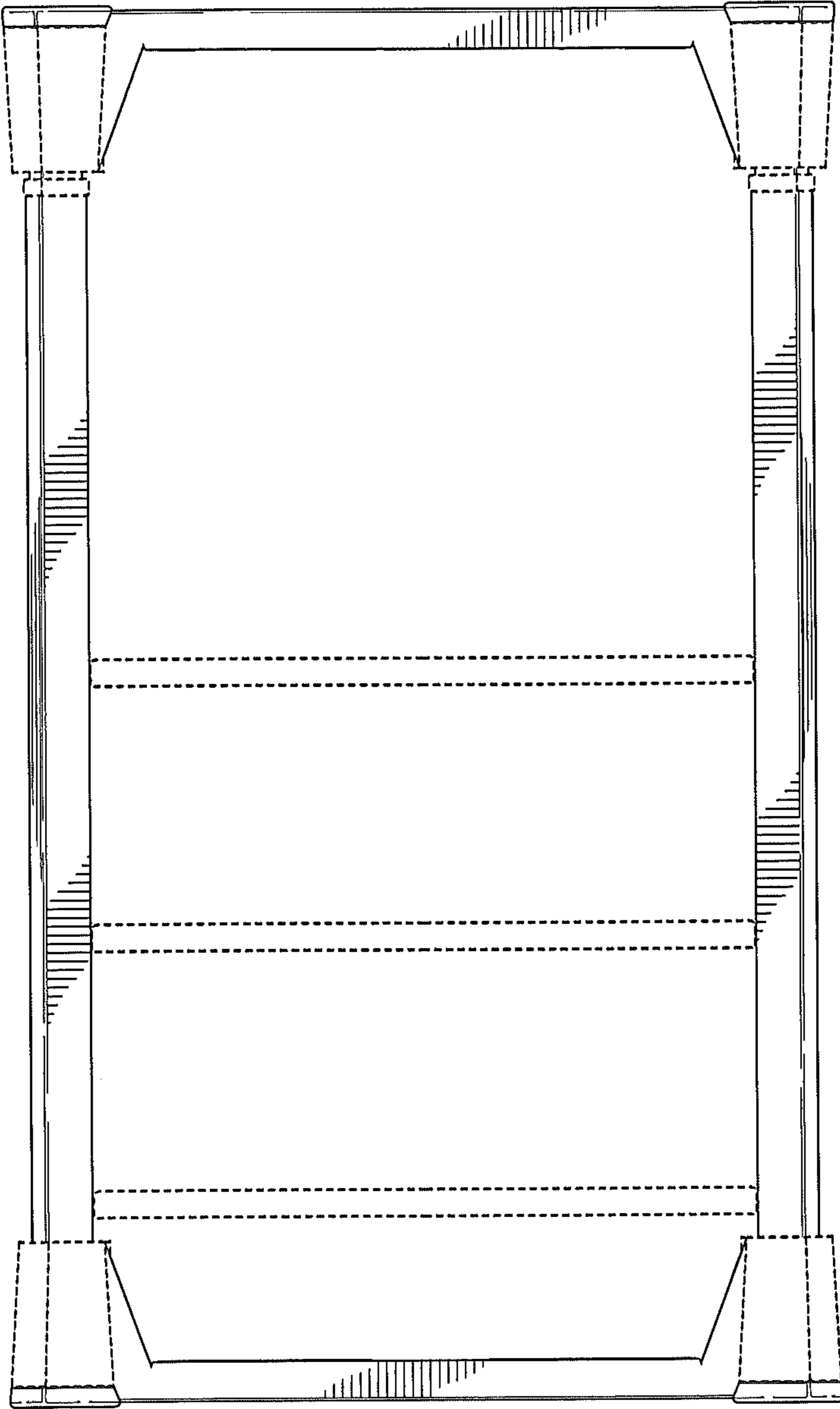

FIG. 18

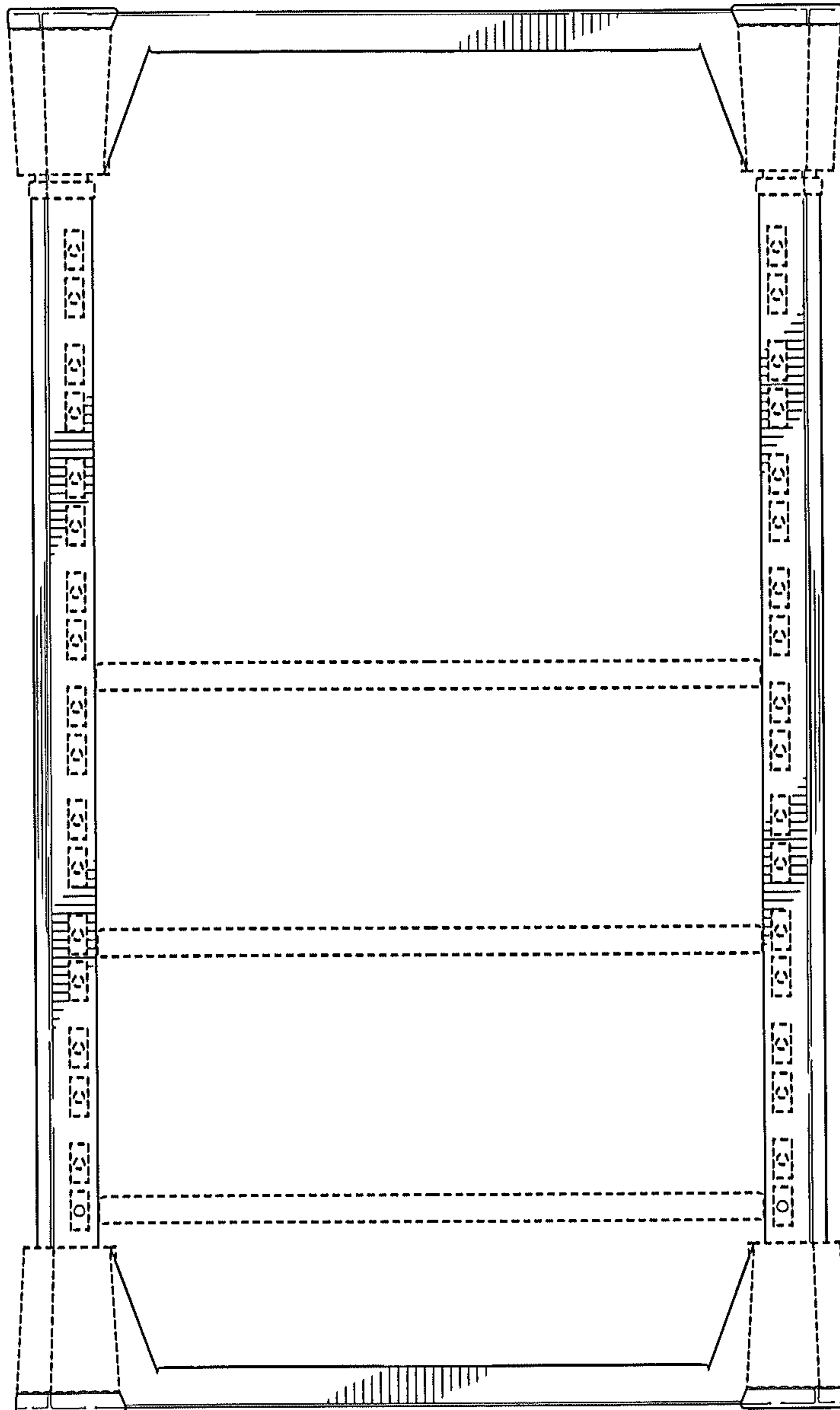

FIG. 19

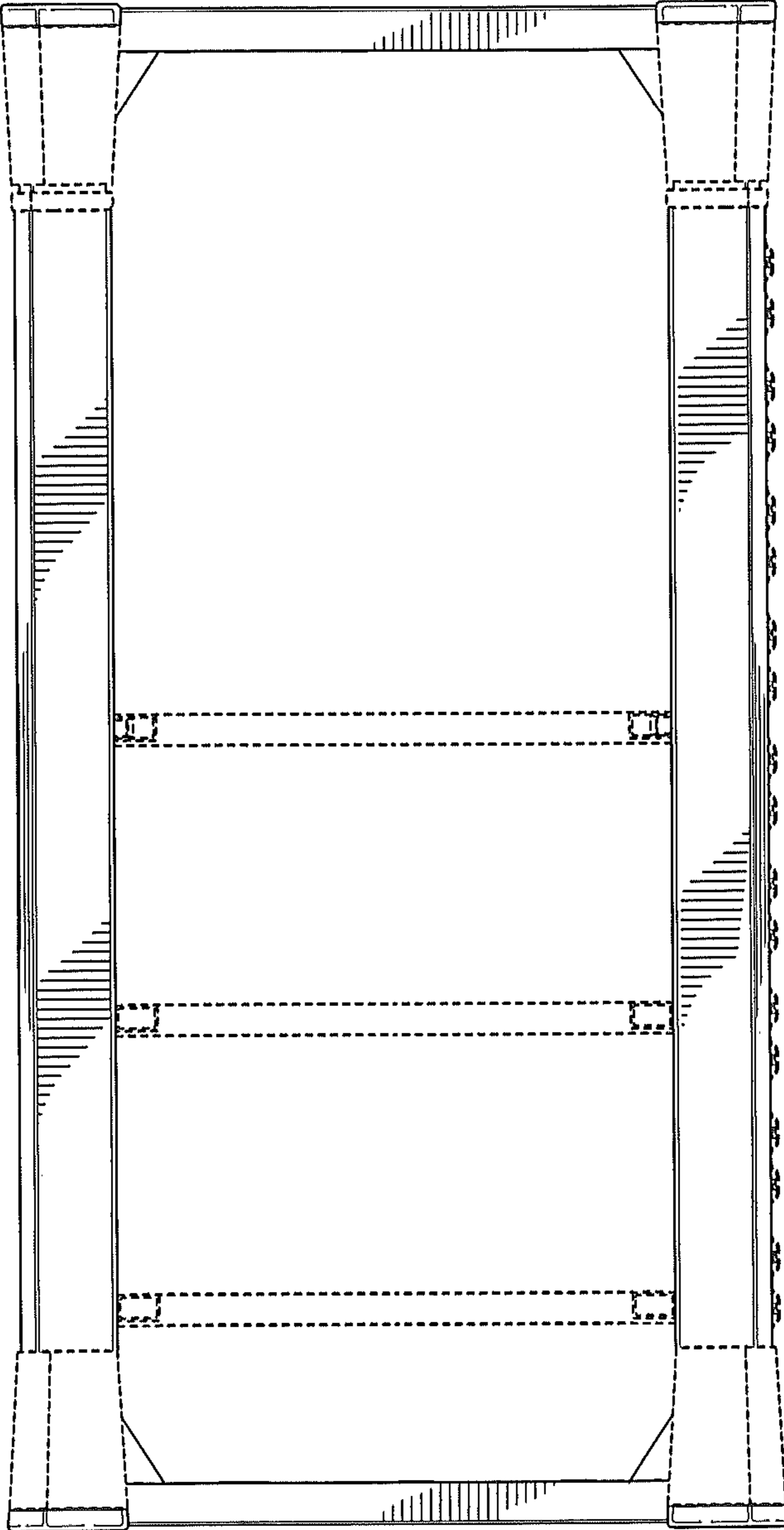

FIG. 20



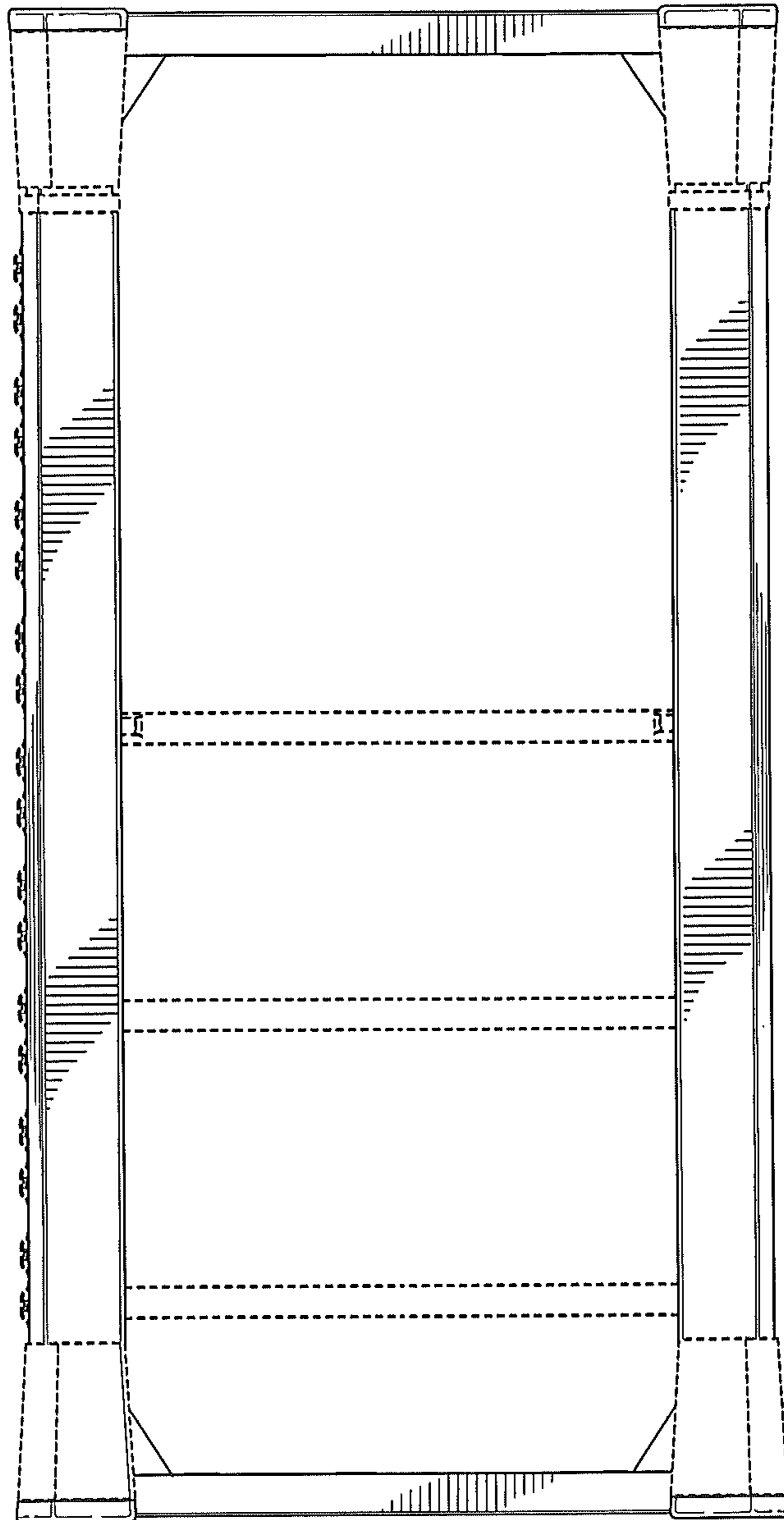

FIG. 21

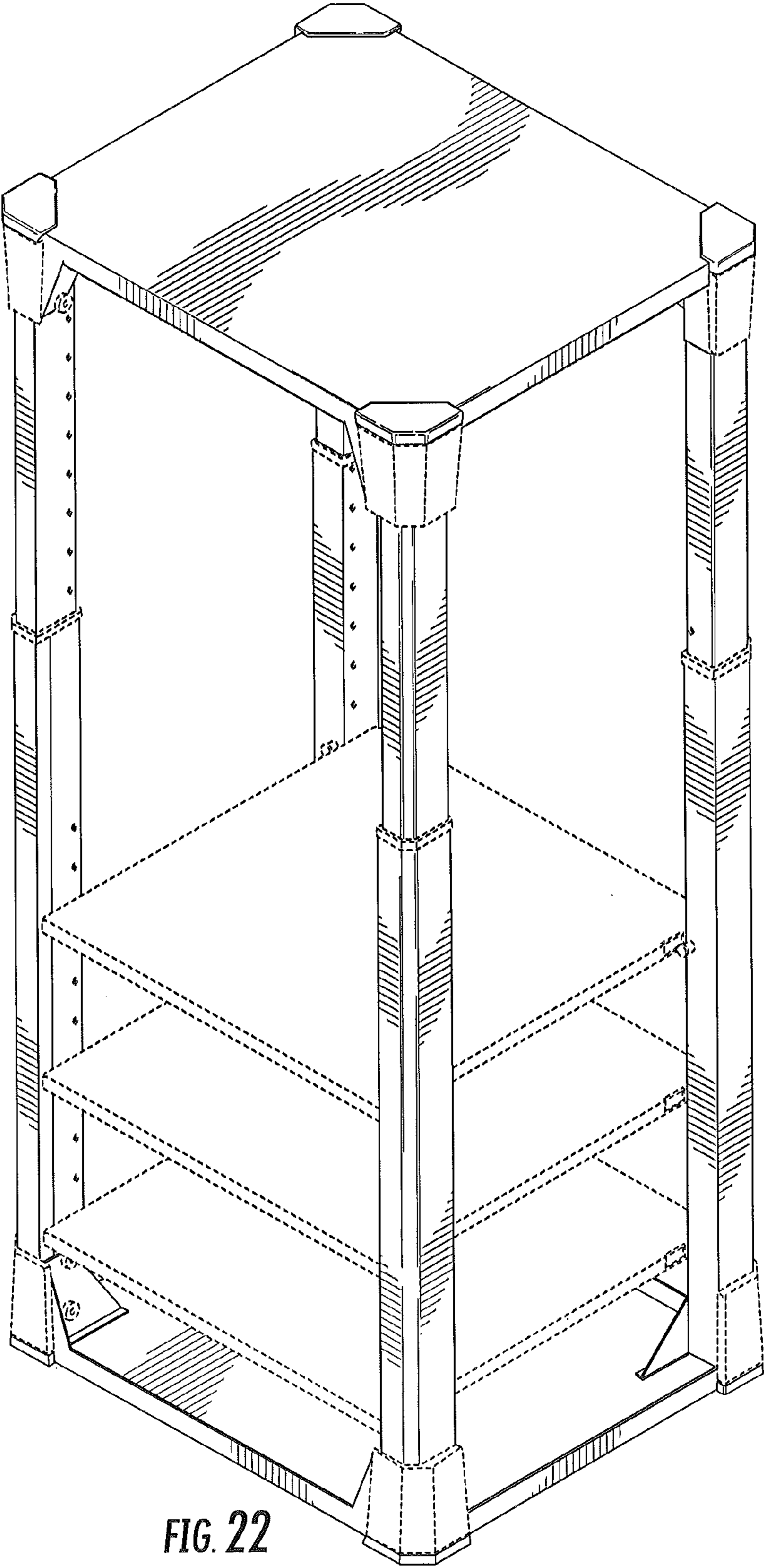

FIG. 22

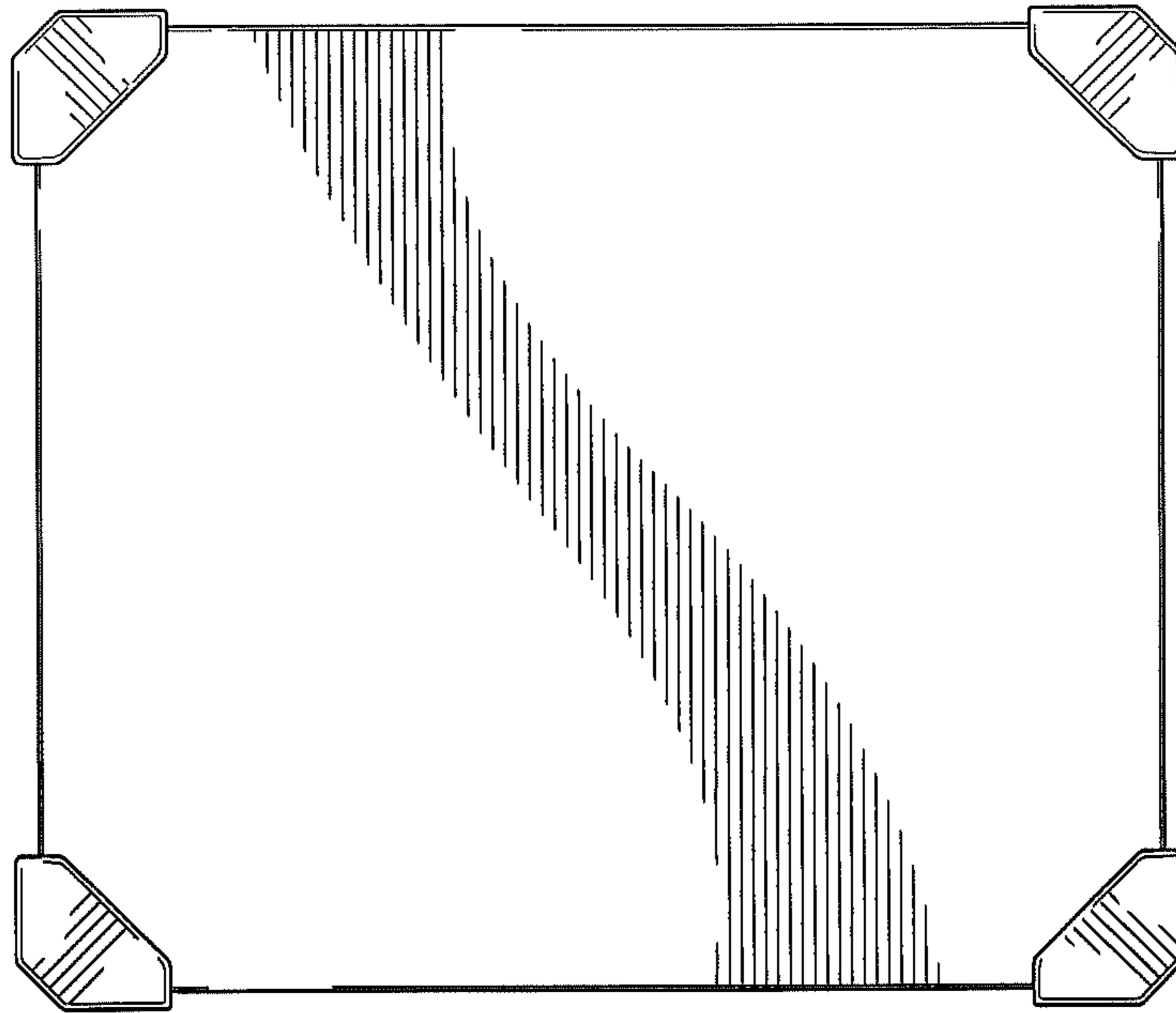

FIG. 23

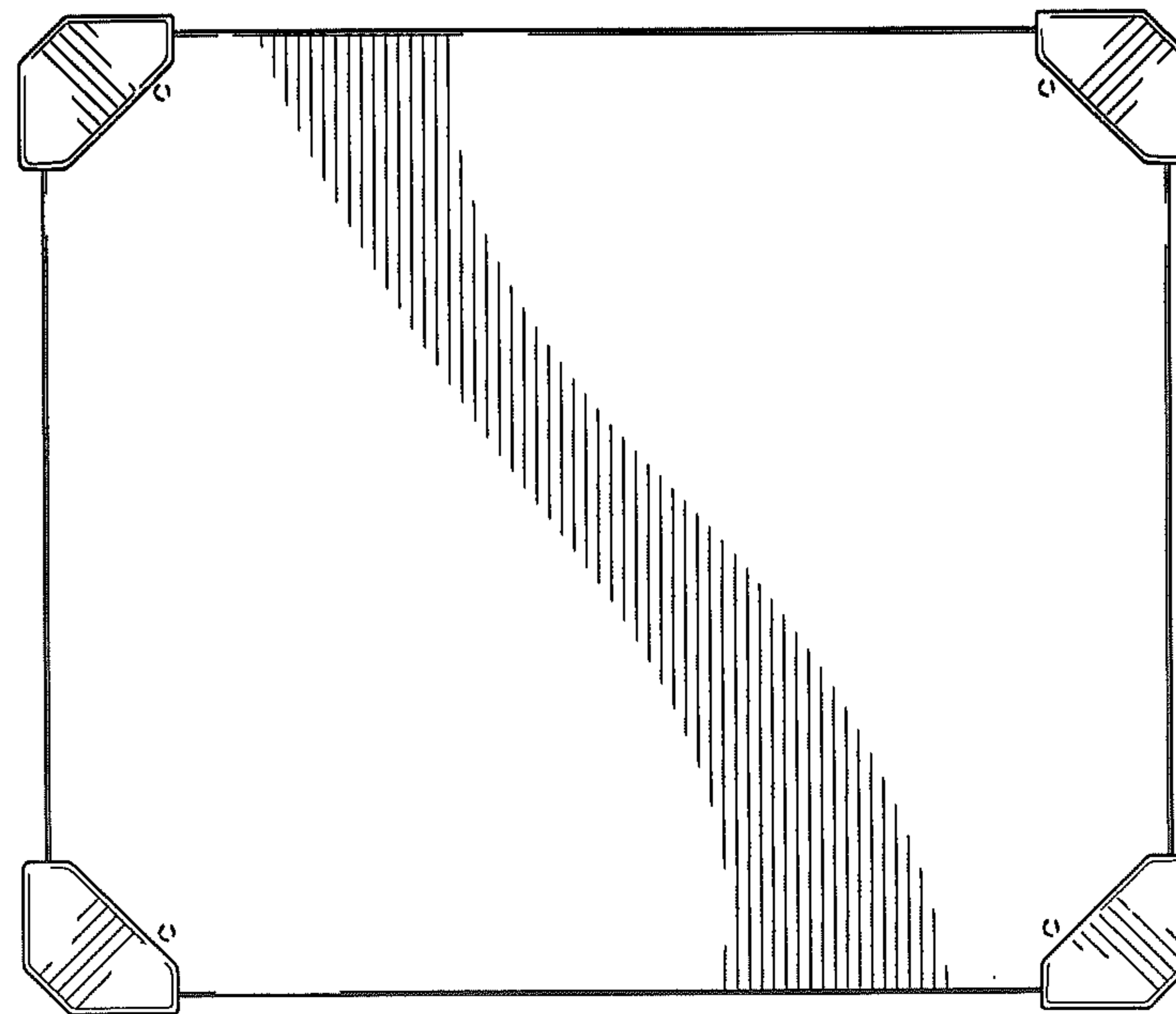

FIG. 24

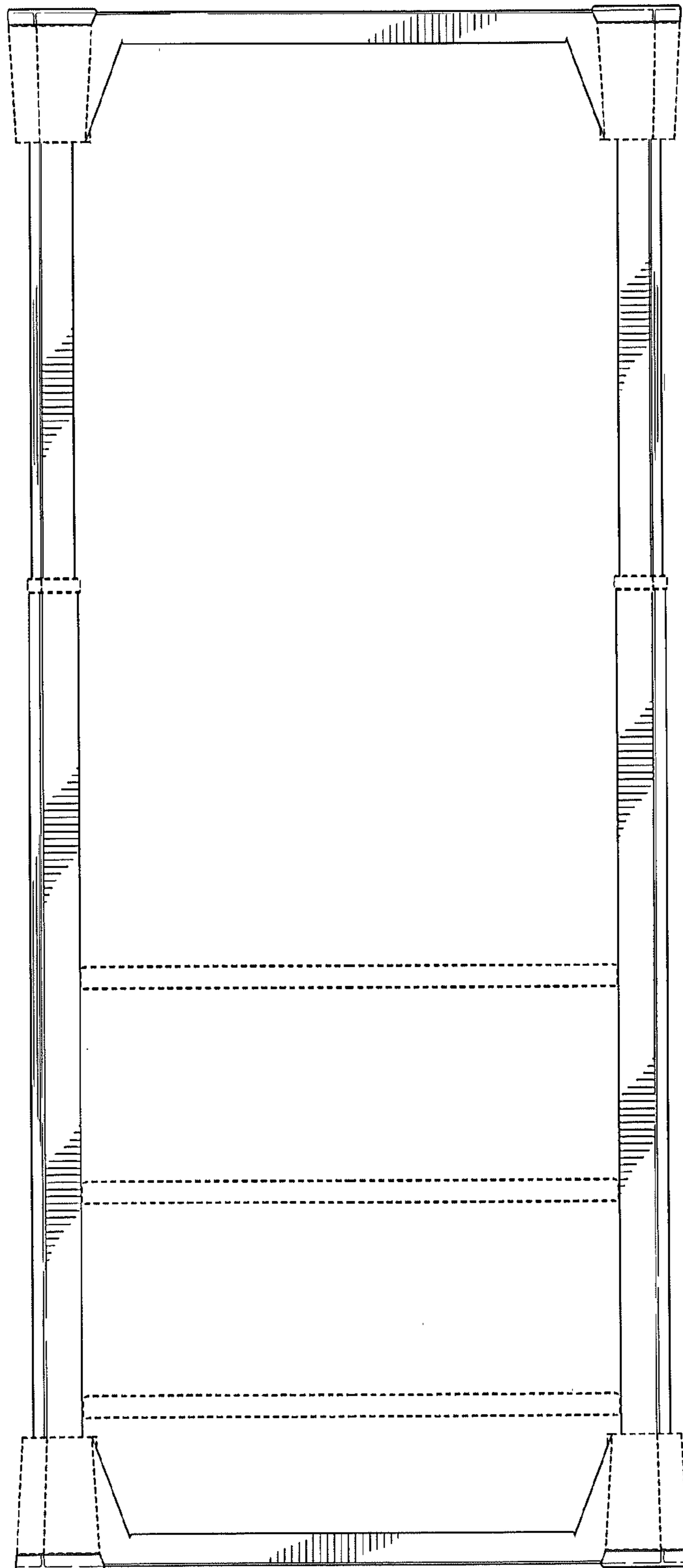

FIG. 25

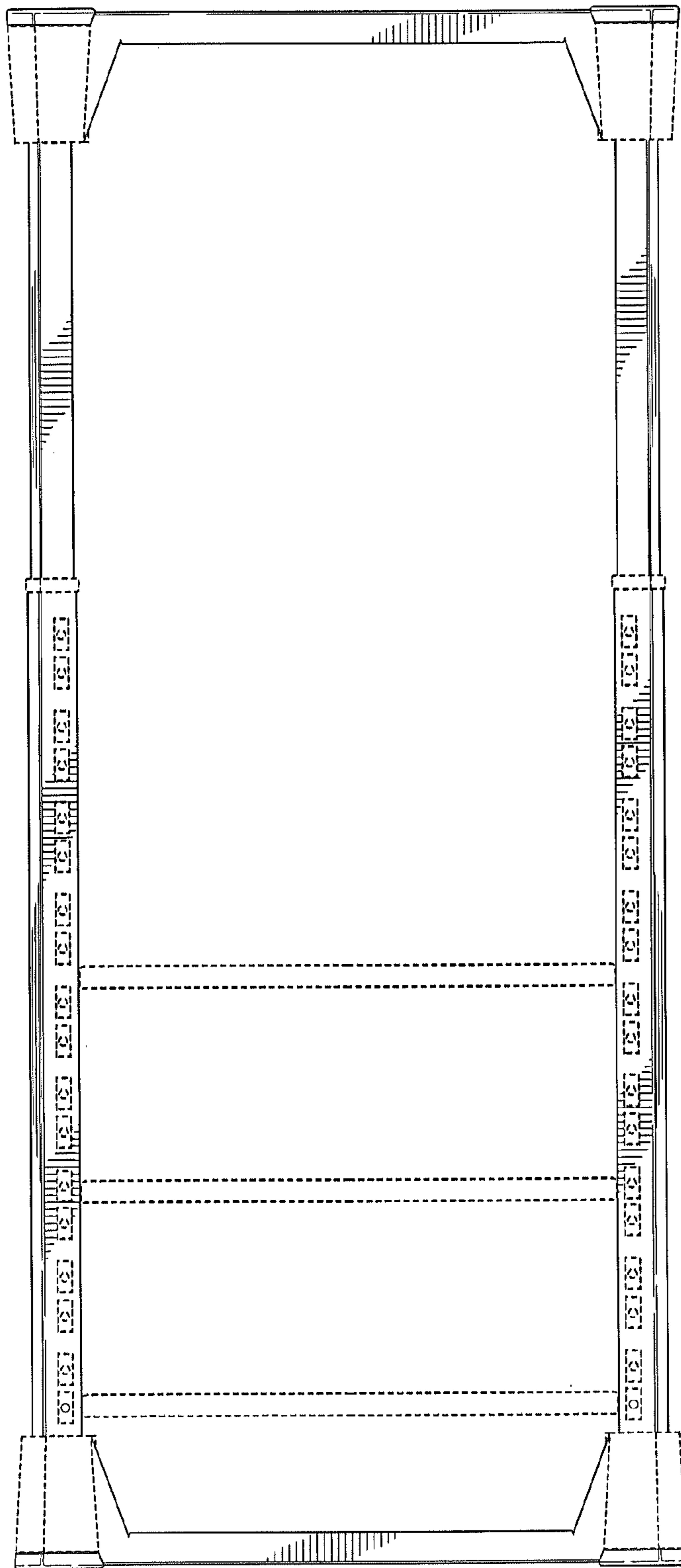

FIG. 26

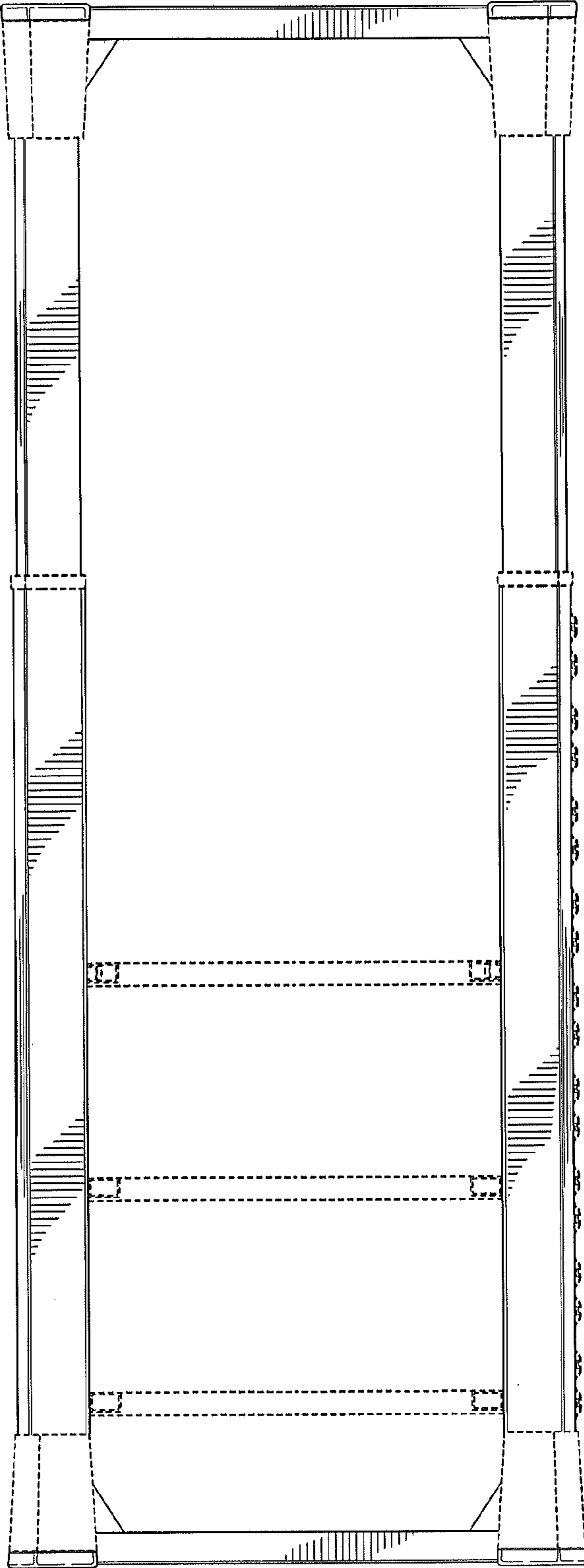

FIG. 27

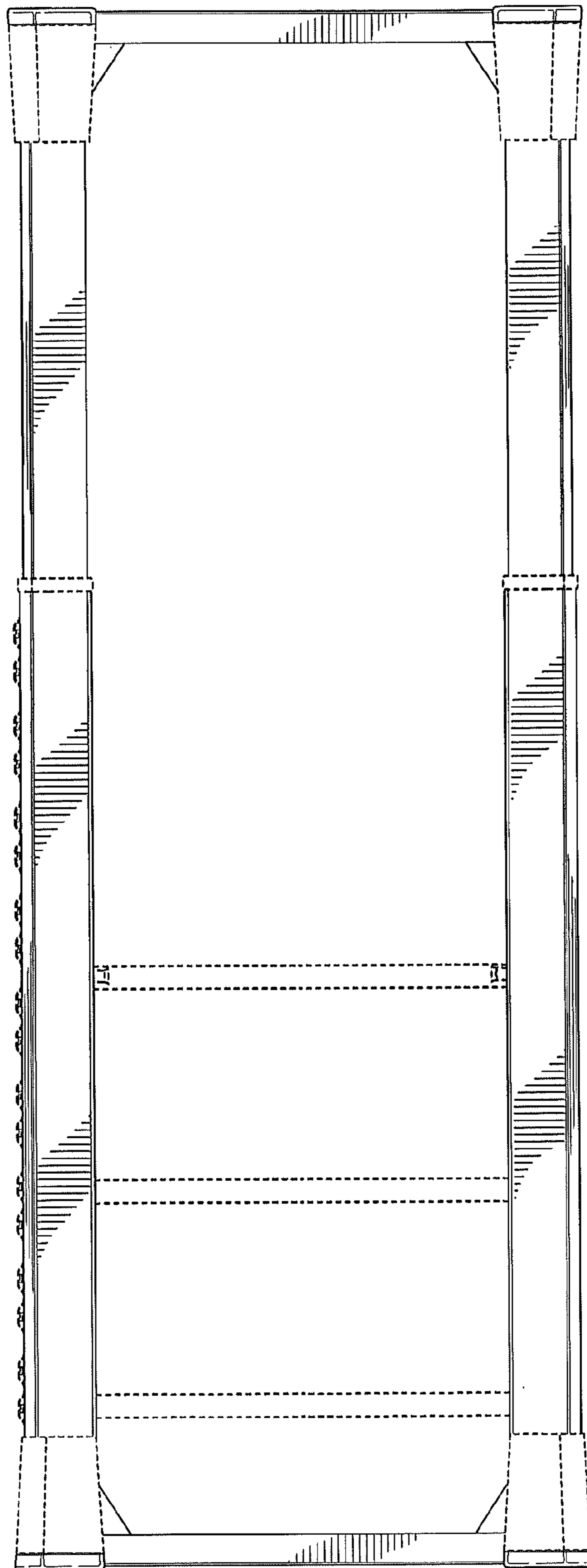

FIG. 28

UNITED STATES PATENT AND TRADEMARK OFFICE  
**CERTIFICATE OF CORRECTION**

PATENT NO. : D723,308 S  
APPLICATION NO. : 29/498845  
DATED : March 3, 2015  
INVENTOR(S) : Franck et al.

Page 1 of 1

It is certified that error appears in the above-identified patent and that said Letters Patent is hereby corrected as shown below:

On Title Page:

Item (71), Applicant:

Please correct "WirePath Home Systems, LLC, Charlotte, NC (US)"  
to read -- WirePath Home Systems, LLC d/b/a SnapAV, Charlotte, NC (US) --

Item (73), Assignee:

Please correct "WirePath Home Systems, LLC, Charlotte, NC (US)"  
to read -- WirePath Home Systems, LLC d/b/a SnapAV, Charlotte, NC (US) --

Signed and Sealed this  
Fourth Day of August, 2015



Michelle K. Lee  
*Director of the United States Patent and Trademark Office*