



US00D723266S

(12) **United States Design Patent**
Kinskey

(10) **Patent No.:** **US D723,266 S**
(45) **Date of Patent:** **** Mar. 3, 2015**

(54) **AIR GUN SUPPORT**

(71) Applicant: **LF Centennial Ltd.**, Road Town, Tortola (VG)

(72) Inventor: **Terrence P. Kinskey**, Alpharetta, GA (US)

(73) Assignee: **LF Centennial Ltd.**, Road Town, Tortola (VG)

(**) Term: **14 Years**

(21) Appl. No.: **29/482,775**

(22) Filed: **Feb. 21, 2014**

(51) **LOC (10) Cl.** **03-01**

(52) **U.S. Cl.**
USPC **D3/228**

(58) **Field of Classification Search**
USPC D3/228, 215, 218, 224, 226; 224/232, 224/240, 255, 259, 269, 665, 675, 677, 682, 224/901.4, 627, 250, 683, 674, 681, 684
See application file for complete search history.

(56) **References Cited**

U.S. PATENT DOCUMENTS

D213,451 S * 3/1969 White D3/228
D316,186 S * 4/1991 Seber D3/228

6,016,944 A * 1/2000 Girbert 224/646
D431,104 S * 9/2000 Dancyger D3/228
6,119,909 A * 9/2000 Dancyger 224/683
D433,228 S * 11/2000 Wentling, Jr. D3/226
6,390,348 B1 * 5/2002 Godshaw et al. 224/674
6,848,605 B2 * 2/2005 Dillenberger 224/670

* cited by examiner

Primary Examiner — Catheri Oliver-Garcia

(74) *Attorney, Agent, or Firm* — Duane Morris LLP; J. Rodman Steele, Jr.; Gregory M. Lefkowitz

(57) **CLAIM**

The ornamental design for an air gun support, as shown and described.

DESCRIPTION

FIG. 1 is a front, perspective view of my ornamental design; FIG. 2 is a front view of the ornamental design of FIG. 1; FIG. 3 is a left side view of the ornamental design of FIG. 1; FIG. 4 is a right side view of the ornamental design of FIG. 1; FIG. 5 is a top view of the ornamental design of FIG. 1; FIG. 6 is a bottom view of the ornamental design of FIG. 1; and,

FIG. 7 is a perspective, environmental view of the ornamental design of FIG. 1.

The broken lines are included for purposes of illustrating environment and form no part of the claimed design.

1 Claim, 6 Drawing Sheets

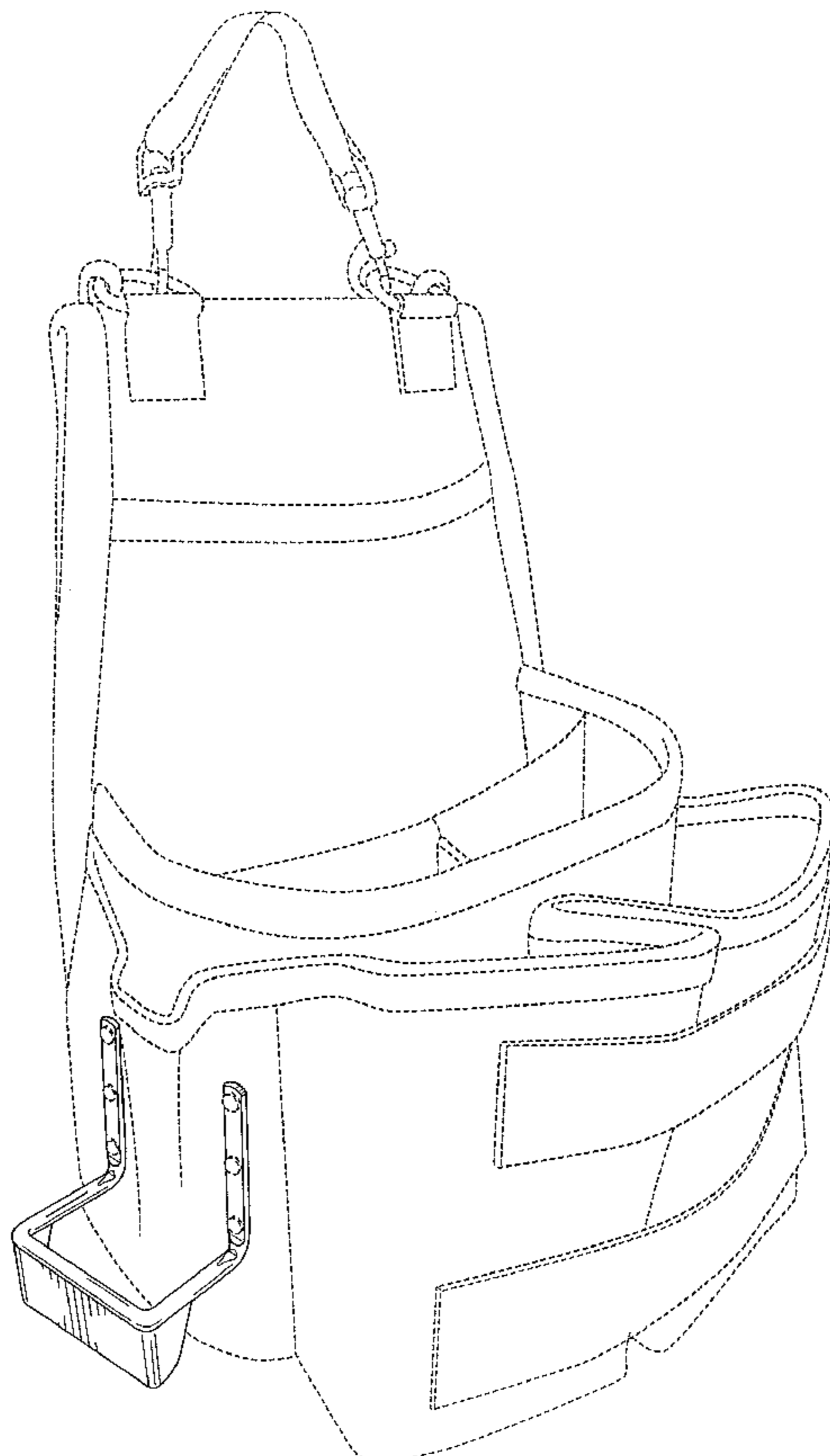

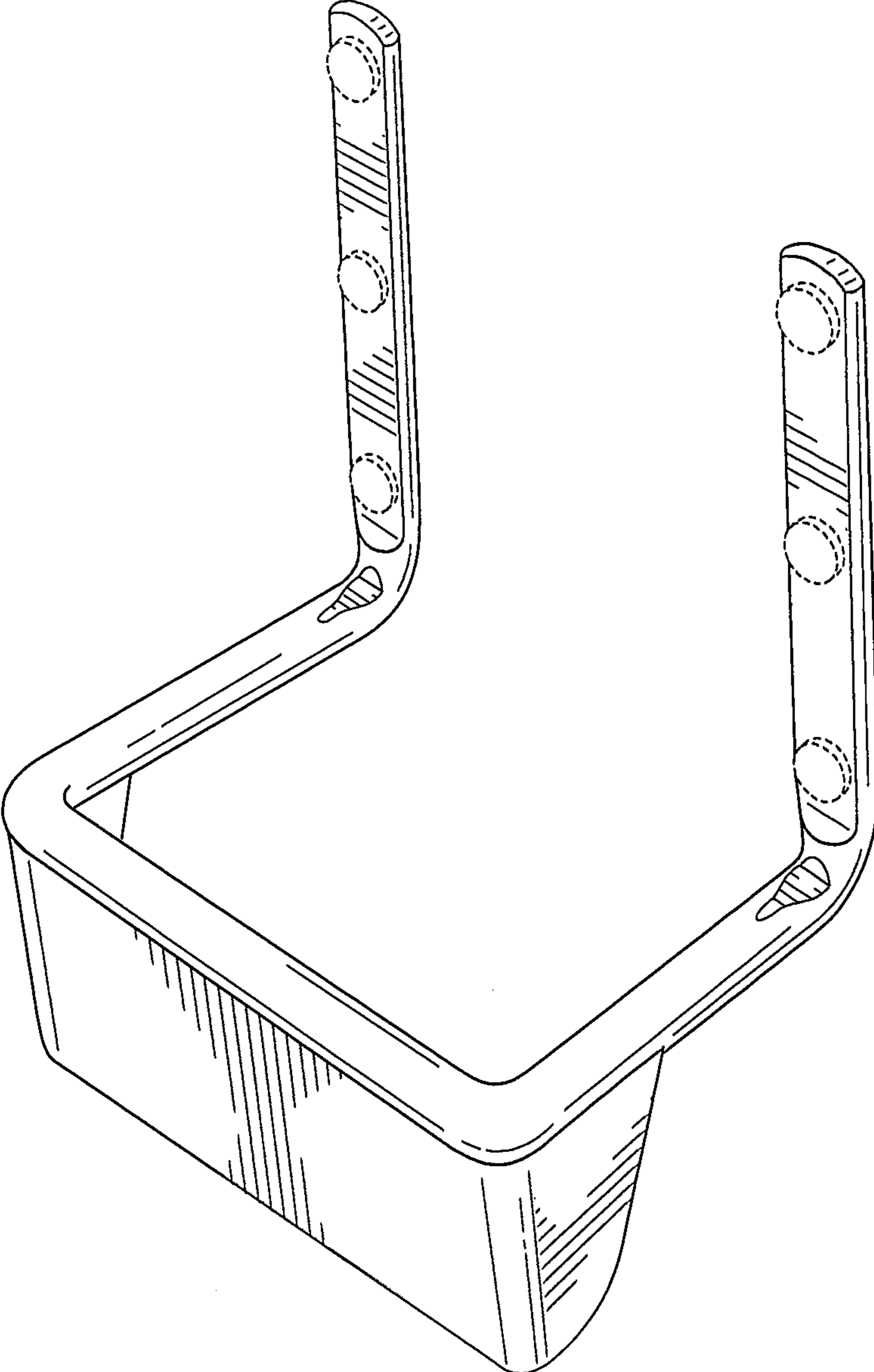

FIG. 1

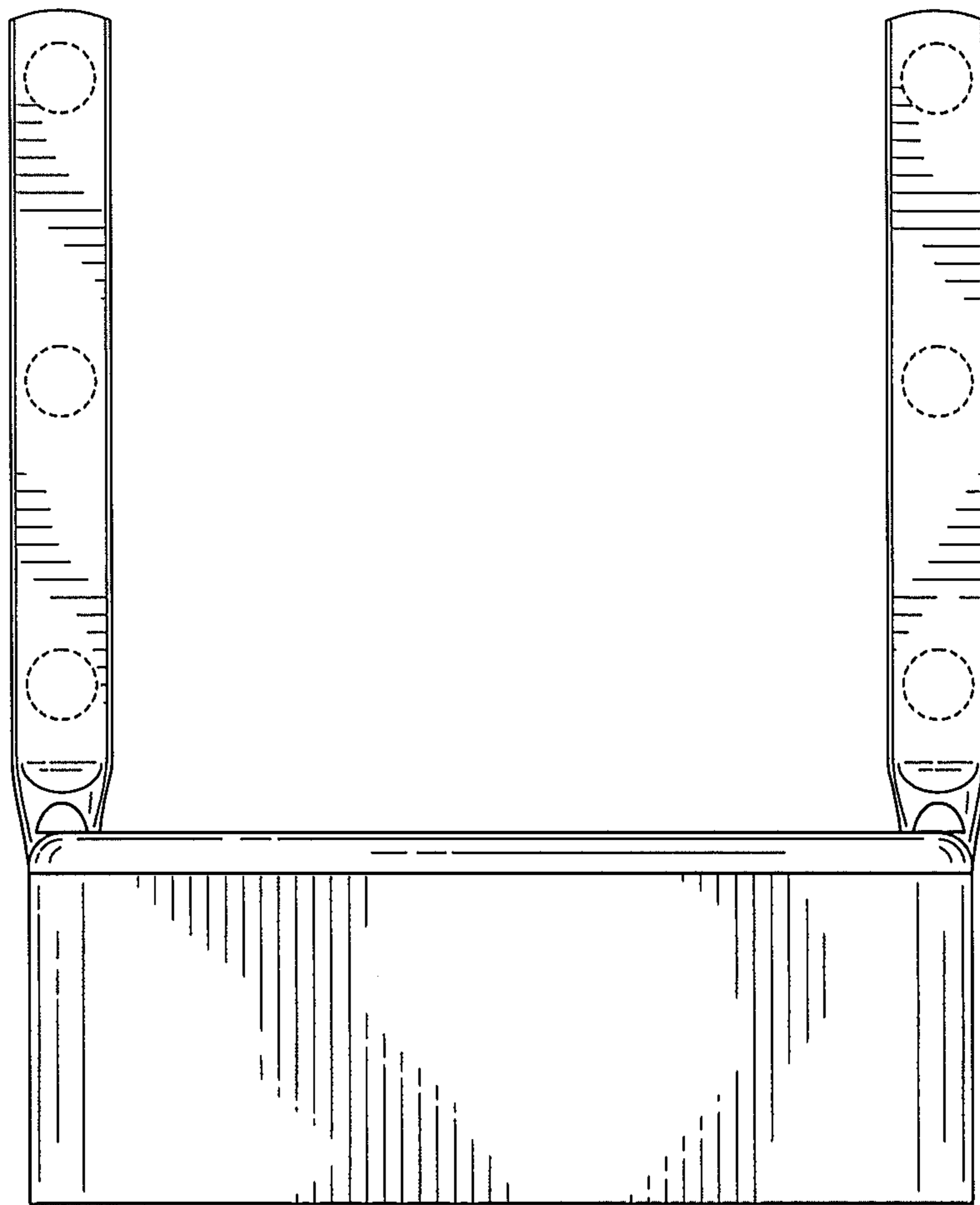

FIG. 2

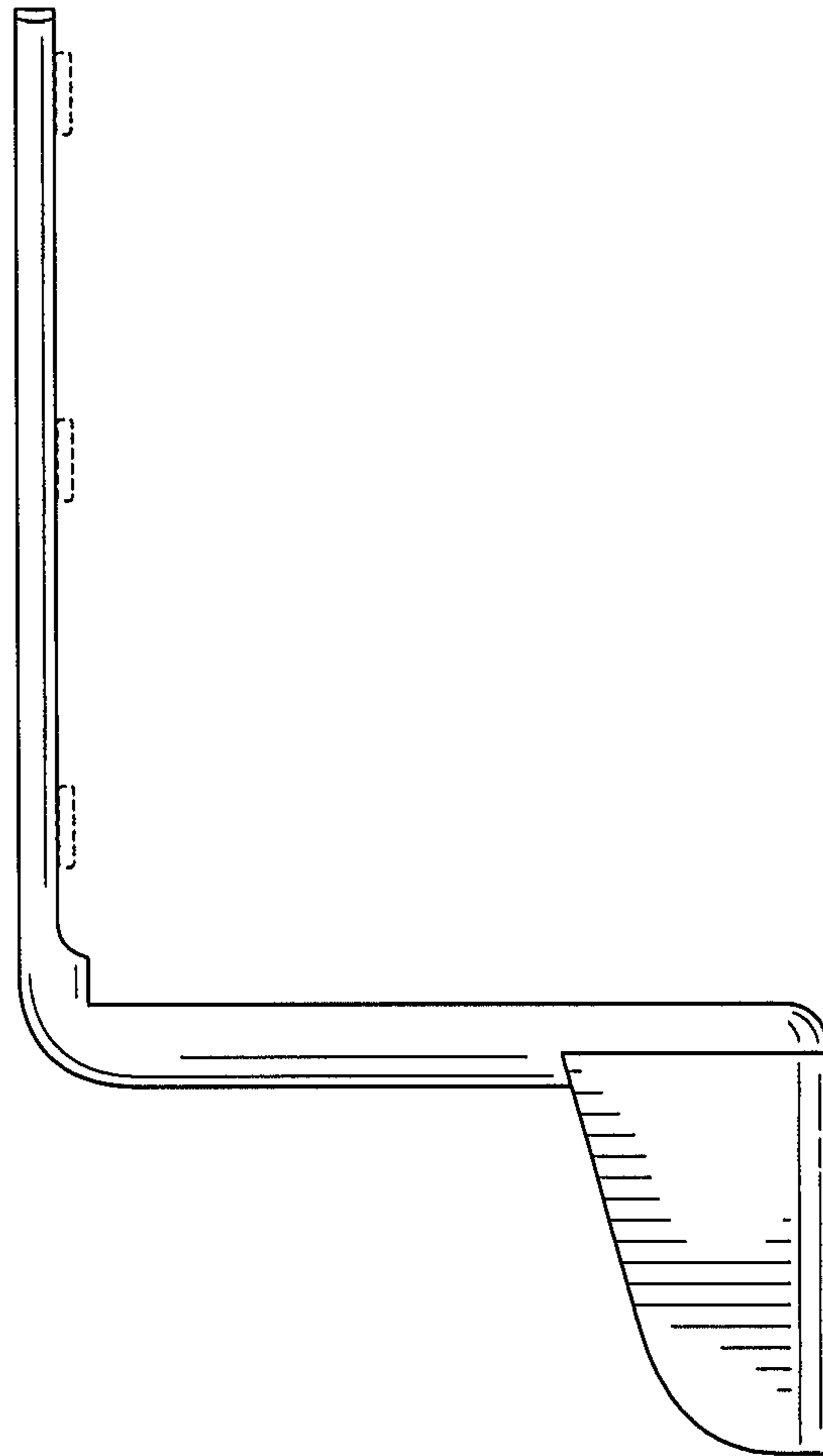

FIG. 3

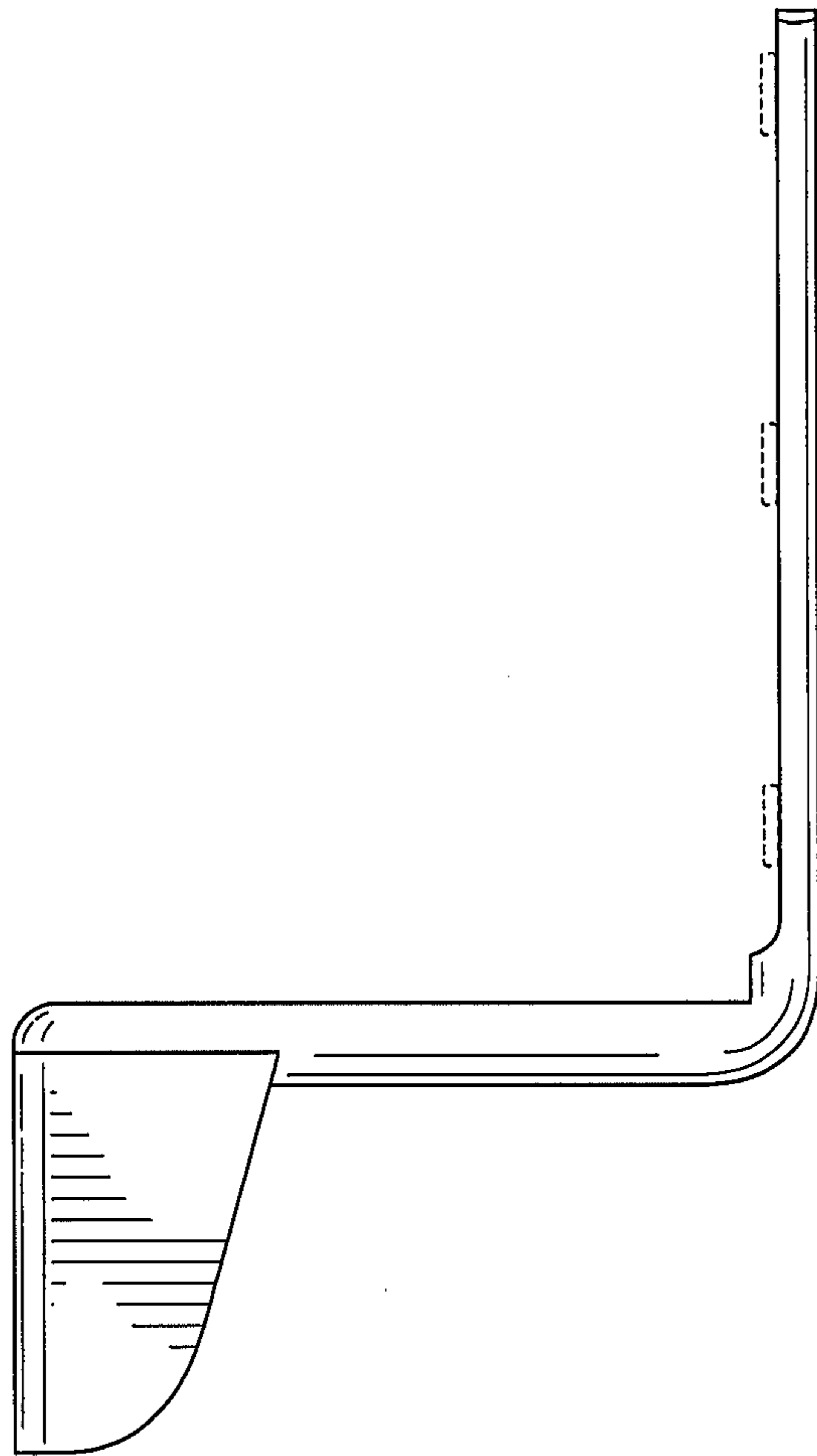

FIG. 4

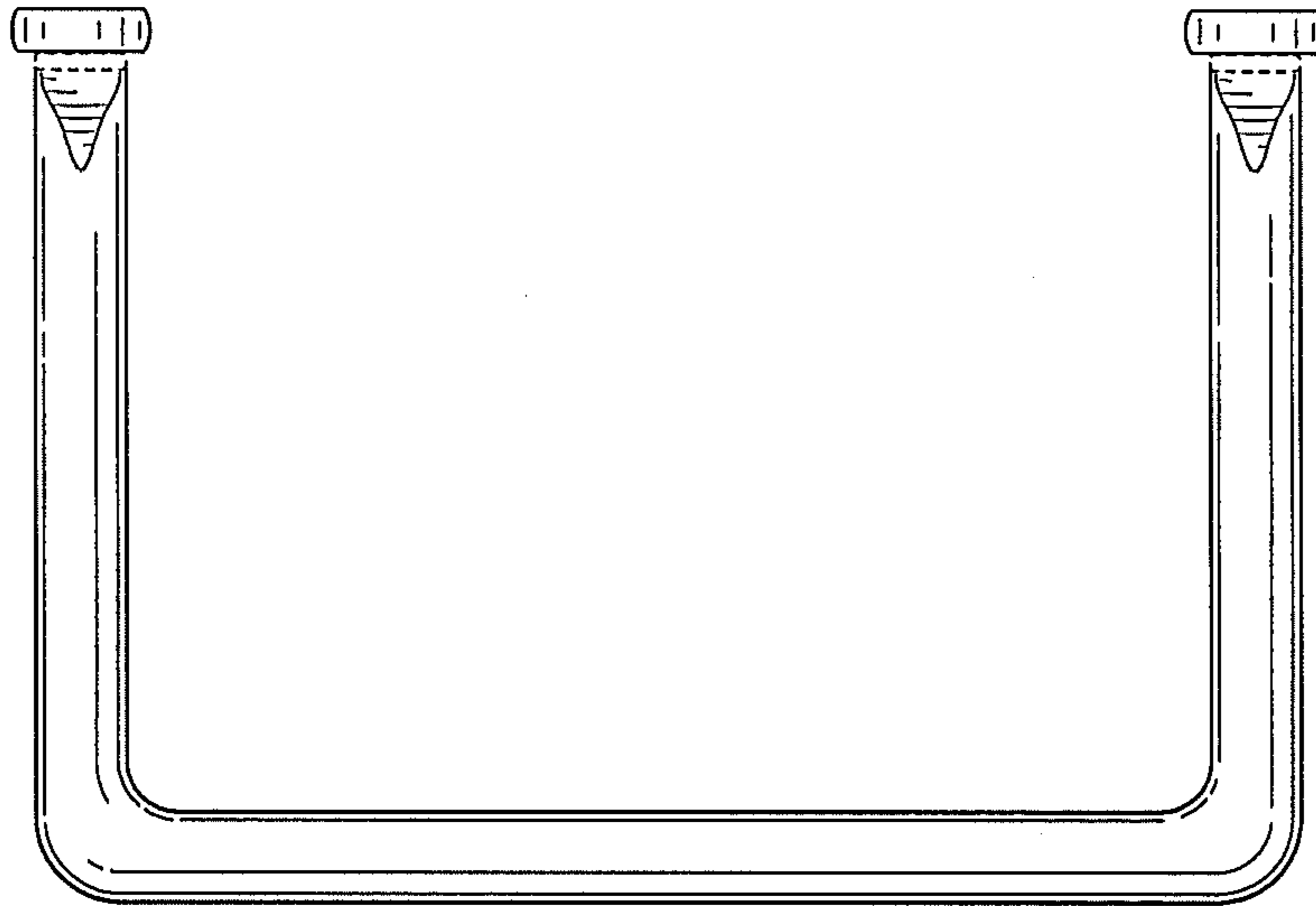

FIG. 5

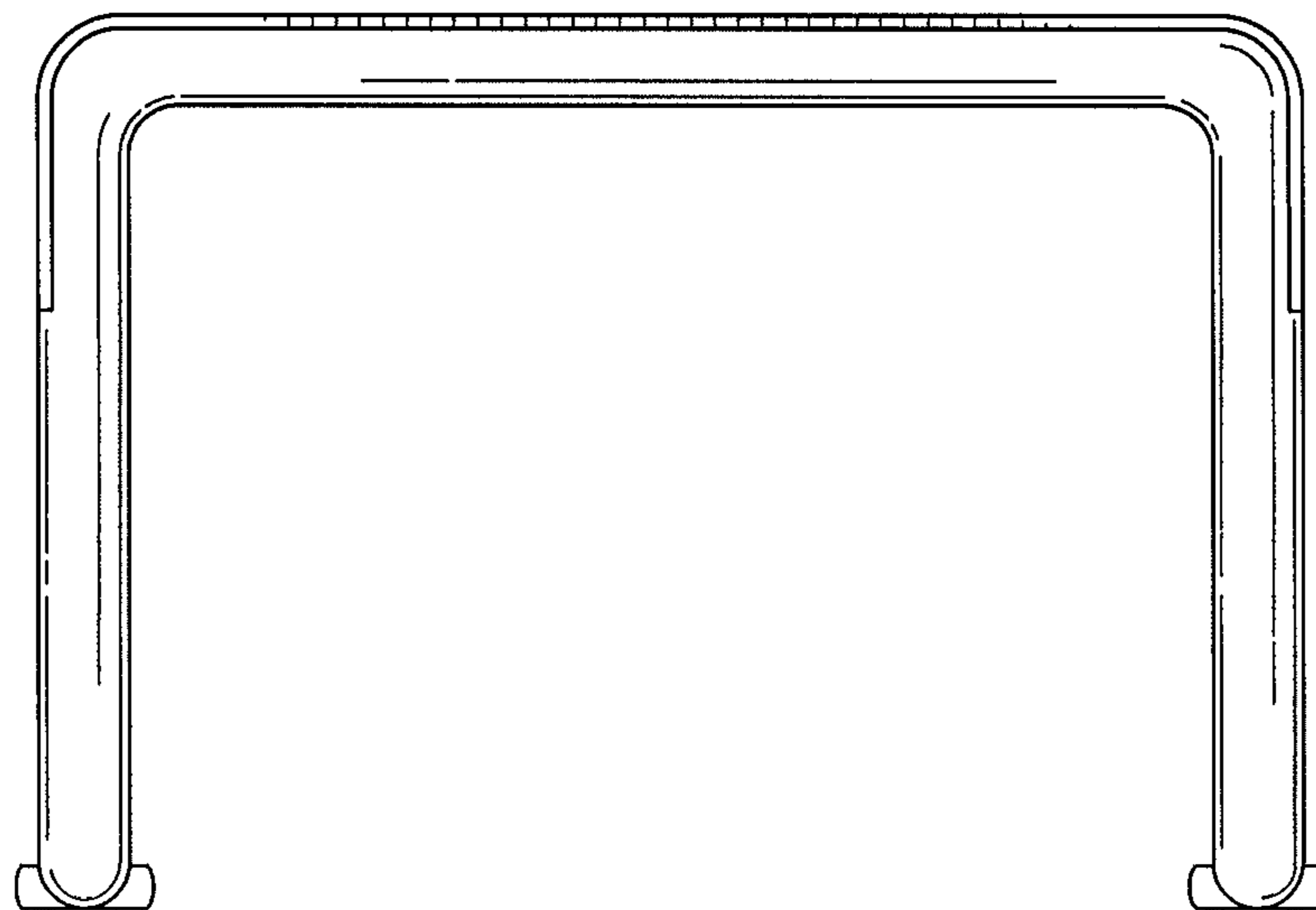

FIG. 6

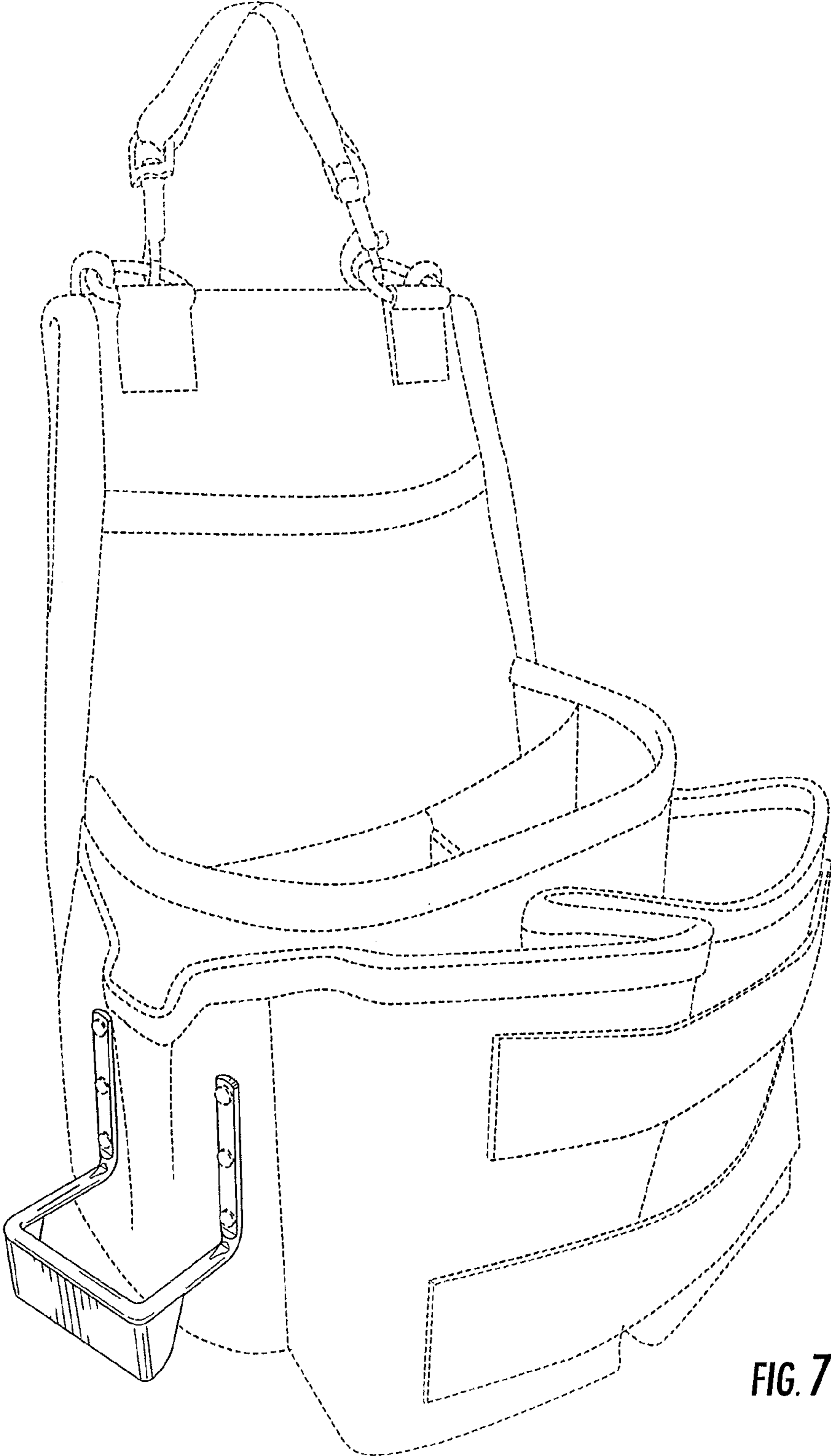

FIG. 7