



US00D723239S

(12) **United States Design Patent**
Raschke et al.

(10) **Patent No.:** **US D723,239 S**

(45) **Date of Patent:** **** Feb. 24, 2015**

(54) **WAFER CARRIER RING**

(75) Inventors: **Russ V. Raschke**, Chanhassen, MN (US); **Eric S. Olson**, Shorewood, MN (US); **Jason Todd Steffens**, Shakopee, MN (US)

(73) Assignee: **Entegris, Inc.**, Billerica, MA (US)

(**) Term: **14 Years**

(21) Appl. No.: **29/430,855**

(22) Filed: **Aug. 30, 2012**

(51) **LOC (10) Cl.** **12-05**

(52) **U.S. Cl.**
USPC **D34/29**

(58) **Field of Classification Search**
USPC D34/28, 29; 198/851, 853, 825, 890.1, 198/370.1, 370.04, 782, 722, 771, 866, 367, 198/790; 193/35 A, 35 C; 414/744.5, 800
See application file for complete search history.

(56) **References Cited**

U.S. PATENT DOCUMENTS

3,893,649	A *	7/1975	Cornell et al.	248/99
4,867,401	A *	9/1989	Graff	248/99
4,899,967	A *	2/1990	Johnson	248/97
D457,283	S *	5/2002	Wayt	D34/6
D591,924	S *	5/2009	Abe	D34/35
8,016,542	B2 *	9/2011	Cox et al.	414/744.5
D667,601	S *	9/2012	Fitzpatrick et al.	D34/6

2004/0048474	A1 *	3/2004	Asano	438/689
2006/0166503	A1 *	7/2006	Sasaki et al.	438/692
2012/0263569	A1 *	10/2012	Priddy et al.	414/800
2013/0330165	A1 *	12/2013	Wimplinger et al.	414/800
2014/0154038	A1 *	6/2014	Hudgens et al.	414/744.5

* cited by examiner

Primary Examiner — Cynthia Ramirez

(74) *Attorney, Agent, or Firm* — Christensen Fonder P.A.

(57) **CLAIM**

We claim the ornamental design for wafer carrier ring, as shown and described.

DESCRIPTION

FIG. 1 is a top perspective view of a wafer carrier ring according to an embodiment of the invention. The view from the opposite side being identical thereto.

FIG. 2 is a bottom perspective view of the wafer carrier ring depicted in FIG. 1. The view from the opposite side being identical thereto.

FIG. 3 is a top plan view of the wafer carrier ring.

FIG. 4 is a bottom plan view of the wafer carrier ring.

FIG. 5 is a front elevational view of the wafer carrier ring.

FIG. 6 is a side elevational view of the wafer carrier ring.

FIG. 7 is a cross sectional view taken at line 7-7 of FIG. 4.

FIG. 8 is a cross sectional view taken at line 8-8 of FIG. 4.

FIG. 9 is a top perspective view of the wafer carrier. The view from the opposite side being identical thereto; and,

FIG. 10 is a bottom perspective view of the wafer carrier ring. The view from the opposite side being identical thereto.

1 Claim, 8 Drawing Sheets

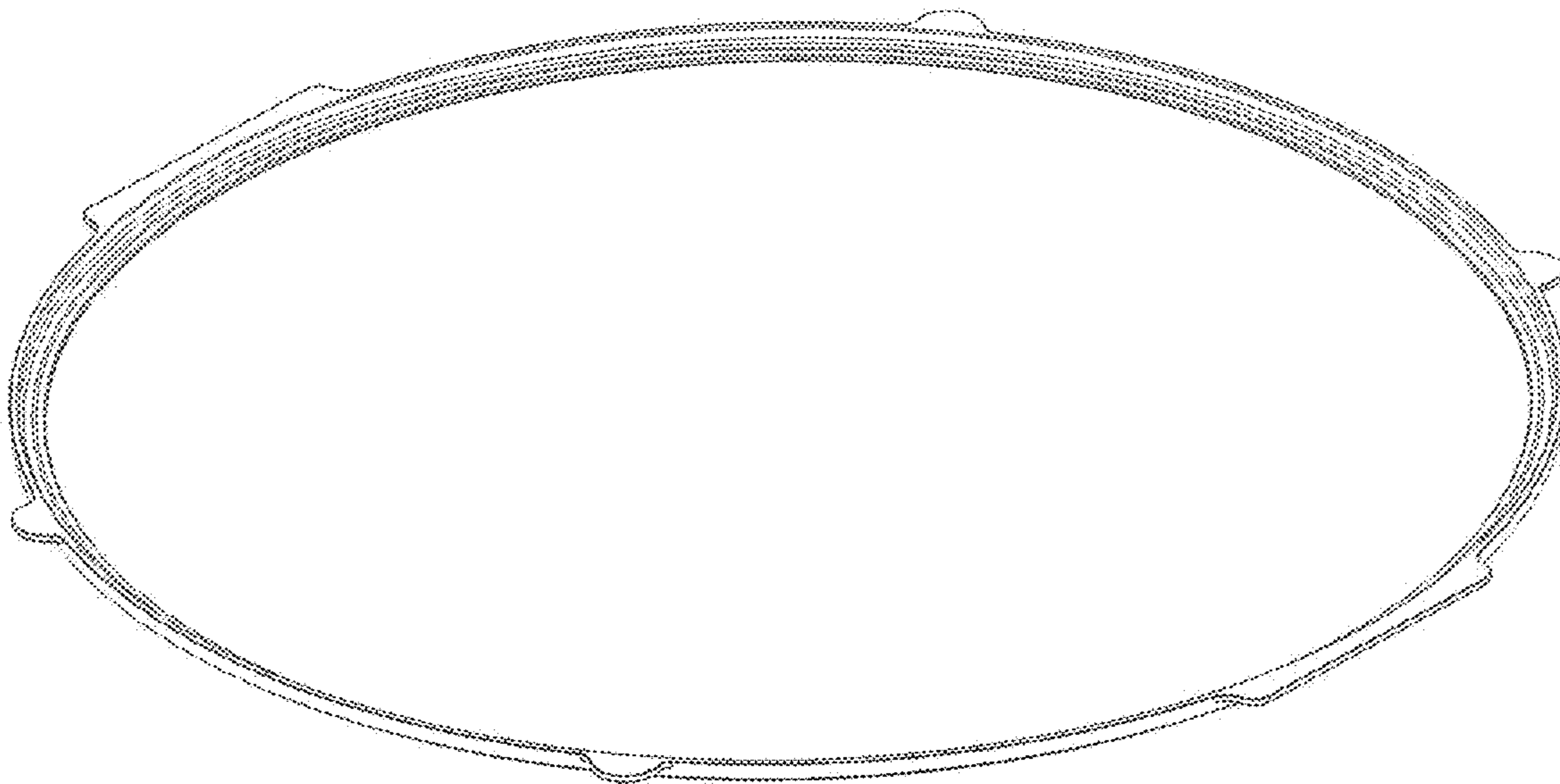

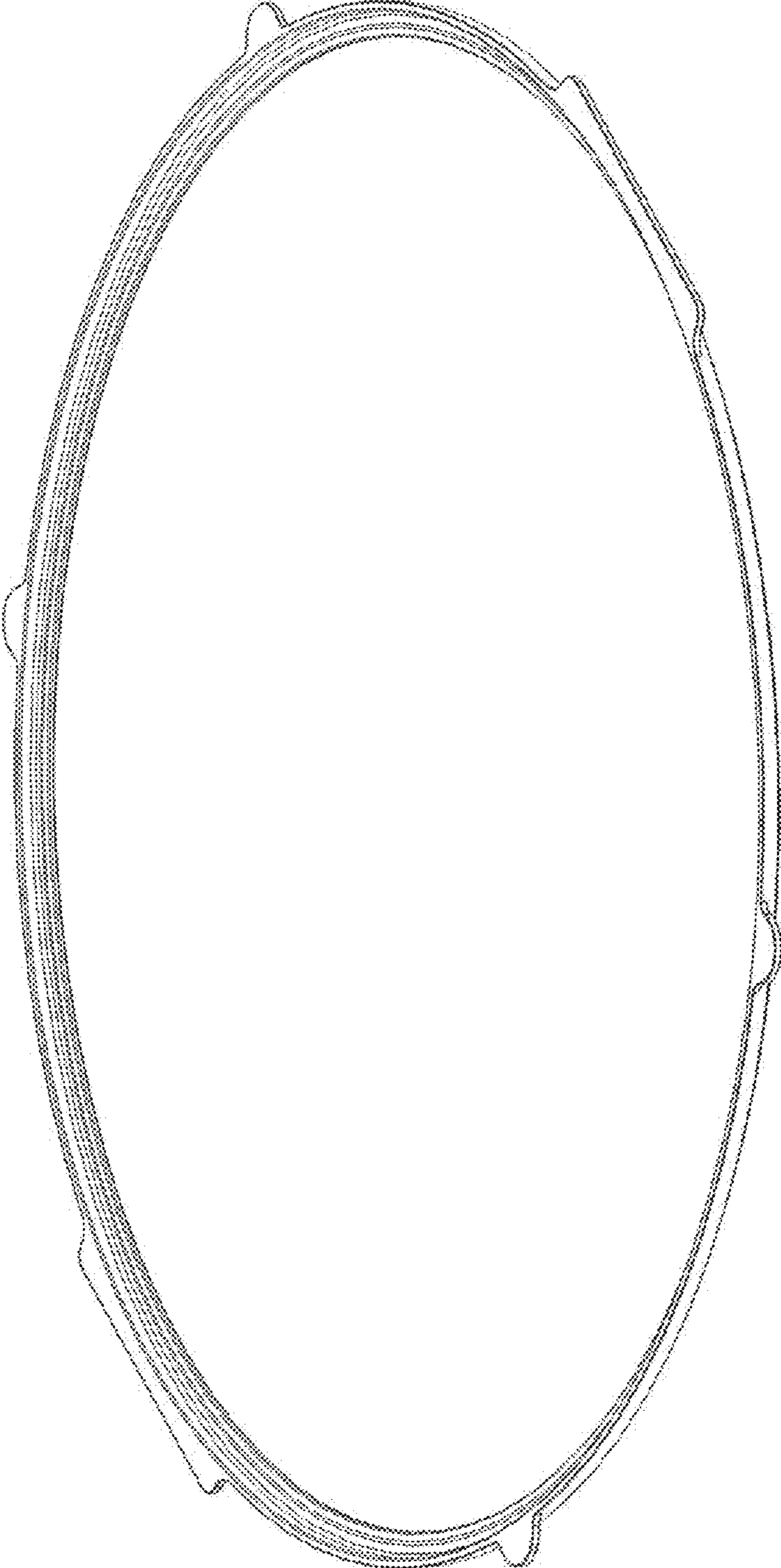

Fig. 1

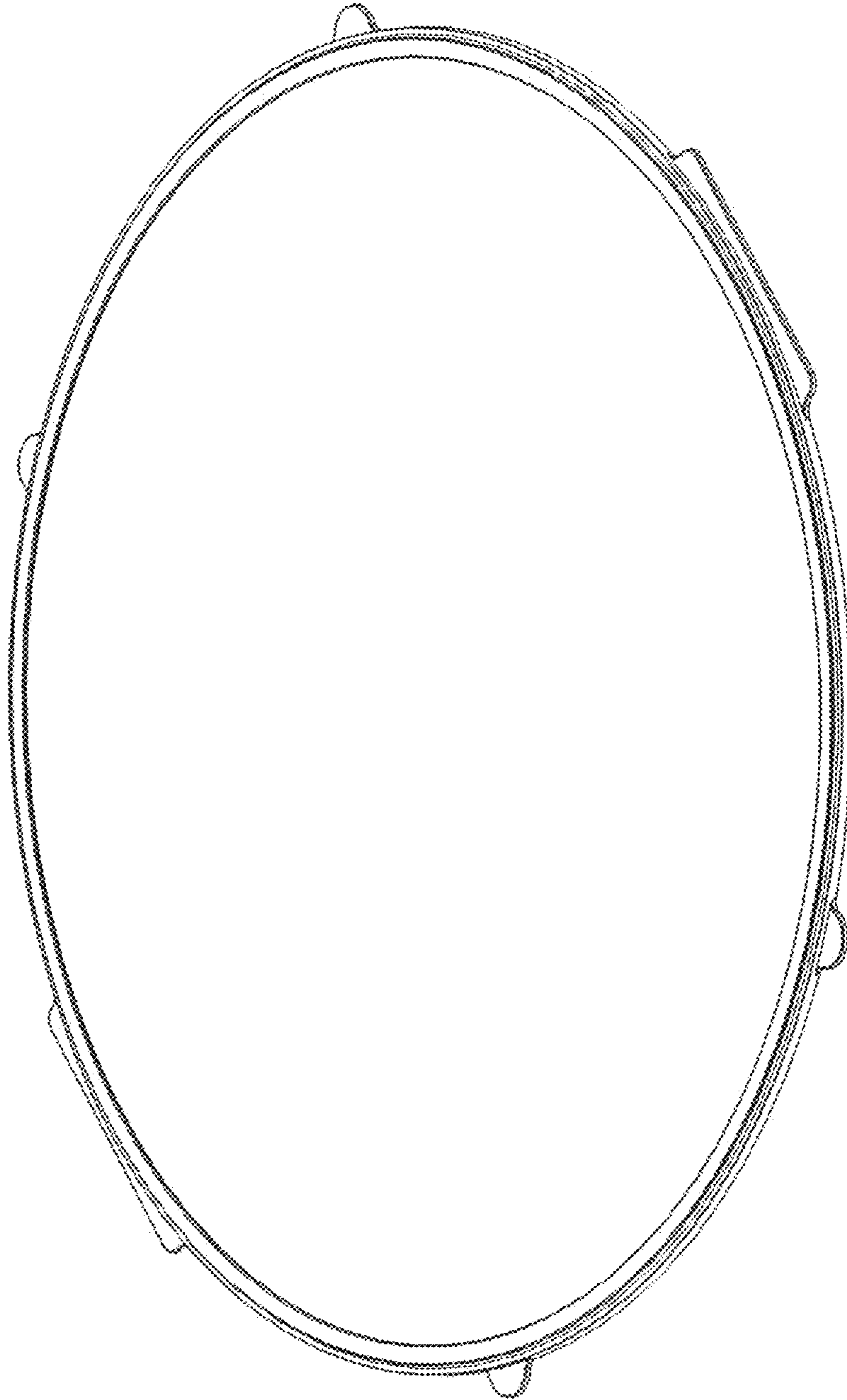

Fig. 2

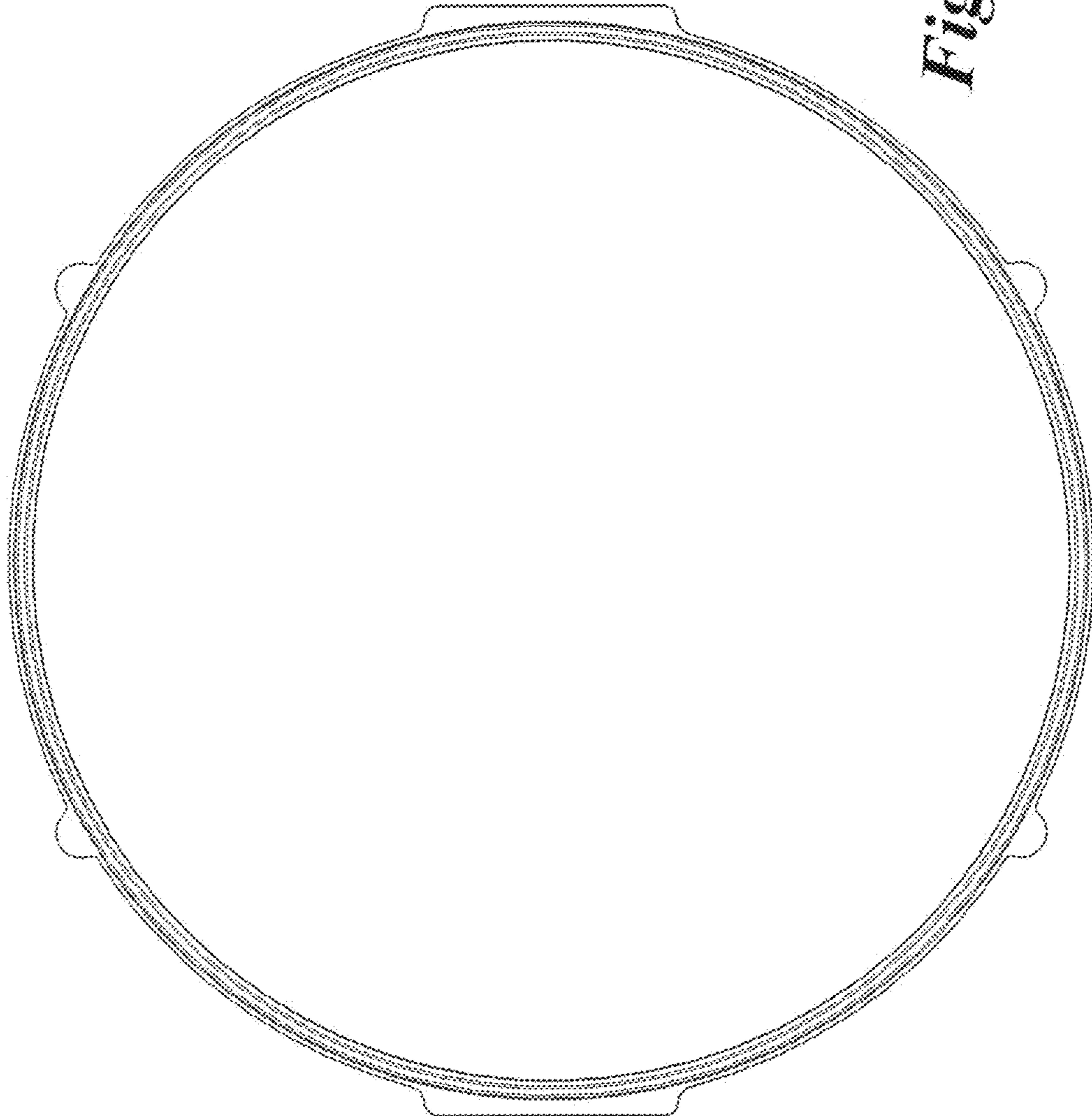

Fig. 3

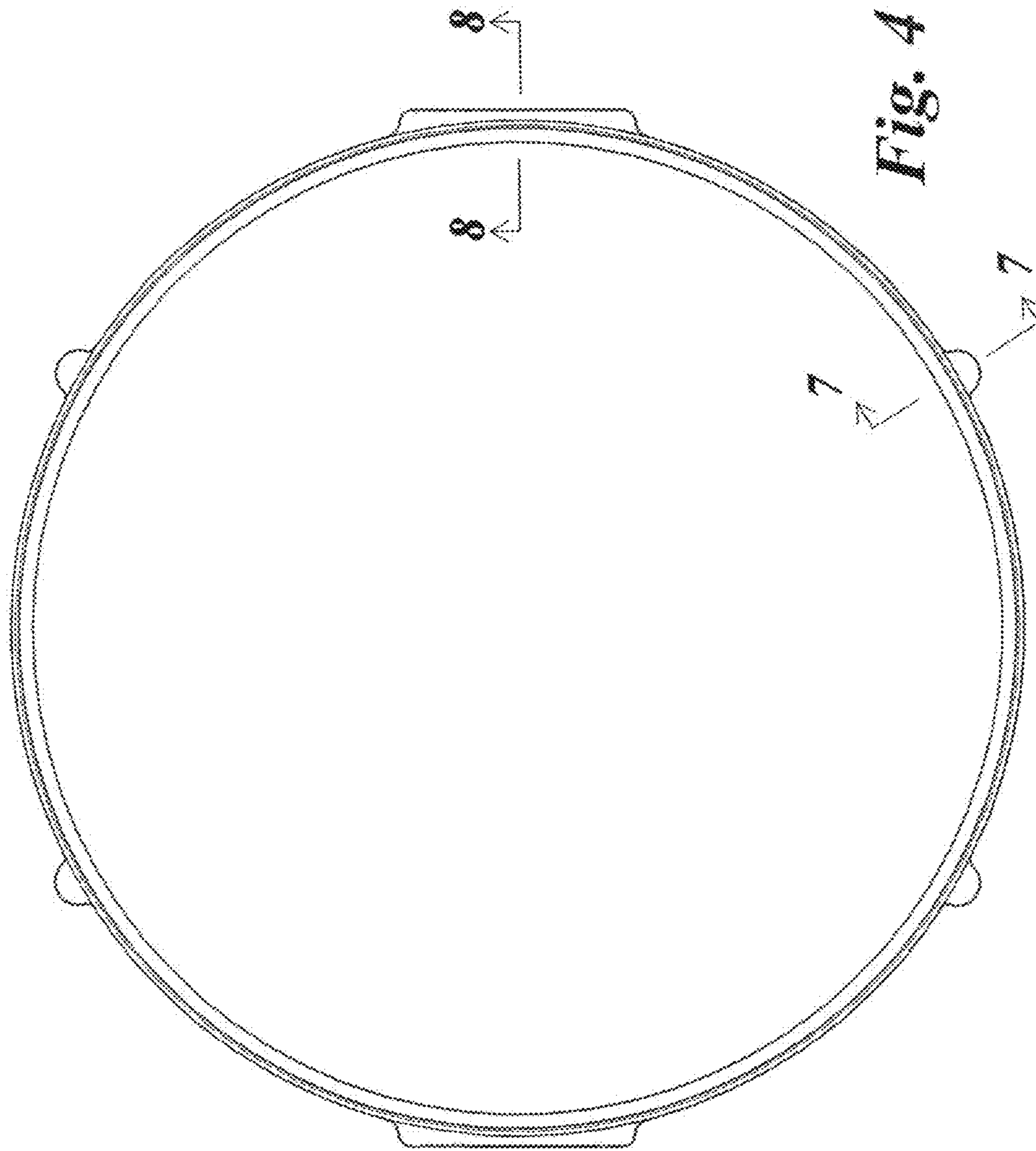

Fig. 4

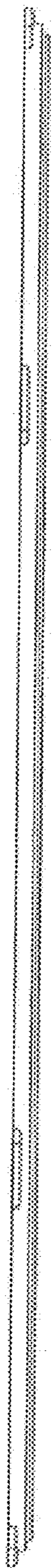

Fig. 5

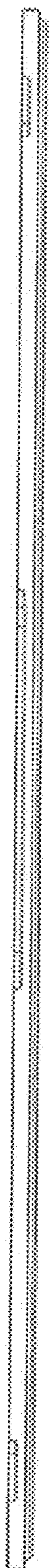

Fig. 6

Fig. 7

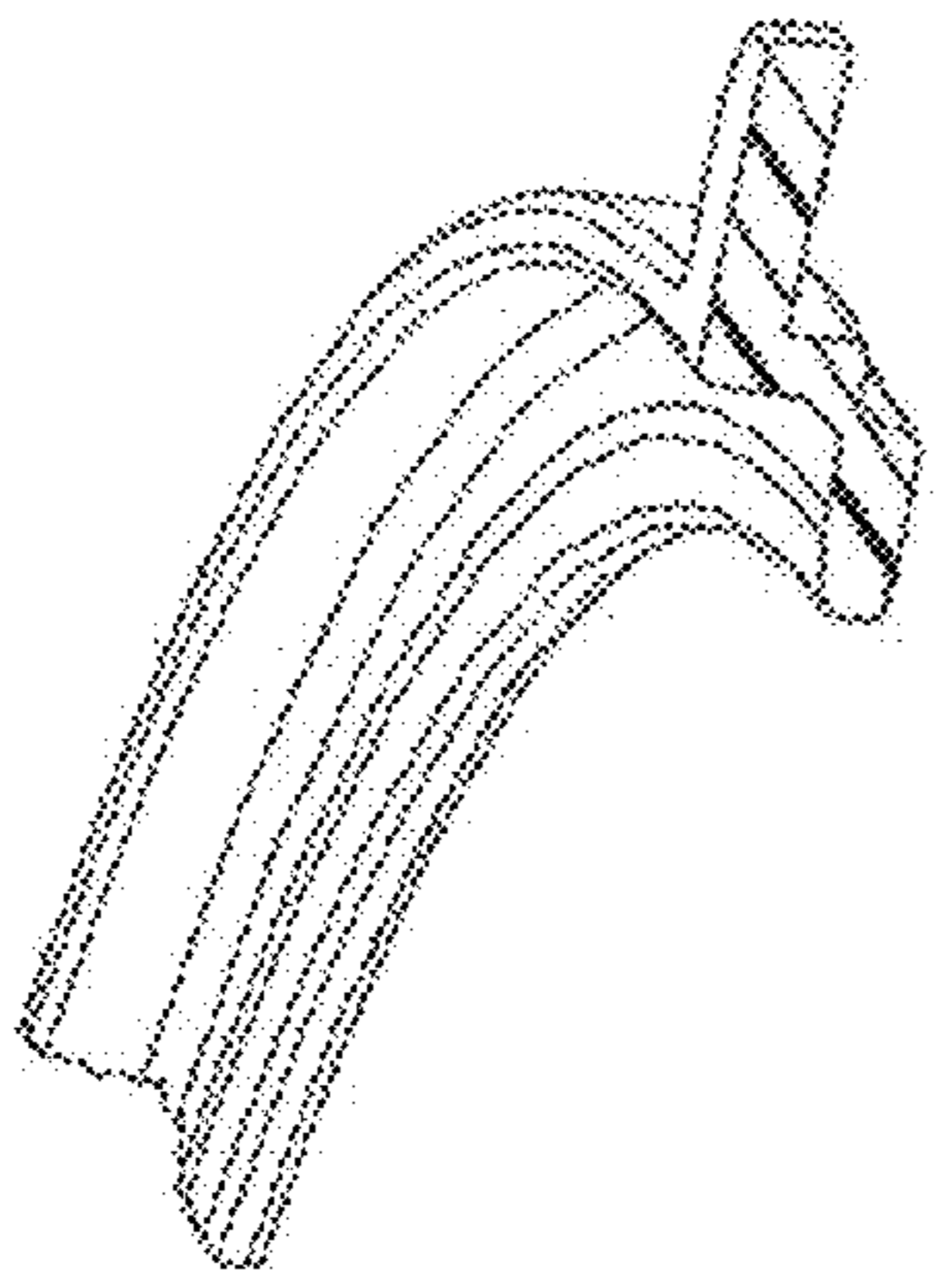
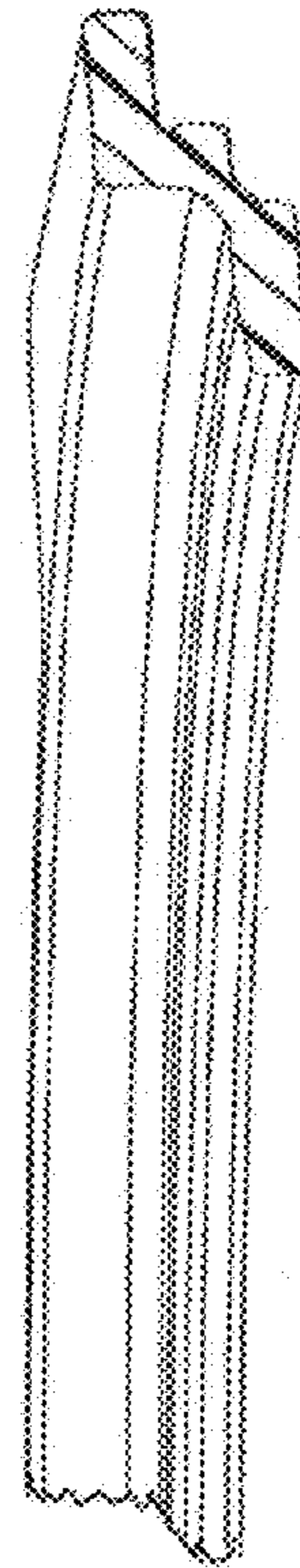

Fig. 8



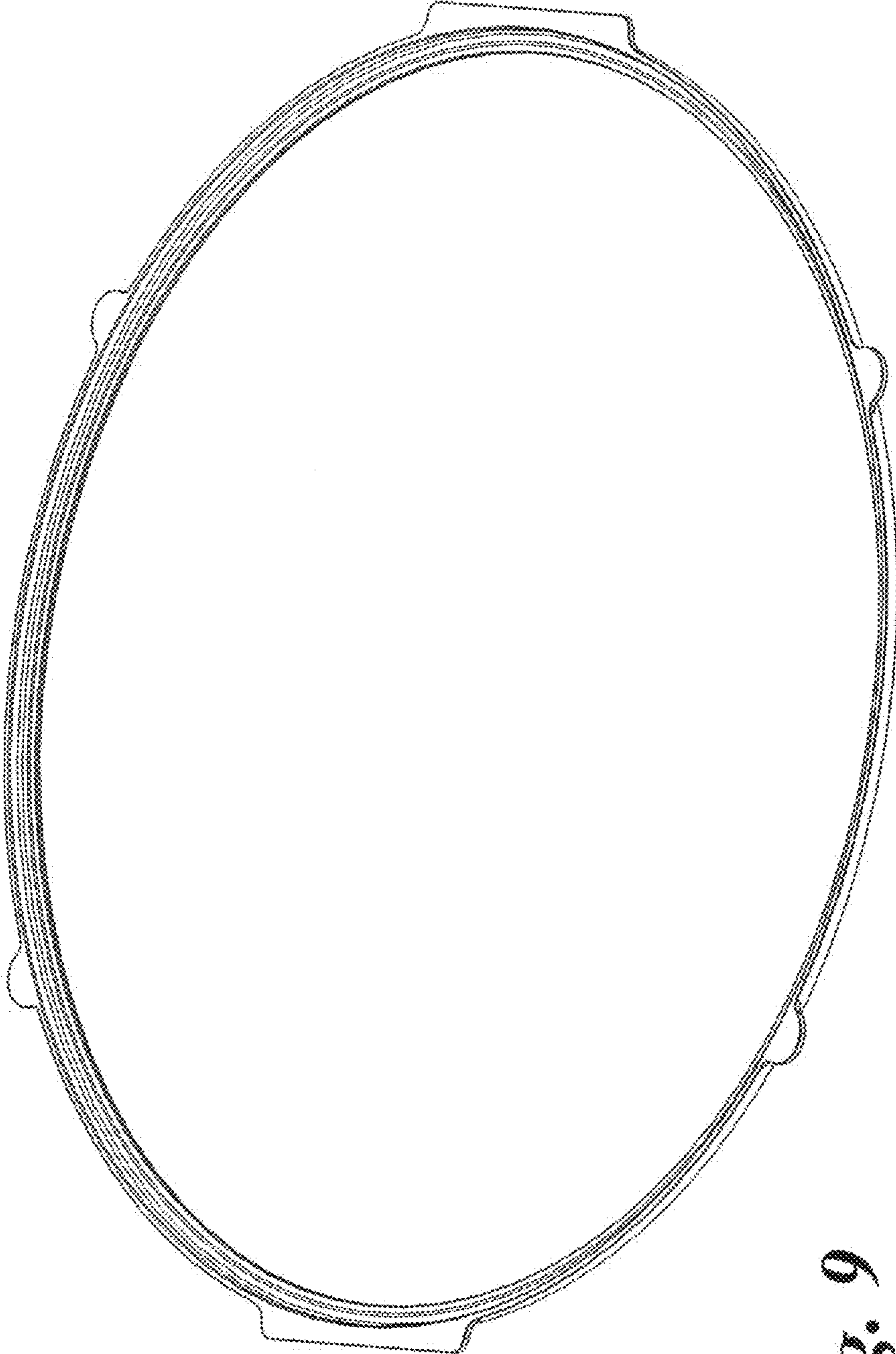

Fig. 9

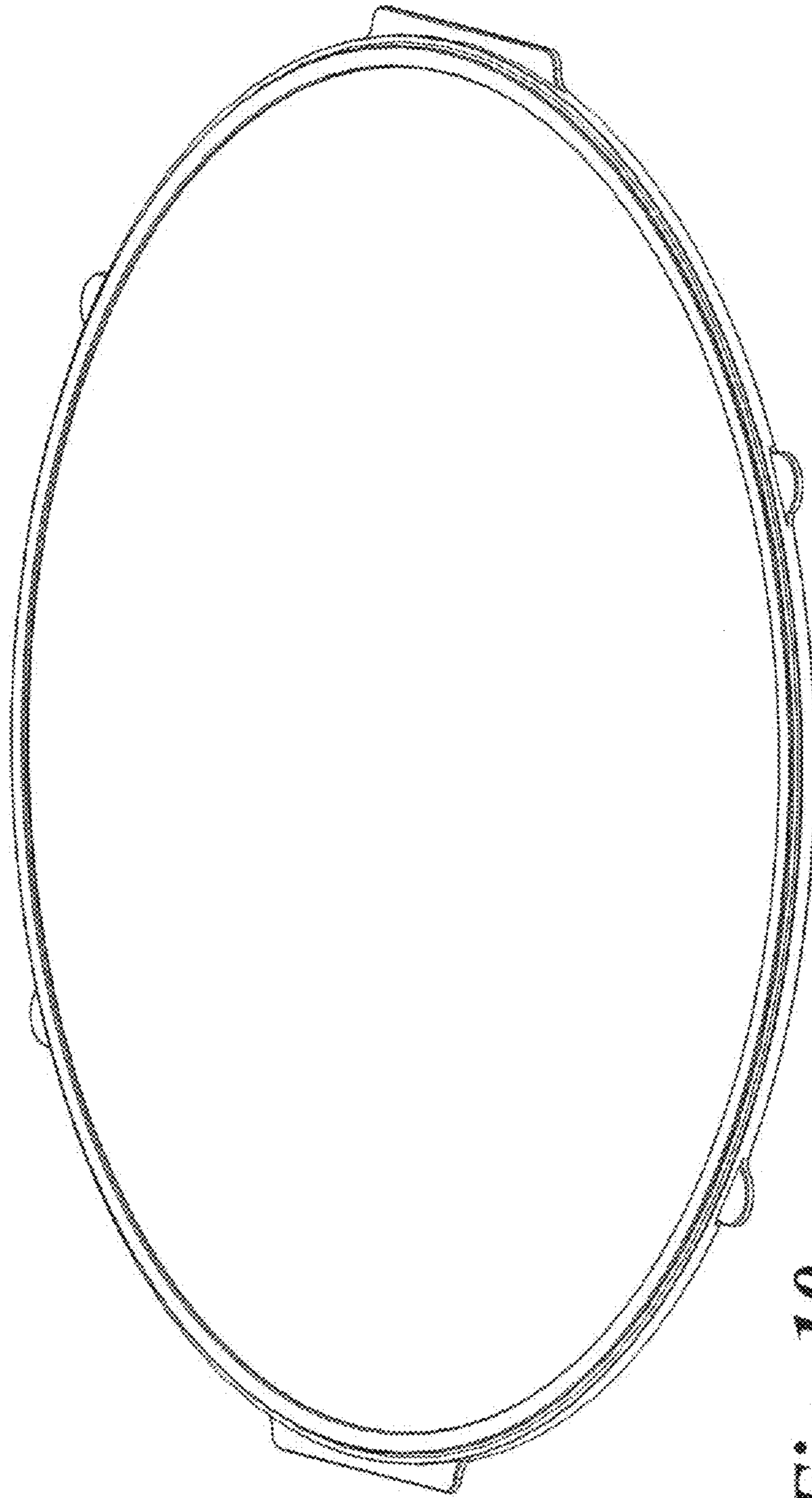

Fig. 10