



US00D723213S

(12) **United States Design Patent**
Campagna

(10) **Patent No.:** **US D723,213 S**

(45) **Date of Patent:** **** Feb. 24, 2015**

(54) **SOLAR POWERED LED FRAME AND LENS**

(71) Applicant: **Cary J. Campagna**, Portage, MI (US)

(72) Inventor: **Cary J. Campagna**, Portage, MI (US)

(73) Assignee: **Command Electronics, Inc.**,
Schoolcraft, MI (US)

(**) Term: **14 Years**

(21) Appl. No.: **29/453,740**

(22) Filed: **May 2, 2013**

(51) **LOC (10) Cl.** **26-99**

(52) **U.S. Cl.**

USPC **D26/139**

(58) **Field of Classification Search**

USPC D26/28-36, 139; 362/459-468,
362/475-478, 485-487

See application file for complete search history.

(56) **References Cited**

U.S. PATENT DOCUMENTS

D465,861 S *	11/2002	Huang	D26/28
D471,657 S *	3/2003	Huang	D26/28
D511,220 S *	11/2005	Lin	D26/28

* cited by examiner

Primary Examiner — Marcus Jackson

(74) *Attorney, Agent, or Firm* — Flynn, Thiel, Boutell & Tanis, P.C.

(57) **CLAIM**

The ornamental designs for a solar powered LED frame and lens, as shown and described.

DESCRIPTION

FIG. 1 is a front, right side and top isometric view of a solar powered LED frame and lens embodying my new design;
 FIG. 2 is a top view thereof;
 FIG. 3 is a front view thereof;
 FIG. 4 is a left side view thereof;
 FIG. 5 is a right side view thereof;
 FIG. 6 is a rear view thereof;
 FIG. 7 is a bottom view thereof;
 FIG. 8 is an exploded front, right side and top isometric view of the frame and lens shown separated;
 FIG. 9 is a top view of the lens;
 FIG. 10 is a front view of the lens;
 FIG. 11 is a left side view of the lens;
 FIG. 12 is a right side view of the lens;
 FIG. 13 is a rear view of the lens;
 FIG. 14 is a bottom view of the lens;
 FIG. 15 is a front, right side and top isometric view of the frame;
 FIG. 16 is a bottom view of the frame; and,
 FIG. 17 is a front, bottom and left side isometric view of the frame.

The broken lines shown represent unclaimed subject matter and form no part of the claimed design.

1 Claim, 10 Drawing Sheets

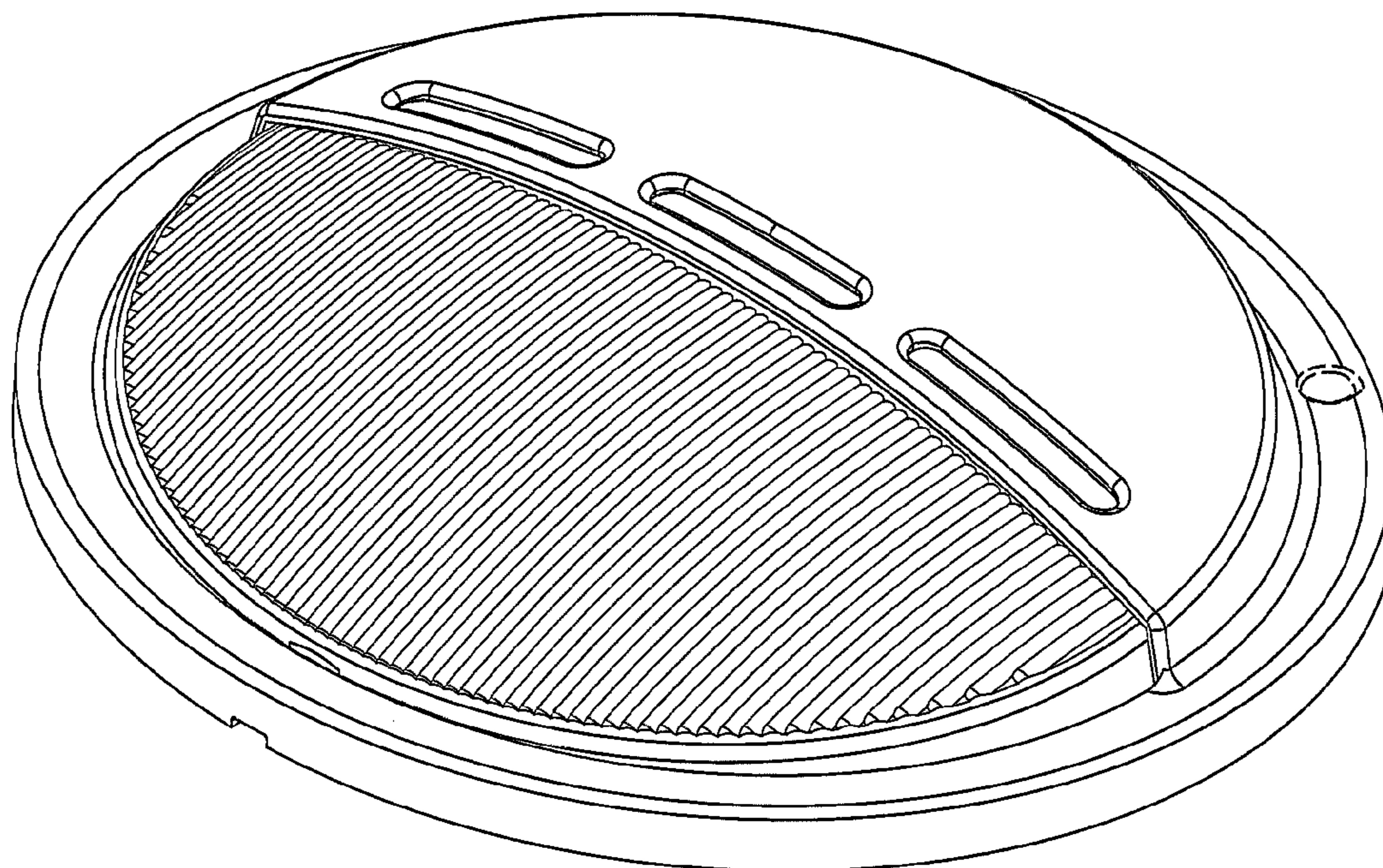

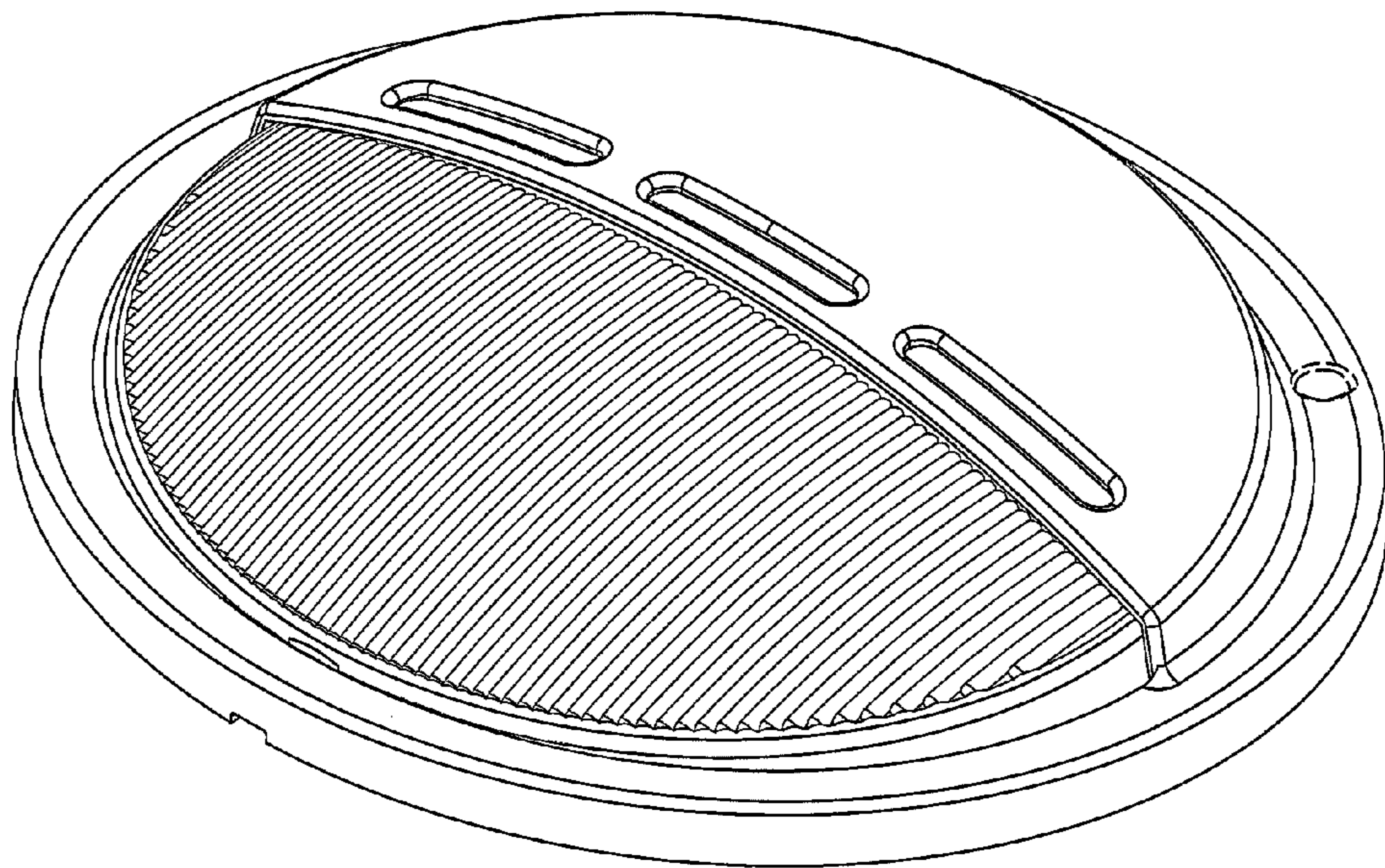

FIG. 1

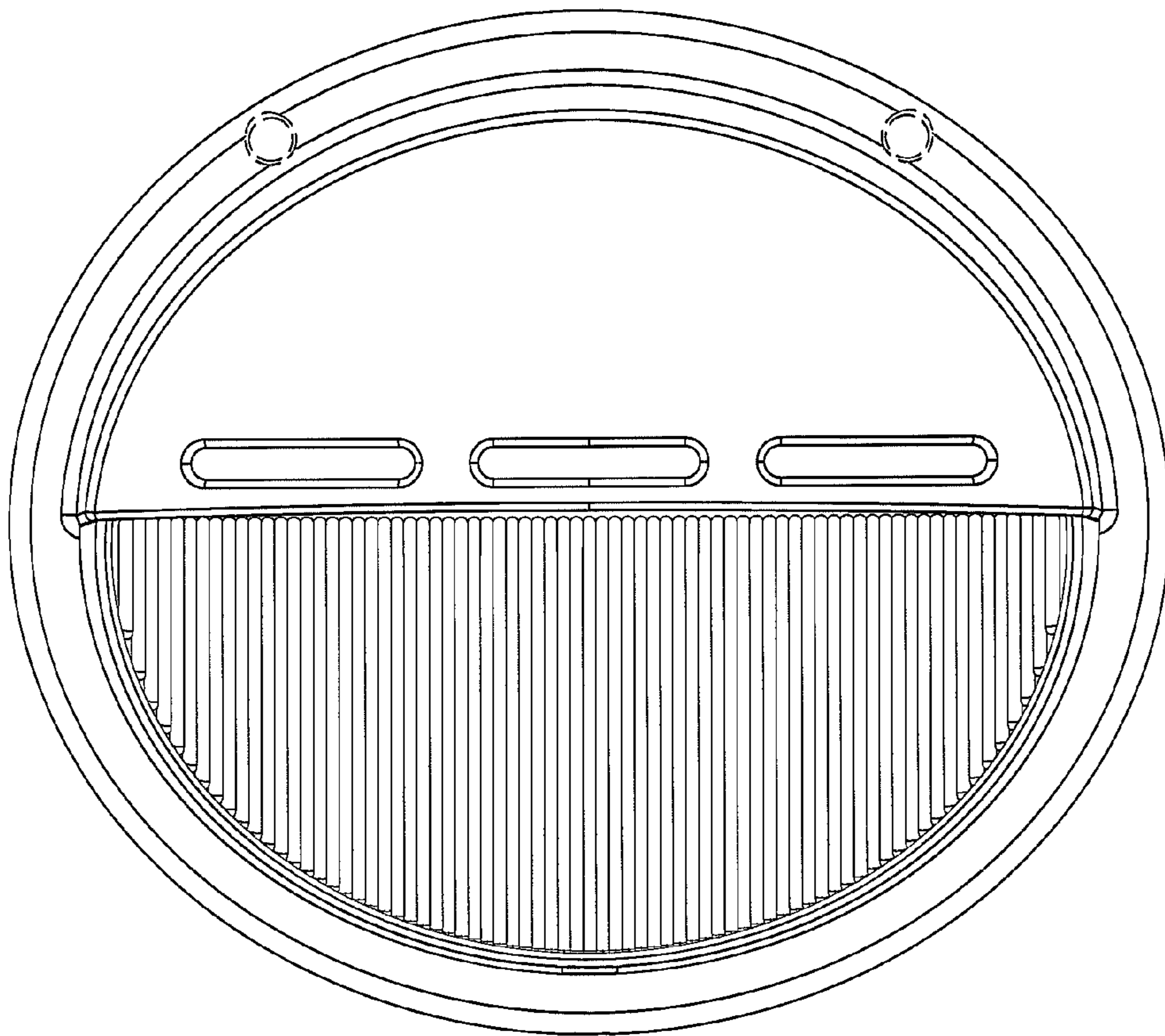

FIG. 2

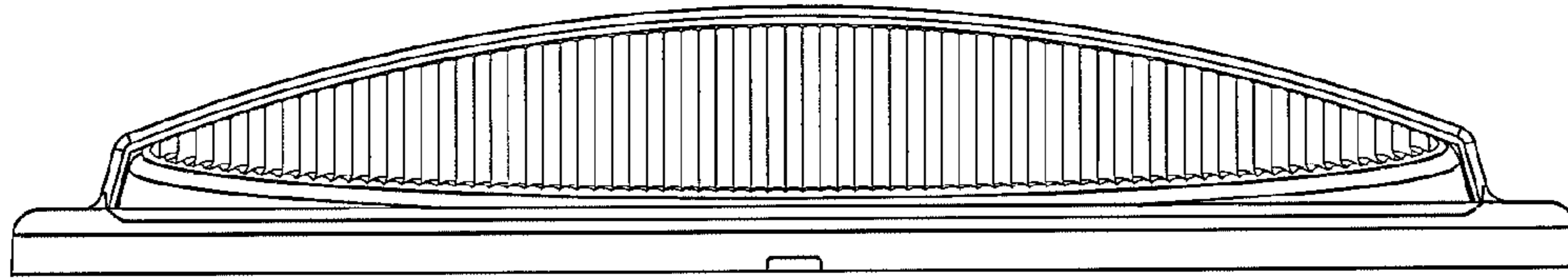

FIG. 3

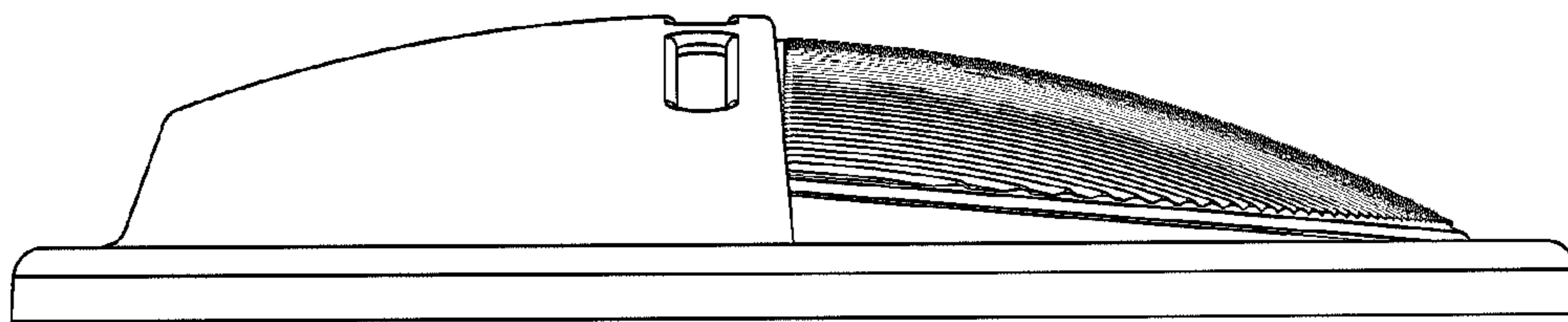

FIG. 4

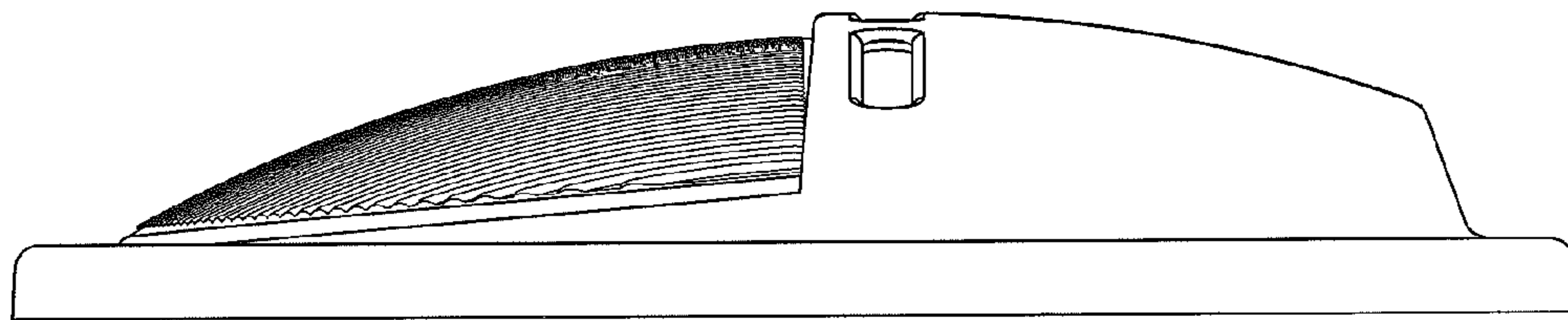

FIG. 5

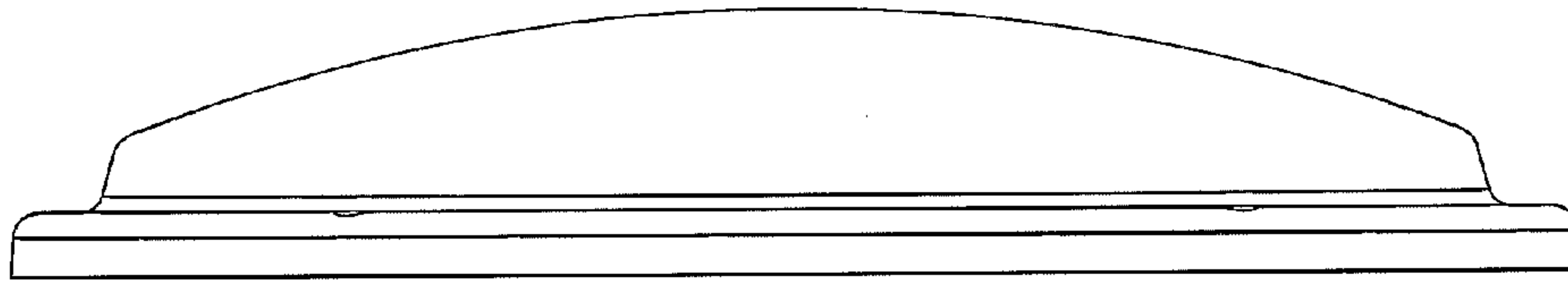

FIG. 6

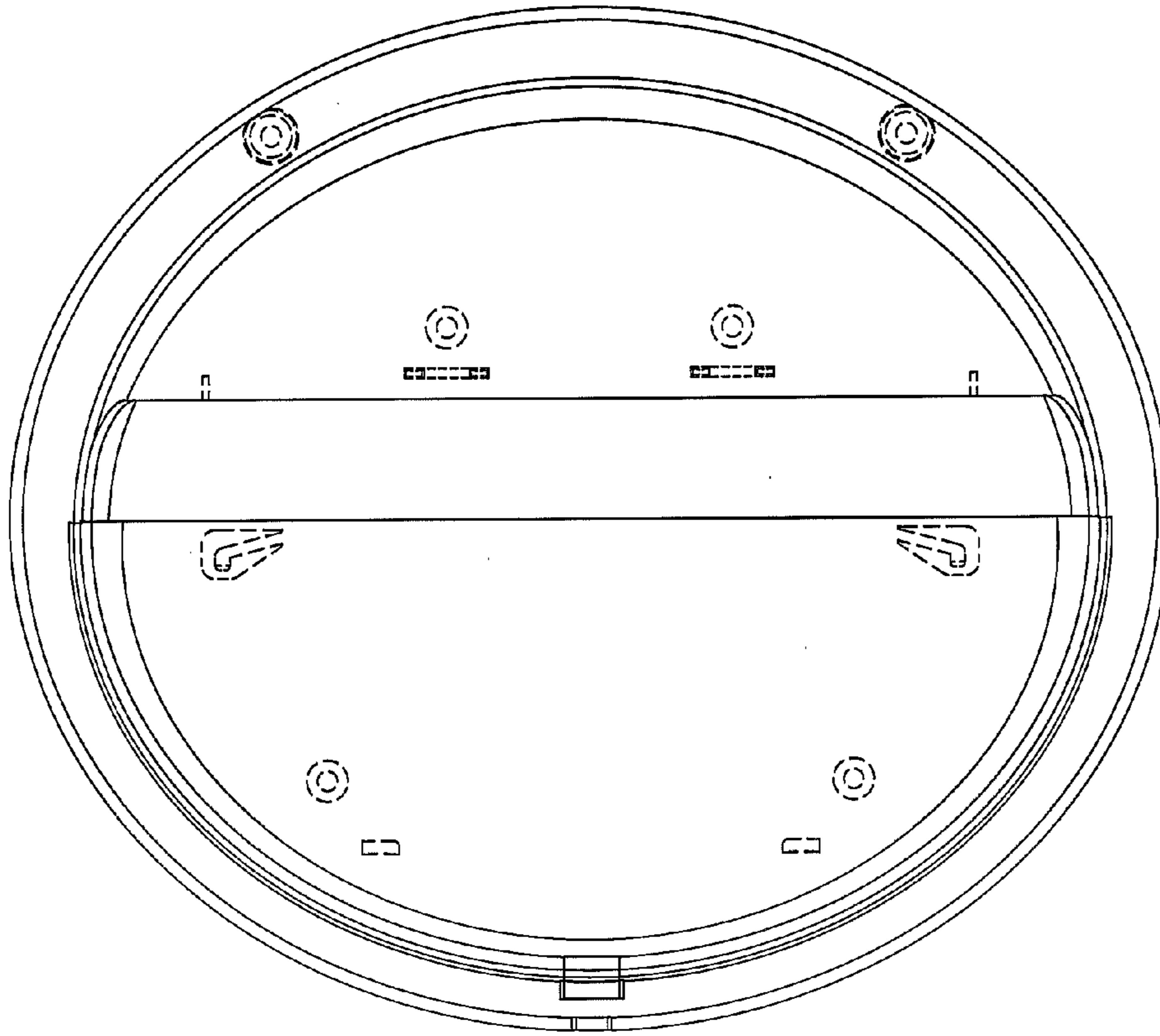
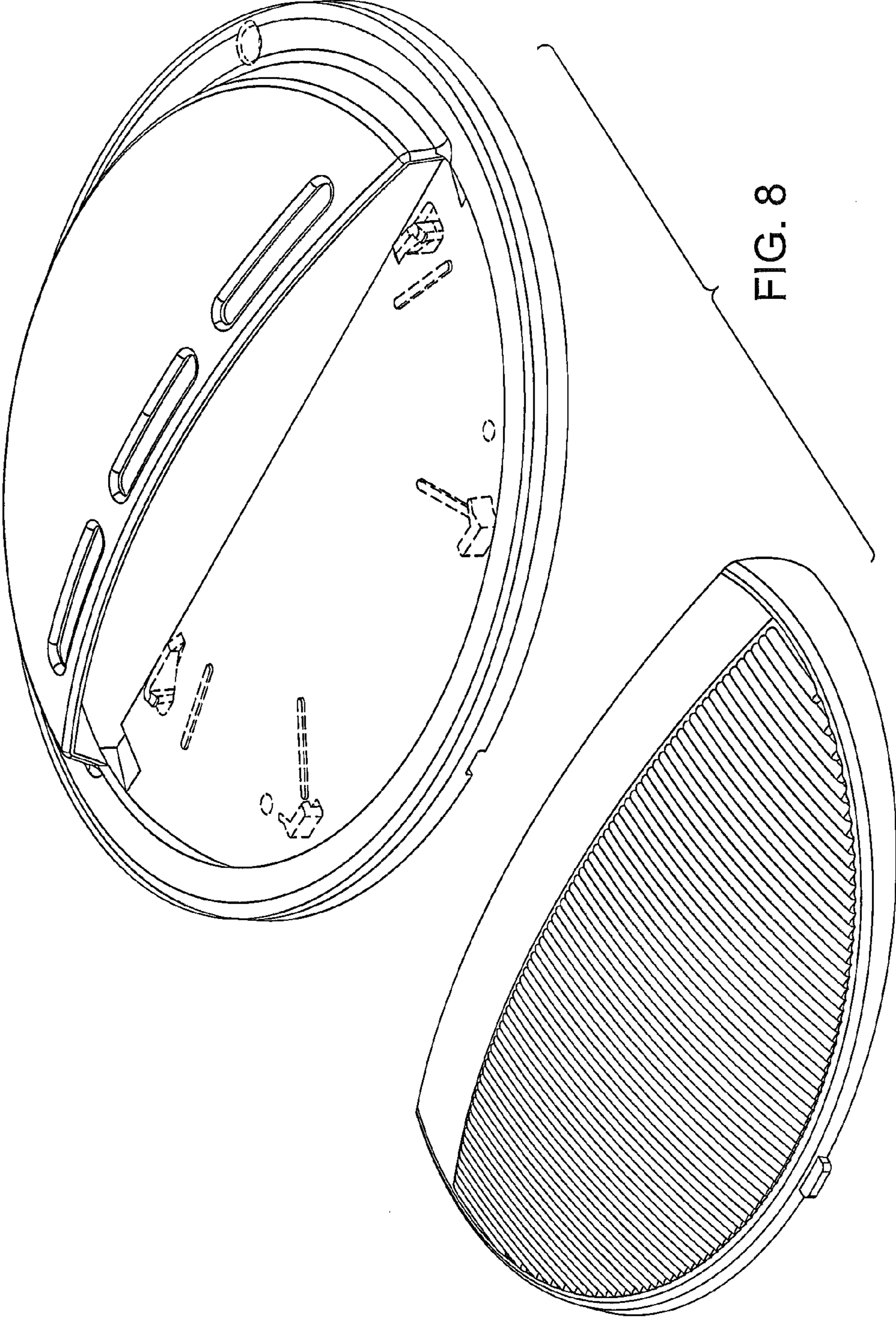

FIG. 7



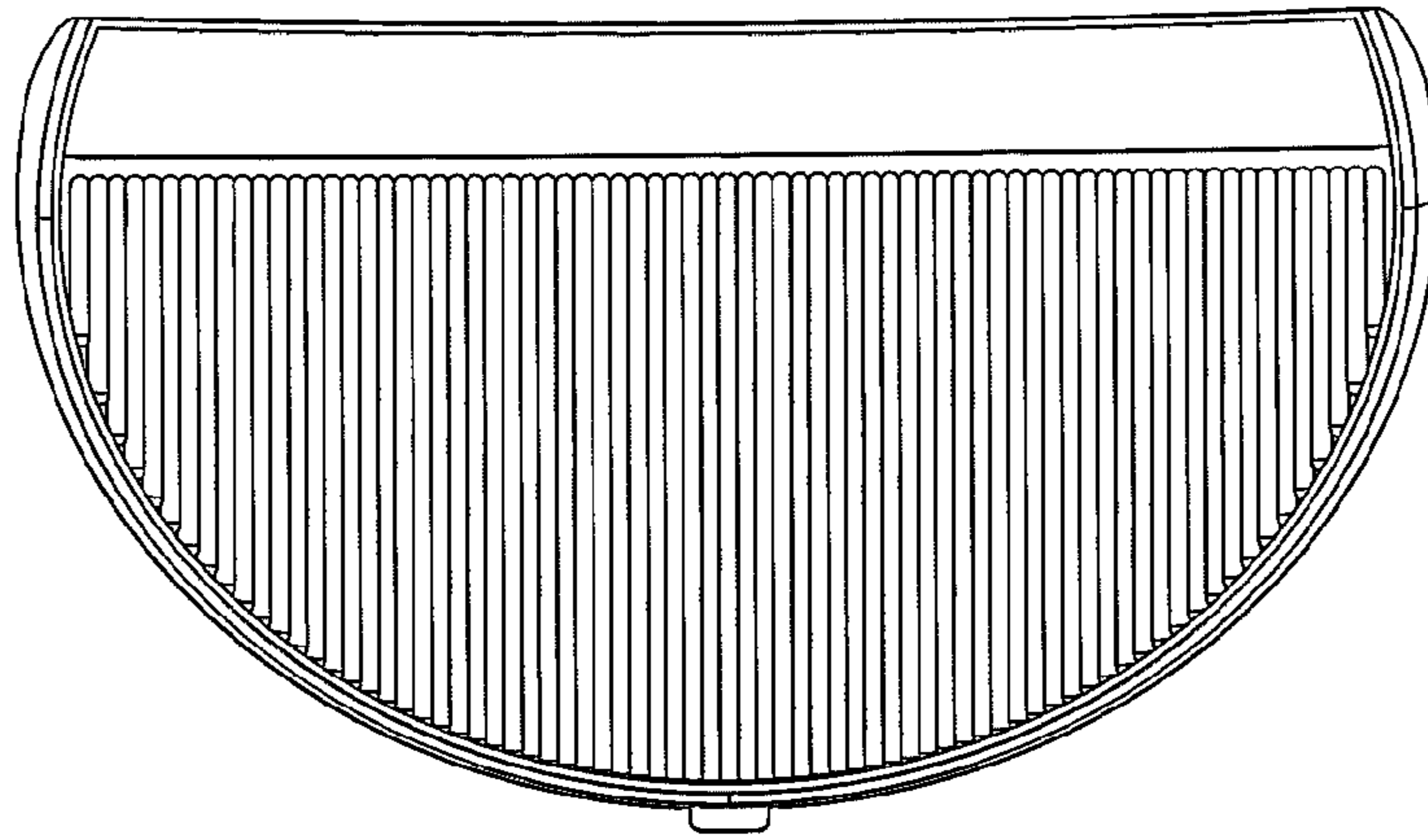

FIG. 9

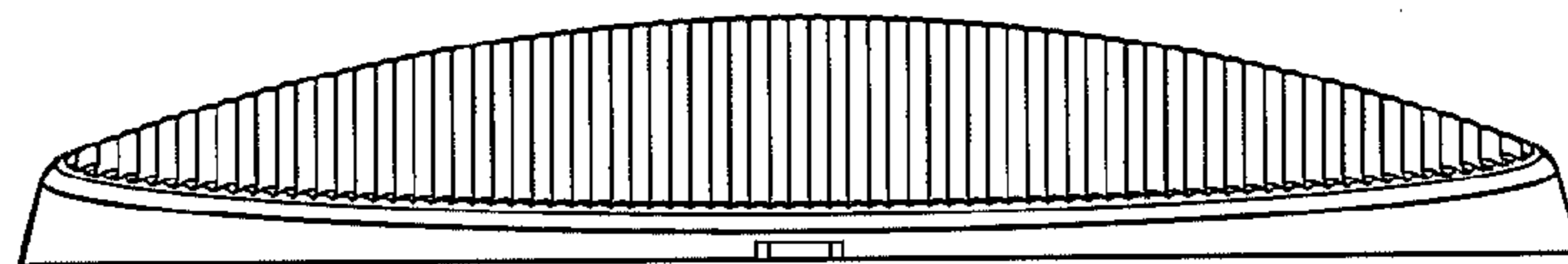

FIG. 10

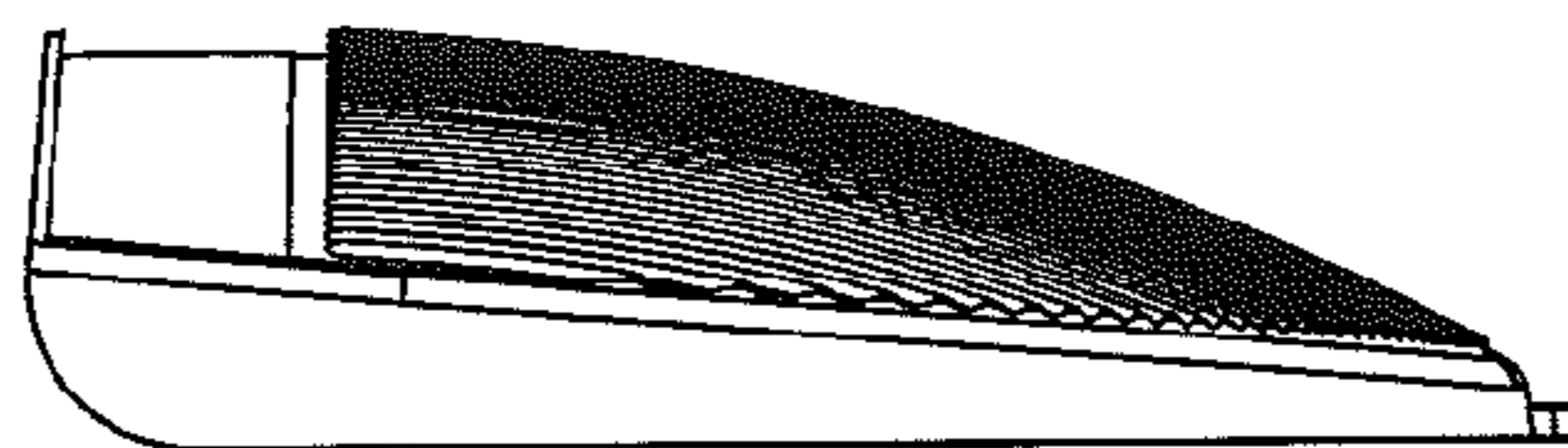

FIG. 11

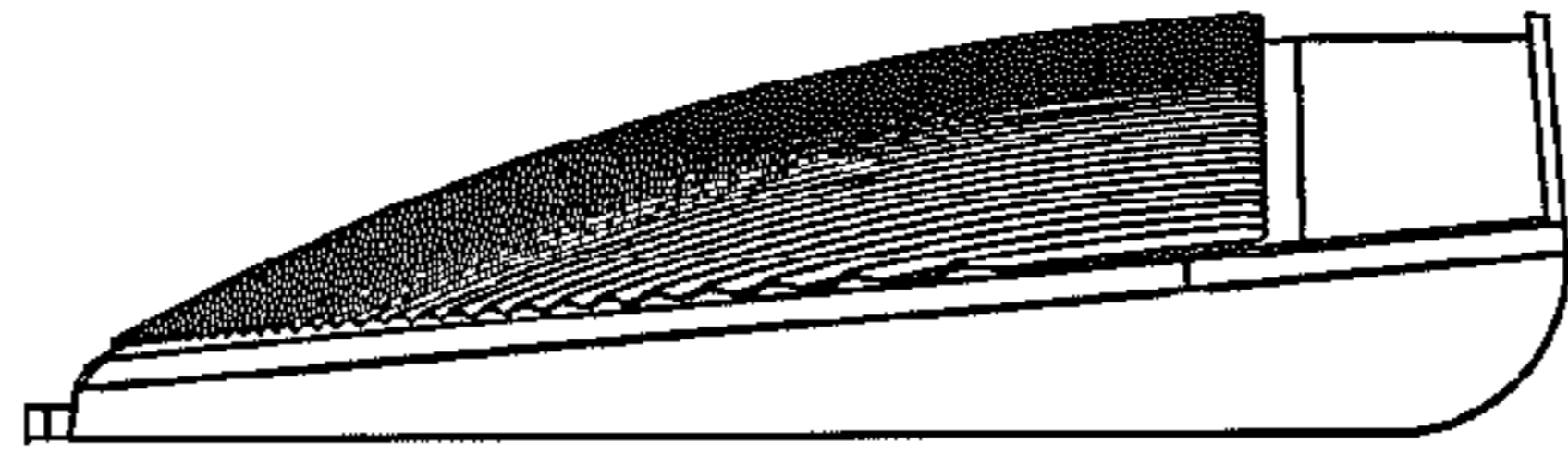

FIG. 12

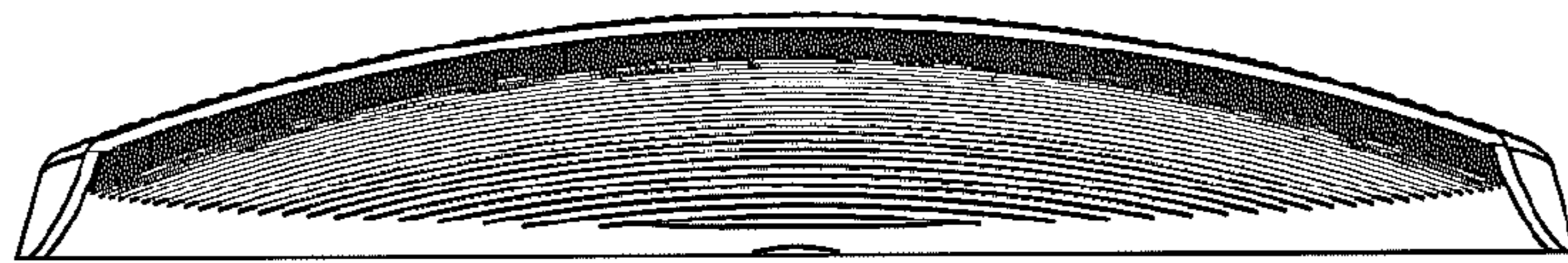

FIG. 13

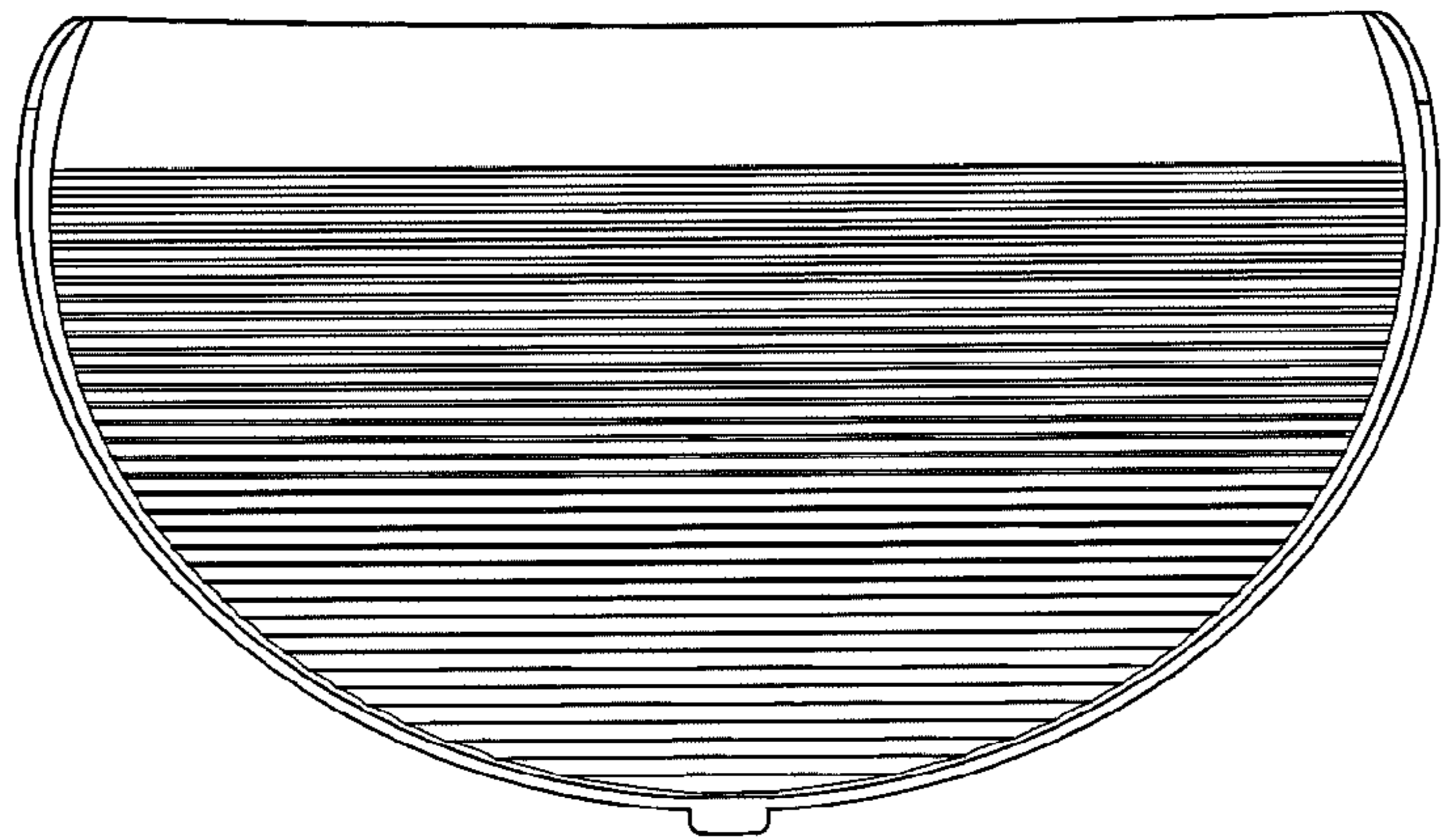

FIG. 14

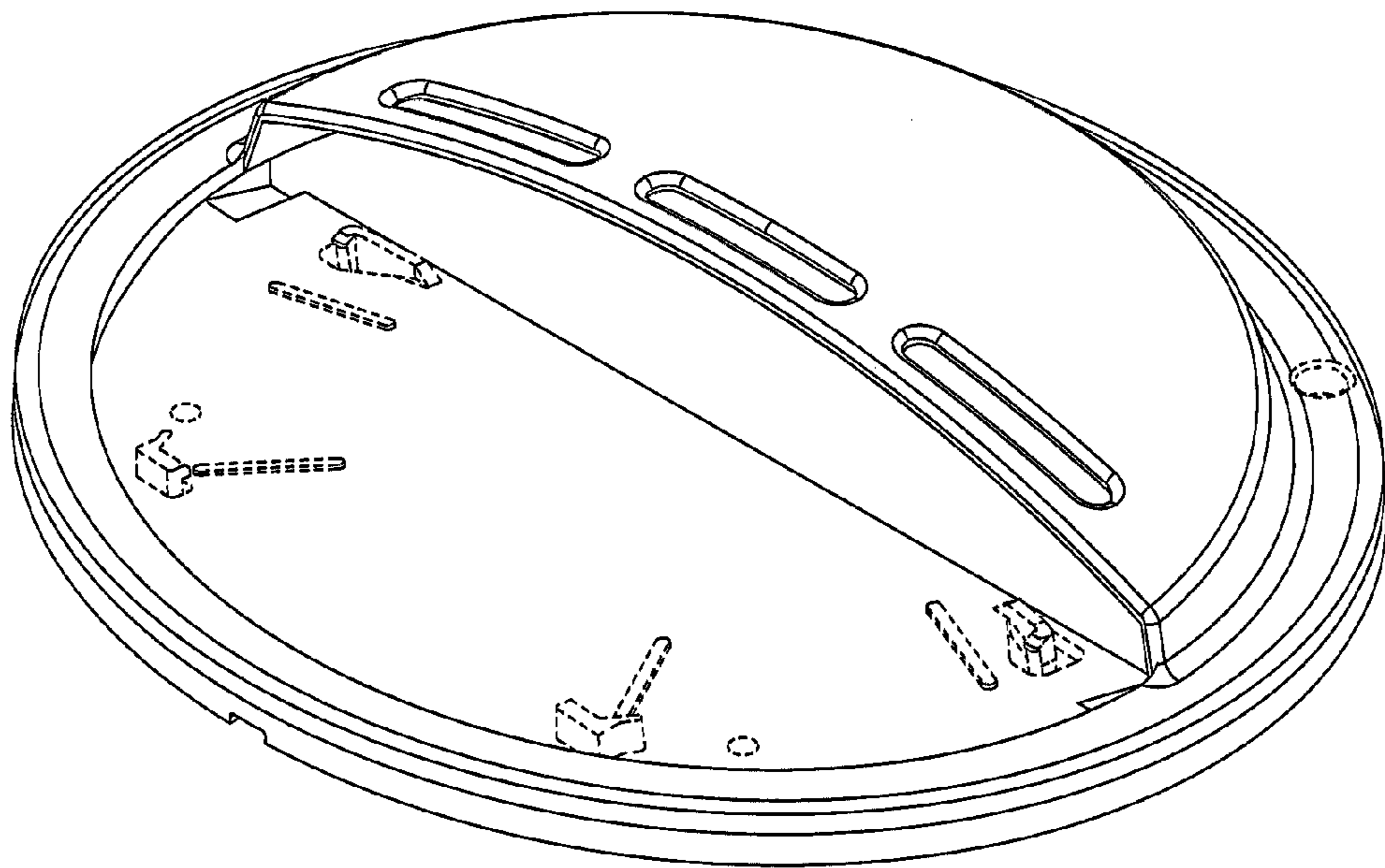

FIG. 15

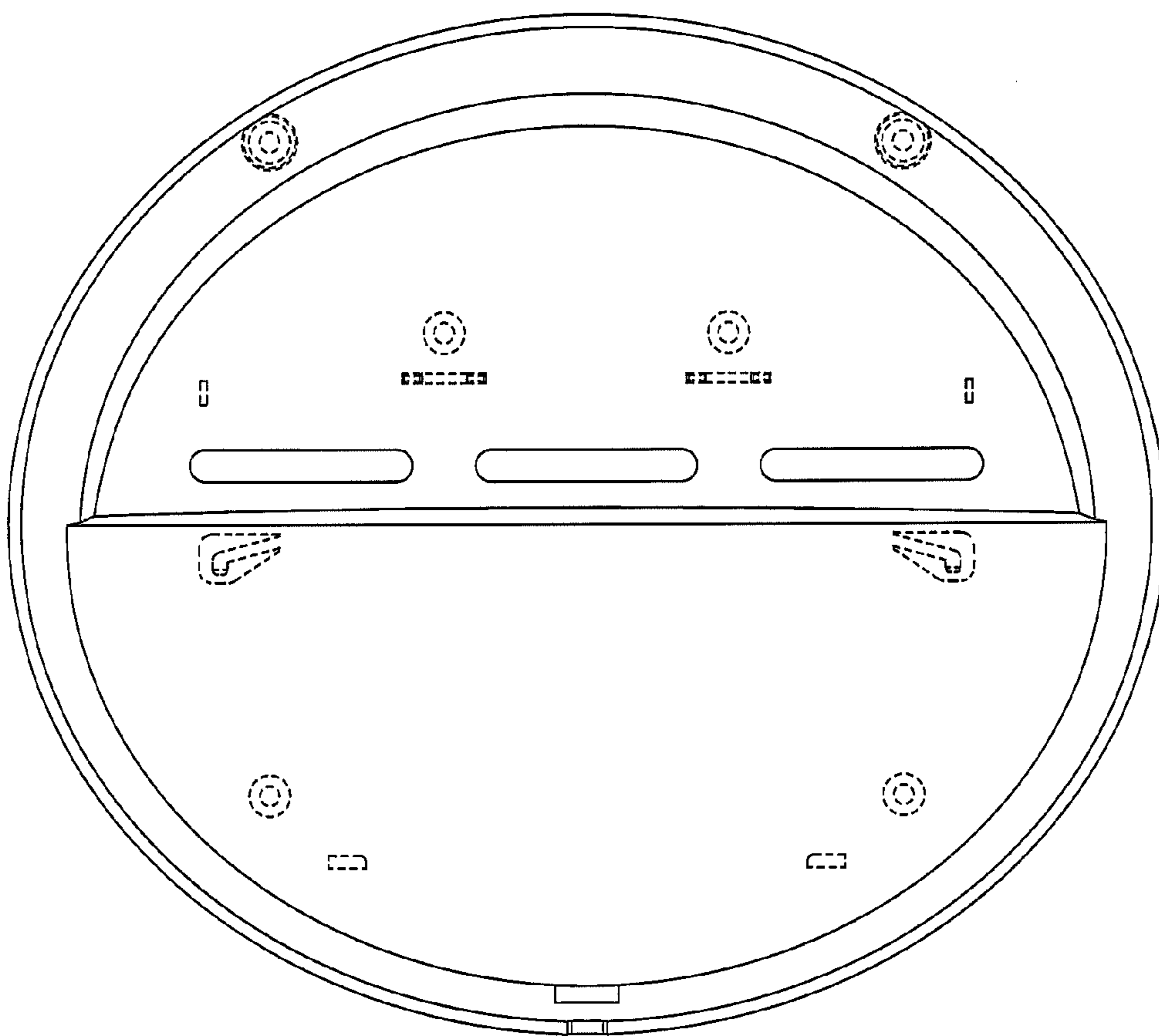

FIG. 16

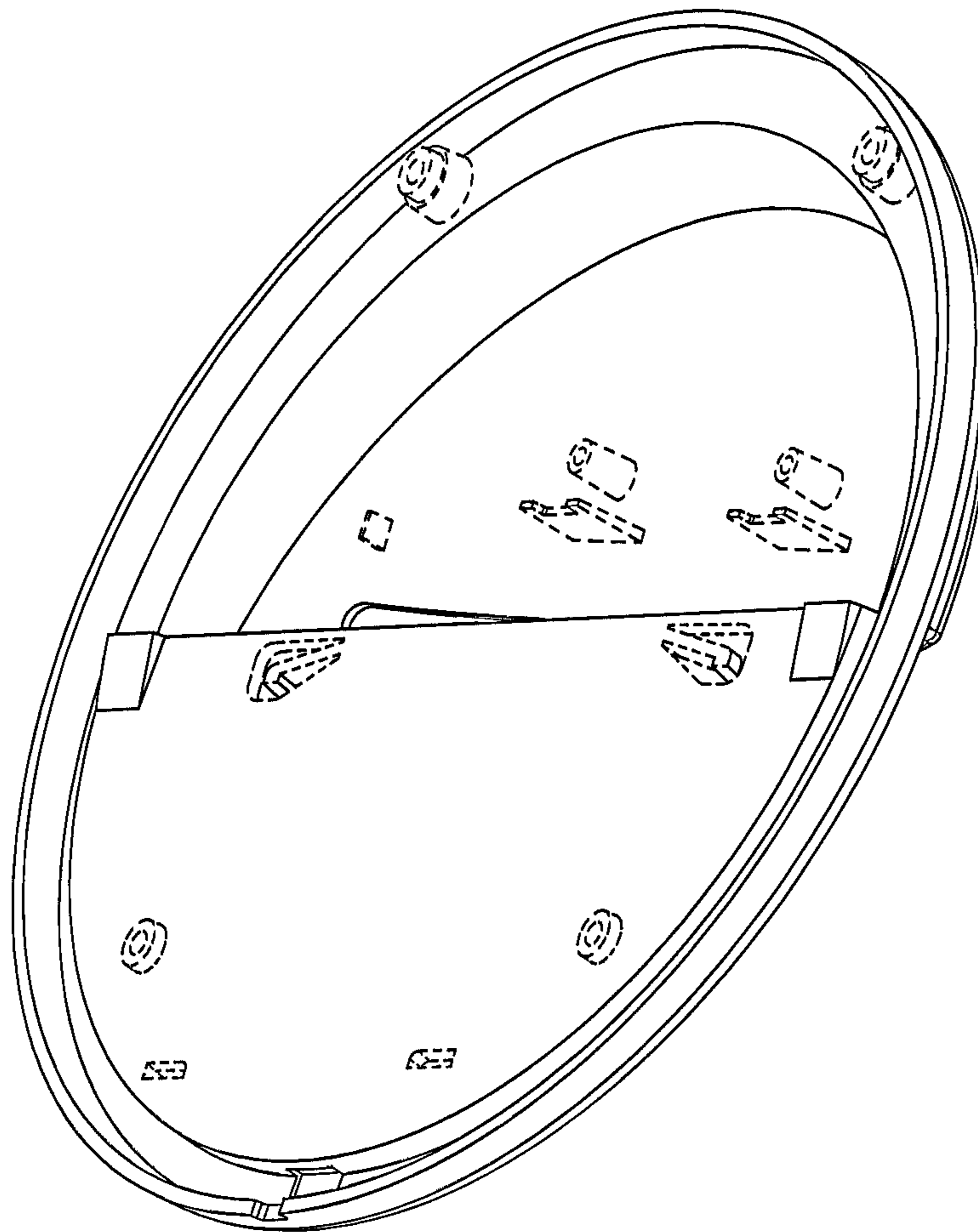

FIG. 17