



US00D723190S

(12) **United States Design Patent**  
**Kurihara et al.**

(10) **Patent No.:** **US D723,190 S**  
(45) **Date of Patent:** **\*\* Feb. 24, 2015**

(54) **SOUND CONTROL PANEL**

(75) Inventors: **Makoto Kurihara**, Hamamatsu (JP);  
**Yoshitaka Ide**, Hamamatsu (JP);  
**Yoshihiro Katsumata**, Hamamatsu (JP);  
**Eizo Amiya**, Hamamatsu (JP)

(73) Assignee: **Yamaha Corporation**, Shizuoka (JP)

(\*\*) Term: **14 Years**

(21) Appl. No.: **29/424,941**

(22) Filed: **Jun. 18, 2012**

(30) **Foreign Application Priority Data**

Jan. 17, 2012 (JP) ..... 2012-000729

(51) **LOC (10) Cl.** ..... **25-01**

(52) **U.S. Cl.**  
USPC ..... **D25/138**

(58) **Field of Classification Search**  
USPC ..... D25/138-140, 143, 144, 152, 156;  
181/184, 185, 196, 198, 284, 286, 292  
See application file for complete search history.

(56) **References Cited**

**U.S. PATENT DOCUMENTS**

1,924,240	A *	8/1933	Harwell	.....	144/347
D199,525	S *	11/1964	Keller	.....	D25/156
D302,019	S *	7/1989	Dehlen	.....	D15/147
D308,577	S *	6/1990	Hillman	.....	D25/138
D308,578	S *	6/1990	Hillman	.....	D25/138
D387,439	S *	12/1997	Ormiston	.....	D25/138
D397,454	S *	8/1998	Ormiston	.....	D25/138
D607,989	S *	1/2010	Llana Garcia	.....	D23/395
D710,037	S *	7/2014	Wakebe	.....	D25/143
2003/0192279	A1 *	10/2003	Hughart	.....	52/481.1

**FOREIGN PATENT DOCUMENTS**

JP	200930432	2/2009
JP	1363854 S	5/2009
JP	1387605 S	4/2010
JP	1387606 S	4/2010
KR	20020064738 A *	8/2002

**OTHER PUBLICATIONS**

Communication dated Jun. 3, 2013 from the Korean Intellectual Property Office in a counterpart application No. 30-2010-0028423.

\* cited by examiner

*Primary Examiner* — Rashida Johnson

(74) *Attorney, Agent, or Firm* — Sughrue Mion, PLLC

(57) **CLAIM**

The ornamental design for a sound control panel, as shown and described.

**DESCRIPTION**

FIG. 1 is a perspective view of the front, top and right side of a sound control panel showing our new design;  
FIG. 2 is a front view thereof;  
FIG. 3 is a rear view thereof;  
FIG. 4 is a right side view thereof, the left side being a mirror image;  
FIG. 5 is a top plan view thereof, the bottom being a mirror image;  
FIG. 6 is an enlarged cross sectional view at 6-6 shown in FIG. 2;  
FIG. 7 is an enlarged view at 7-7 shown in FIG. 2;  
FIG. 8 is an enlarged view at 8-8 shown in FIG. 6; and,  
FIG. 9 is a perspective reference view of the sound control panel to which the legs are attached.  
The broken lines in FIG. 9 represent the portions of the sound control panel, which form no part of the claimed design.

**1 Claim, 6 Drawing Sheets**

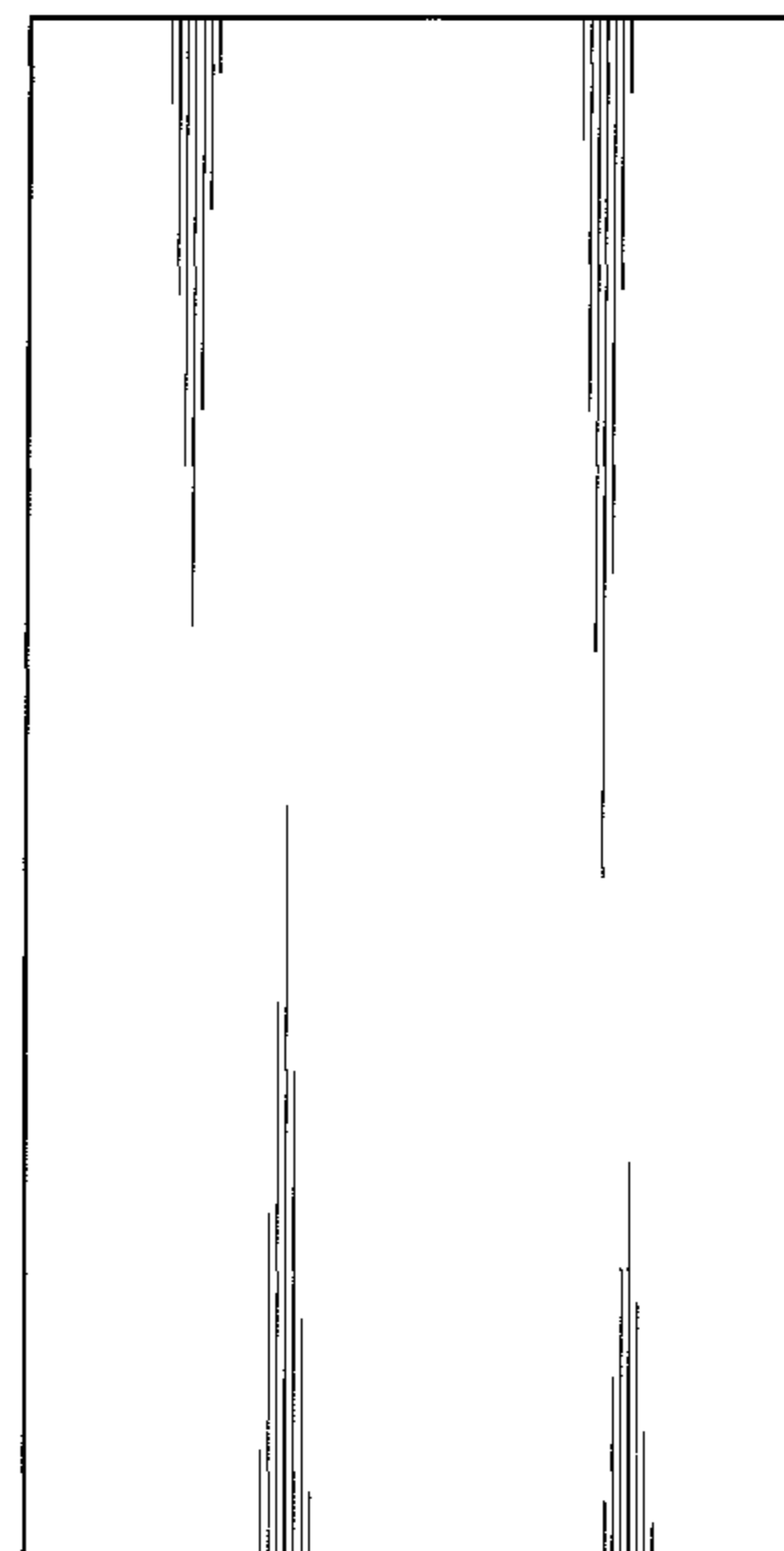
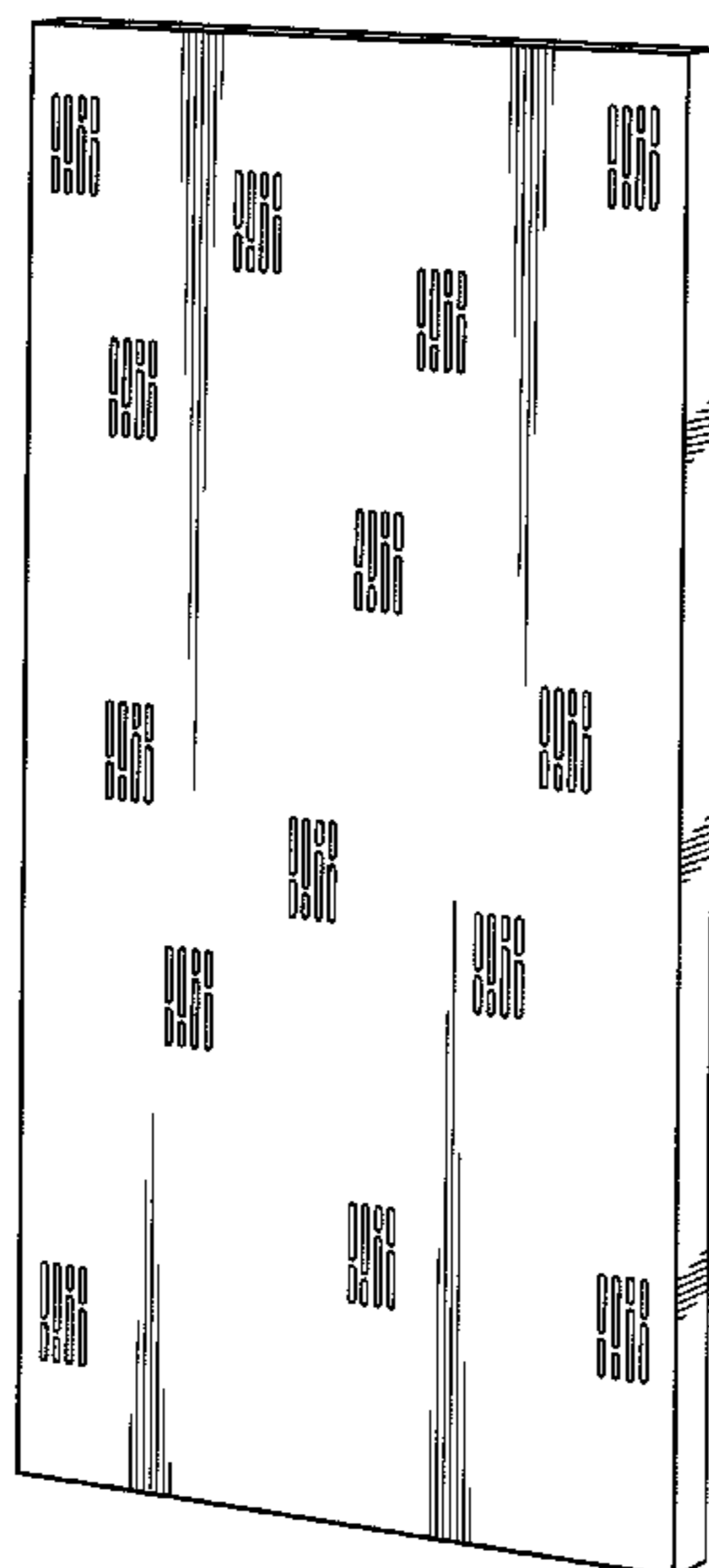

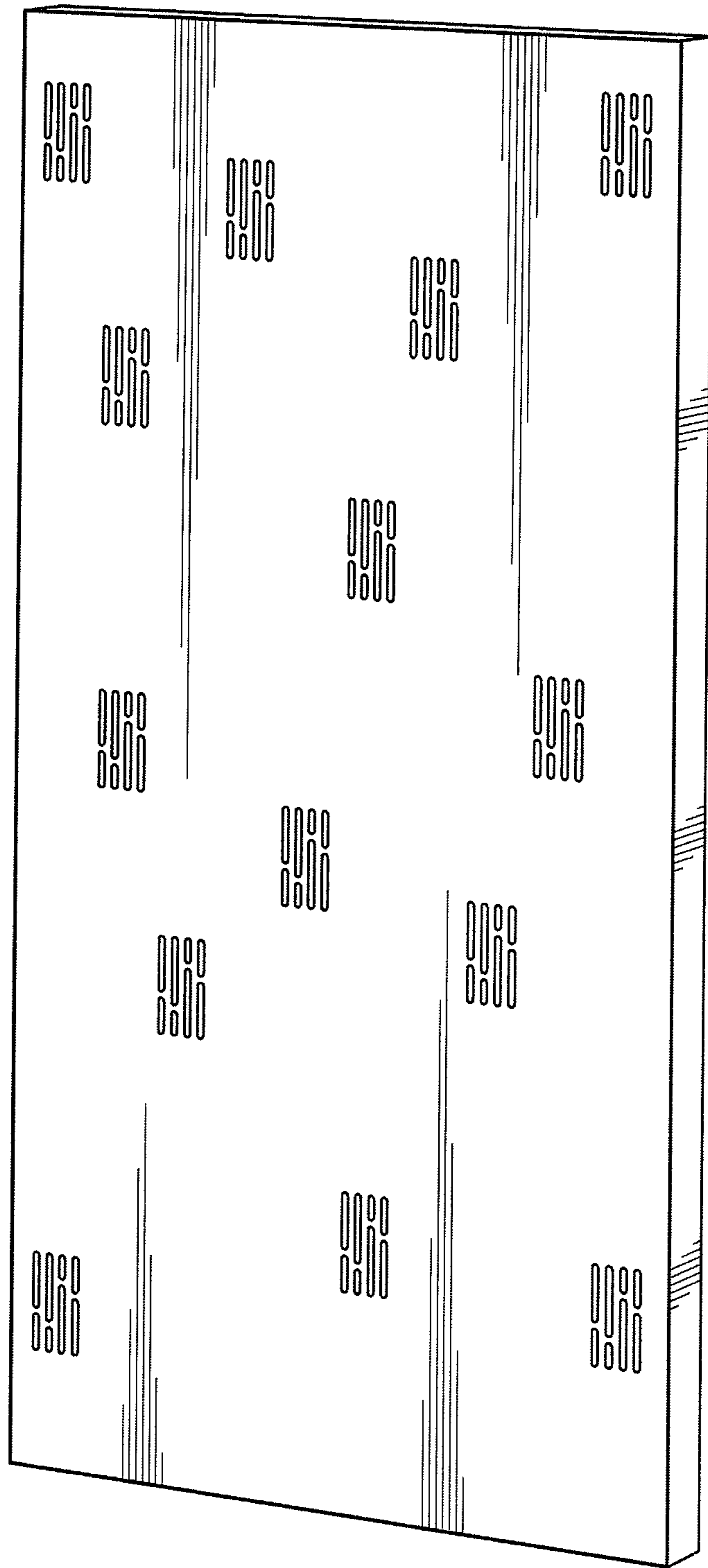

FIG. 1

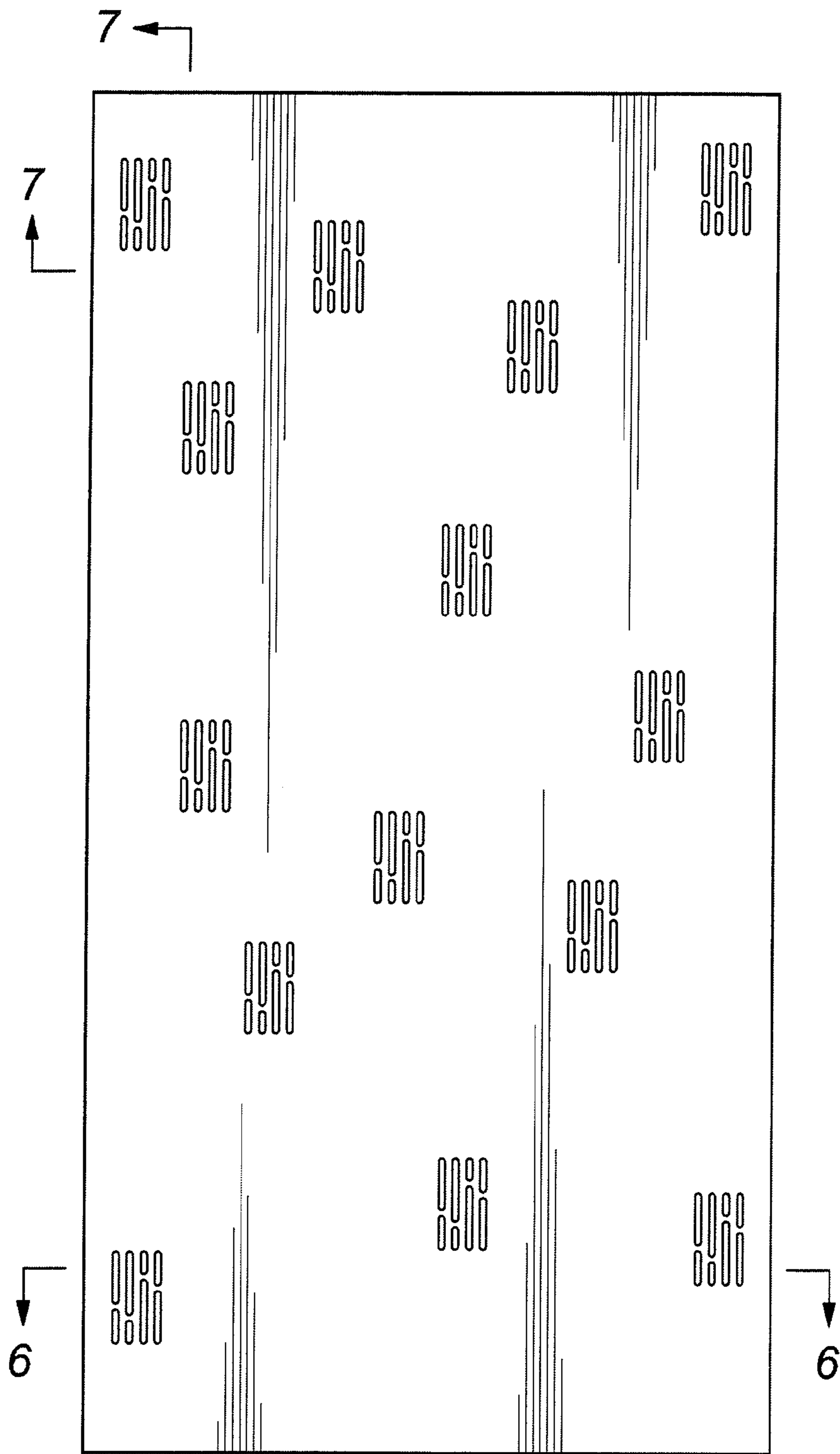

FIG. 2

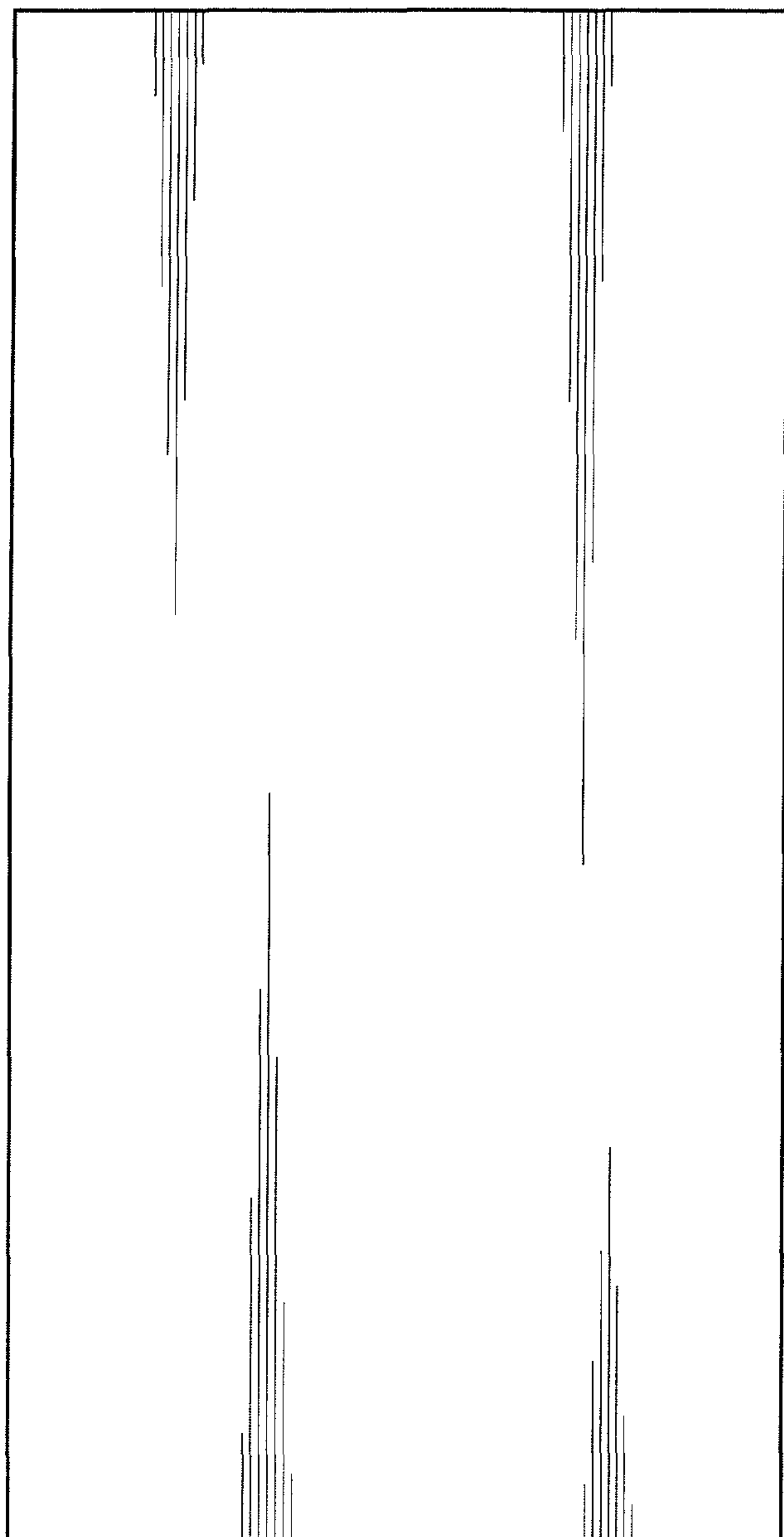

FIG. 3



FIG. 4



FIG. 5

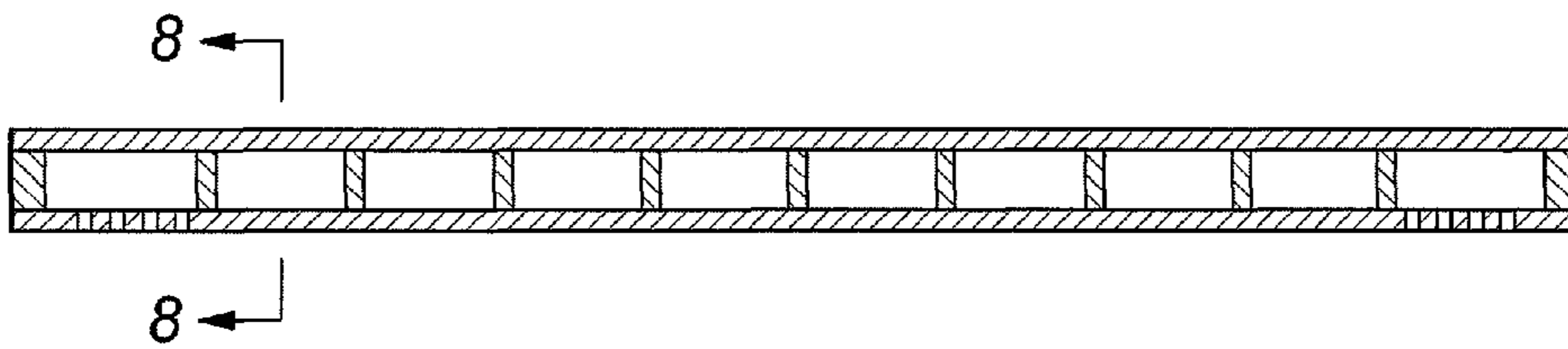
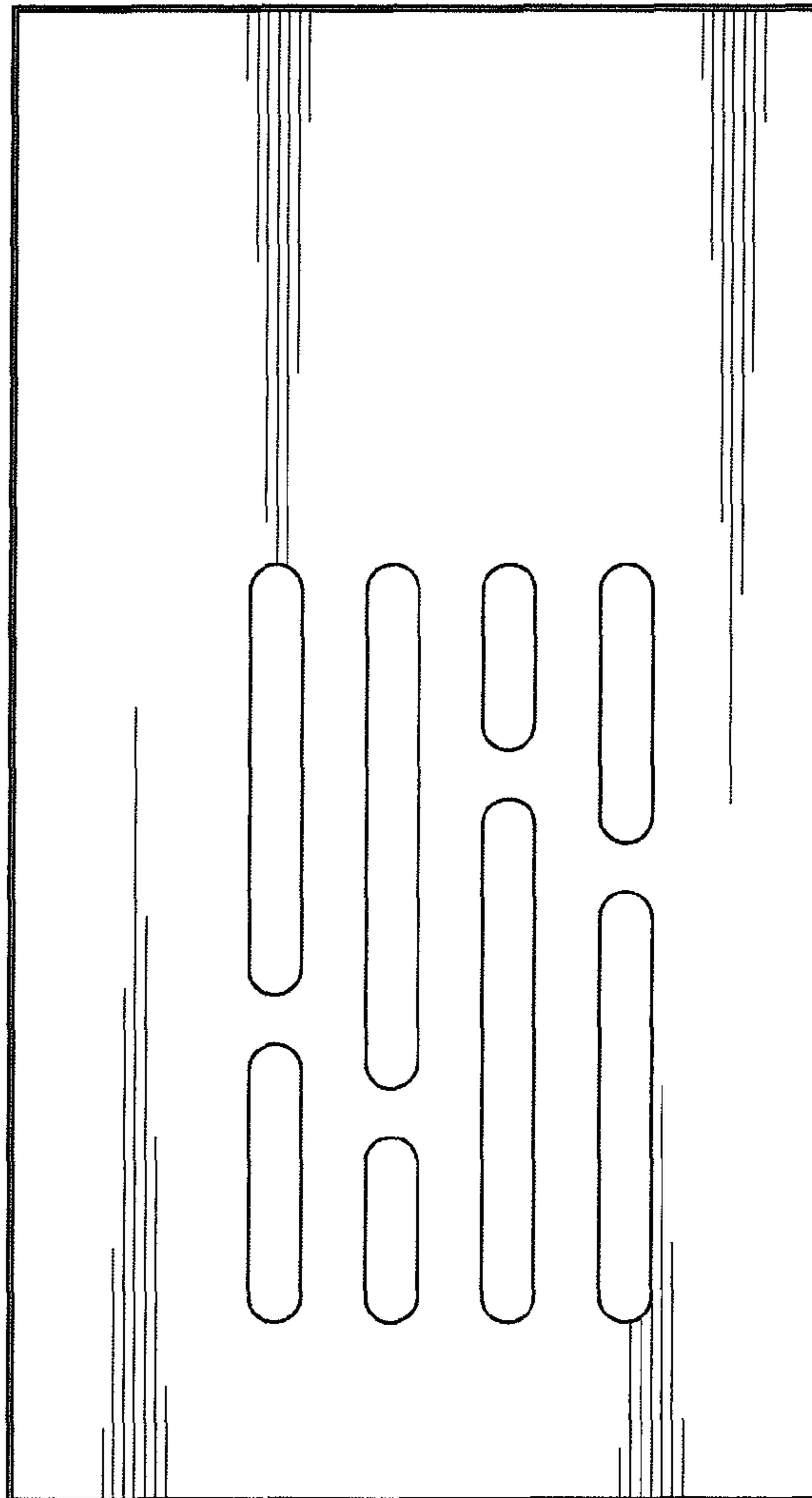
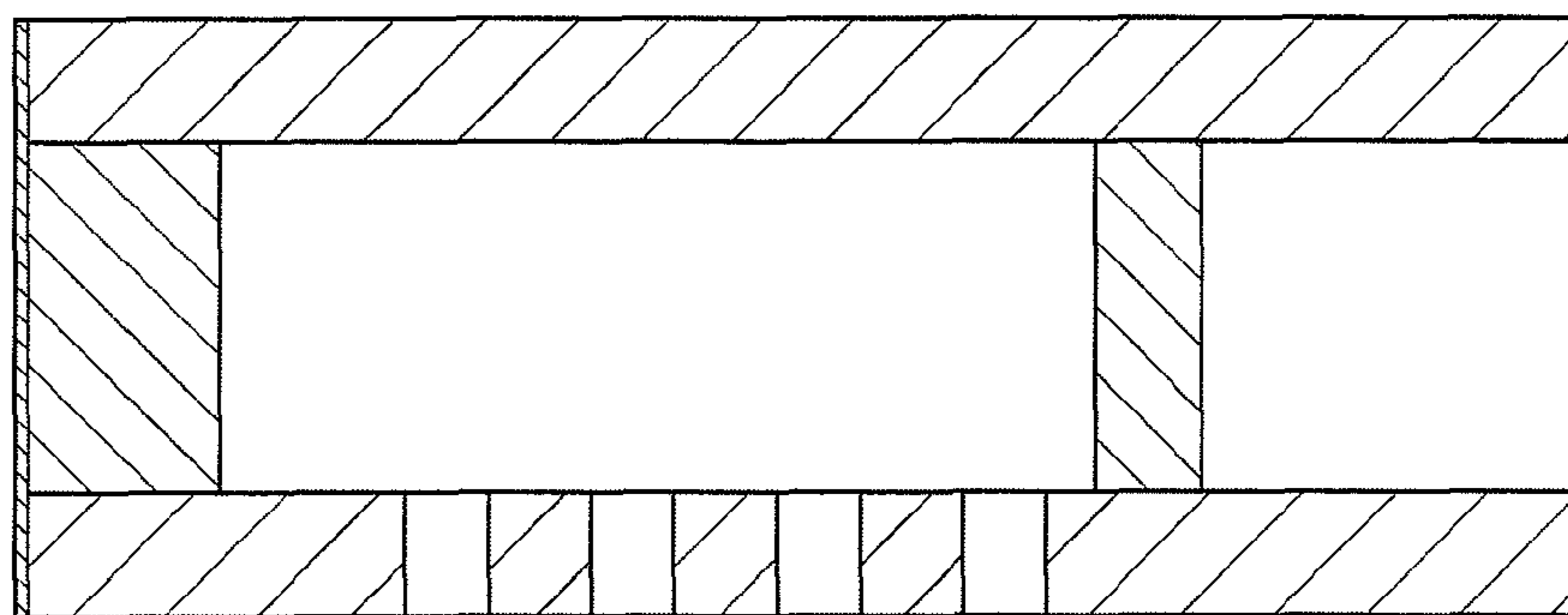

FIG. 6



*FIG. 7*



*FIG. 8*

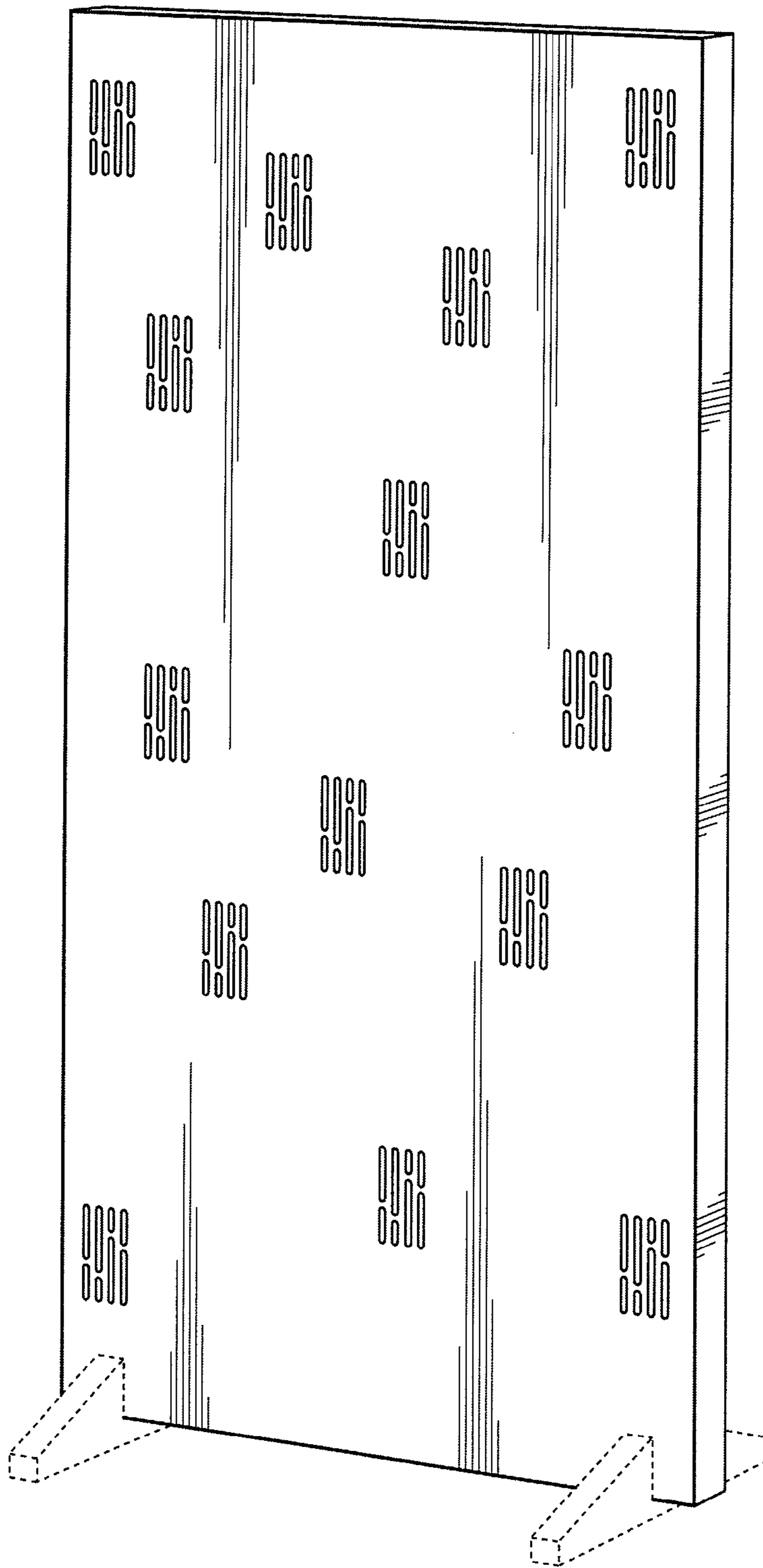

FIG. 9