

US00D723015S

(12) **United States Design Patent**  
**Koh**

(10) **Patent No.:** **US D723,015 S**  
(45) **Date of Patent:** **\*\* Feb. 24, 2015**

(54) **MOBILE PHONE**

(71) Applicant: **Samsung Electronics Co., Ltd.**,  
Suwon-si (KR)

(72) Inventor: **Min-Ah Koh**, Seoul (KR)

(73) Assignee: **Samsung Electronics Co., Ltd.**,  
Suwon-si (KR)

(\*\*) Term: **14 Years**

(21) Appl. No.: **29/464,675**

(22) Filed: **Aug. 20, 2013**

(30) **Foreign Application Priority Data**

Feb. 20, 2013 (KR) ..... 30-2013-0008639

(51) **LOC (10) Cl.** ..... **14-03**

(52) **U.S. Cl.**  
USPC ..... **D14/248**

(58) **Field of Classification Search**

CPC ..... H04M 1/02; H04M 1/0202-1/035;  
G06F 1/1626

USPC ..... D14/138 G, 138 AD, 138 AA, 341, 346,  
D14/138 R, 496, 203.1-203.7, 248, 218,  
D14/439, 217, 191; 455/575.1, 556.2,  
455/575.3, 575.4; D21/517, 329, 331, 333;  
D10/65, 78; 379/433.01, 433.04;  
361/679.3, 679.56

See application file for complete search history.

(56) **References Cited**

U.S. PATENT DOCUMENTS

D464,961 S \* 10/2002 Sogabe ..... D14/346  
D527,000 S \* 8/2006 Hong et al. .... D14/346  
7,200,224 B2 \* 4/2007 Park et al. .... 379/433.13  
D580,391 S \* 11/2008 Kim et al. .... D14/138 AD  
7,594,638 B2 \* 9/2009 Chan et al. .... 248/677  
D601,994 S \* 10/2009 Kim et al. .... D14/138 G

D626,110 S \* 10/2010 Kim ..... D14/203.7  
D631,456 S \* 1/2011 Chung et al. .... D14/138 G  
D635,115 S \* 3/2011 Li ..... D14/138 G

(Continued)

OTHER PUBLICATIONS

Samsung Galaxy W I8150 telephone, announced Aug. 2011,  
[online], [site visited Sep. 4, 2014]. Available from Internet, <URL:  
[http://www.gsmarena.com/samsung\\_galaxy\\_w\\_i8150-4114.php](http://www.gsmarena.com/samsung_galaxy_w_i8150-4114.php)>.\*

(Continued)

Primary Examiner — Jeffrey D Asch

(74) Attorney, Agent, or Firm — NSIP Law

(57) **CLAIM**

The ornamental design for a mobile phone, as shown and described.

**DESCRIPTION**

FIG. 1 is a front perspective view of a mobile phone showing my new design;

FIG. 2 is a front view thereof;

FIG. 3 is a rear view thereof;

FIG. 4 is a left-side view thereof;

FIG. 5 is a right-side view thereof;

FIG. 6 is a top view thereof;

FIG. 7 is a bottom view thereof;

FIG. 8 is an enlarged view of the encircled portion shown in FIG. 2; and,

FIG. 9 is an enlarged view of the encircled portion shown in FIG. 3.

The circular feature shown in broken lines within the claimed surface represents a boundary of the claim. All other broken lines show portions of the mobile phone that form no part of the claimed design. The broken lines form no part of the claimed design.

The dot-dash broken lines encircling portions of the claimed design that are illustrated in enlargements form no part of the claimed design.

The shade lines in the figures show contour and not surface ornamentation.

**1 Claim, 5 Drawing Sheets**

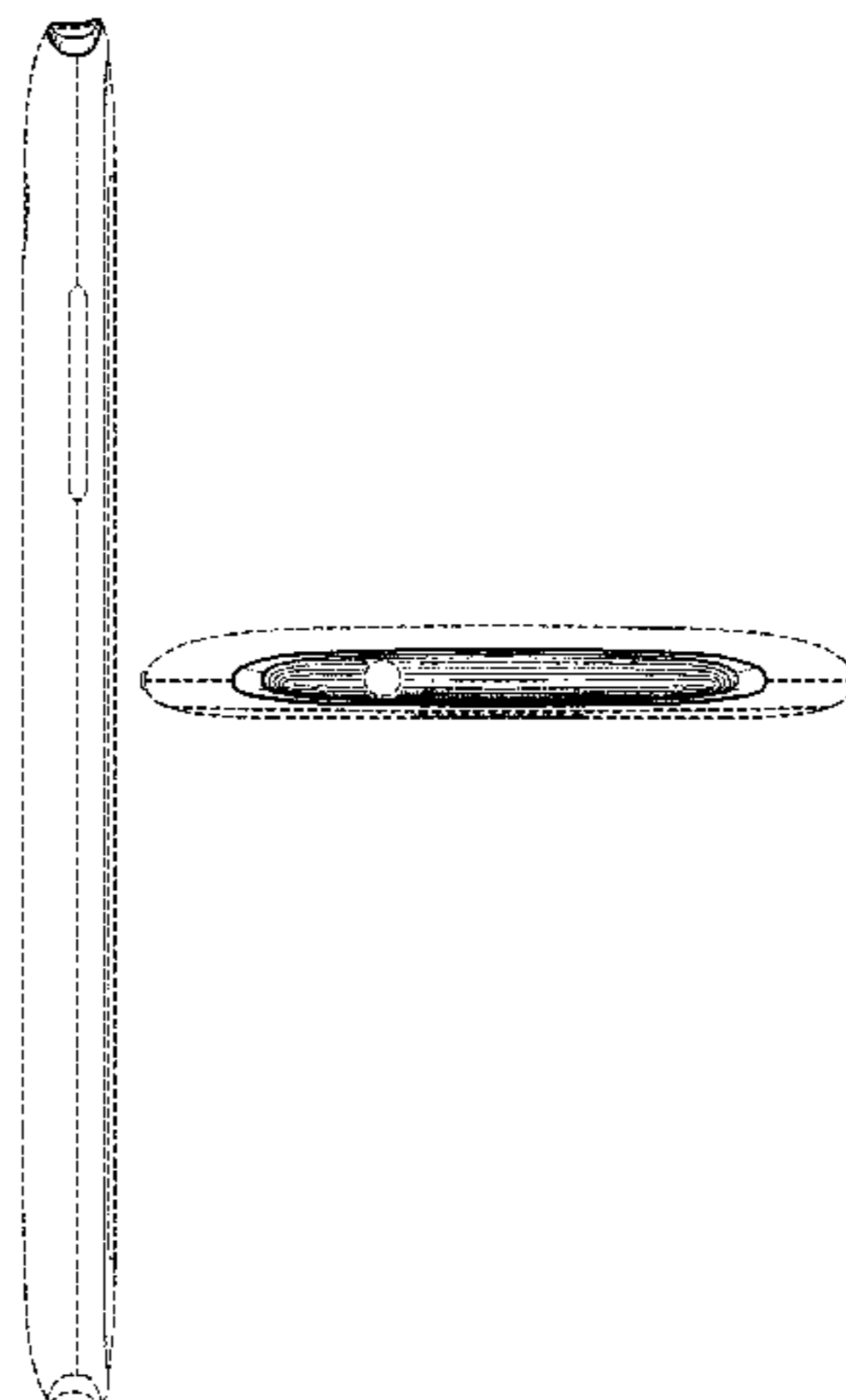

(56)

**References Cited**

U.S. PATENT DOCUMENTS

D645,439 S \* 9/2011 Lee et al. .... D14/138 AD  
 D653,639 S \* 2/2012 Kim et al. .... D14/138 G  
 D662,486 S \* 6/2012 Faoro ..... D14/138 G  
 D663,279 S \* 7/2012 Kim et al. .... D14/138 G  
 D664,515 S \* 7/2012 Fagnot et al. .... D14/138 G  
 D665,766 S \* 8/2012 Eguchi ..... D14/138 G  
 D669,050 S \* 10/2012 Lyles et al. .... D14/138 G  
 D670,288 S \* 11/2012 Chen ..... D14/341  
 D676,011 S \* 2/2013 Park et al. .... D14/138 G  
 D677,232 S \* 3/2013 Park ..... D14/138 G  
 D681,590 S \* 5/2013 Han ..... D14/138 G  
 D687,402 S \* 8/2013 Park ..... D14/138 G  
 D689,049 S \* 9/2013 Chang et al. .... D14/341  
 8,523,124 B2 \* 9/2013 Yuan et al. .... 248/188.8  
 D696,654 S \* 12/2013 Lee ..... D14/248  
 D697,891 S \* 1/2014 Yoo ..... D14/138 G  
 D703,178 S \* 4/2014 Park et al. .... D14/138 G  
 8,723,737 B2 \* 5/2014 Hsiung ..... 343/702  
 D706,739 S \* 6/2014 Zhang et al. .... D14/138 G

D709,473 S \* 7/2014 Kim et al. .... D14/138 G  
 D710,816 S \* 8/2014 Koh ..... D14/138 G  
 D711,339 S \* 8/2014 Yang ..... D14/138 G

OTHER PUBLICATIONS

Nokia 801T telephone, announced Nov. 2013, [online], [site visited Sep. 4, 2014]. Available from Internet, <URL: [http://www.gsmarena.com/nokia\\_801t-4391.php](http://www.gsmarena.com/nokia_801t-4391.php)>.\*  
 Samsung Omnia W I8350 telephone, announced Sep. 2011, [online], [site visited Sep. 4, 2014]. Available from Internet, <URL: [http://www.gsmarena.com/samsung\\_omnia\\_w\\_i8350-4200.php](http://www.gsmarena.com/samsung_omnia_w_i8350-4200.php)>.\*  
 Samsung Exhibit 4G telephone, announced Jun. 2011, [online], [site visited Sep. 4, 2014]. Available from Internet, <URL: [http://www.gsmarena.com/samsung\\_exhibit\\_4g-3968.php](http://www.gsmarena.com/samsung_exhibit_4g-3968.php)>.\*  
 Samsung I8700 Omnia 7 telephone, announced Oct. 2010, [online], [site visited Sep. 4, 2014]. Available from Internet, <URL: [http://www.gsmarena.com/samsung\\_i8700\\_omnia\\_7-pictures-3537.php](http://www.gsmarena.com/samsung_i8700_omnia_7-pictures-3537.php)>.\*  
 Plum Buzz telephone, announced Feb. 2012, [online], [site visited Sep. 4, 2014]. Available from Internet, <URL: [http://www.gsmarena.com/plum\\_buzz-4937.php](http://www.gsmarena.com/plum_buzz-4937.php)>.\*

\* cited by examiner

FIG. 1

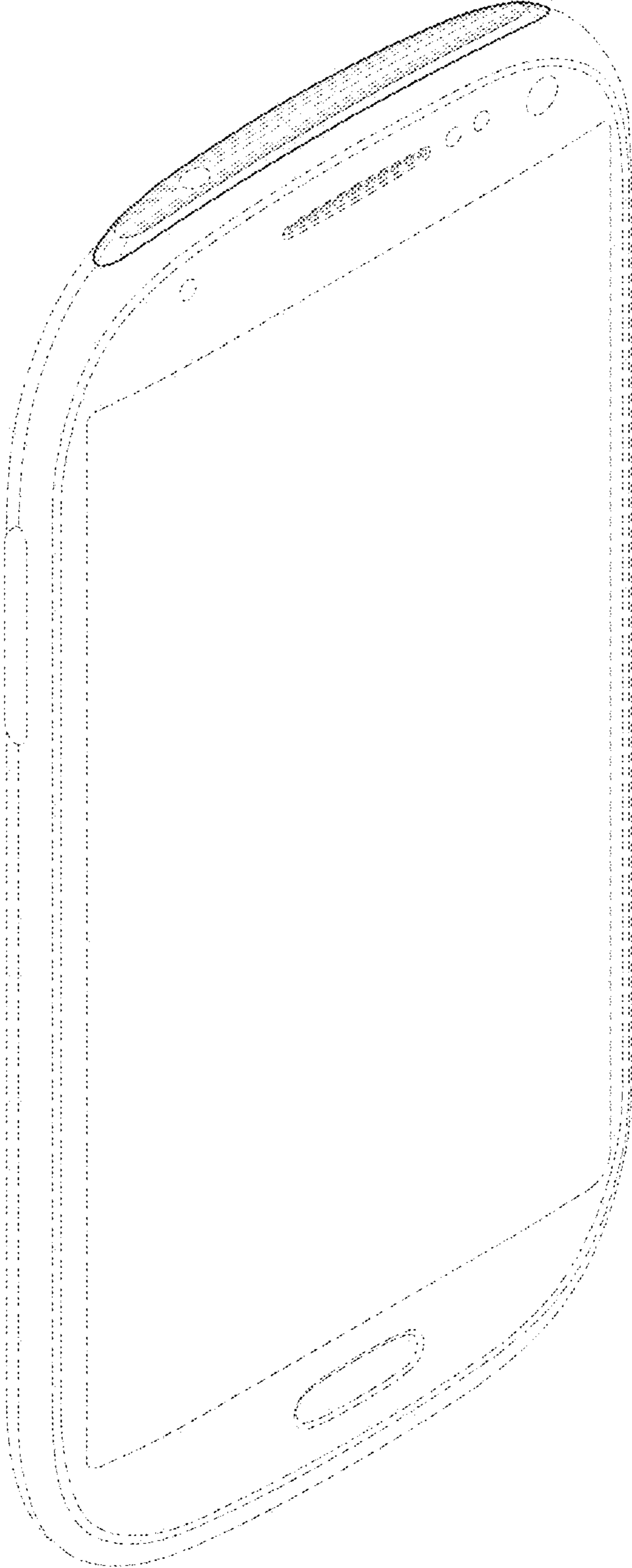

FIG.2

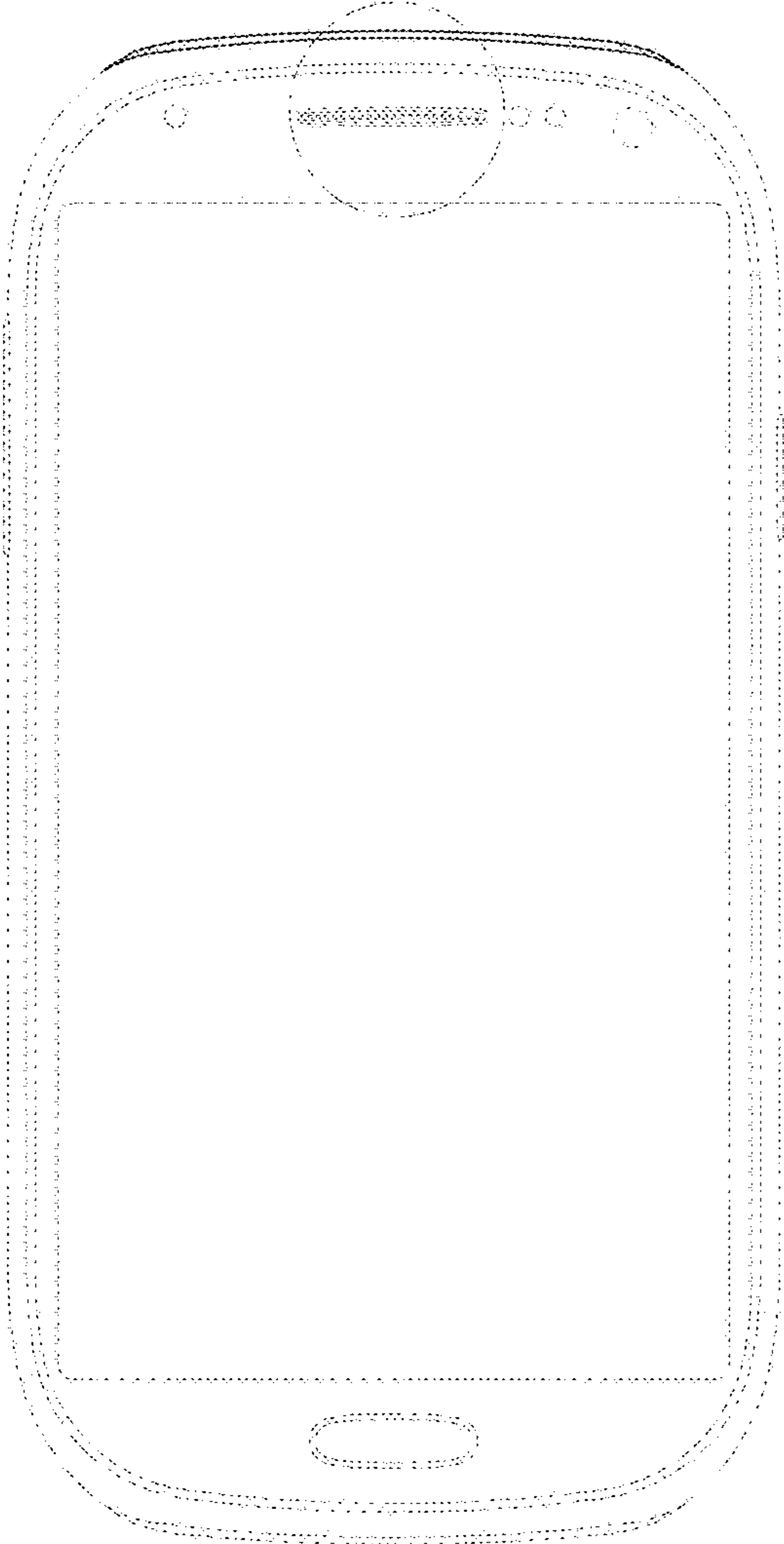

FIG.3

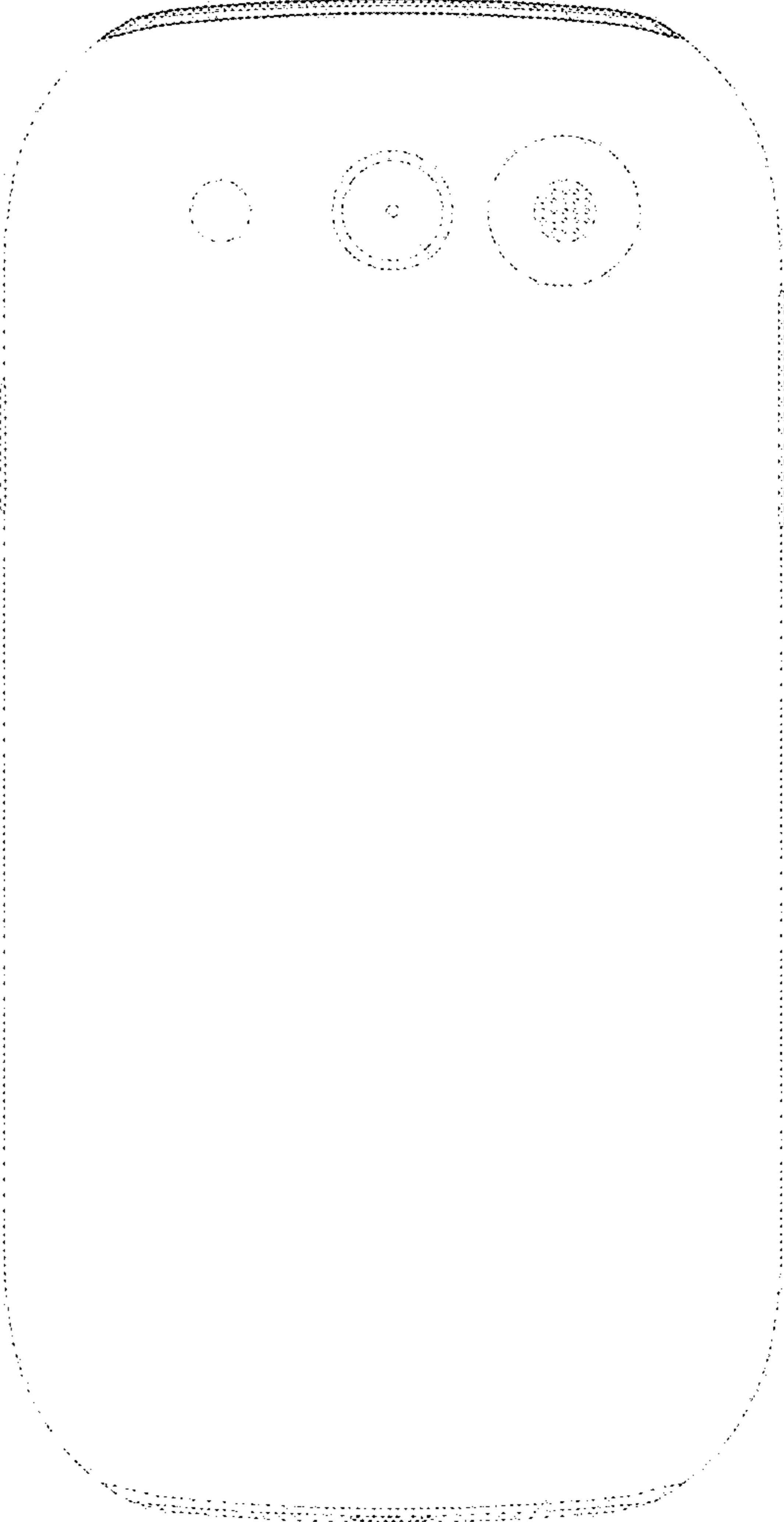

FIG. 4

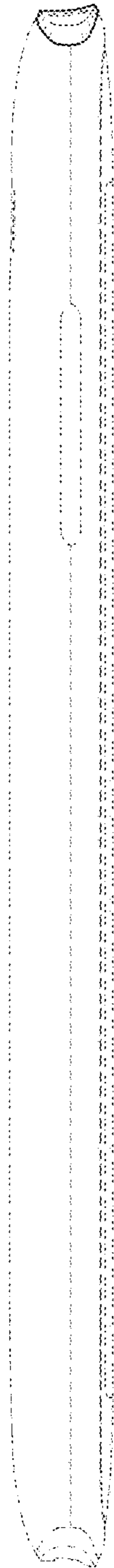

FIG. 5

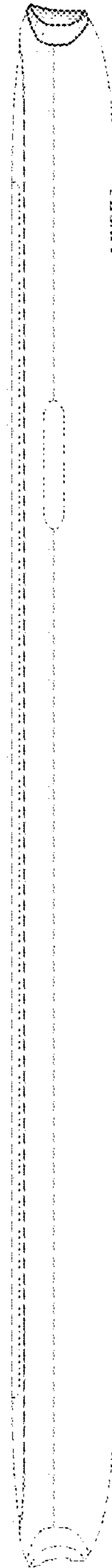

FIG. 6

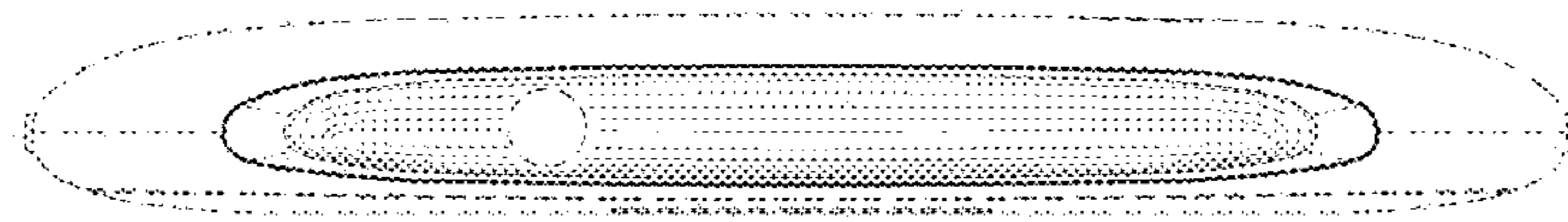

FIG. 7



FIG. 8

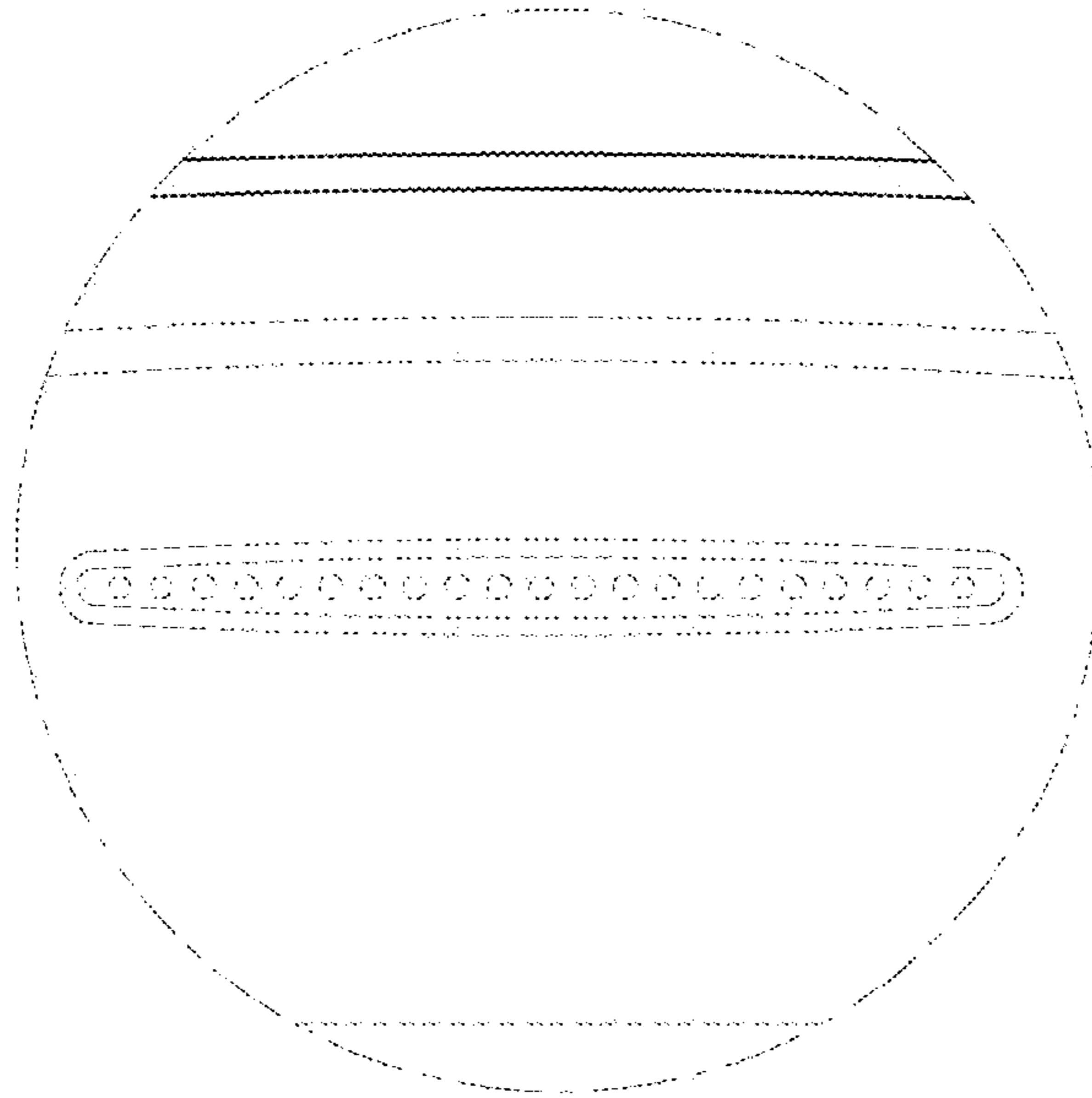

FIG. 9

