

US00D722983S

(12) **United States Design Patent**
Paredes

(10) **Patent No.:** **US D722,983 S**

(45) **Date of Patent:** **** Feb. 24, 2015**

(54) **GARAGE DOOR ACCESSORY**

(71) Applicant: **The Chamberlain Group, Inc.**,
Elmhurst, IL (US)

(72) Inventor: **Apollo Paul Paredes**, Villa Park, IL
(US)

(73) Assignee: **The Chamberlain Group, Inc.**,
Elmhurst, IL (US)

(**) Term: **14 Years**

(21) Appl. No.: **29/478,333**

(22) Filed: **Jan. 3, 2014**

(51) **LOC (10) Cl.** **14-03**

(52) **U.S. Cl.**
USPC **D13/168**

(58) **Field of Classification Search**
CPC H03J 1/0025; H03J 9/00; H03J 9/02;
H03J 9/04; H03J 9/06; H04B 1/202; G05B
11/01; G08C 17/00; G08C 17/02; G08C
19/28; G07C 9/00309; G07C 9/00182; G07C
9/00944; G07C 9/00174; G07C 2009/00222
USPC D13/168; D14/218; D10/104.1, 106.1;
340/4.3, 4.42, 5.7, 5.71, 12.22, 12.23,
340/12.24, 12.29, 12.3, 12.5, 12.55, 13.2,
340/13.21, 13.24; 341/176; 700/17, 65, 83
See application file for complete search history.

(56) **References Cited**

U.S. PATENT DOCUMENTS

D405,424	S	*	2/1999	Winkler et al.	D13/168
D413,867	S	*	9/1999	Mullet et al.	D13/162
D435,835	S	*	1/2001	Steck	D13/168
6,377,173	B1	*	4/2002	Desai	340/426.36
6,525,645	B2	*	2/2003	King et al.	340/5.7
D478,605	S	*	8/2003	Guzman et al.	D13/168
D490,380	S	*	5/2004	Coullahan et al.	D13/168
D494,144	S	*	8/2004	Guzman et al.	D13/168

D495,303	S	*	8/2004	Coullahan et al.	D13/168
D524,295	S	*	7/2006	Jacobson et al.	D14/218
7,215,238	B2	*	5/2007	Buck et al.	340/5.23
D546,295	S	*	7/2007	Marchetto et al.	D13/168
D547,275	S	*	7/2007	Bonnaud	D13/168
D589,497	S	*	3/2009	Andre et al.	D14/218
D592,158	S	*	5/2009	Peterson et al.	D13/168
D613,626	S	*	4/2010	Wang	D10/50
D614,145	S	*	4/2010	Arosio	D13/168
D614,977	S	*	5/2010	Hollnagel et al.	D10/50
D667,382	S	*	9/2012	Cosentino et al.	D13/168
D673,512	S	*	1/2013	Huang	D13/168
D701,496	S	*	3/2014	Namminga	D13/168
D715,228	S	*	10/2014	Lee et al.	D13/158
2013/0063259	A1	*	3/2013	Kramer et al.	340/539.11
2013/0176243	A1	*	7/2013	BianRosa et al.	345/173

* cited by examiner

Primary Examiner — Selina Sikder

(74) *Attorney, Agent, or Firm* — Fitch, Even, Tabin & Flannery, LLP

(57) **CLAIM**

I claim the ornamental design for a garage door accessory, as shown and described.

DESCRIPTION

FIG. 1 is a top perspective view of my new design comprising a garage door accessory;
FIG. 2 is a top view of the garage door accessory of FIG. 1;
FIG. 3 is a bottom view of the garage door accessory of FIG. 1;
FIG. 4 is a right side view of the garage door accessory of FIG. 1;
FIG. 5 is a left side view of the garage door accessory of FIG. 1;
FIG. 6 is a rear view of the garage door accessory of FIG. 1; and,
FIG. 7 is a front view of the garage door accessory of FIG. 1. The broken lines shown in the drawings are for illustrative purposes only and form no part of the claimed design.

1 Claim, 4 Drawing Sheets

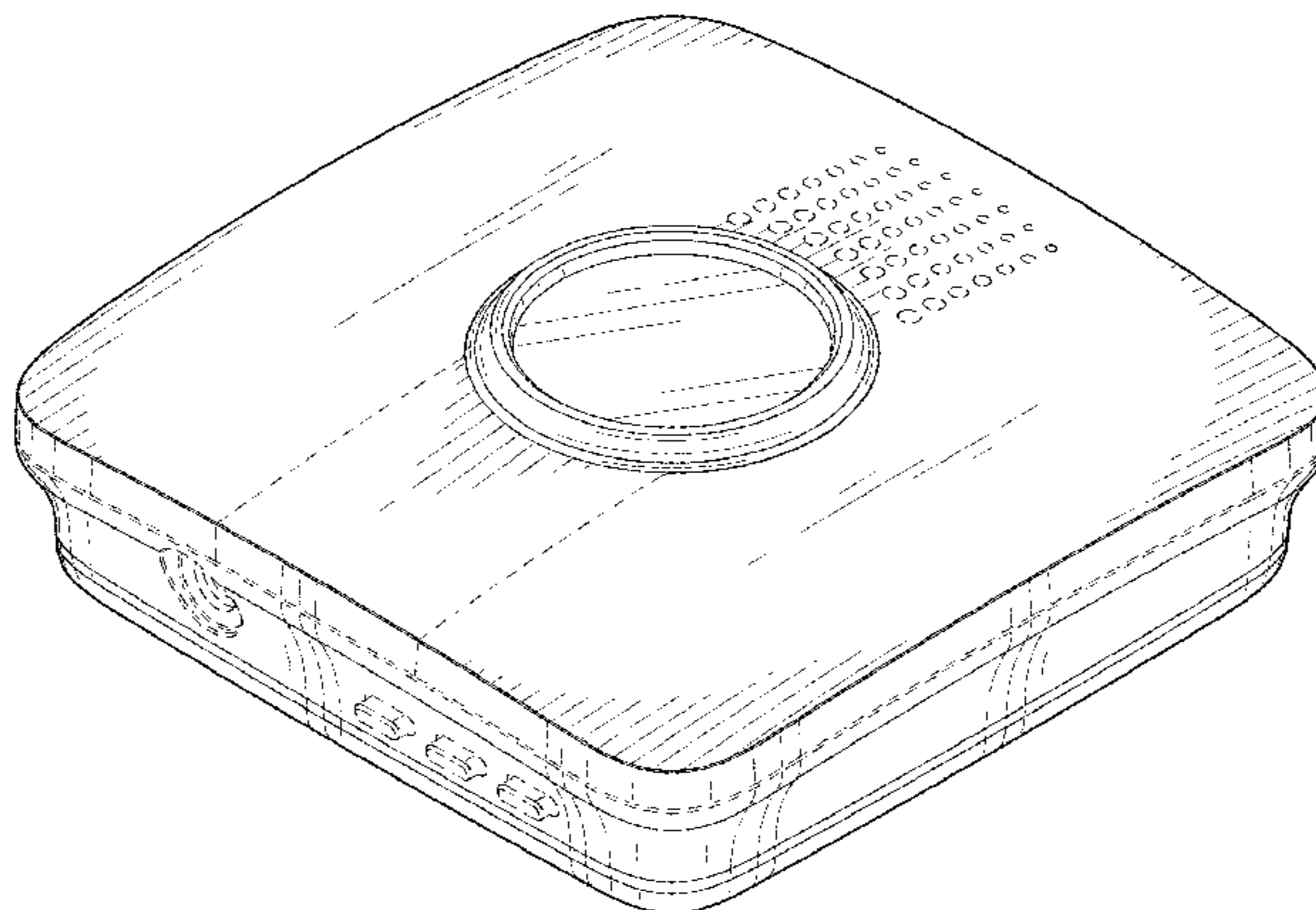

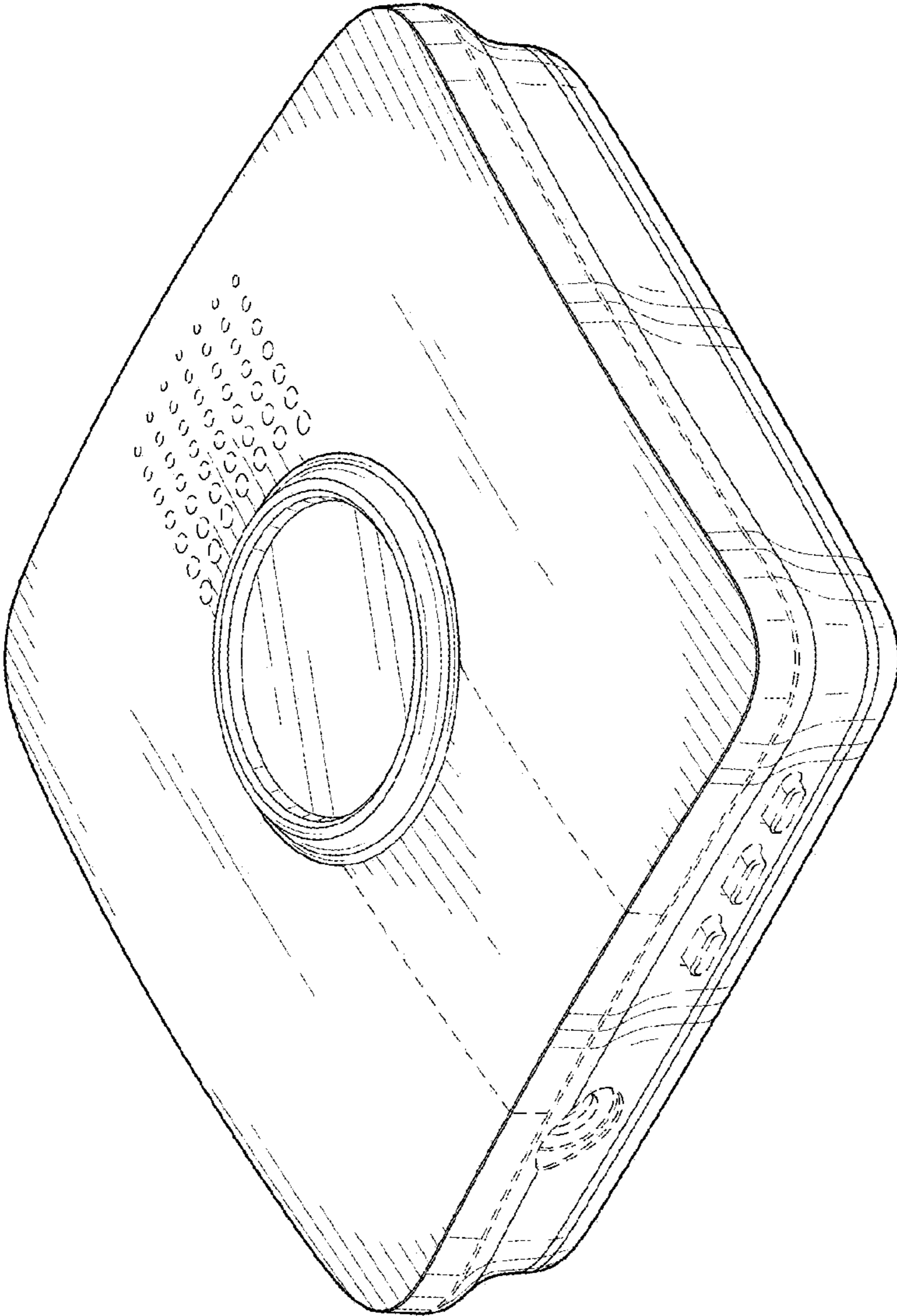

FIG. 1

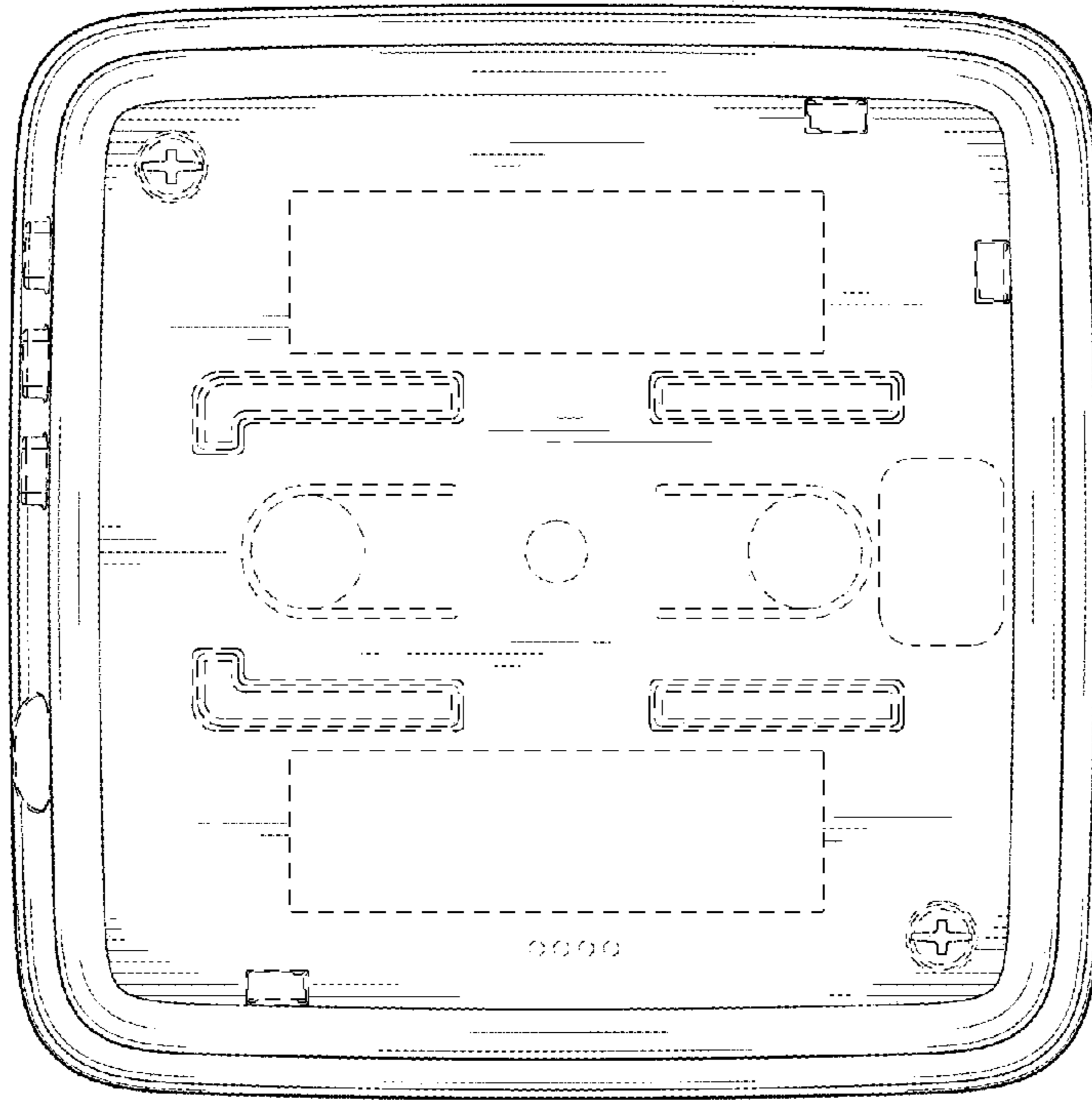

FIG. 3

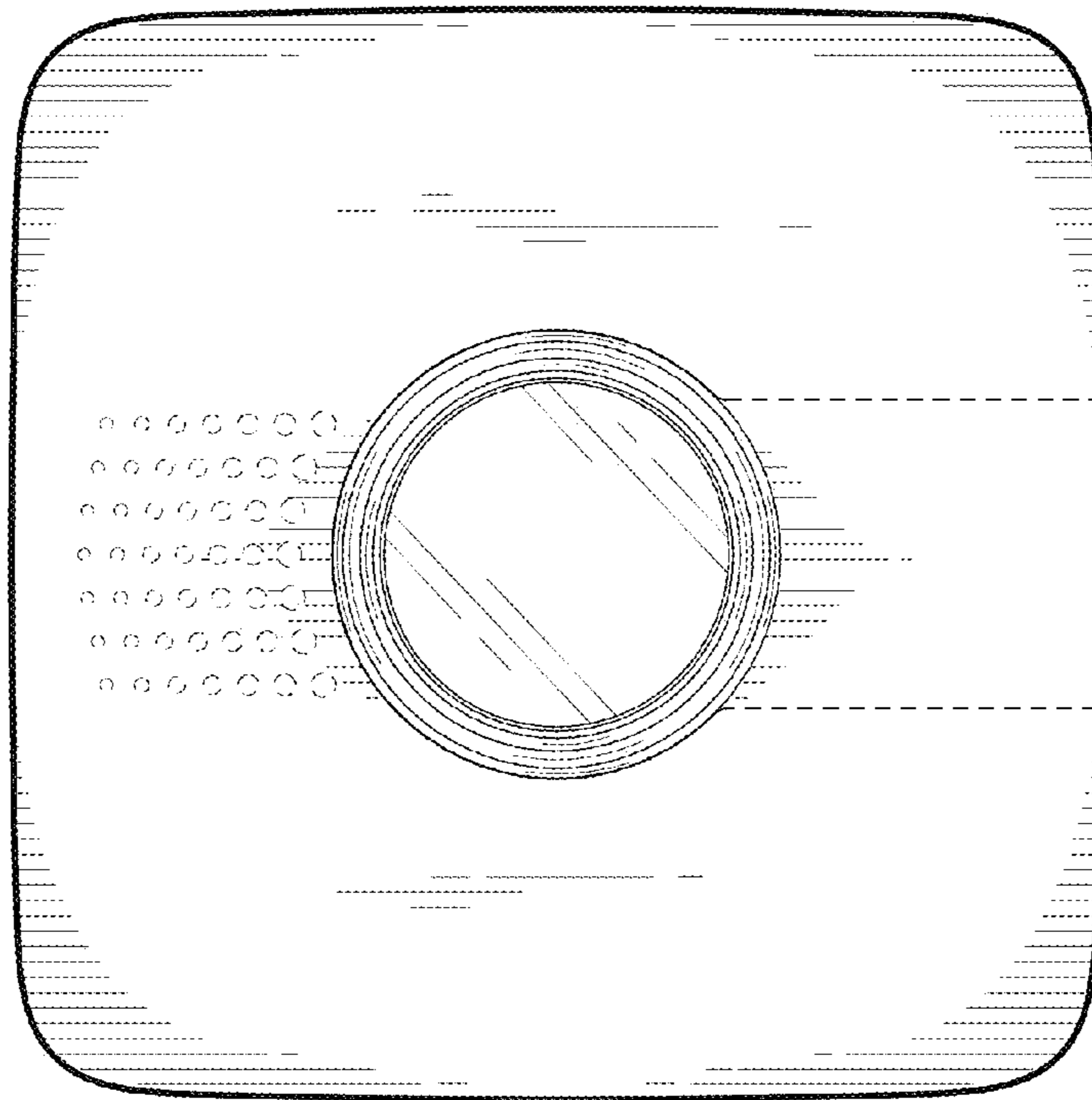

FIG. 2

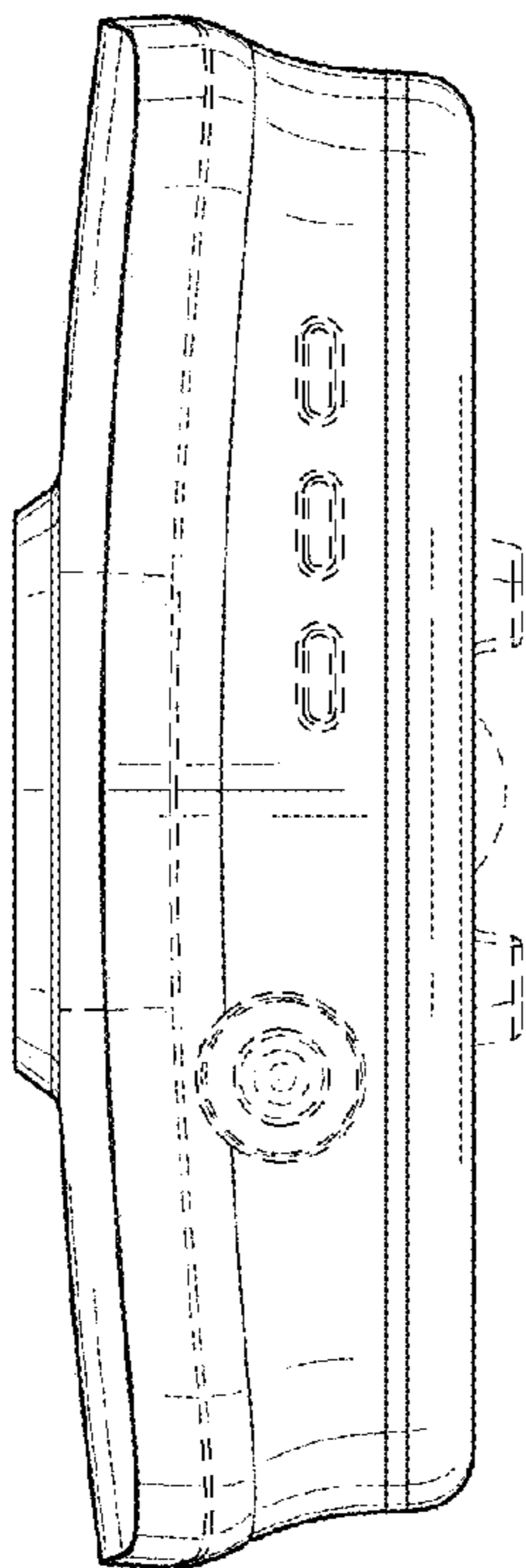

FIG. 4

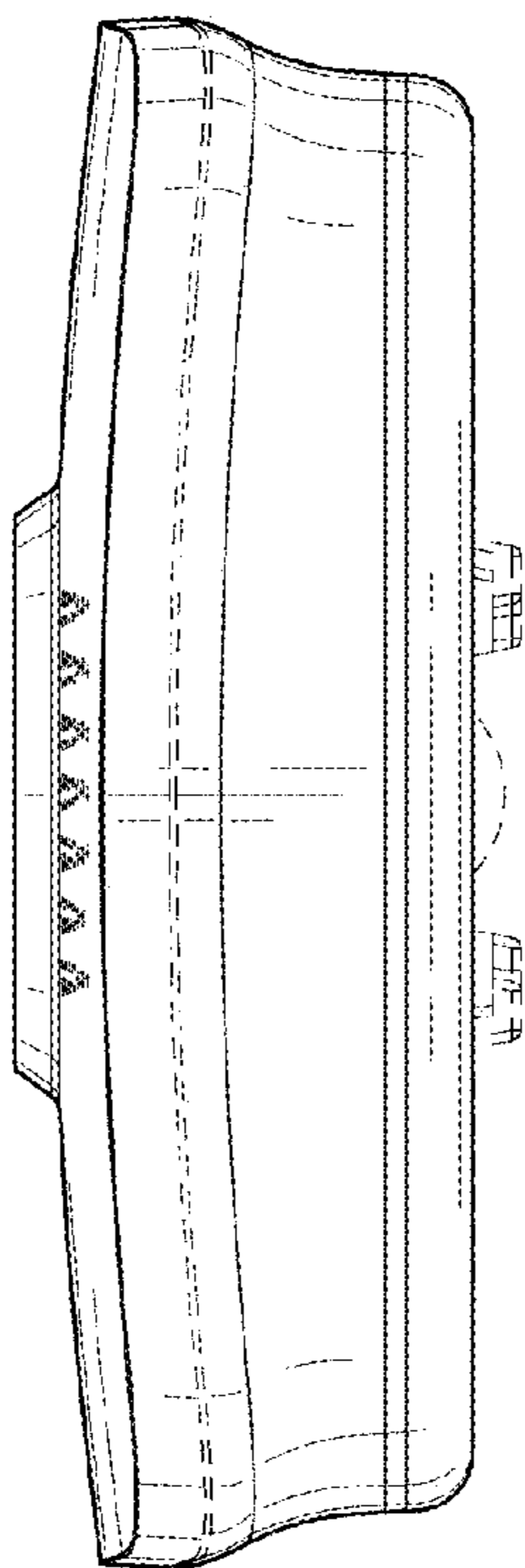

FIG. 5

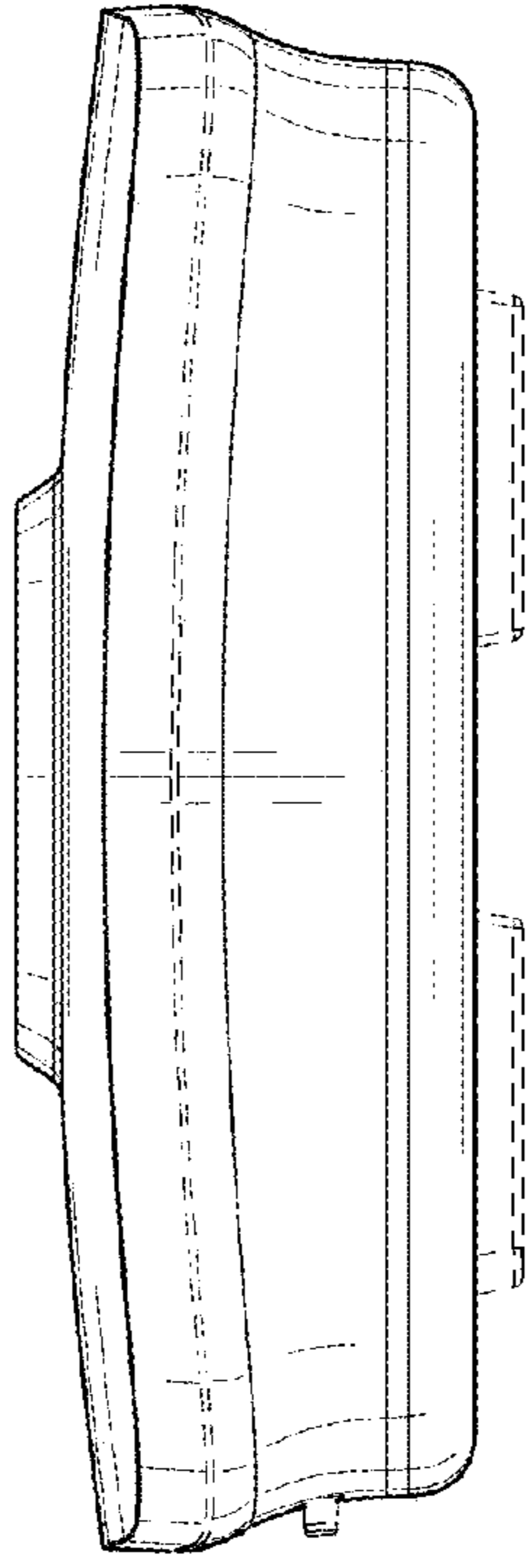

FIG. 6

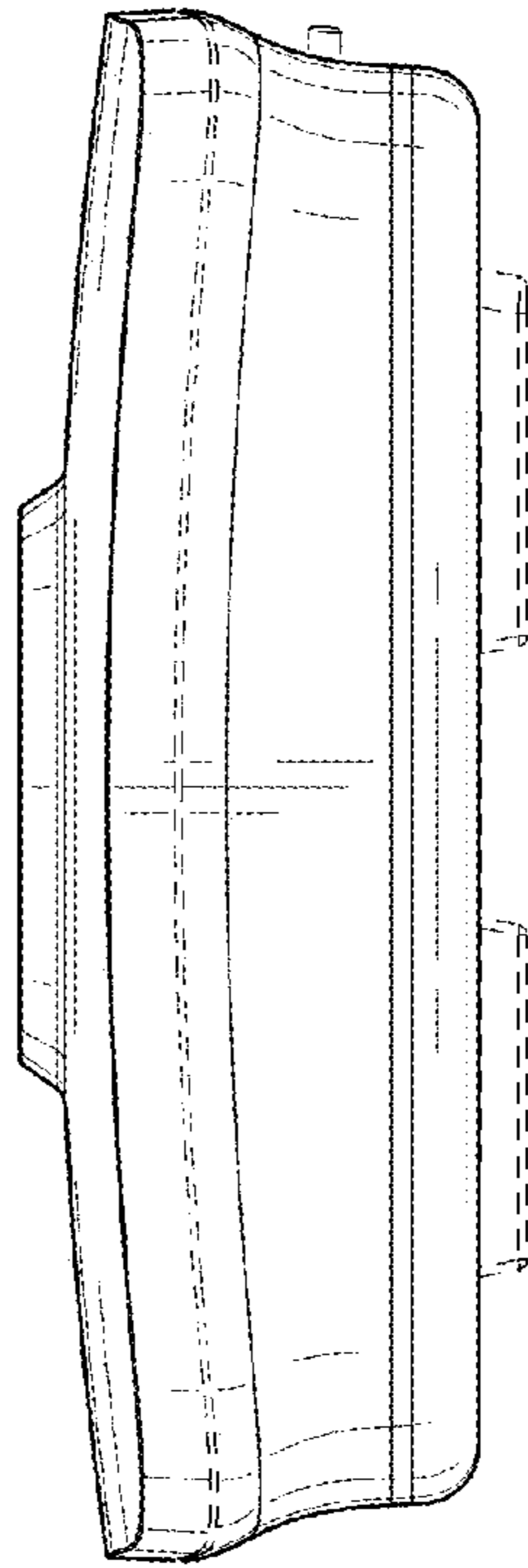

FIG. 7