



US00D722945S

(12) **United States Design Patent**
Richie

(10) **Patent No.:** **US D722,945 S**

(45) **Date of Patent:** **** Feb. 24, 2015**

(54) **SADDLEBAG EXTENSIONS**

(71) Applicant: **John Evans Richie**, Miami, FL (US)

(72) Inventor: **John Evans Richie**, Miami, FL (US)

(**) Term: **14 Years**

(21) Appl. No.: **29/456,925**

(22) Filed: **Jun. 5, 2013**

(51) **LOC (10) Cl.** **12-16**

(52) **U.S. Cl.**
USPC **D12/407**

(58) **Field of Classification Search**

CPC B62J 9/00; B62J 15/00; B62J 9/001;
B62J 15/02; B62K 5/01
USPC 224/413, 430, 419, 440, 447, 431, 423,
224/427, 652, 653, 680, 681, 442;
296/78.1, 37.1; 180/229, 219, 68.3,
180/309, 68.4, 311, 230, 231; 123/520,
123/54.4; 414/809; 280/728.2, 728.3,
280/730.1, 288.4, 279, 280, 304.3;
74/551.1, 551.2, 551.3, 551.4, 551.5,
74/551.6, 551.7, 551.8; D12/186, 410,
D12/114, 409; 190/9; 220/9.1

See application file for complete search history.

(56) **References Cited**

U.S. PATENT DOCUMENTS

D262,103	S	*	12/1981	Beaubien et al.	D12/410
D450,632	S	*	11/2001	Morgan	D12/114
D461,748	S	*	8/2002	Morgan	D12/114
D506,968	S	*	7/2005	Berardino et al.	D12/410
D519,427	S	*	4/2006	Haddock	D12/186
7,207,470	B2	*	4/2007	Akita et al.	224/413
D550,146	S		9/2007	Hanagan		
7,278,560	B2	*	10/2007	Aron	224/413
D579,404	S	*	10/2008	McLaughlin	D12/409
D664,074	S		7/2012	Clarkson		
2004/0118889	A1	*	6/2004	Hamilton	224/413
2004/0149792	A1	*	8/2004	Akita et al.	224/413
2005/0150921	A1	*	7/2005	Schneider	224/413
2006/0162978	A1	*	7/2006	Thompson et al.	180/219

2006/0163302	A1	*	7/2006	Knoch et al.	224/413
2006/0261110	A1	*	11/2006	Aron	224/413
2007/0063491	A1	*	3/2007	Horiuchi et al.	280/728.2
2008/0083801	A1	*	4/2008	Knoch et al.	224/413
2009/0001114	A1	*	1/2009	Sonnetag et al.	224/413
2011/0221221	A1	*	9/2011	Inoue et al.	296/37.1
2014/0069974	A1	*	3/2014	Kaczowski et al.	224/413

* cited by examiner

Primary Examiner — Eric Goodman

Assistant Examiner — Ryan Harvey

(74) *Attorney, Agent, or Firm* — Tracy Jong Law Firm;
Tracy P. Jong; Cheng Ning Jong

(57) **CLAIM**

The ornamental design for saddlebag extensions, as shown and described.

DESCRIPTION

FIG. 1 is a top right rear perspective view of a motorcycle, drawn in broken lines, showing the ornamental design of the exterior surfaces of the saddlebag extensions in use;

FIG. 2 is a right elevation view of the saddlebag extensions shown in use with a saddlebag of a motorcycle drawn in broken lines;

FIG. 3 is a top right rear perspective view of the saddlebag extensions shown in use with saddlebags of a motorcycle drawn in broken lines;

FIG. 4 is a top right rear perspective view of the saddlebag extensions, depicting the left and right saddlebag extensions as they are removed from their respective saddlebags drawn in broken lines;

FIG. 5 is a front elevation view of the saddlebag extensions;

FIG. 6 is a right elevation view of the right saddlebag extension;

FIG. 7 is a left elevation view thereof;

FIG. 8 is a bottom plan view of the saddlebag extensions;

FIG. 9 is a rear elevation view thereof; and,

FIG. 10 is a front elevation view thereof.

The single dashed lines represent parts of a motorcycle and form no part of the claim.

1 Claim, 5 Drawing Sheets

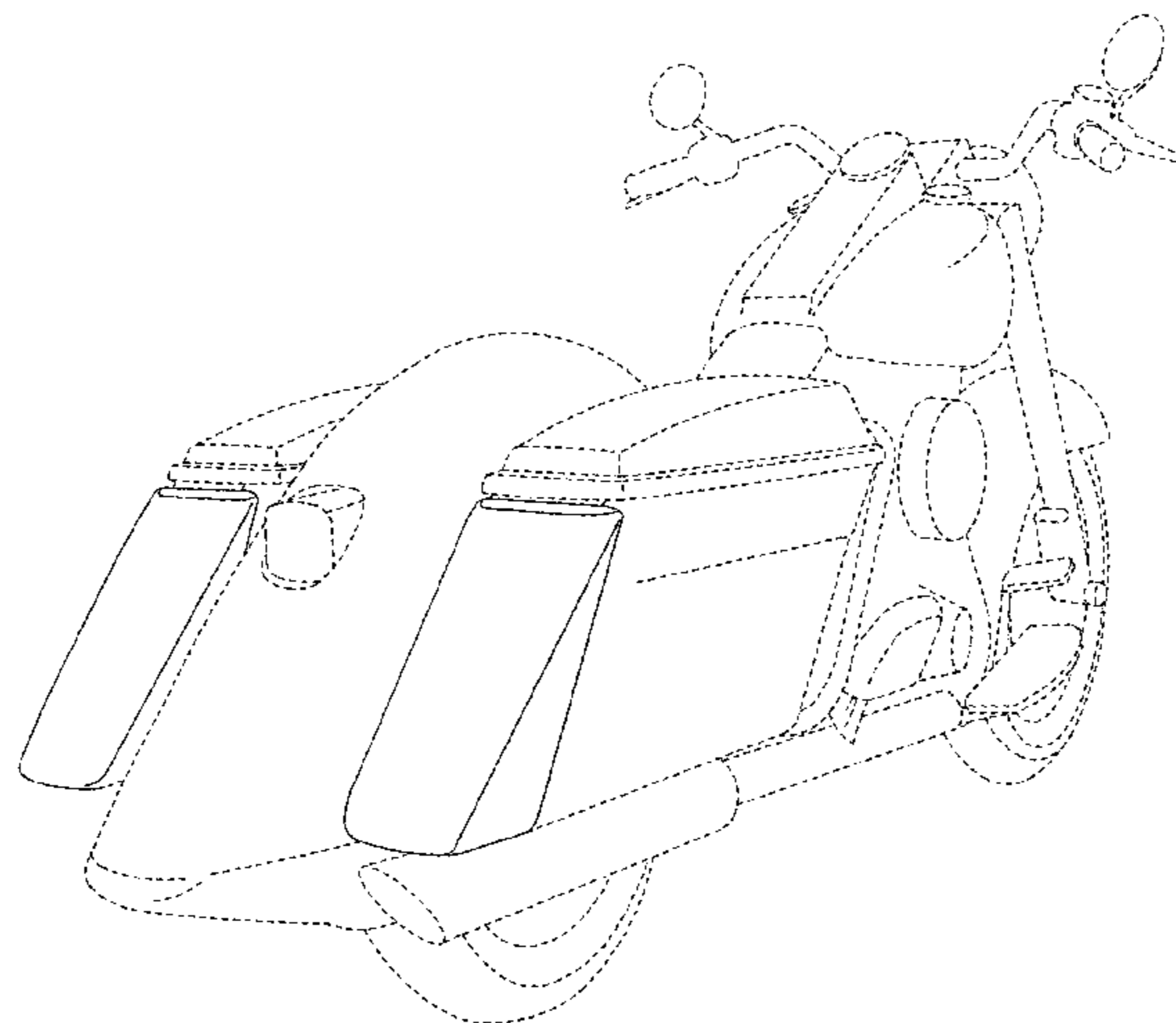

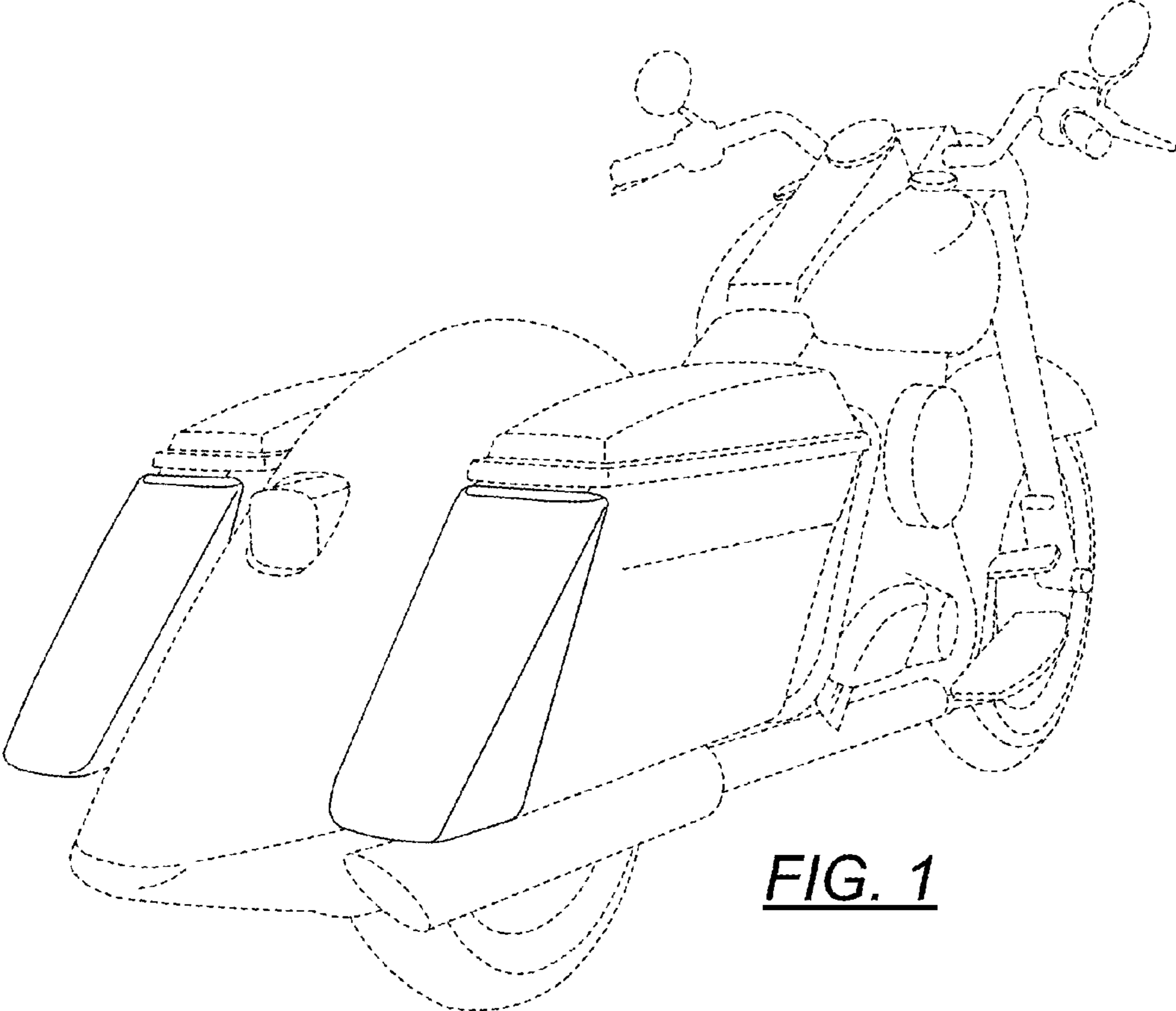

FIG. 1

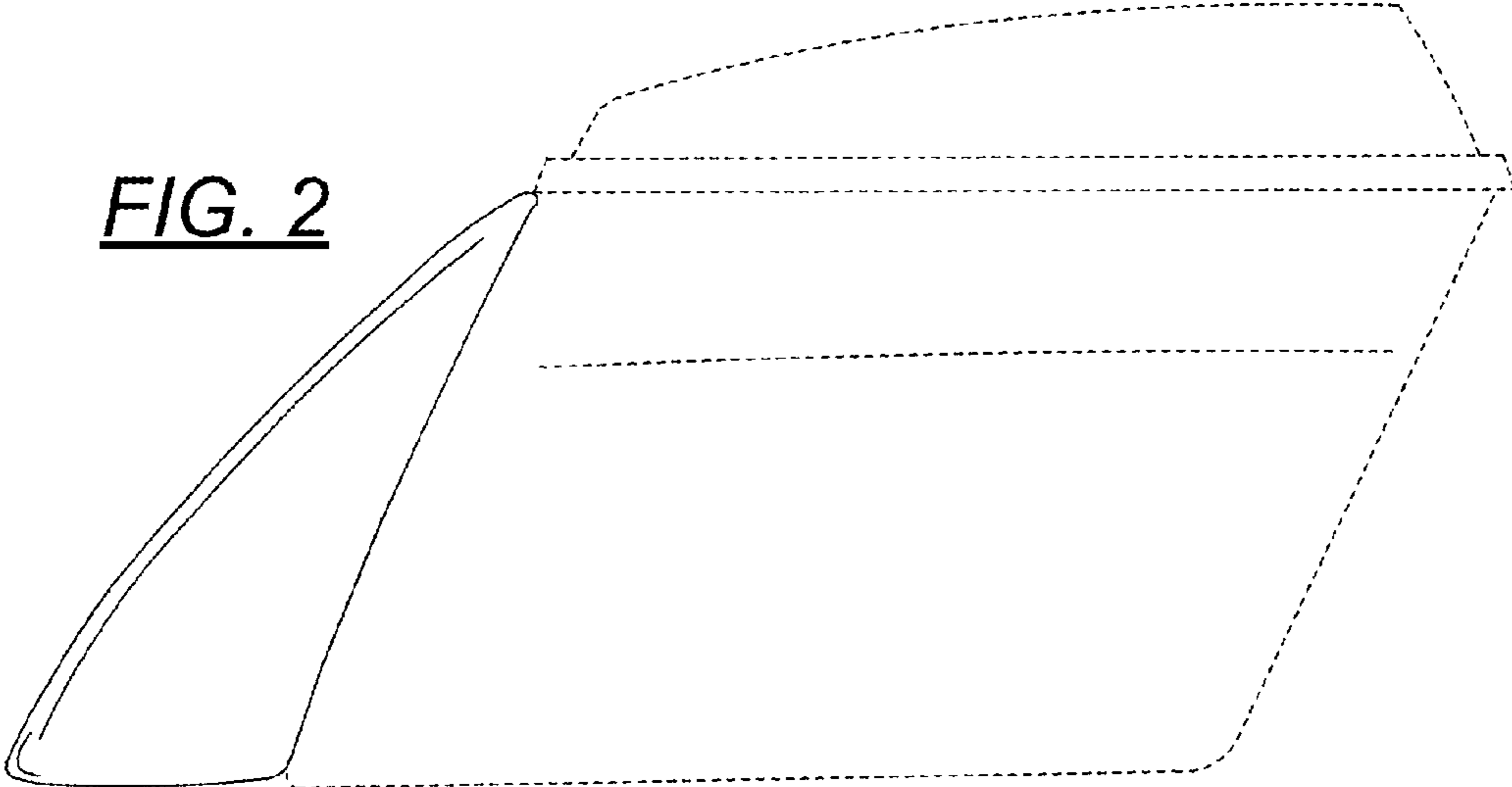

FIG. 2

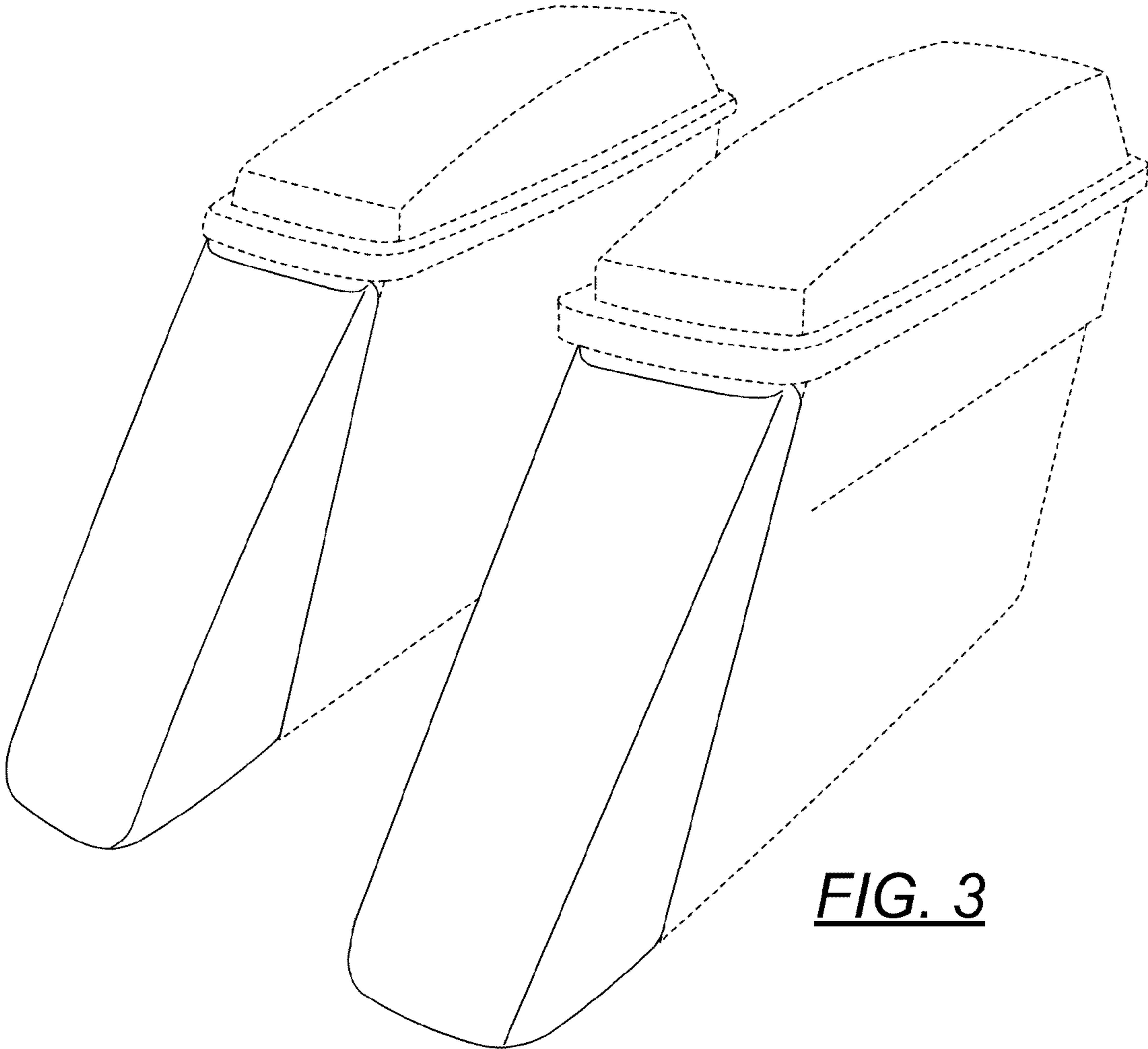

FIG. 3

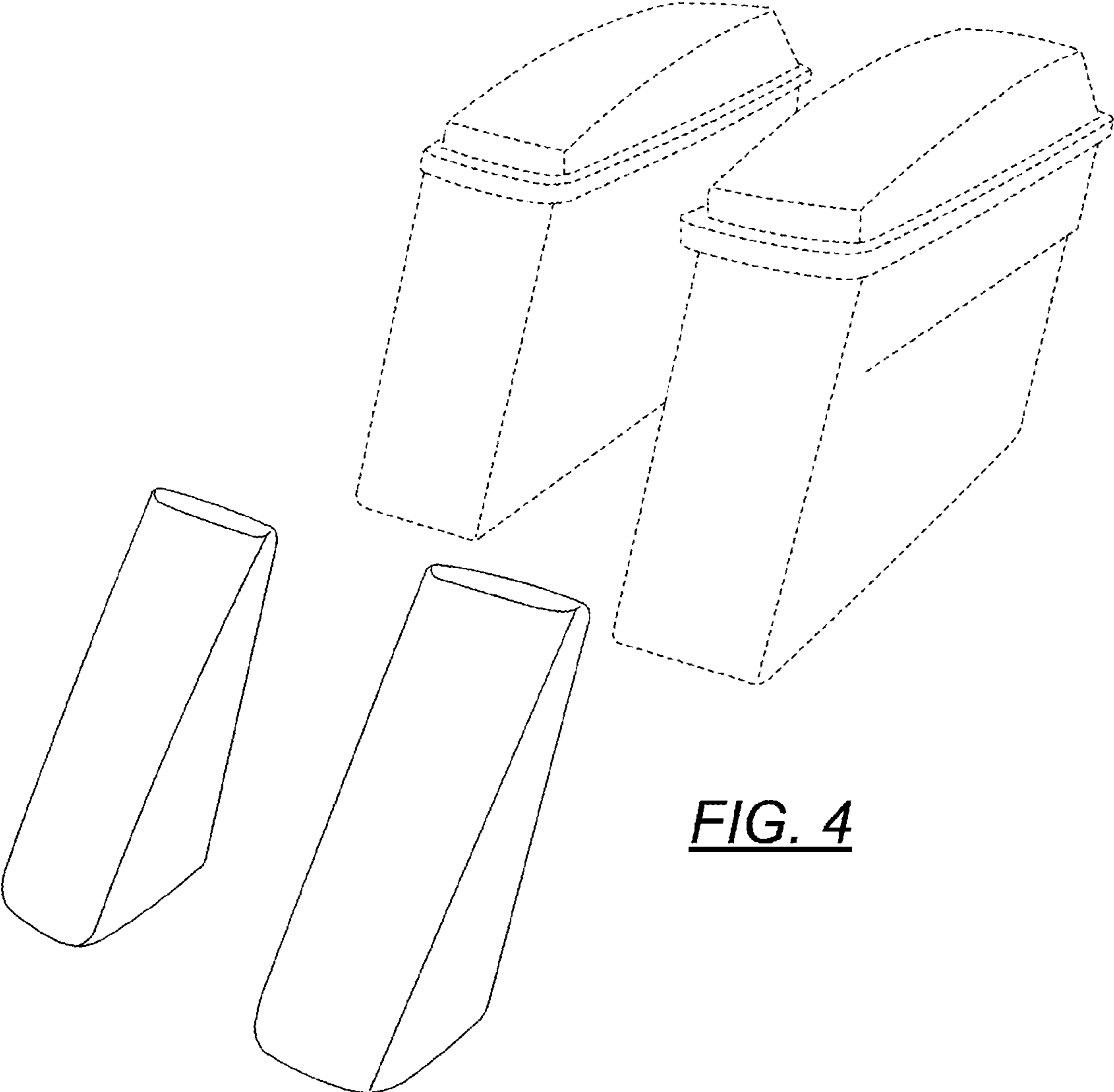

FIG. 4

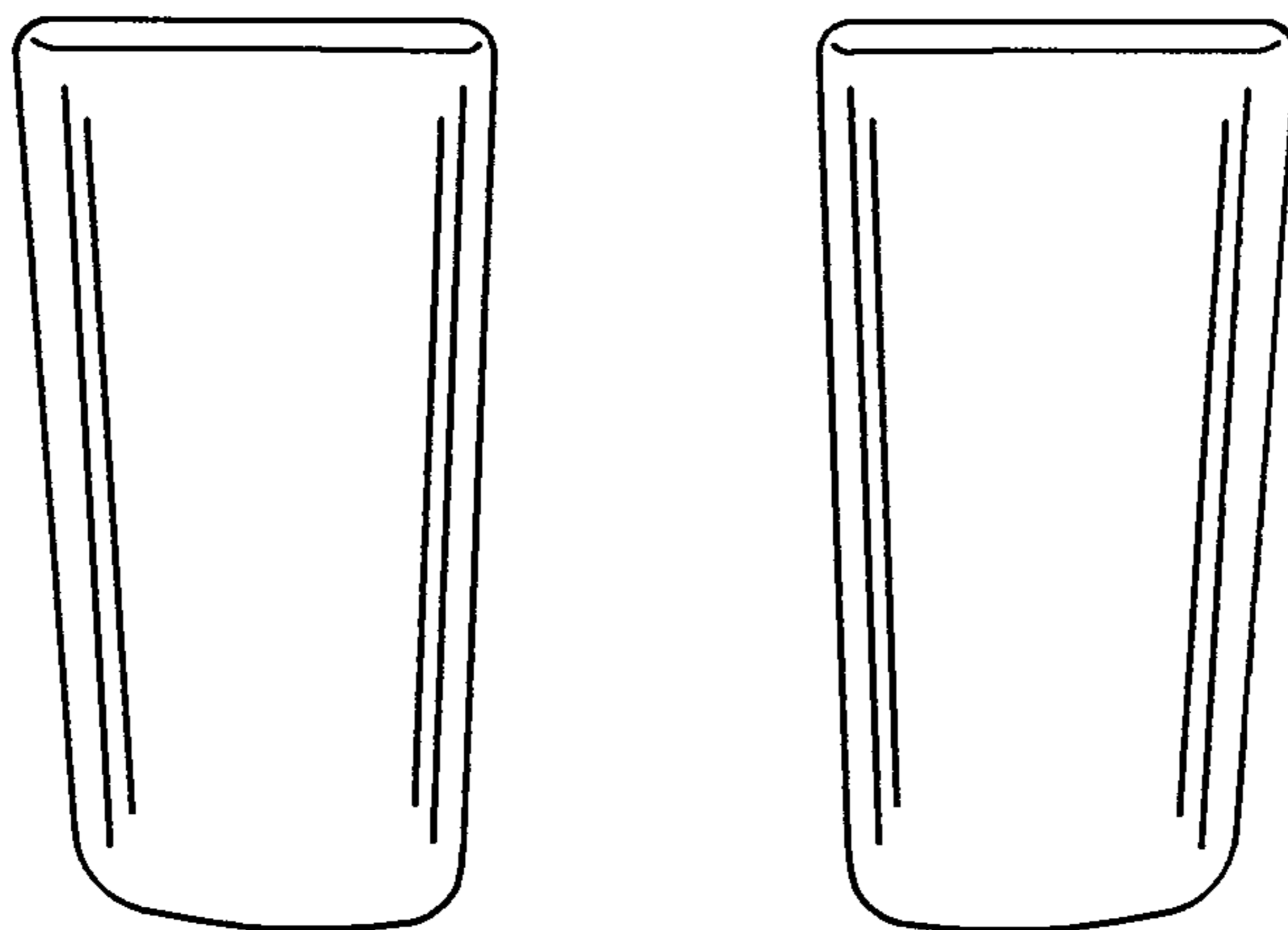

FIG. 5

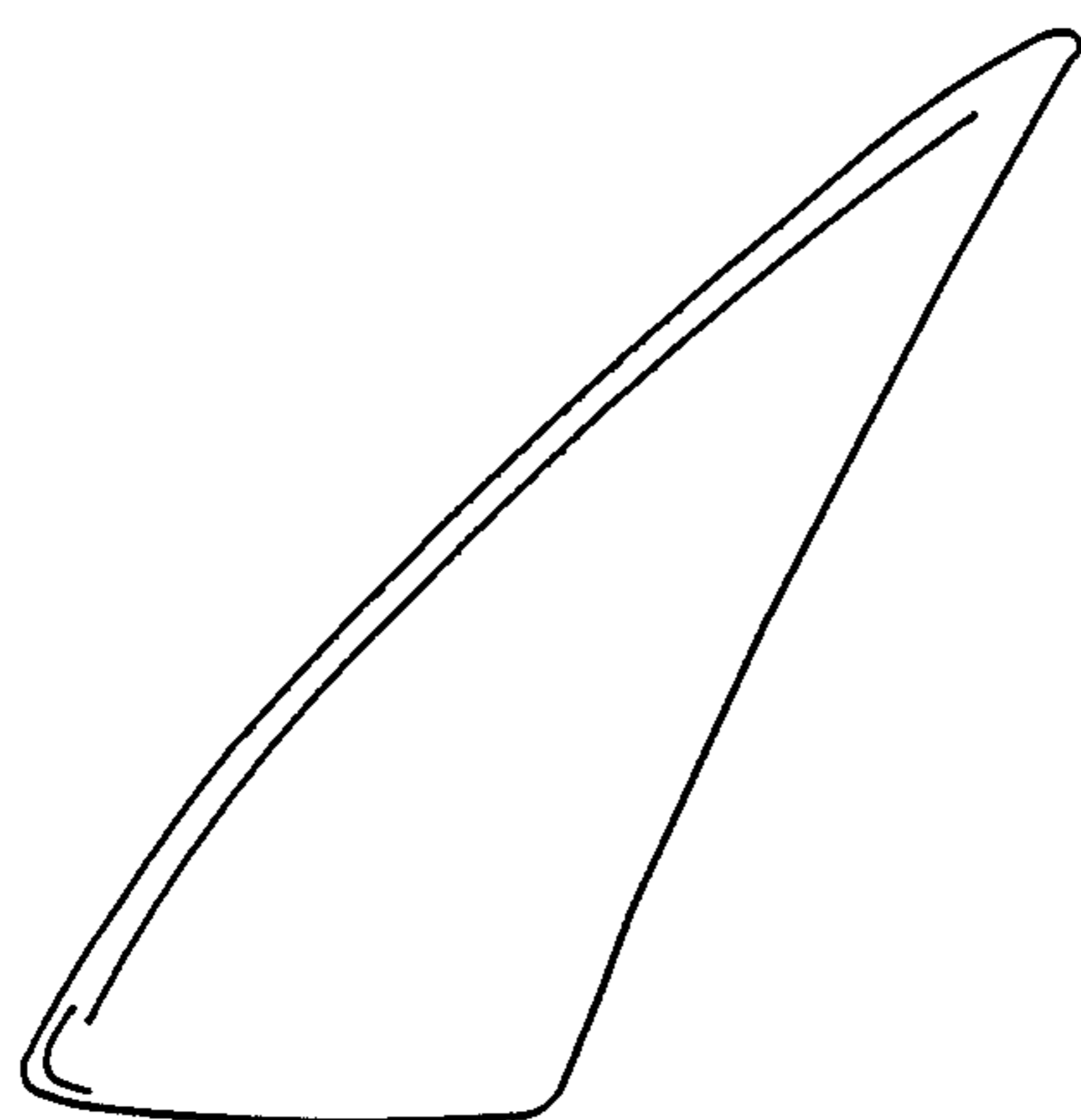

FIG. 6

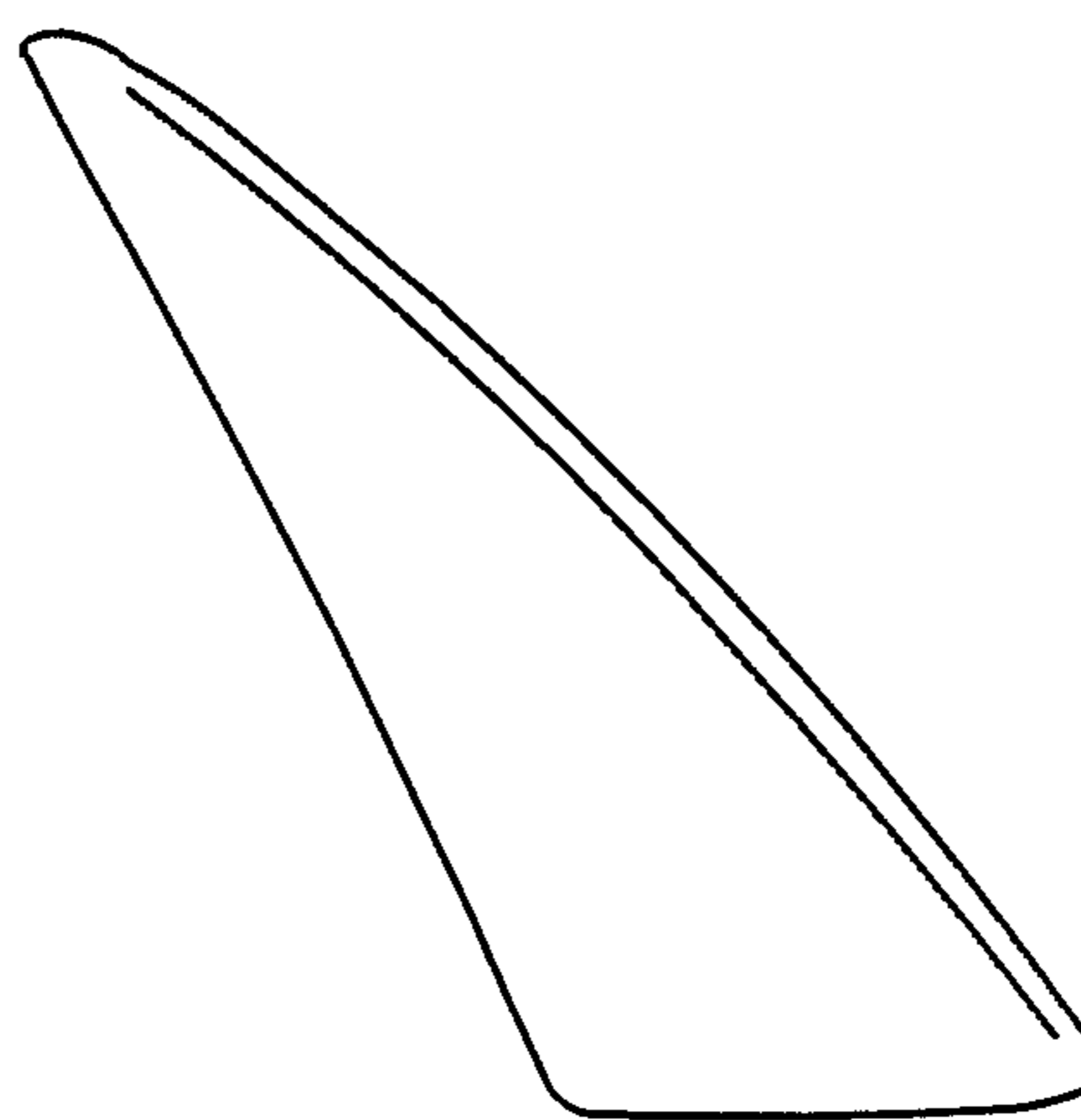

FIG. 7

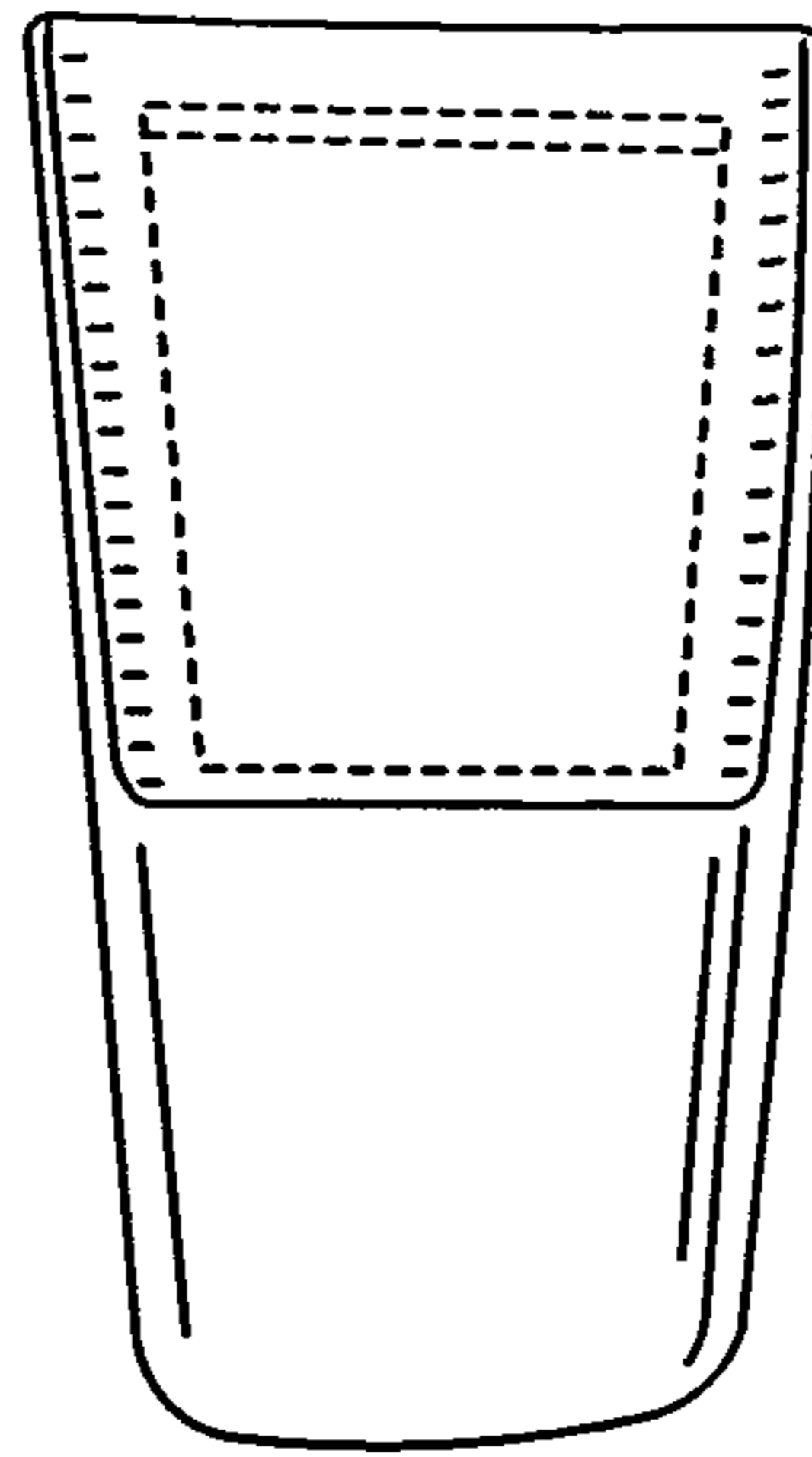
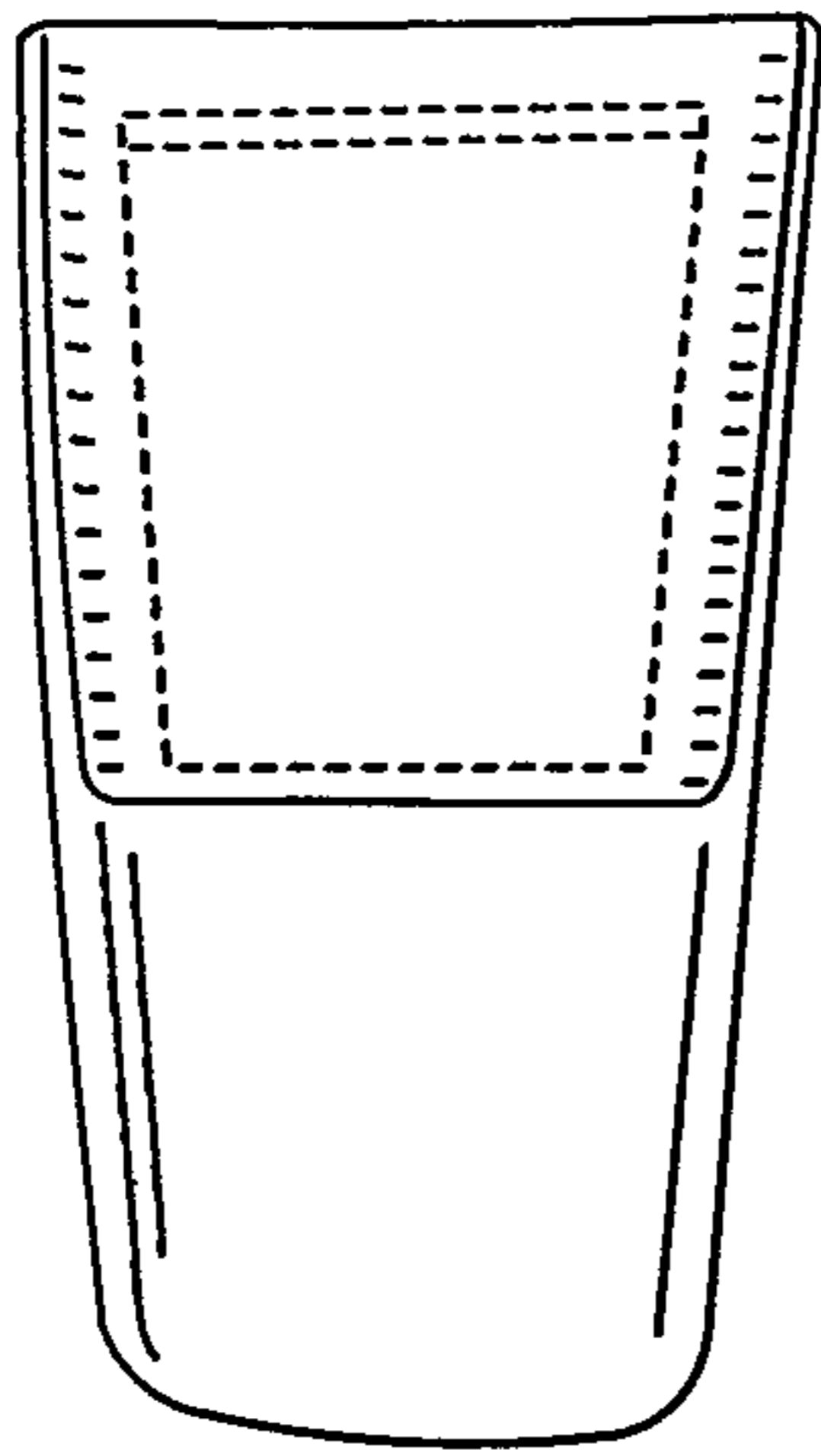

FIG. 8

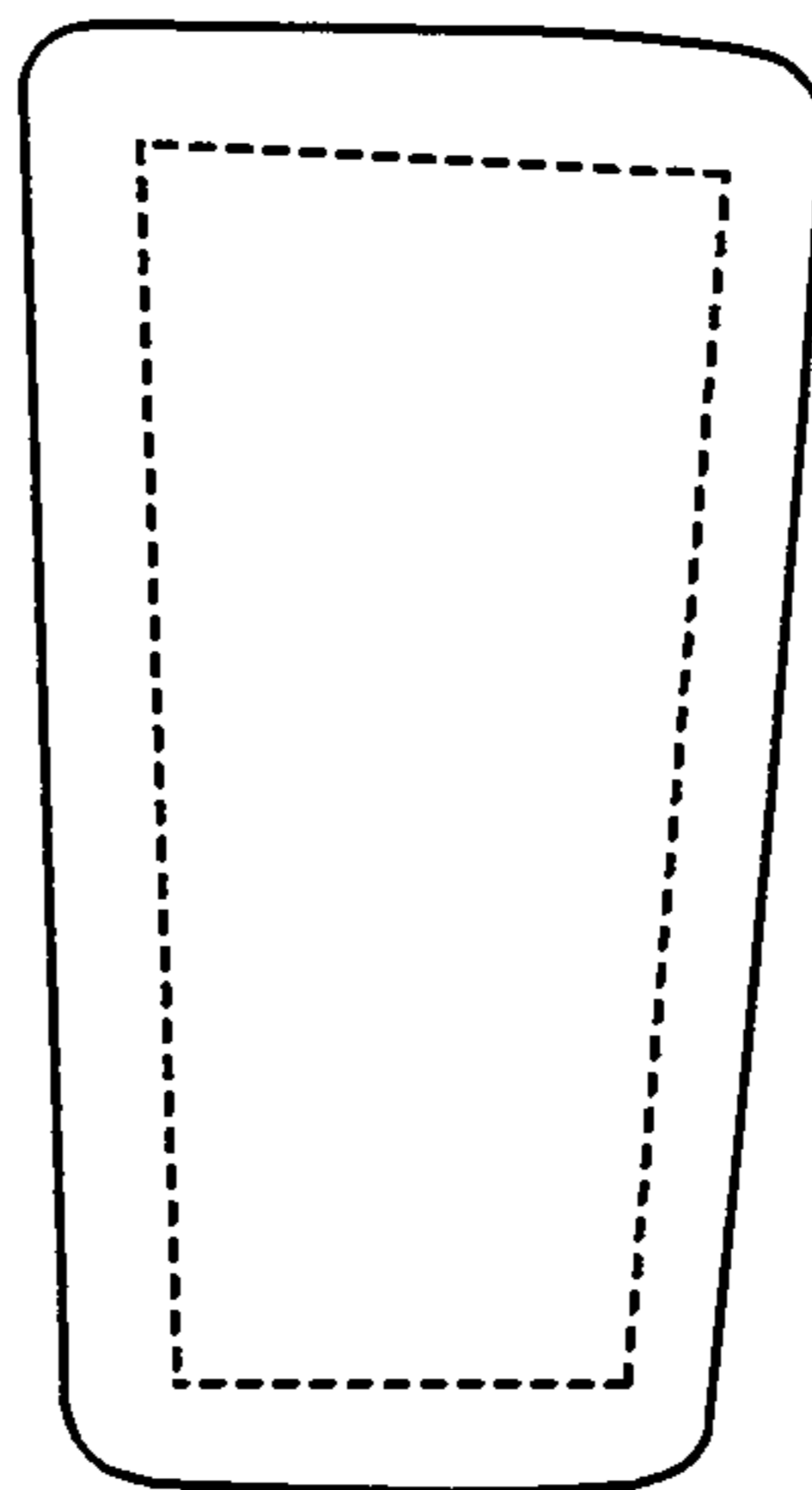
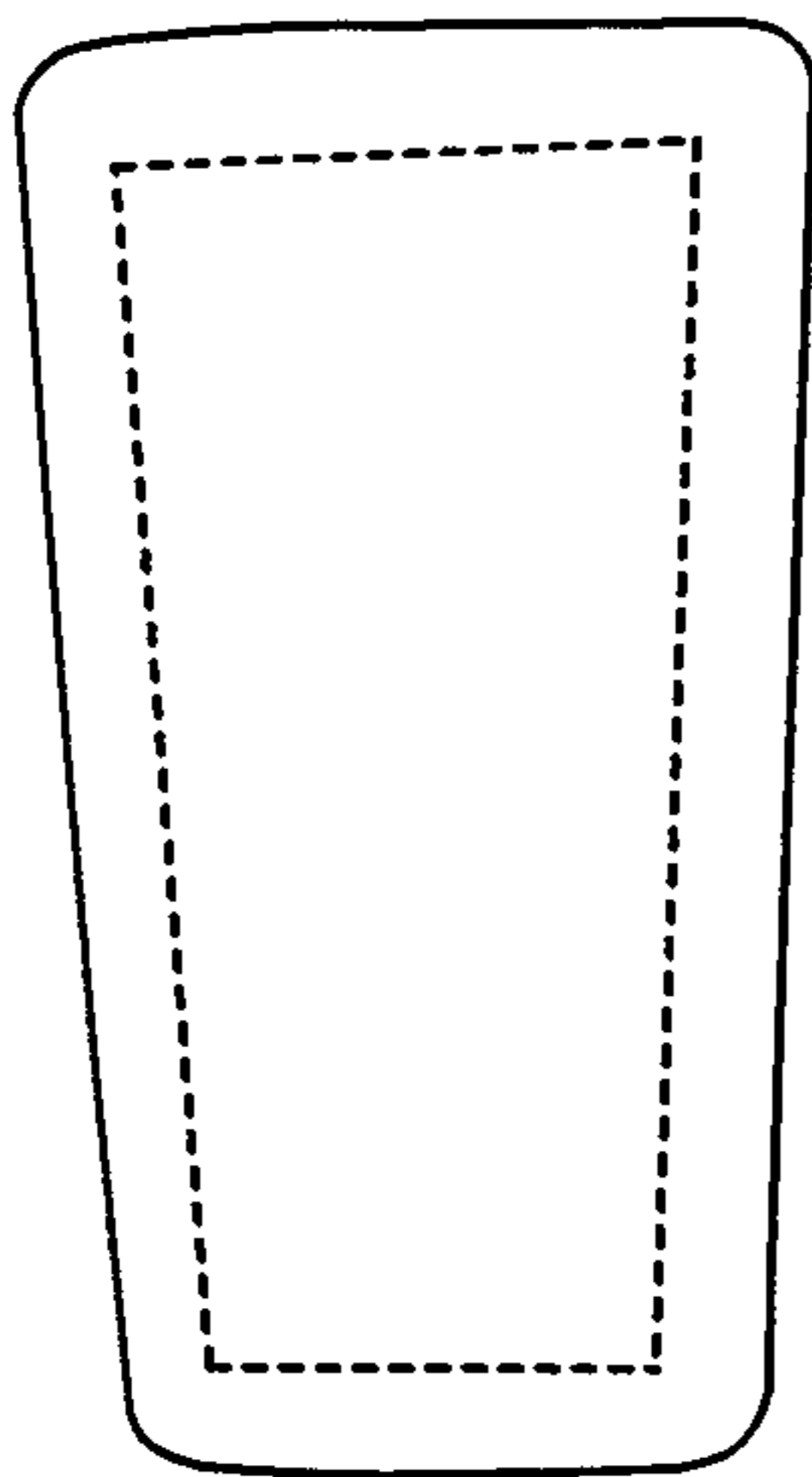

FIG. 9

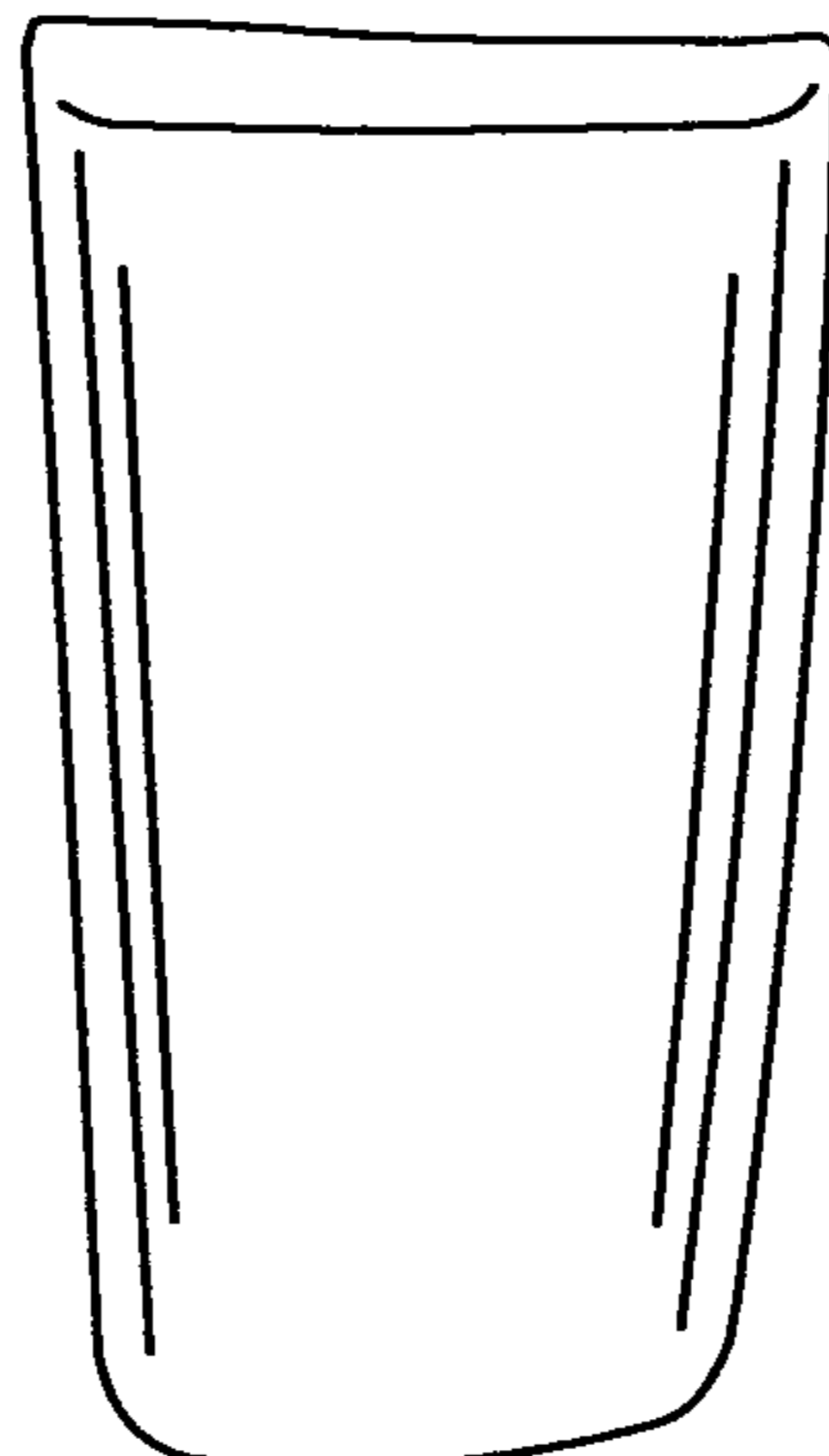
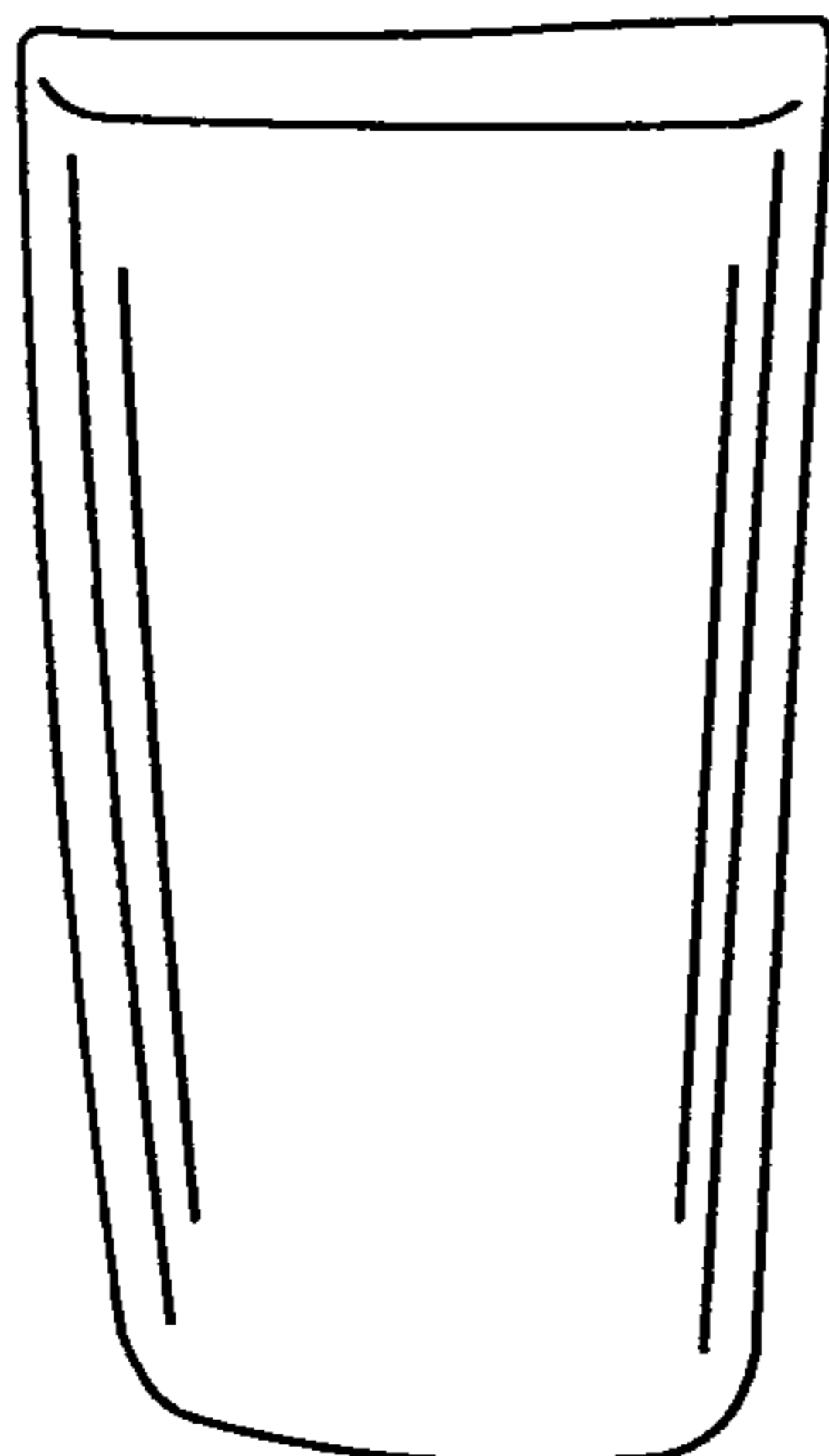

FIG. 10