



US00D722837S

(12) **United States Design Patent**
Miksovsky et al.

(10) **Patent No.:** **US D722,837 S**

(45) **Date of Patent:** **** Feb. 24, 2015**

(54) **SPOON AND FORK UTENSIL SET**

(71) Applicant: **Humangear, Inc.**, San Francisco, CA
(US)

(72) Inventors: **Christopher A. Miksovsky**, San Francisco, CA (US); **Clint N. Slone**, San Francisco, CA (US); **Evelyne Chaubert**, San Francisco, CA (US); **Charlie Nghiem**, Oakland, CA (US)

(73) Assignee: **humangear, Inc.**, San Francisco, CA
(US)

(**) Term: **14 Years**

(21) Appl. No.: **29/484,447**

(22) Filed: **Mar. 10, 2014**

(51) **LOC (10) Cl.** **07-03**

(52) **U.S. Cl.**
USPC **D7/643**; D7/644; D7/653

(58) **Field of Classification Search**
CPC A01B 1/20; A01B 1/22; A01D 9/02; A01D 9/04; A01D 9/06; A47G 21/00; A47G 21/004; A47G 21/005; A47G 21/02; A47G 21/023; A47G 21/04; A47G 21/06; A47G 21/08; A47J 43/28; A47J 43/281; A47J 43/282; A61F 13/10; A61J 7/0023; B25G 1/00; B25G 1/01; B25G 1/02; B25G 3/00; B26B 3/00; B26B 3/02; B26B 11/00; B26B 11/006; B65D 75/56; B65D 75/563; B65D 75/566; B67B 7/00; B67B 7/38; B67B 7/724; B67B 7/73

USPC D7/368, 401.2, 642–645, 649–664, 669, D7/675–677, 683, 688–689, 691–692; D8/107, 300–301; D22/117–118; 16/110.1, 407, 430; 30/1, 137, 30/142–150, 322–329, 340, 342–345, 30/408; 294/25–26, 49, 55.5, 57

See application file for complete search history.

(56) **References Cited**

U.S. PATENT DOCUMENTS

398,264	A	*	2/1889	Kisner	30/150
D30,129	S	*	2/1899	Torade	D7/644
849,098	A	*	4/1907	Aufrichtig	30/408
854,745	A	*	5/1907	King	30/150
D60,369	S	*	2/1922	Quandee et. al.	D7/644
2,318,129	A	*	5/1943	Torode	30/147
D249,926	S	*	10/1978	Wong	D7/644
D269,060	S	*	5/1983	Creamer	
D325,855	S	*	5/1992	Rea, Sr.	D7/692
D342,422	S	*	12/1993	Sanford	D7/644
5,845,403	A	*	12/1998	Nivin	30/147
D414,988	S	*	10/1999	Santini	
D530,985	S	*	10/2006	Evans	
D535,857	S	*	1/2007	Bristow	D7/644
D575,593	S	*	8/2008	Svartström	
D608,602	S	*	1/2010	Davies et al.	D7/644
D633,344	S	*	3/2011	Nordwall	D7/644
2014/0026425	A1	*	1/2014	Kim	

OTHER PUBLICATIONS

Alite, Cloverware Lite, <http://shop.alitedesigns.com/cloverware-lite.html>, downloaded on Mar. 6, 2014.

Alite, Cloverware 2.0, <http://shop.alitedesigns.com/cloverware-538.html>, downloaded on Mar. 6, 2014.

Guyot, Microbites™, <https://www.guyotdesigns.com/product-microbites/>, downloaded on Mar. 6, 2014.

Guyot, Utensils, <https://www.guyotdesigns.com/utensils/>, downloaded on Mar. 6, 2014.

* cited by examiner

Primary Examiner — Ricky Pham

(74) *Attorney, Agent, or Firm* — Beyer Law Group LLP

(57) **CLAIM**

We claim the ornamental design for a spoon and fork utensil set, substantially as shown and described.

DESCRIPTION

FIG. 1 is a front perspective view of a spoon and fork in accordance with the present design coupled in a nested position.

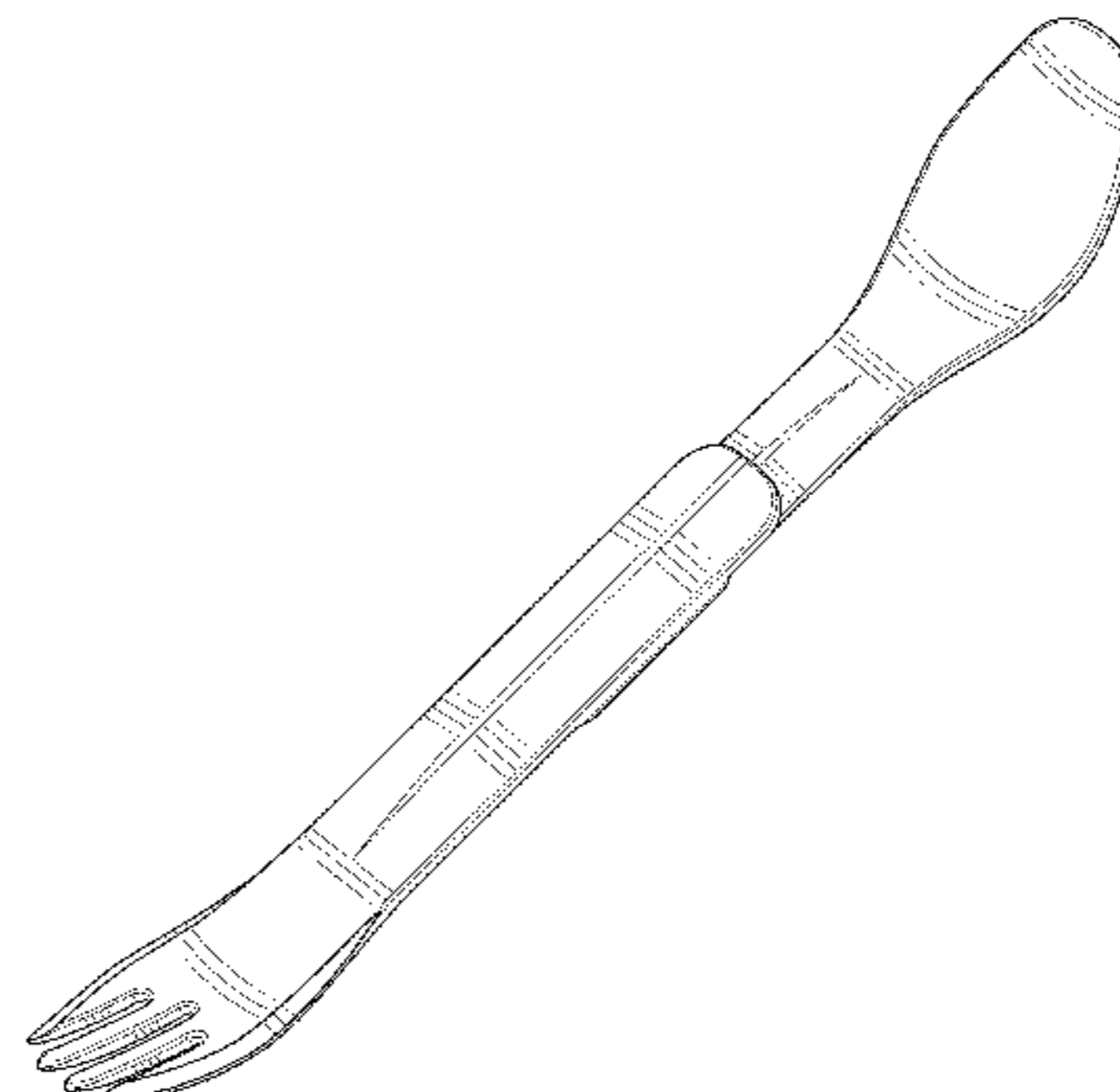
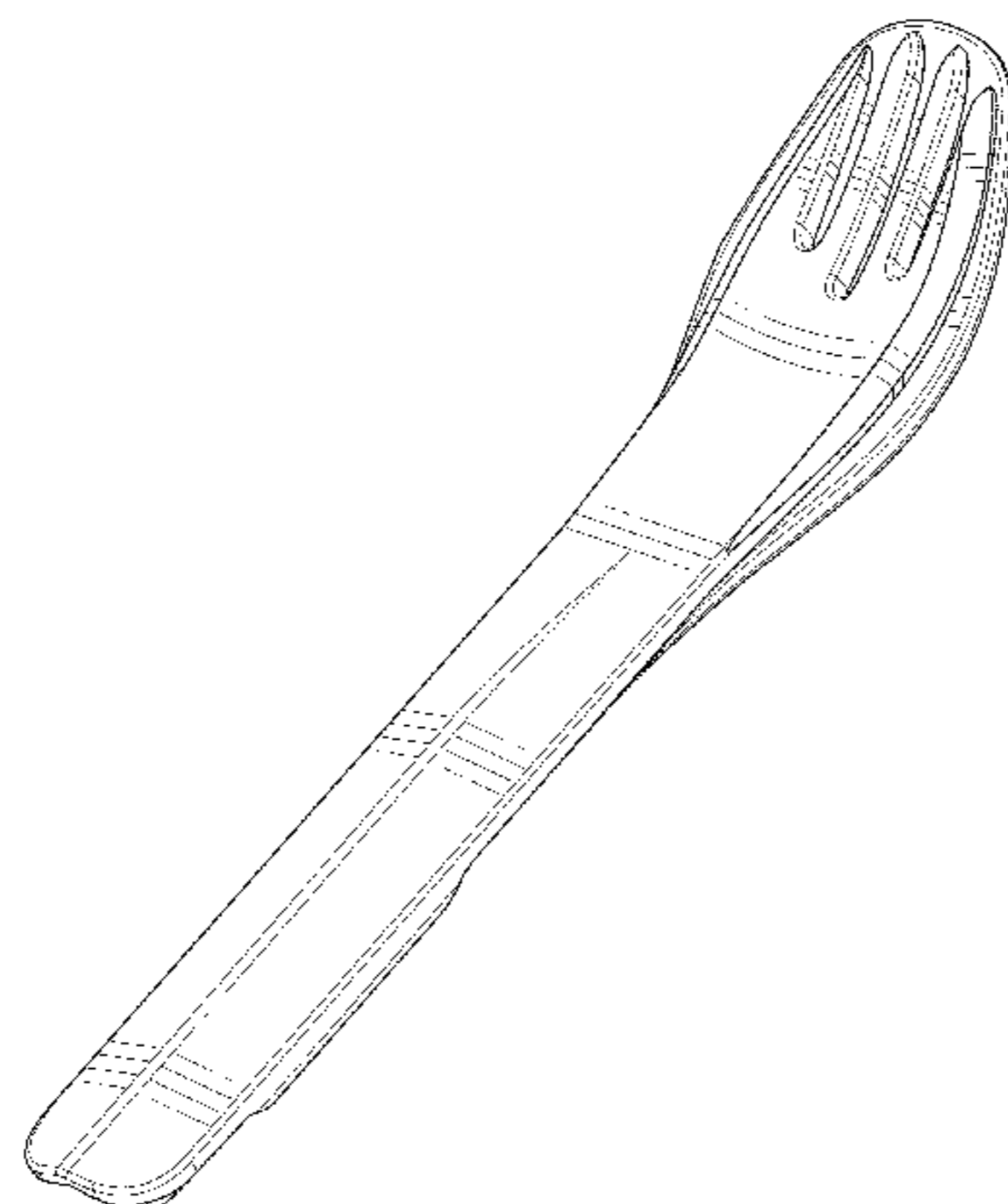

FIG. 2 is a back perspective view of the spoon and fork coupled in the nested position.

FIG. 3 is a top plan view of the spoon and fork in the nested position.

FIG. 4 is a bottom plan view of the spoon and fork in the nested position.

FIG. 5 is a right side elevational view of the spoon and fork in the nested position.

FIG. 6 is a left side elevational view of the spoon and fork in the nested position.

FIG. 7 is an enlarged upper end elevational view of the spoon and fork in the nested position.

FIG. 8 is an enlarged lower end elevational view of the spoon and fork in the nested position.

FIG. 9 is a top perspective view of the fork alone.

FIG. 10 is a bottom perspective view of the fork.

FIG. 11 is a top plan view of the fork.

FIG. 12 is a bottom plan view of the fork.

FIG. 13 is a right side elevational view of the fork.

FIG. 14 is a left side elevational view of the fork.

FIG. 15 is an enlarged upper end elevational view of the fork.

FIG. 16 is an enlarged lower end elevational view of the fork.

FIG. 17 is a top perspective view of the spoon alone.

FIG. 18 is a bottom perspective view of the spoon.

FIG. 19 is a top plan view of the spoon.

FIG. 20 is a bottom plan view of the spoon.

FIG. 21 is a right side elevational view of the spoon.

FIG. 22 is a left side elevational view of the spoon.

FIG. 23 is an enlarged upper end elevational view of the spoon.

FIG. 24 is an enlarged lower end elevational view of the spoon.

FIG. 25 is a top perspective view of the spoon and fork interlocked in an extended position.

FIG. 26 is a bottom perspective view of the spoon and fork interlocked in the extended position.

FIG. 27 is a top plan view of the spoon and fork in the extended position.

FIG. 28 is a bottom plan view of the spoon and fork in the extended position.

FIG. 29 is a right side elevational view of the spoon and fork in the extended position.

FIG. 30 is a left side elevational view of the spoon and fork in the extended position.

FIG. 31 is an enlarged upper end elevational view of the spoon and fork in the extended position; and,

FIG. 32 is an enlarged lower end elevational view of the spoon and fork in the extended position.

The broken lines are shown for illustrative purposes only and form no part of the claimed design.

The spoon and fork may be used individually; they may be coupled together in the nested position for compact storage; or they may be coupled together in the extended position to create a longer utensil.

1 Claim, 32 Drawing Sheets

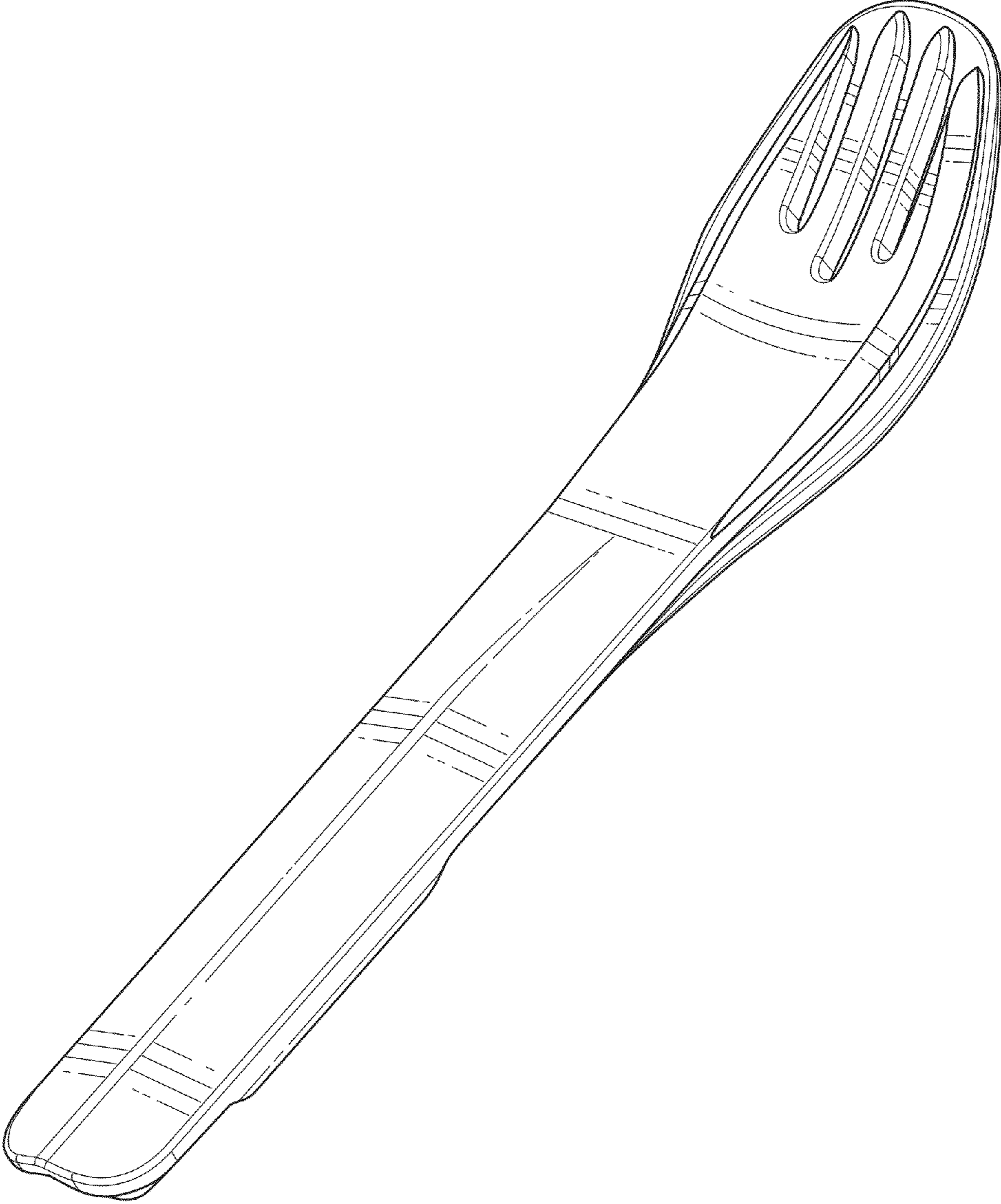

FIG. 1

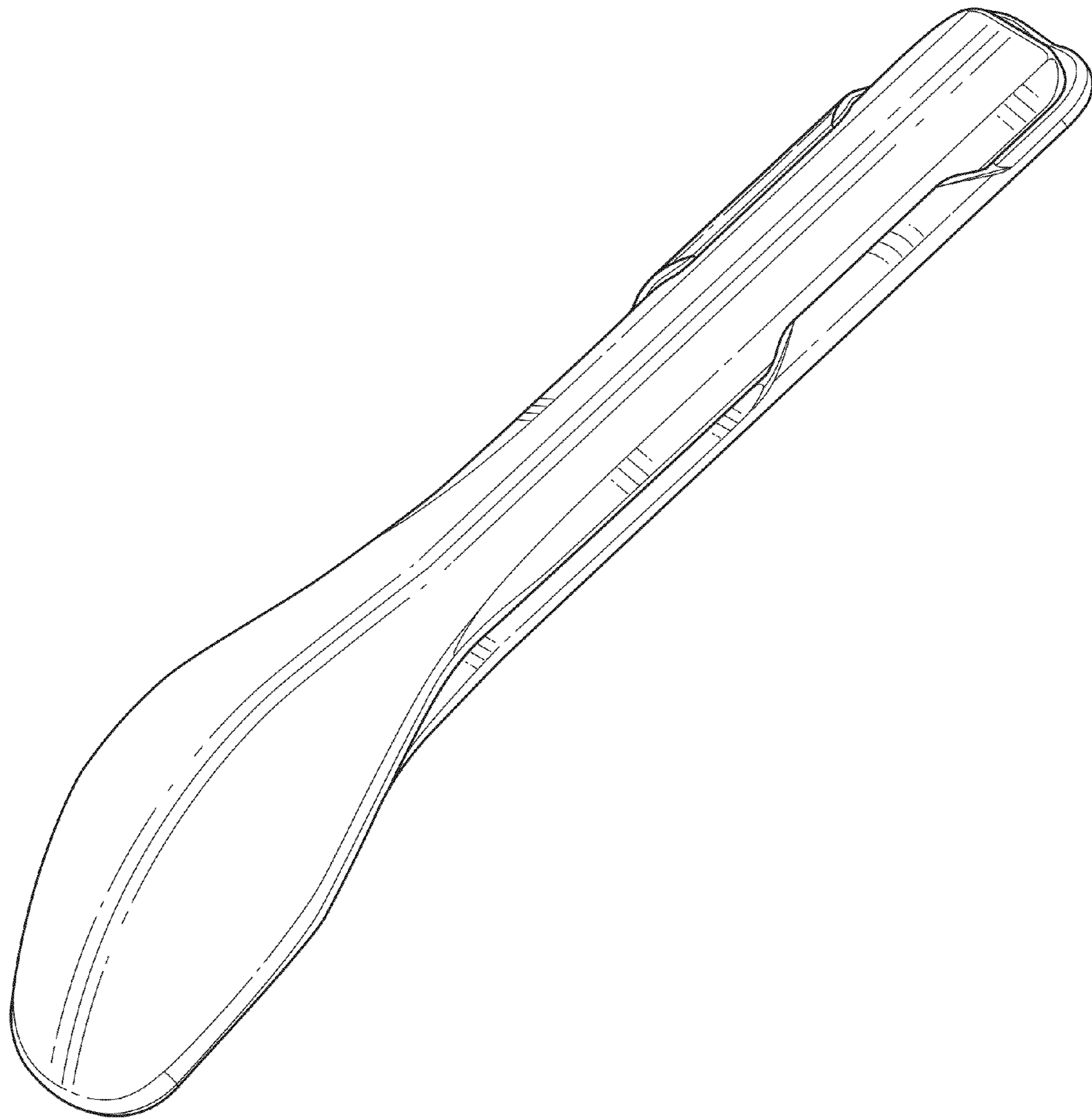

FIG. 2

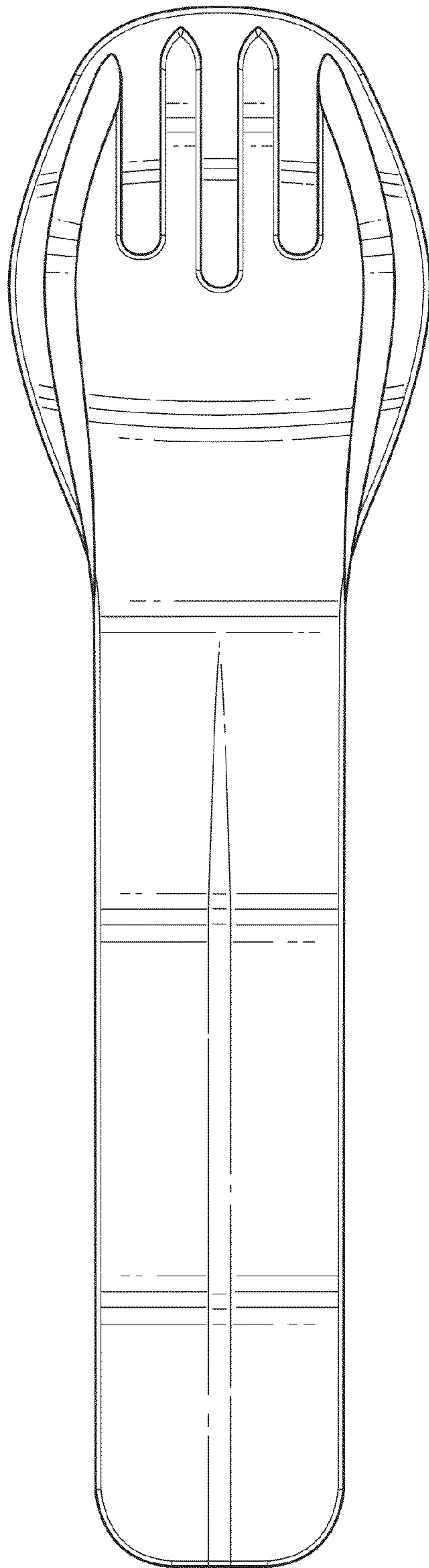

FIG. 3

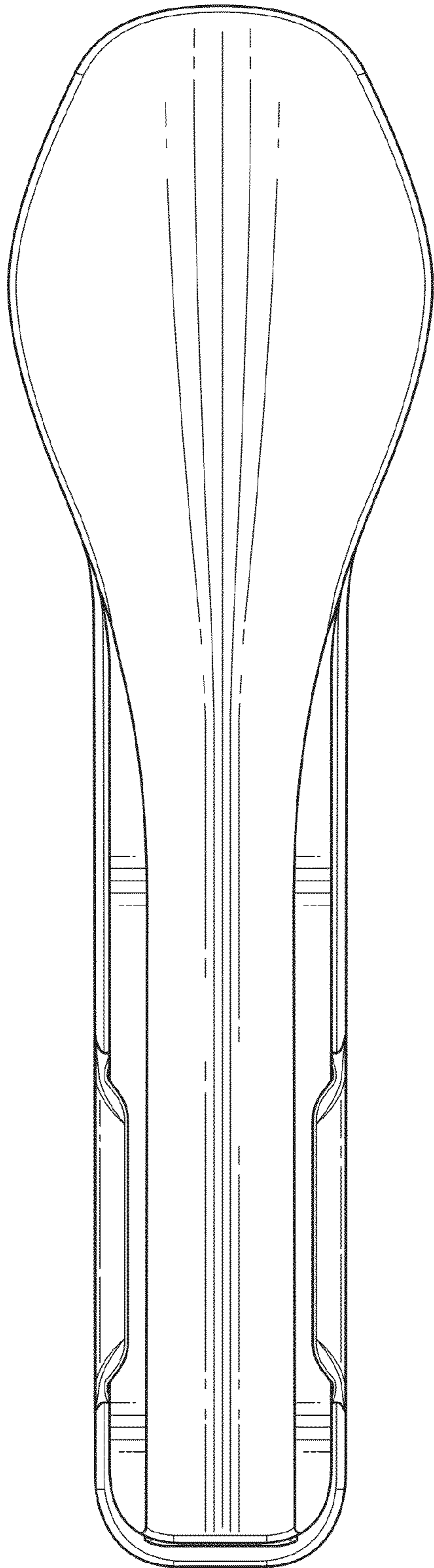

FIG. 4

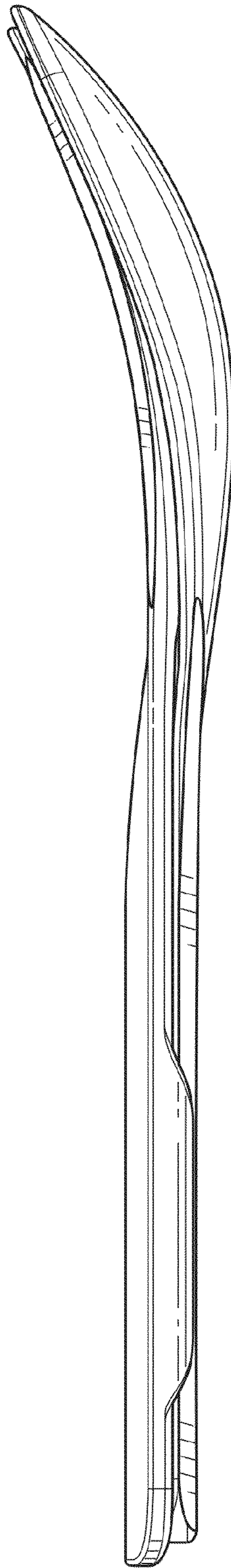

FIG. 5

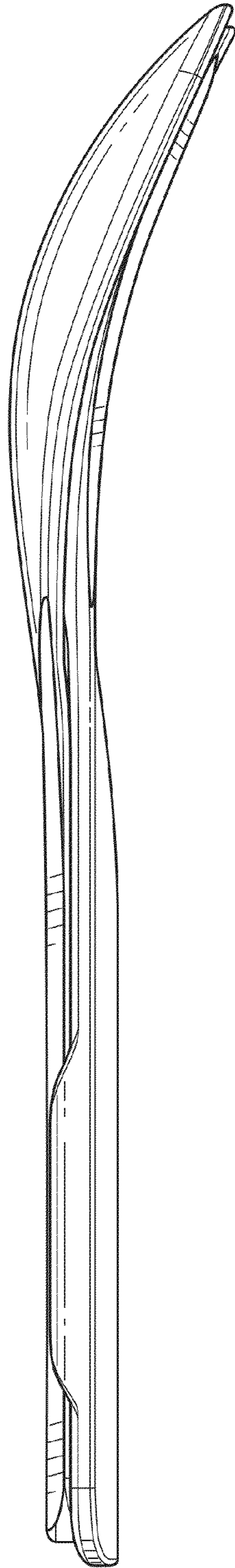

FIG. 6

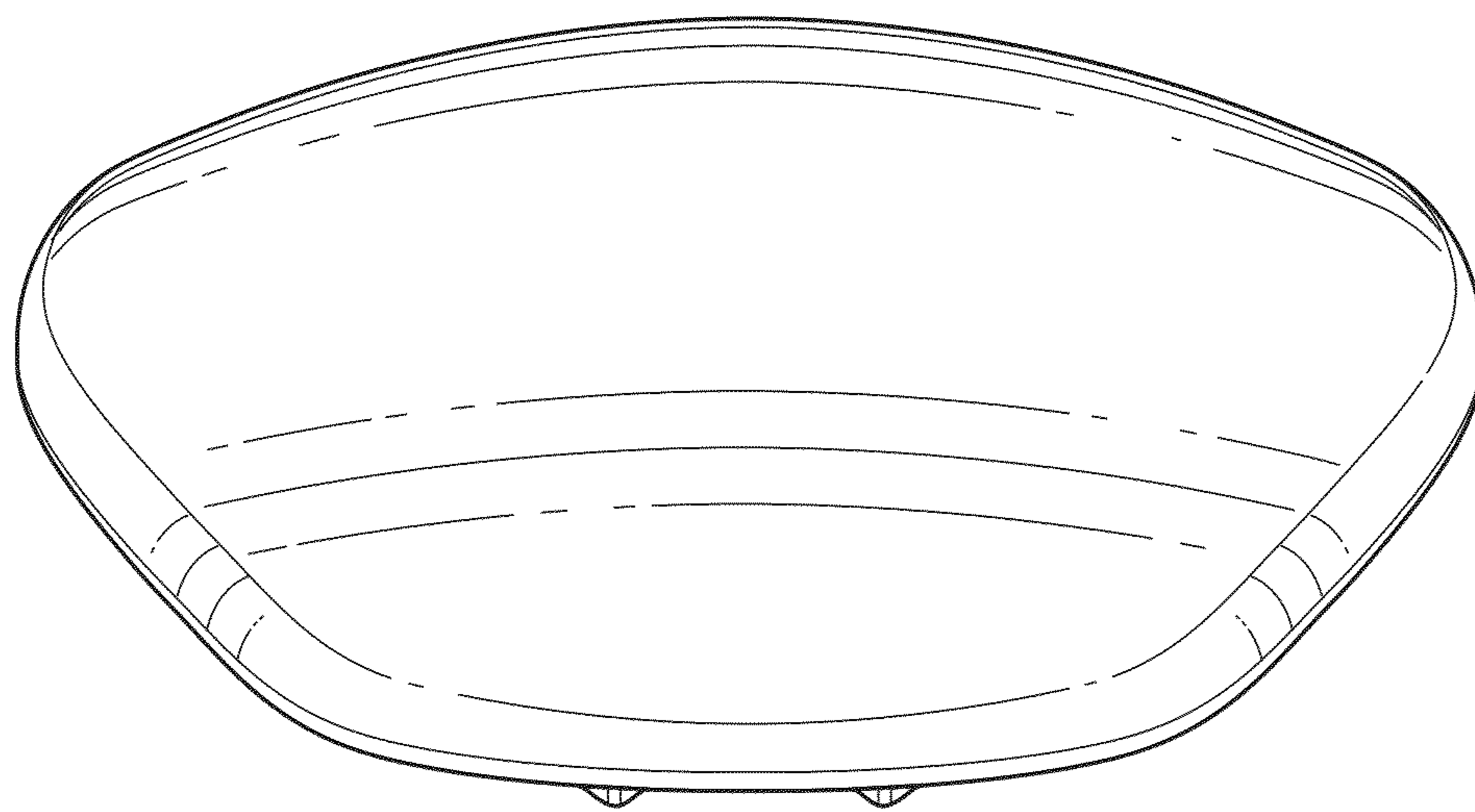

FIG. 7

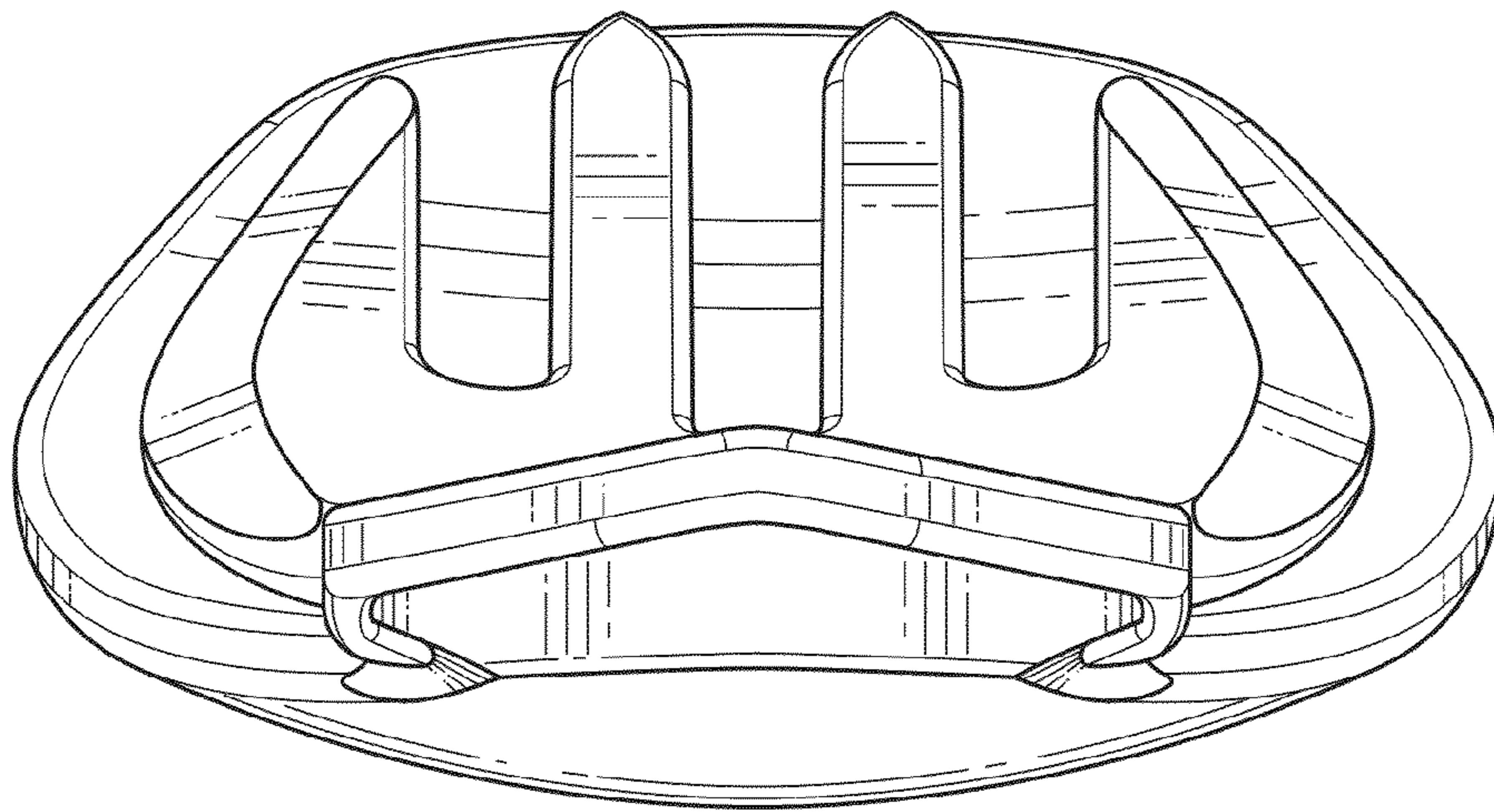

FIG. 8

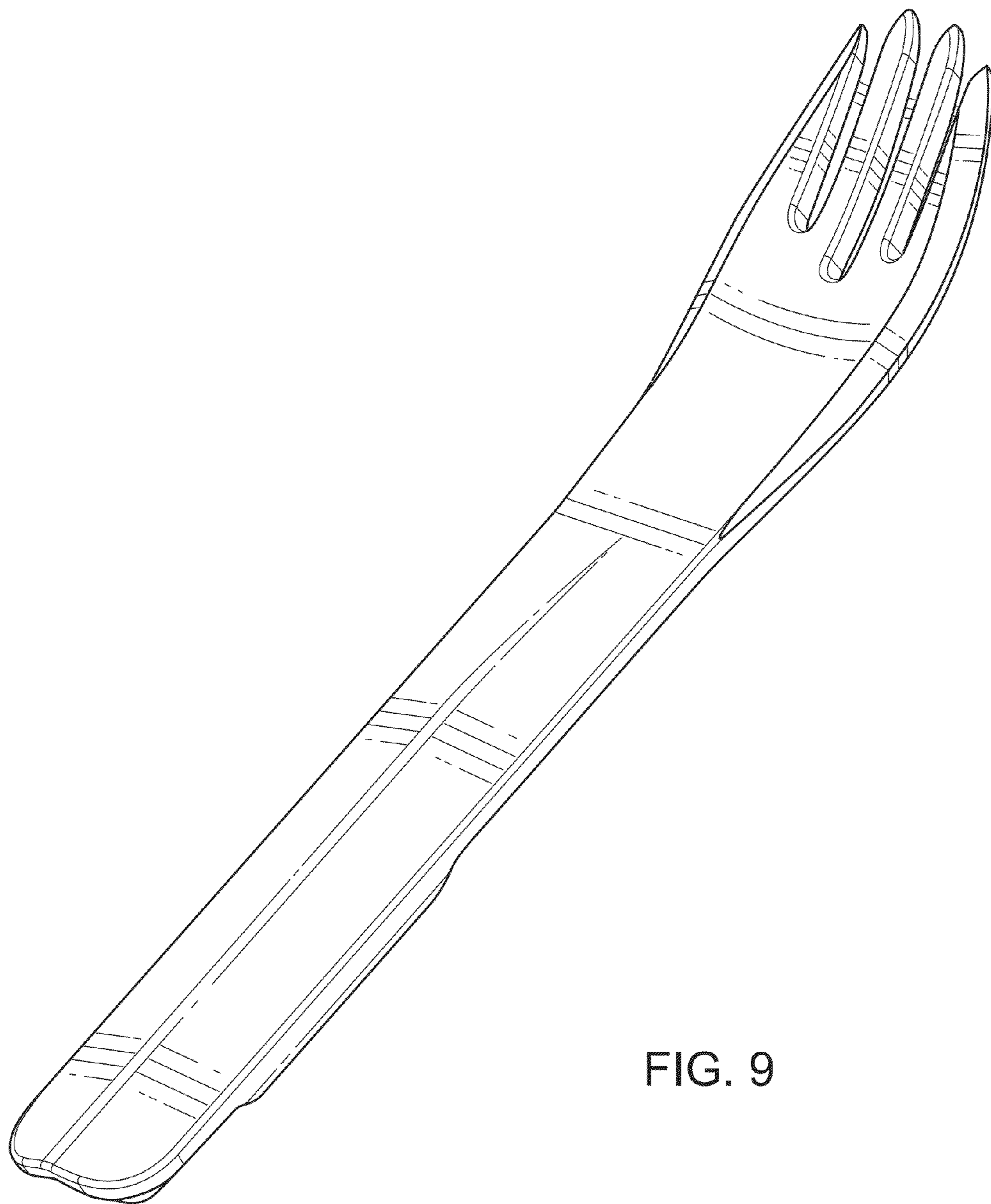

FIG. 9

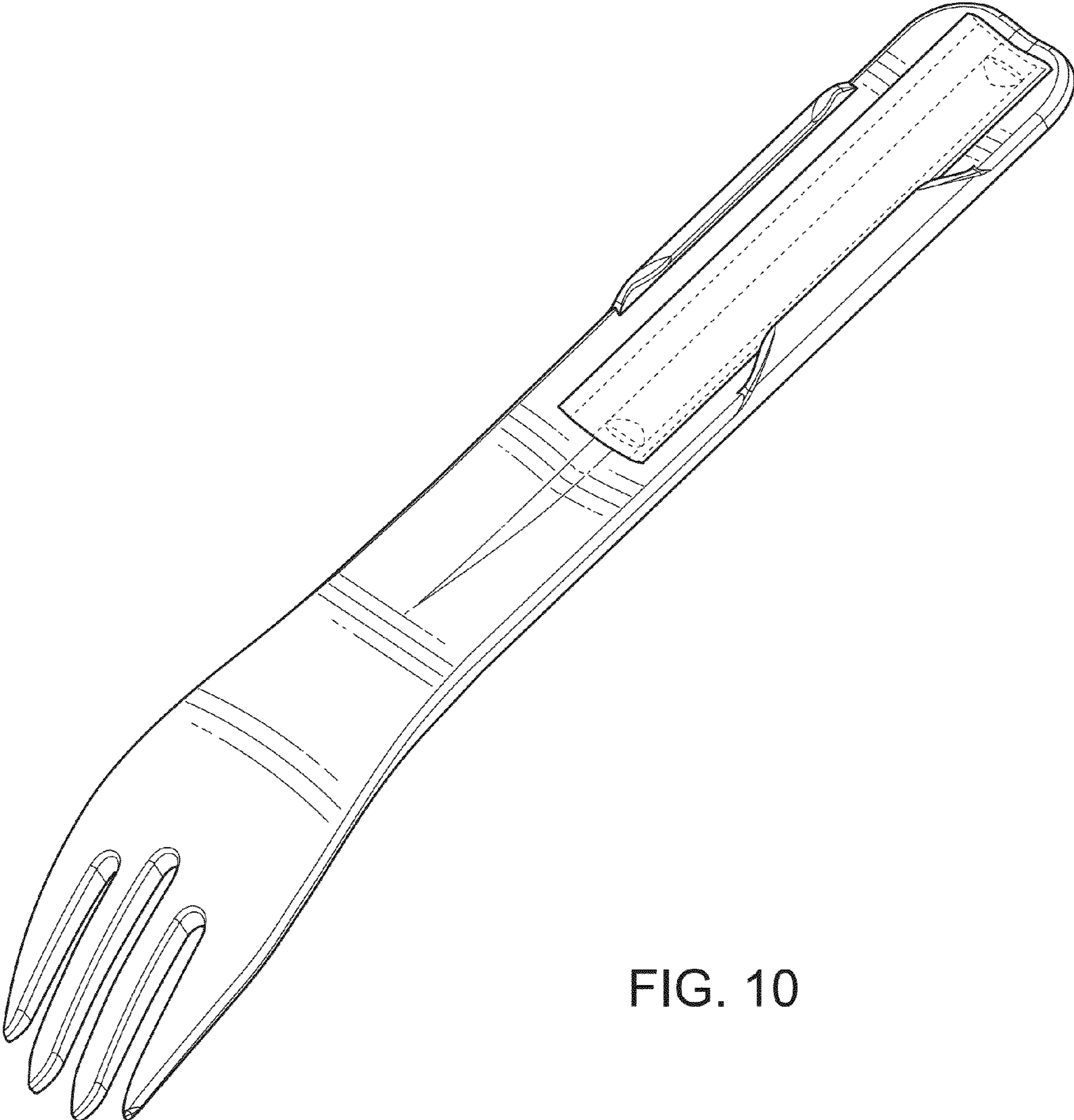

FIG. 10

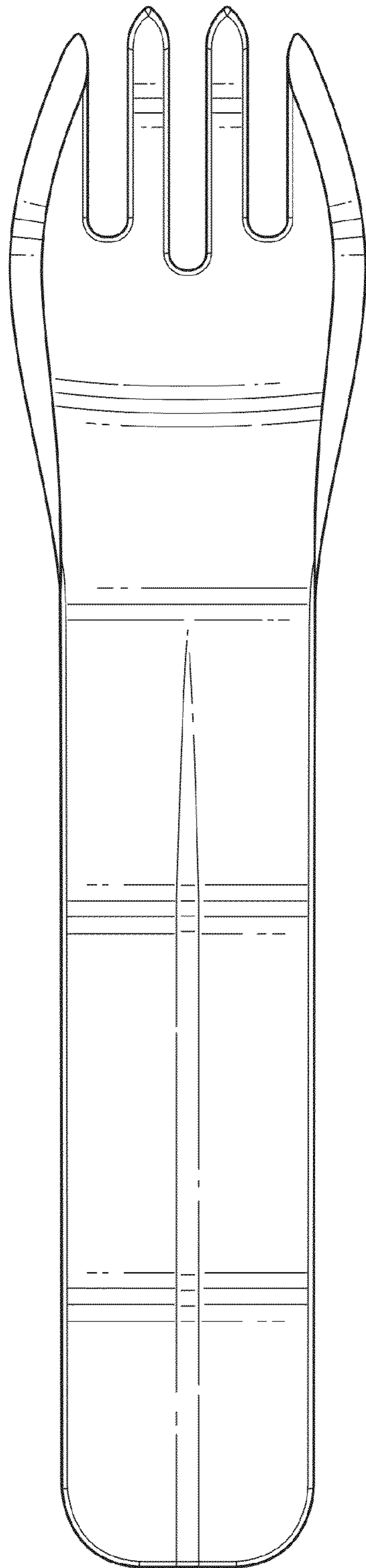

FIG. 11

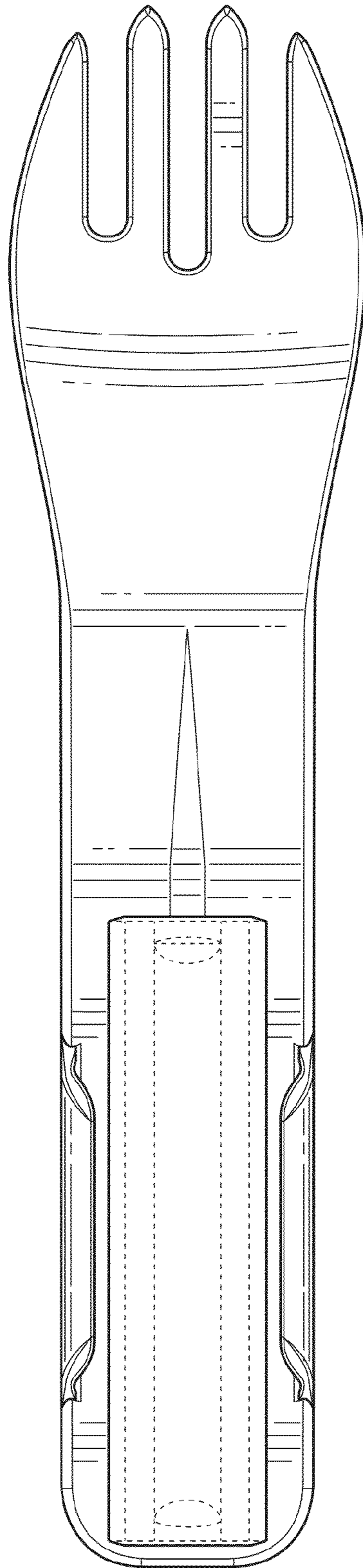

FIG. 12

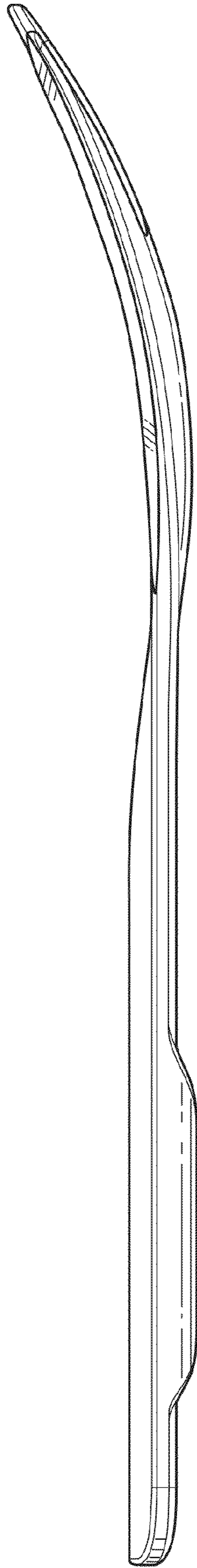

FIG. 13

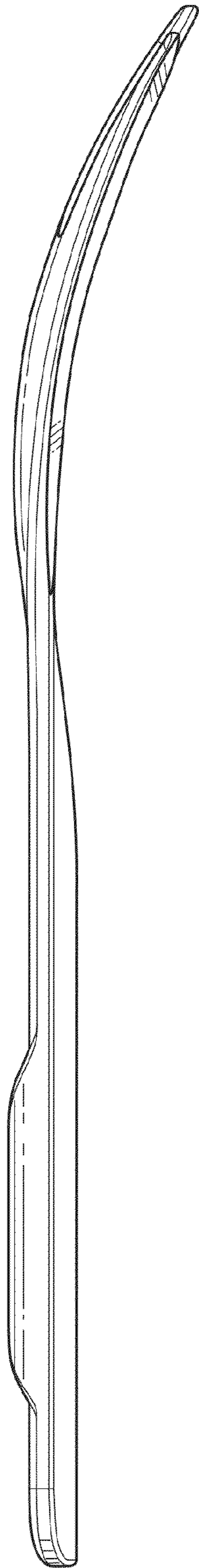

FIG. 14

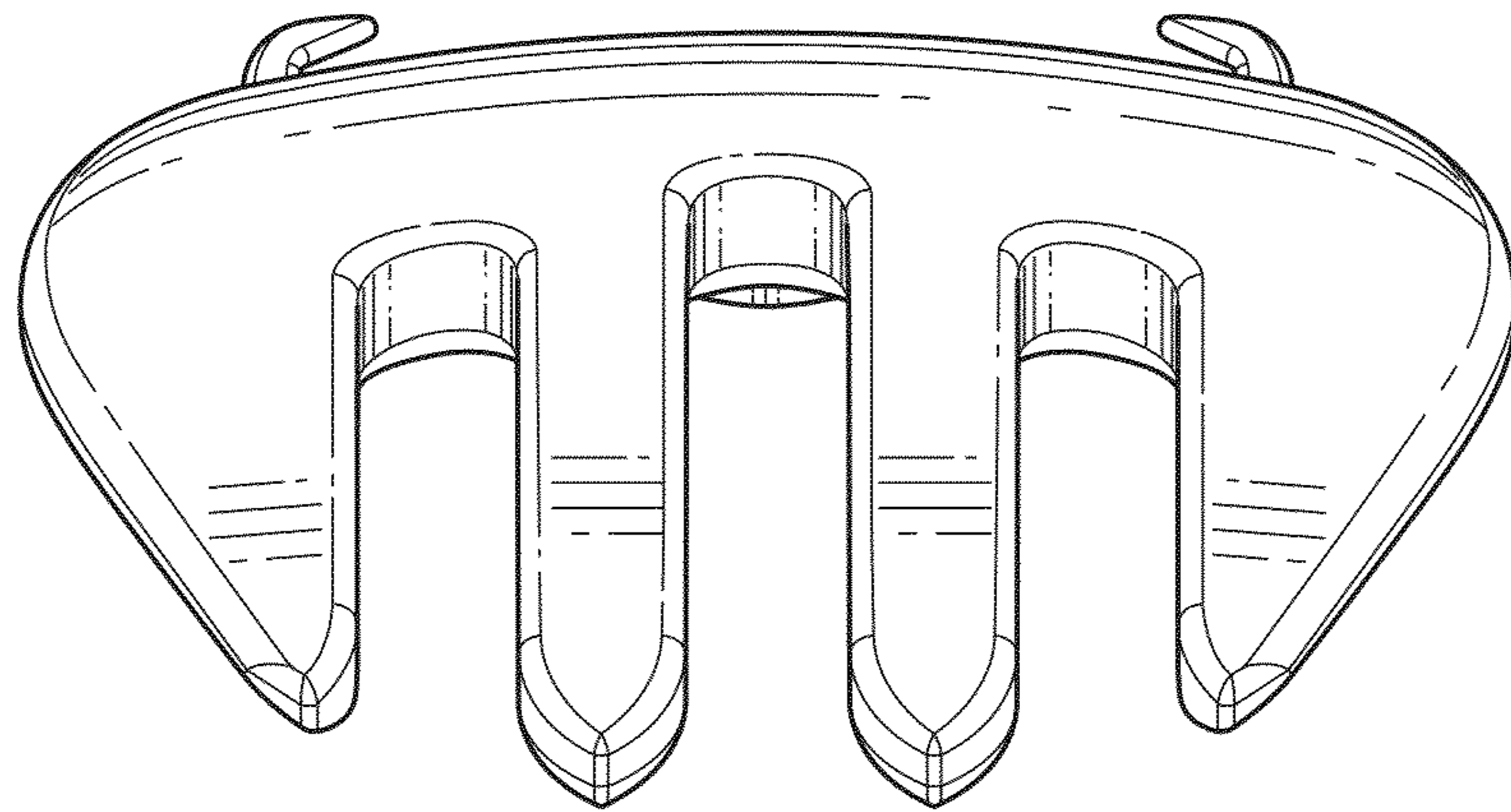

FIG. 15

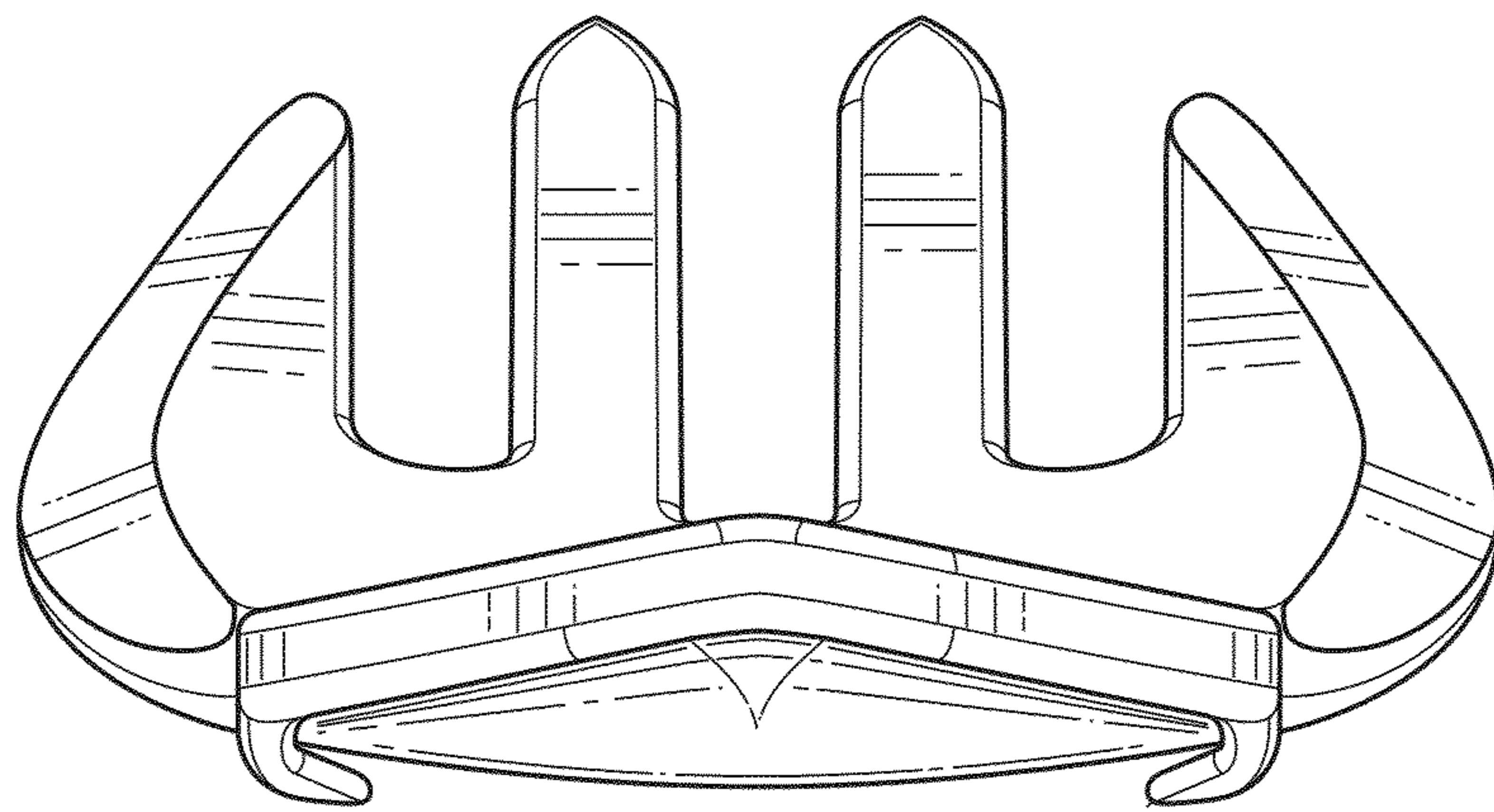

FIG. 16

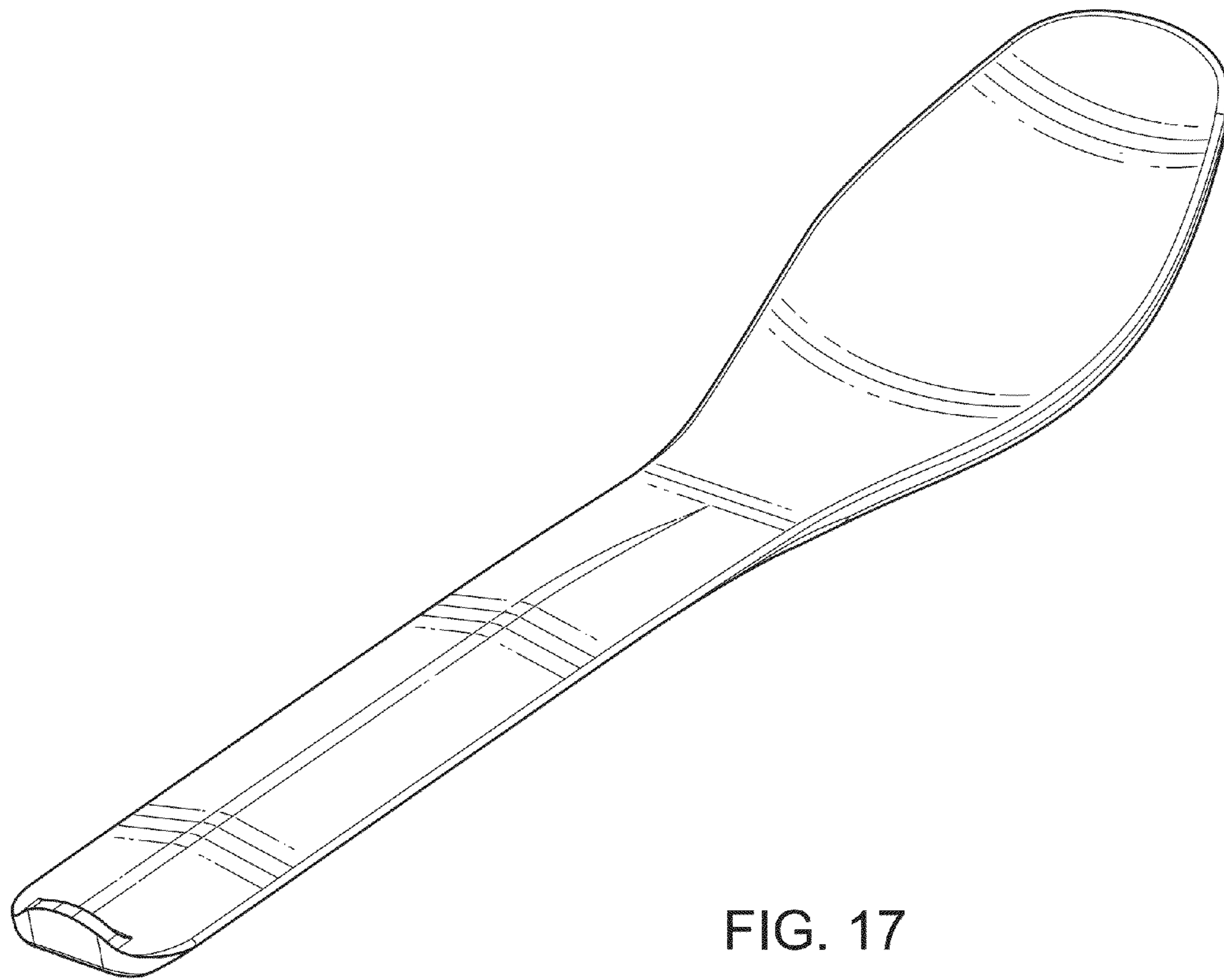

FIG. 17

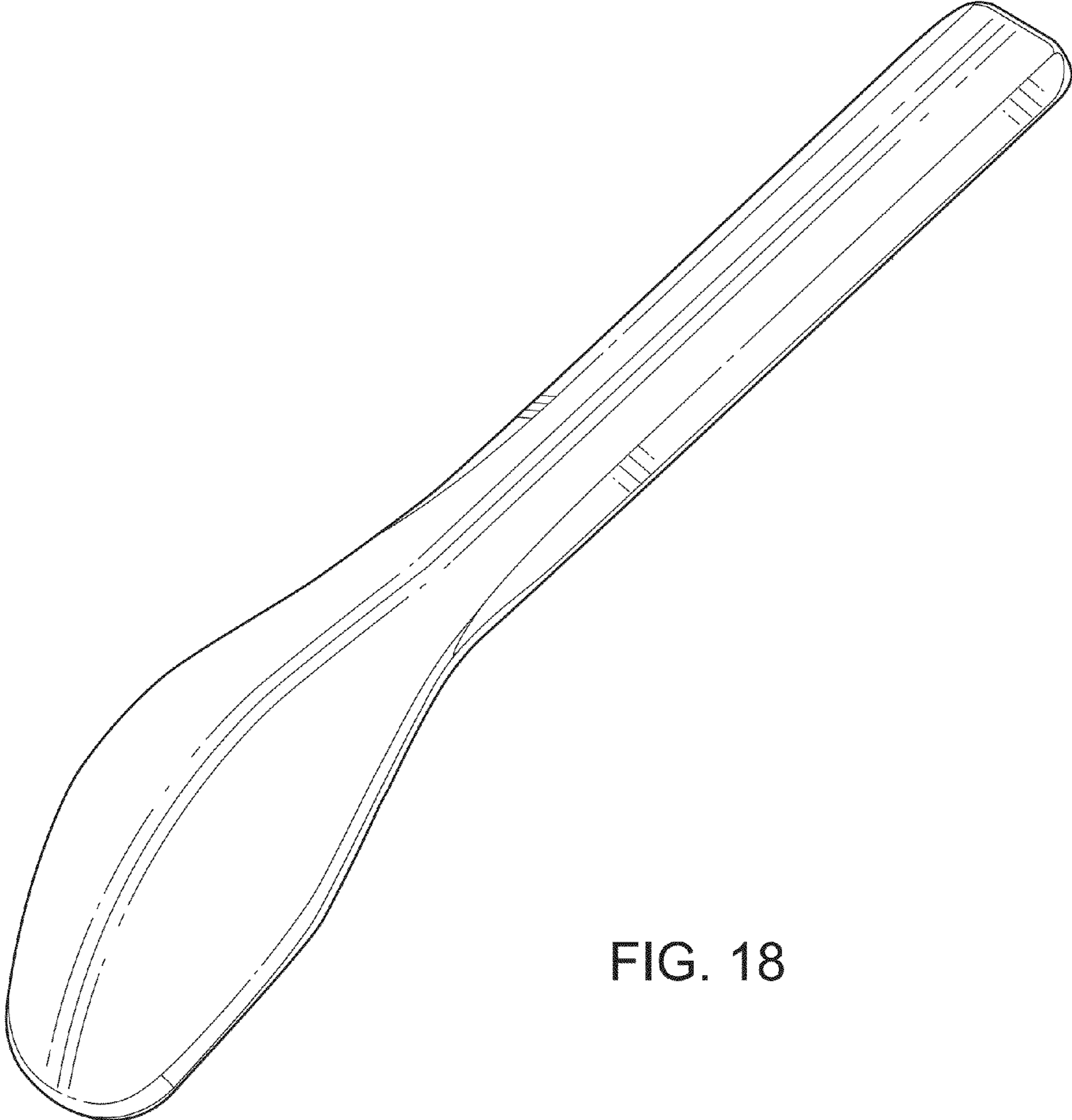

FIG. 18

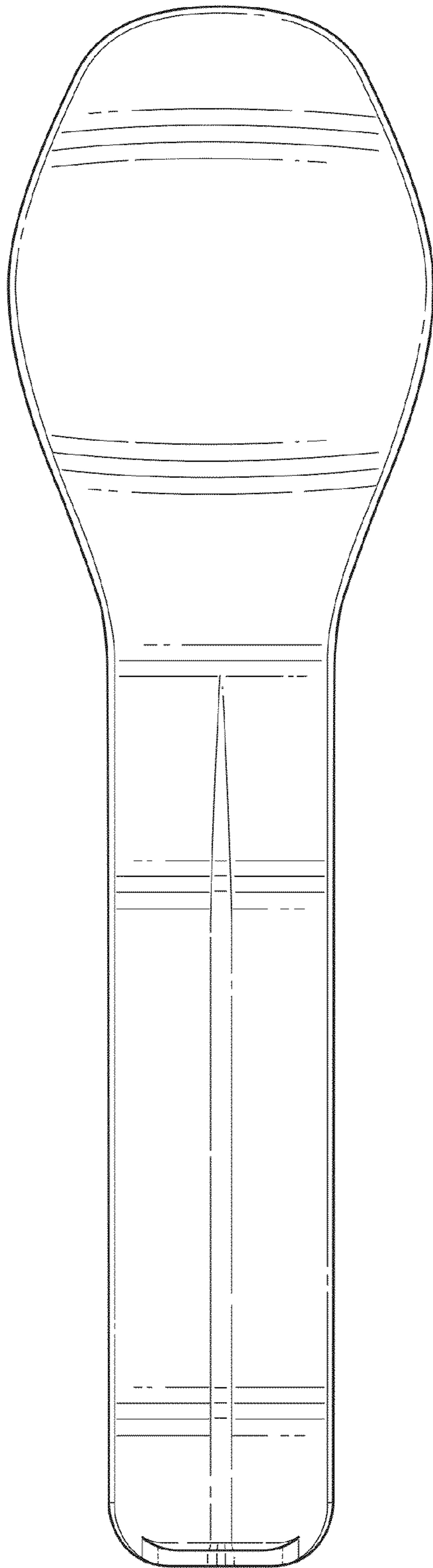

FIG. 19

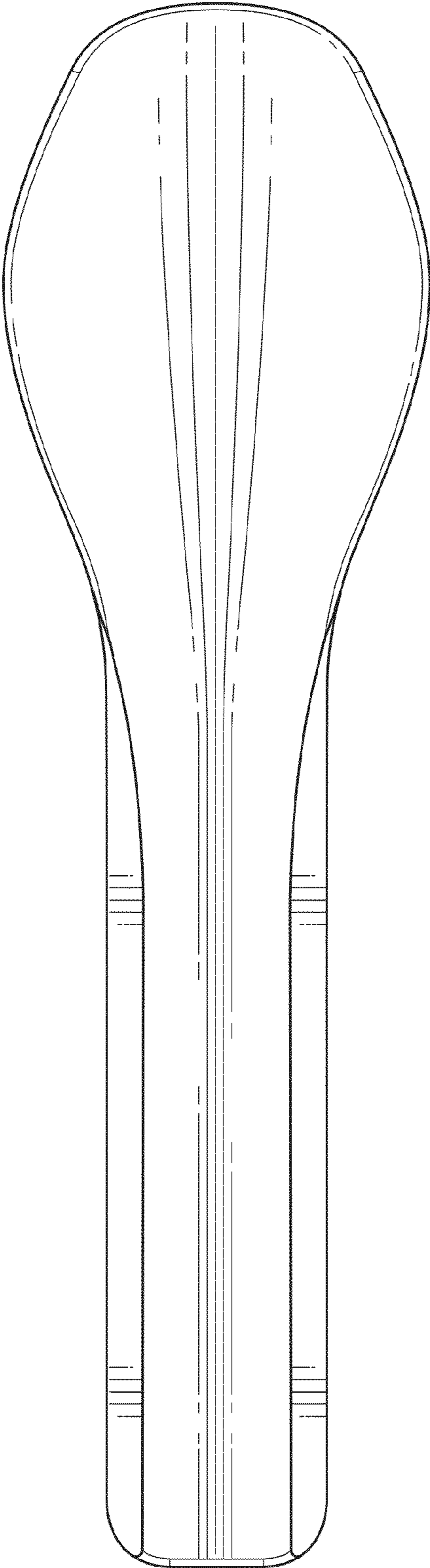

FIG. 20

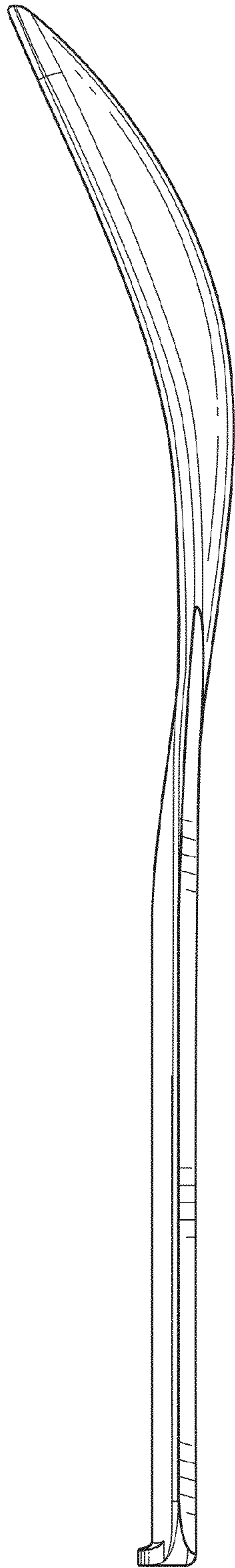

FIG. 21

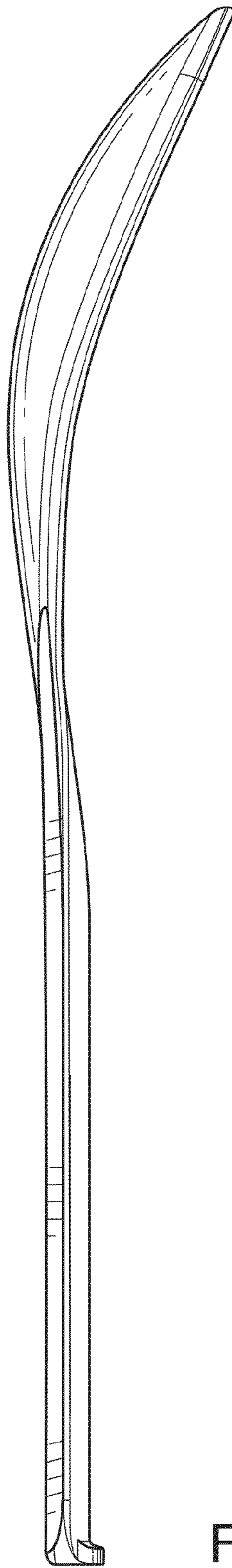

FIG. 22

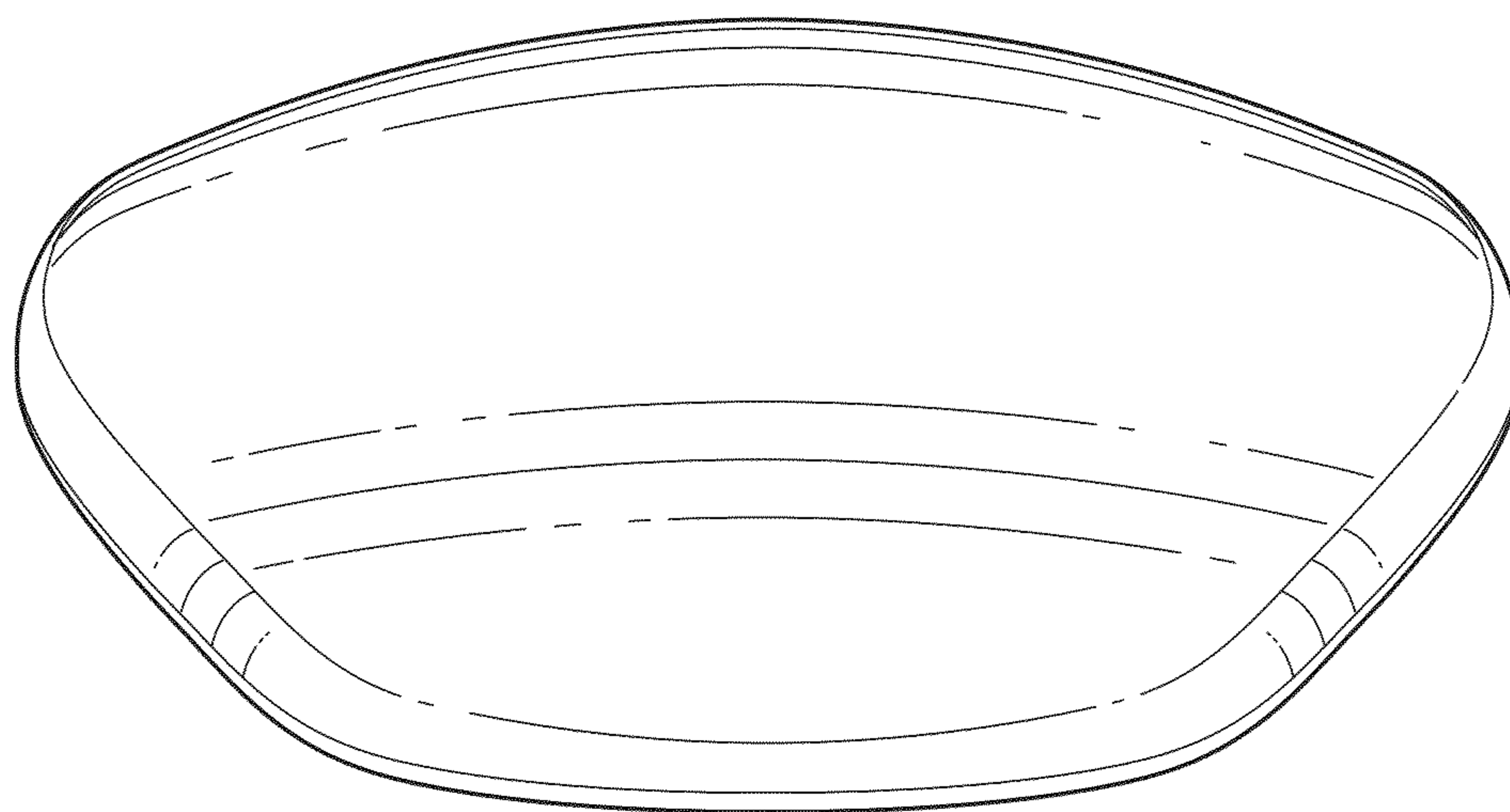

FIG. 23

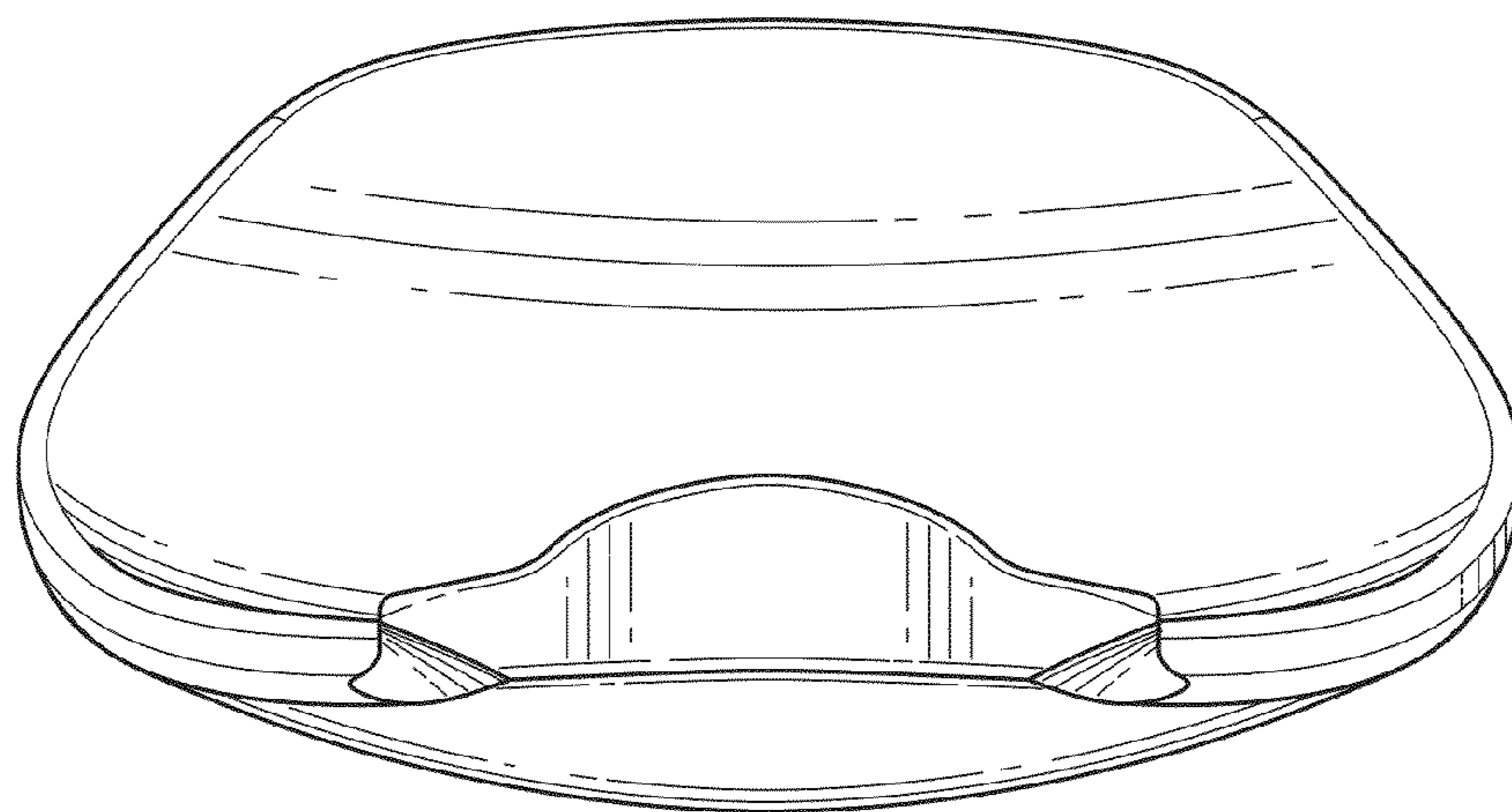

FIG. 24

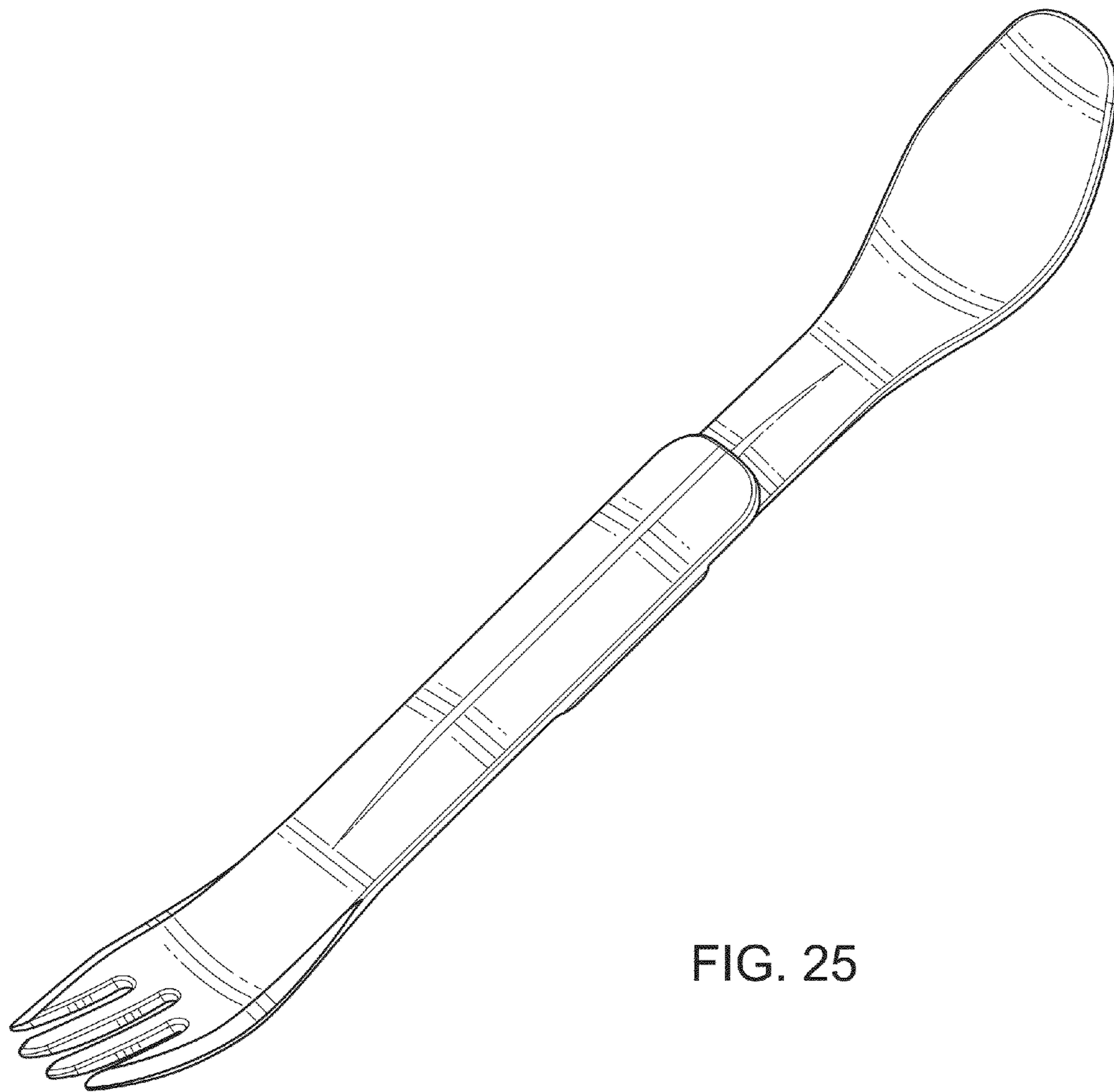

FIG. 25

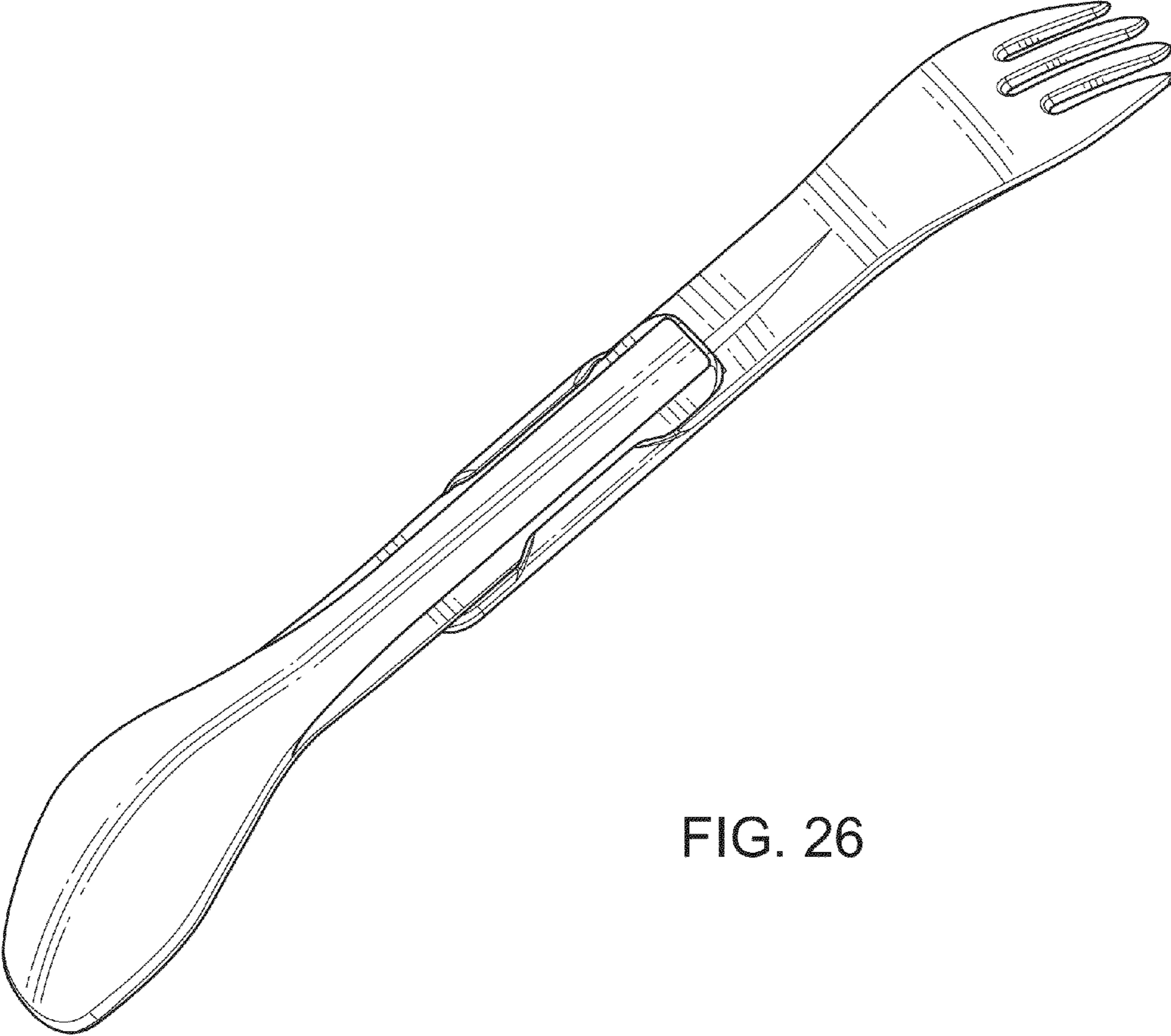

FIG. 26

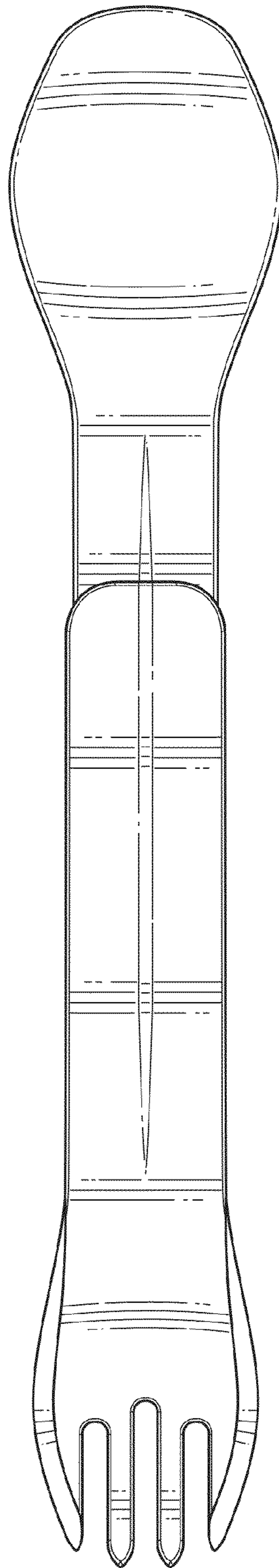

FIG. 27

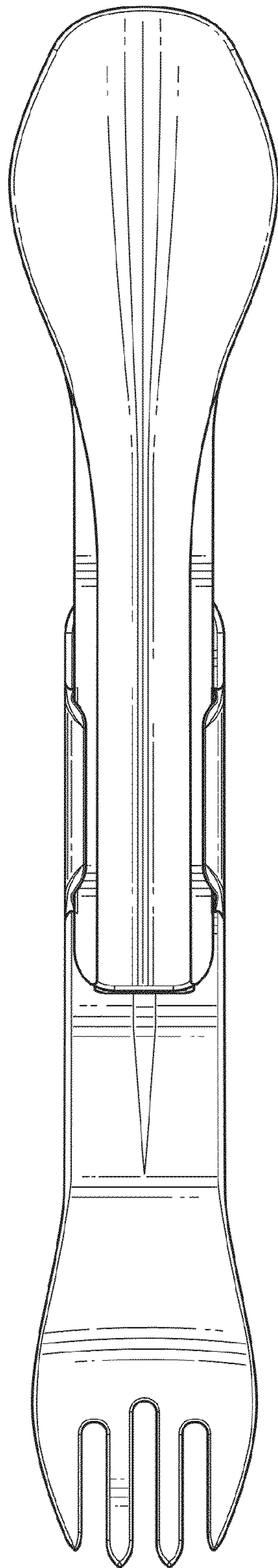

FIG. 28

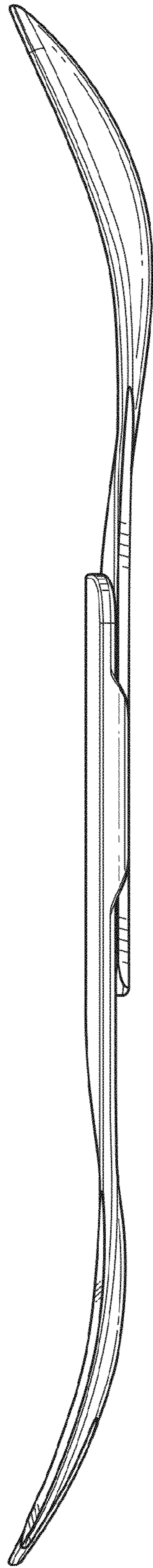

FIG. 29

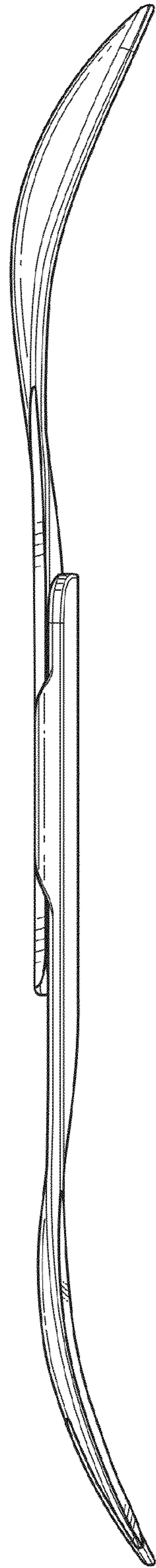

FIG. 30

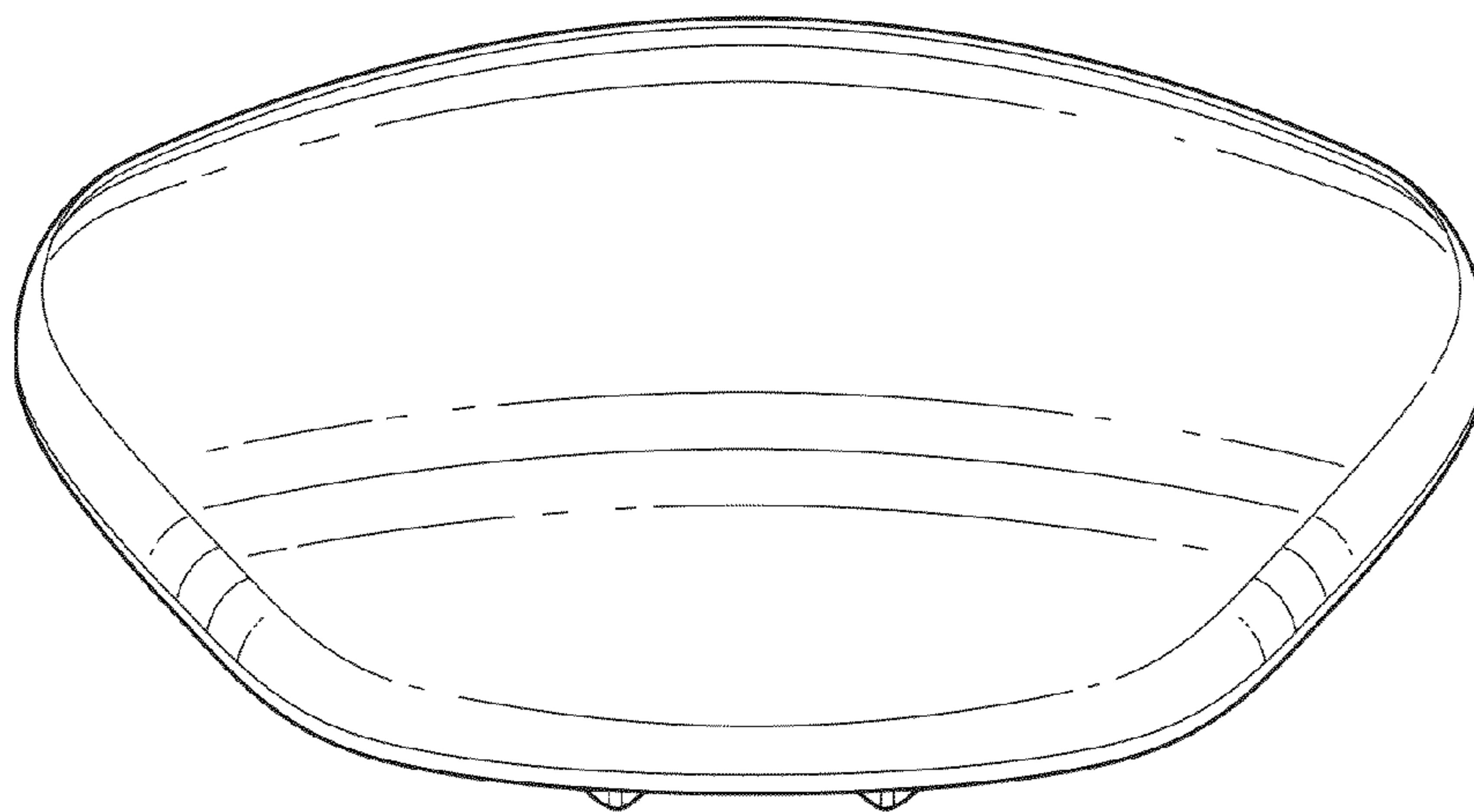

FIG. 31

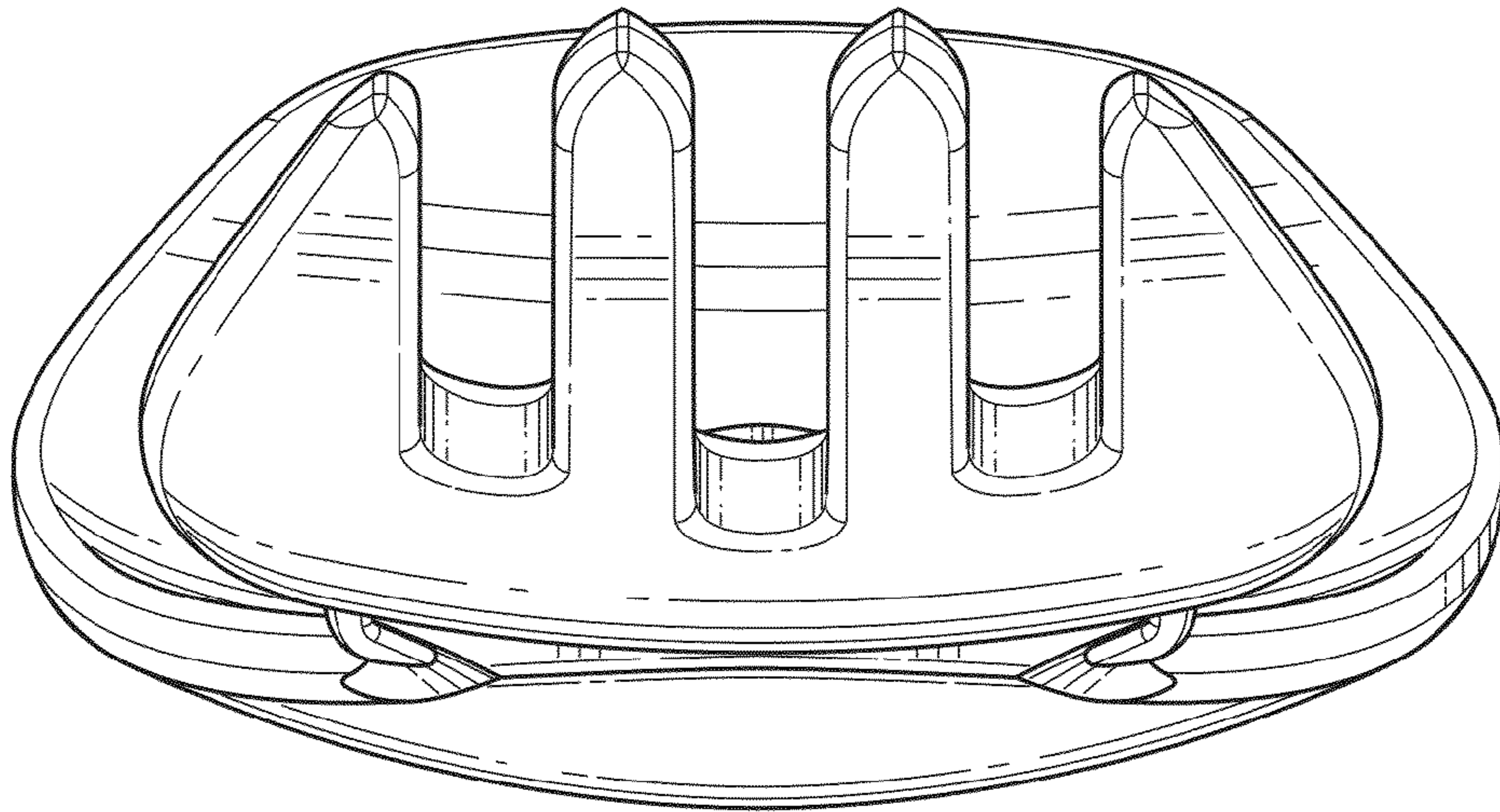

FIG. 32