



US00D722816S

(12) **United States Design Patent**
Lee et al.

(10) **Patent No.:** **US D722,816 S**
(45) **Date of Patent:** **** Feb. 24, 2015**

(54) **OVEN**

(71) Applicant: **Samsung Electronics Co., Ltd.**,
Suwon-si (KR)

(72) Inventors: **Soo-Jung Lee**, Kimpo-Si (KR);
Hong-Pyo Kim, Seoul (KR); **Chi-Young**
Ahn, Seoul (KR); **Alex Rochat**, Seoul
(KR)

(73) Assignee: **Samsung Electronics Co., Ltd.**,
Suwon-si (KR)

(**) Term: **14 Years**

(21) Appl. No.: **29/496,074**

(22) Filed: **Jul. 9, 2014**

(30) **Foreign Application Priority Data**

Jan. 15, 2014 (KR) 30-2014-0002407

(51) **LOC (10) Cl.** **07-02**

(52) **U.S. Cl.**
USPC **D7/405**

(58) **Field of Classification Search**
USPC D7/339-441, 346-349, 350.1-350.4,
D7/402, 405-406; 126/19 R, 21 A, 21 R,
126/39 B, 39 C, 239 R, 273 A, 273 R;
219/391-394, 756-758; 99/DIG. 14
See application file for complete search history.

(56) **References Cited**

U.S. PATENT DOCUMENTS

D429,954 S *	8/2000	Orzel et al.	D7/405
D462,867 S *	9/2002	Resuello et al.	D7/349
D468,962 S *	1/2003	Jones et al.	D7/405
D521,317 S *	5/2006	Hessen et al.	D7/405
D521,805 S *	5/2006	Hessen et al.	D7/405
D525,476 S *	7/2006	Bengtson et al.	D7/349
D527,948 S *	9/2006	Bengtson	D7/405

D546,121 S *	7/2007	Hessen et al.	D7/405
D560,958 S *	2/2008	Shin et al.	D7/348
D572,527 S *	7/2008	Crookshanks	D7/405
D572,528 S *	7/2008	Crookshanks	D7/405
D572,530 S *	7/2008	Crookshanks et al.	D7/405
D618,488 S *	6/2010	Knochner	D7/350.1
D626,782 S *	11/2010	Busalt et al.	D7/349
D628,438 S *	12/2010	Knochner	D7/405
D633,336 S *	3/2011	Sadtler	D7/405
D644,487 S *	9/2011	Crookshanks et al.	D7/405
D645,293 S *	9/2011	Busalt et al.	D7/349
D654,313 S *	2/2012	Benold	D7/402
D654,314 S *	2/2012	Benold	D7/405
D654,315 S *	2/2012	Benold	D7/405

(Continued)

Primary Examiner — T. Chase Nelson

Assistant Examiner — Mark Cavanna

(74) *Attorney, Agent, or Firm* — NSIP Law

(57) **CLAIM**

We claim the ornamental design for an oven, as shown and described.

DESCRIPTION

FIG. 1 is a front perspective view of an oven showing our new design;

FIG. 2 is a front view thereof;

FIG. 3 is a rear view thereof;

FIG. 4 is a left-side view thereof;

FIG. 5 is a right-side view thereof;

FIG. 6 is a top view thereof;

FIG. 7 is a bottom view thereof;

FIG. 8 is another front perspective view, in which the oven is provided in an alternate position; and,

FIG. 9 is an enlarged view of the encircled portion in FIG. 1.

The broken lines in the figures show portions of the oven which form no part of the claimed design.

The dot-dash broken lines encircling portions of the claimed design that are illustrated in enlargements form no part of the claimed design.

1 Claim, 9 Drawing Sheets

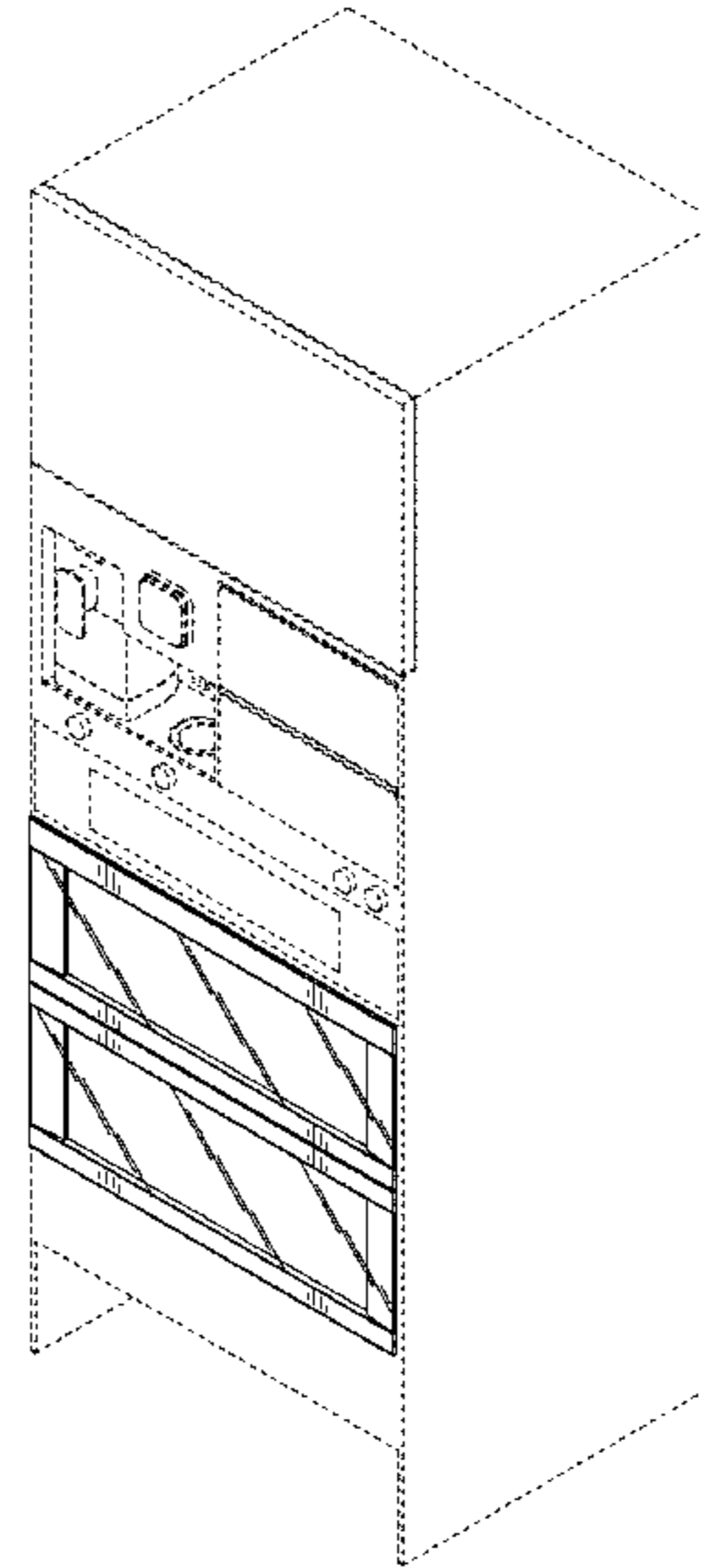
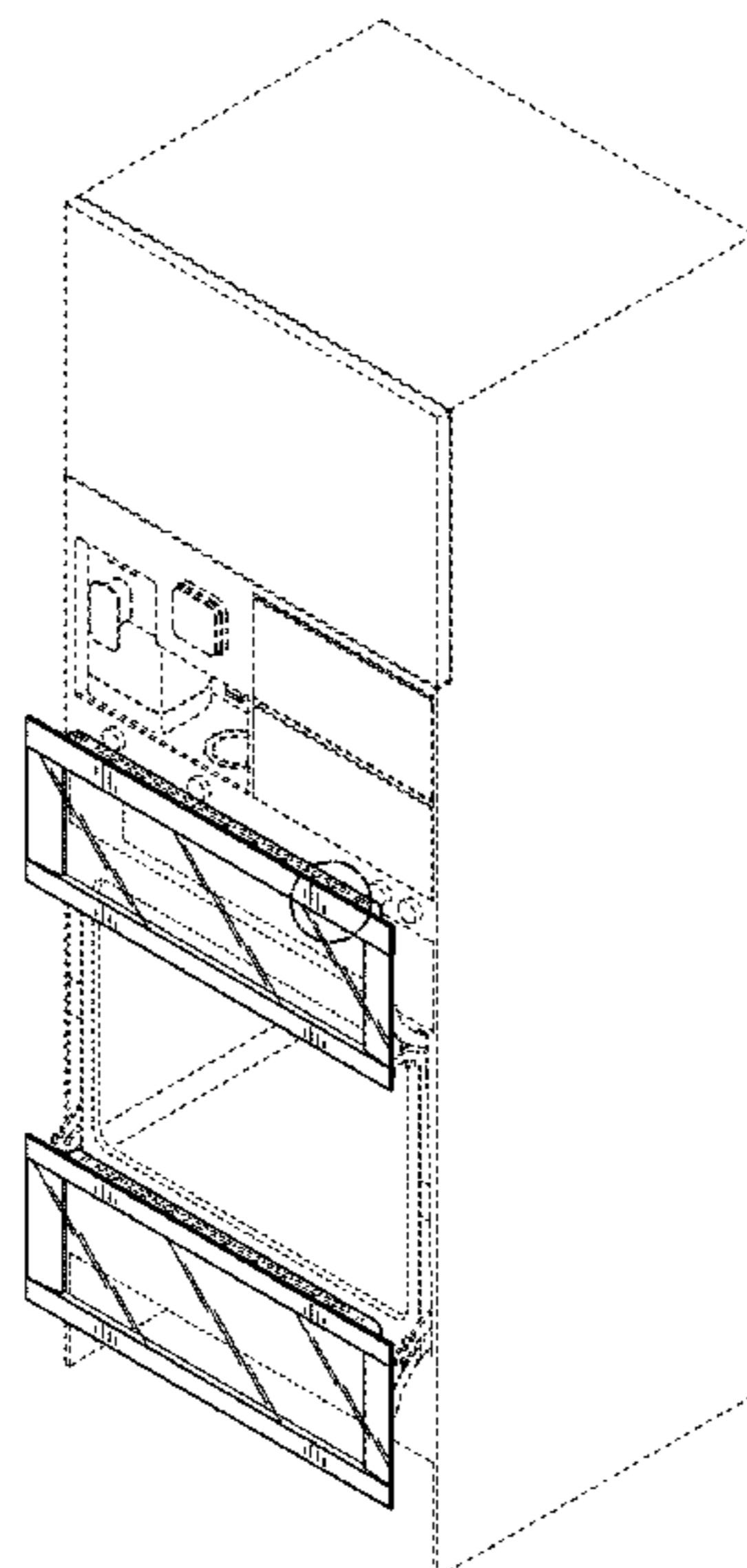

US D722,816 S

Page 2

(56)

References Cited

U.S. PATENT DOCUMENTS

D657,622 S *	4/2012	Benold	D7/405	
D662,358 S *	6/2012	Benold	D7/405	* cited by examiner
D663,584 S *	7/2012	Sadtler	D7/405	
D668,106 S *	10/2012	Borjesson	D7/405	
D696,069 S *	12/2013	Roberson et al.	D7/405	

FIG. 1

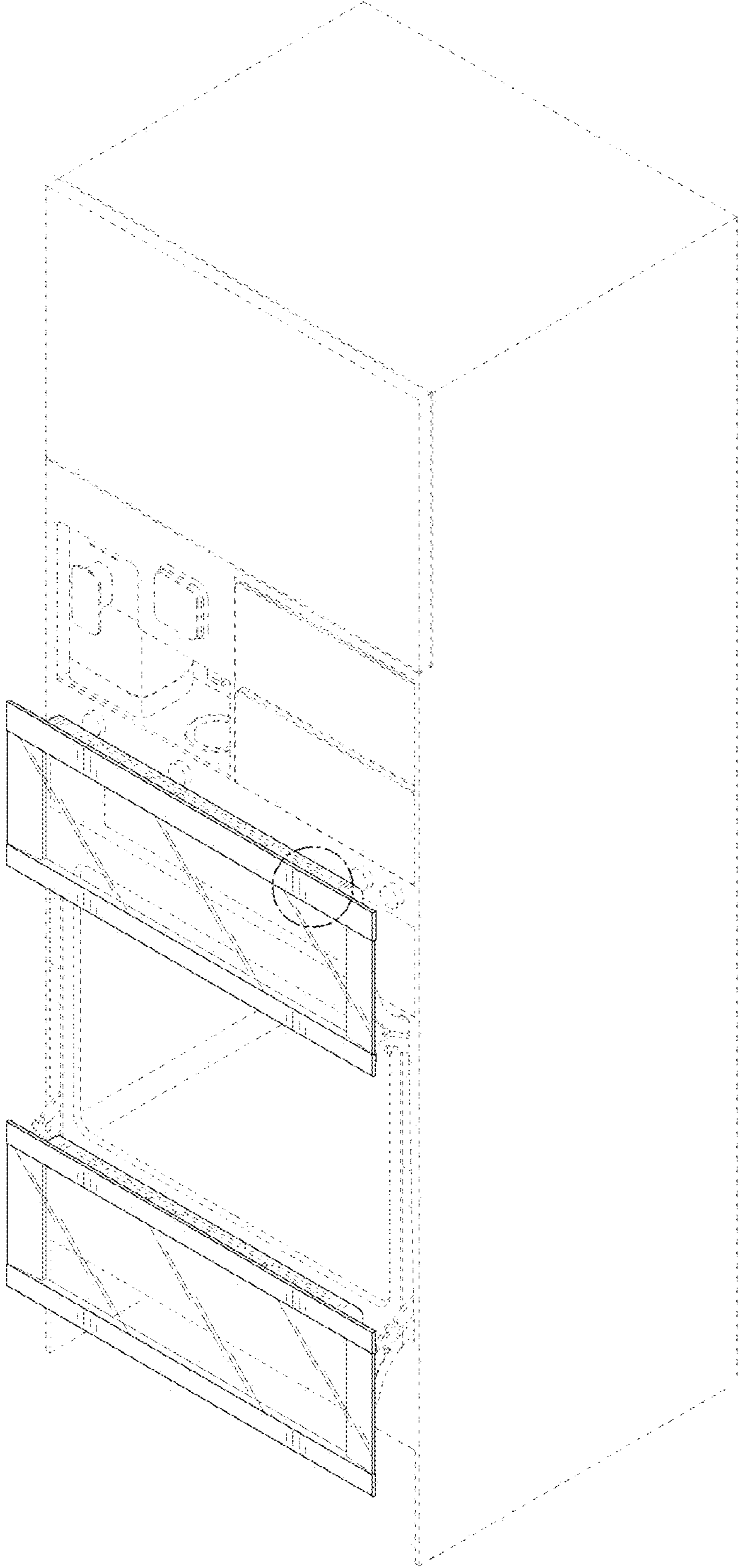

FIG. 2

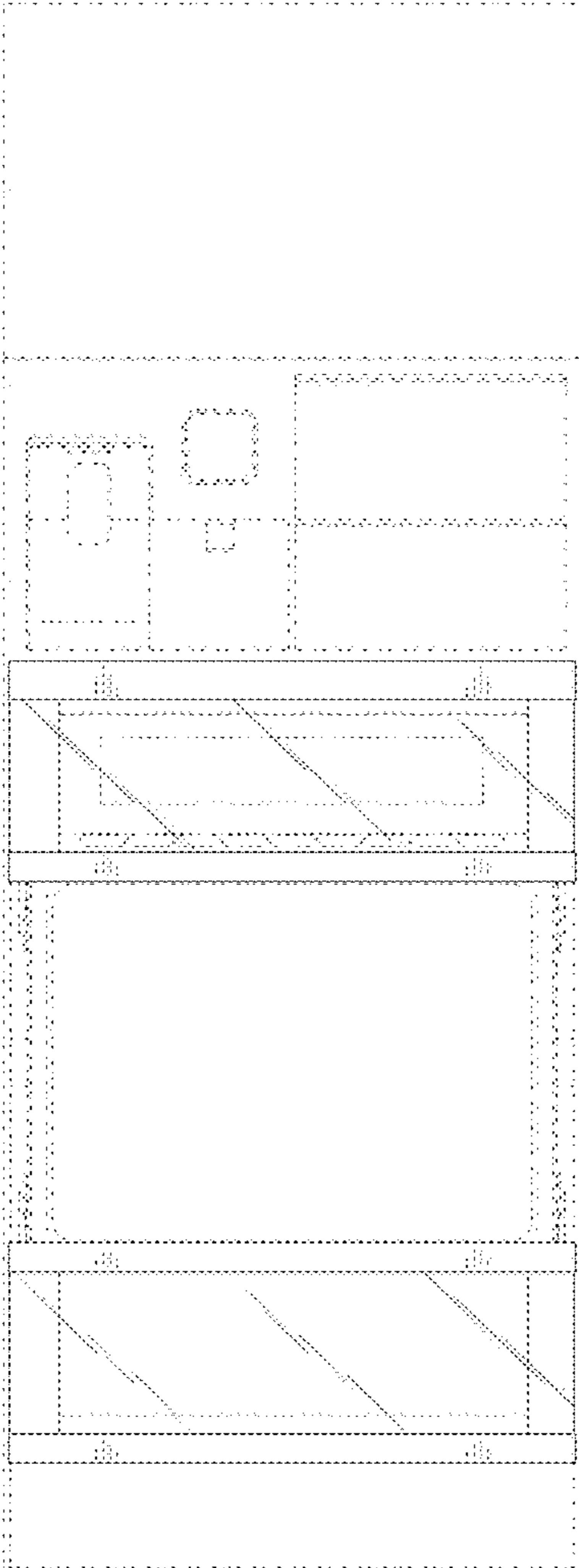

FIG. 3

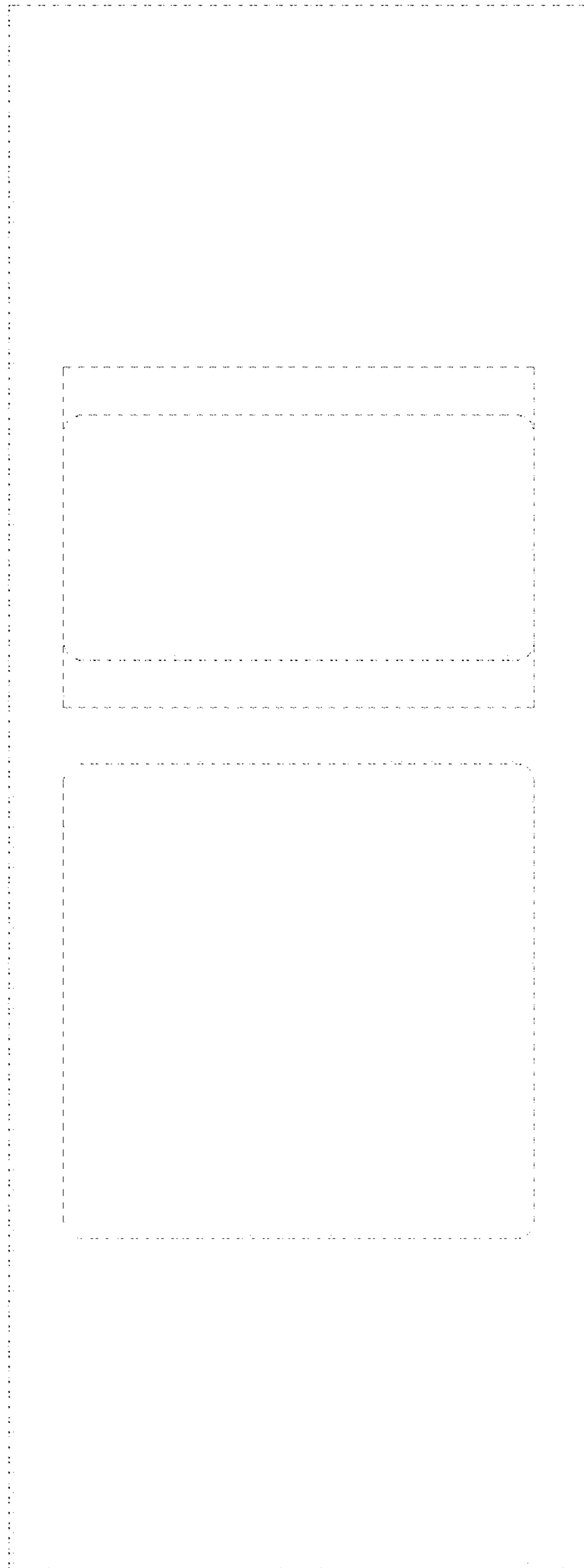

FIG. 4

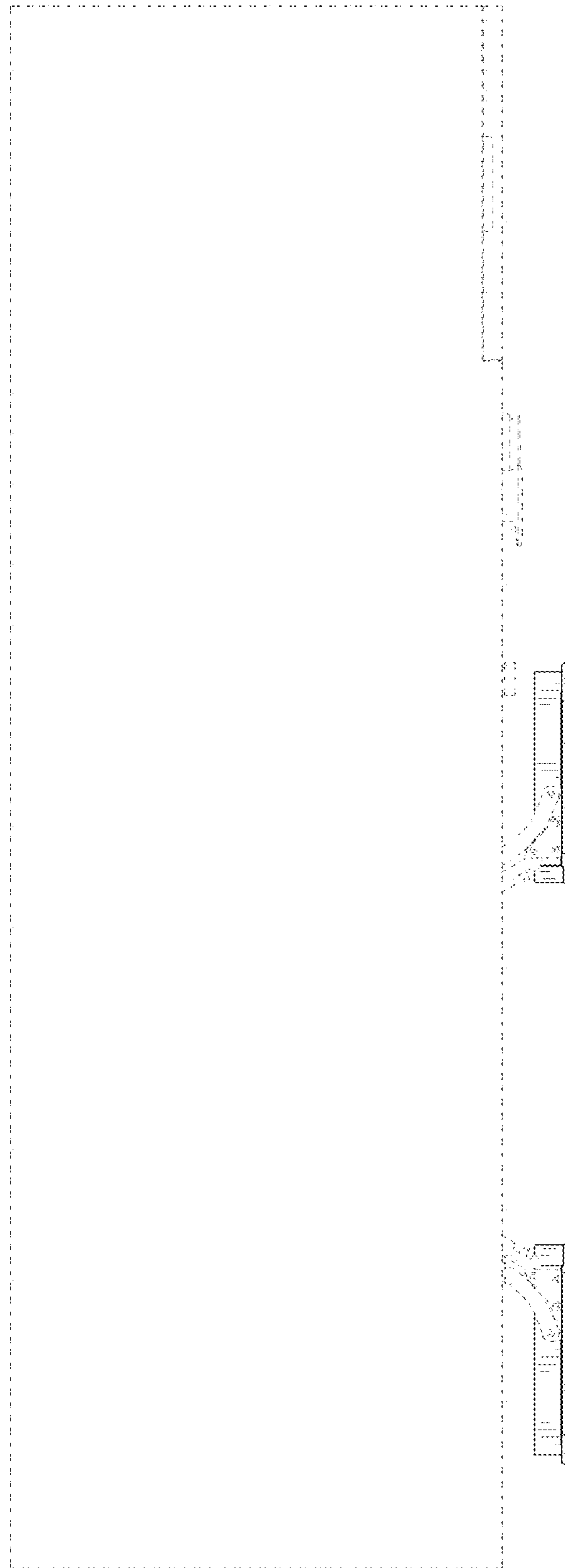

FIG. 5

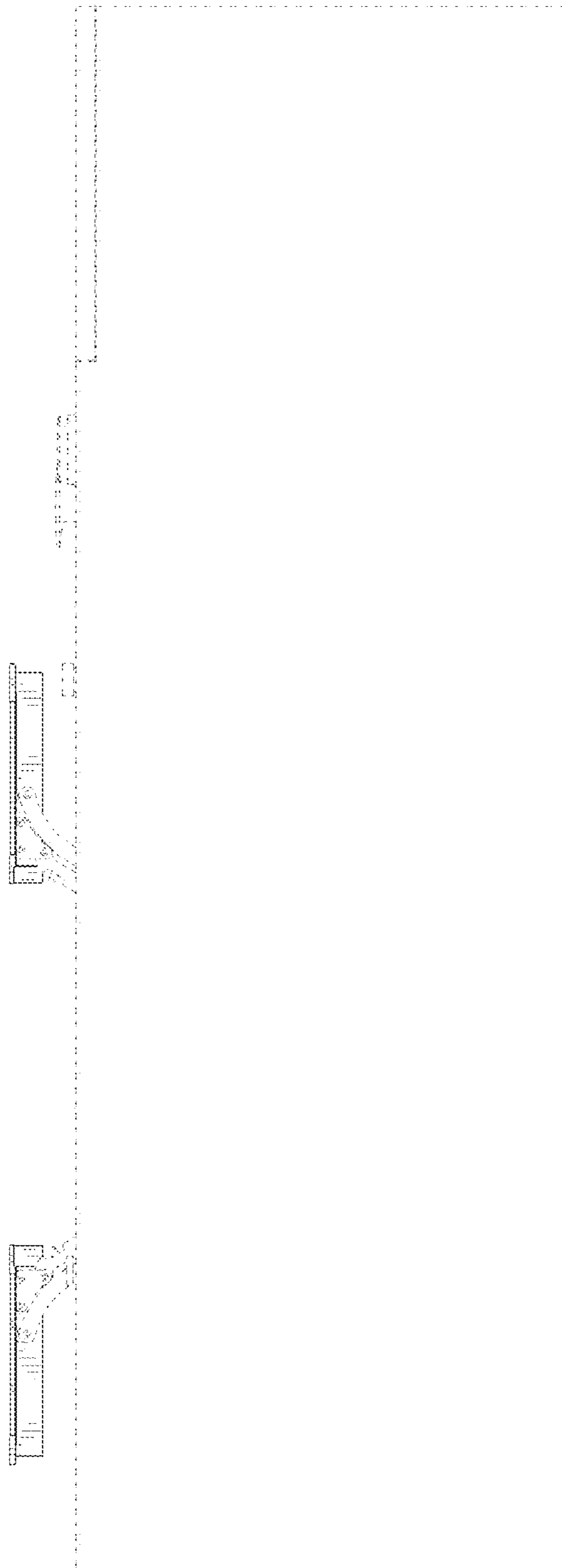

FIG. 6

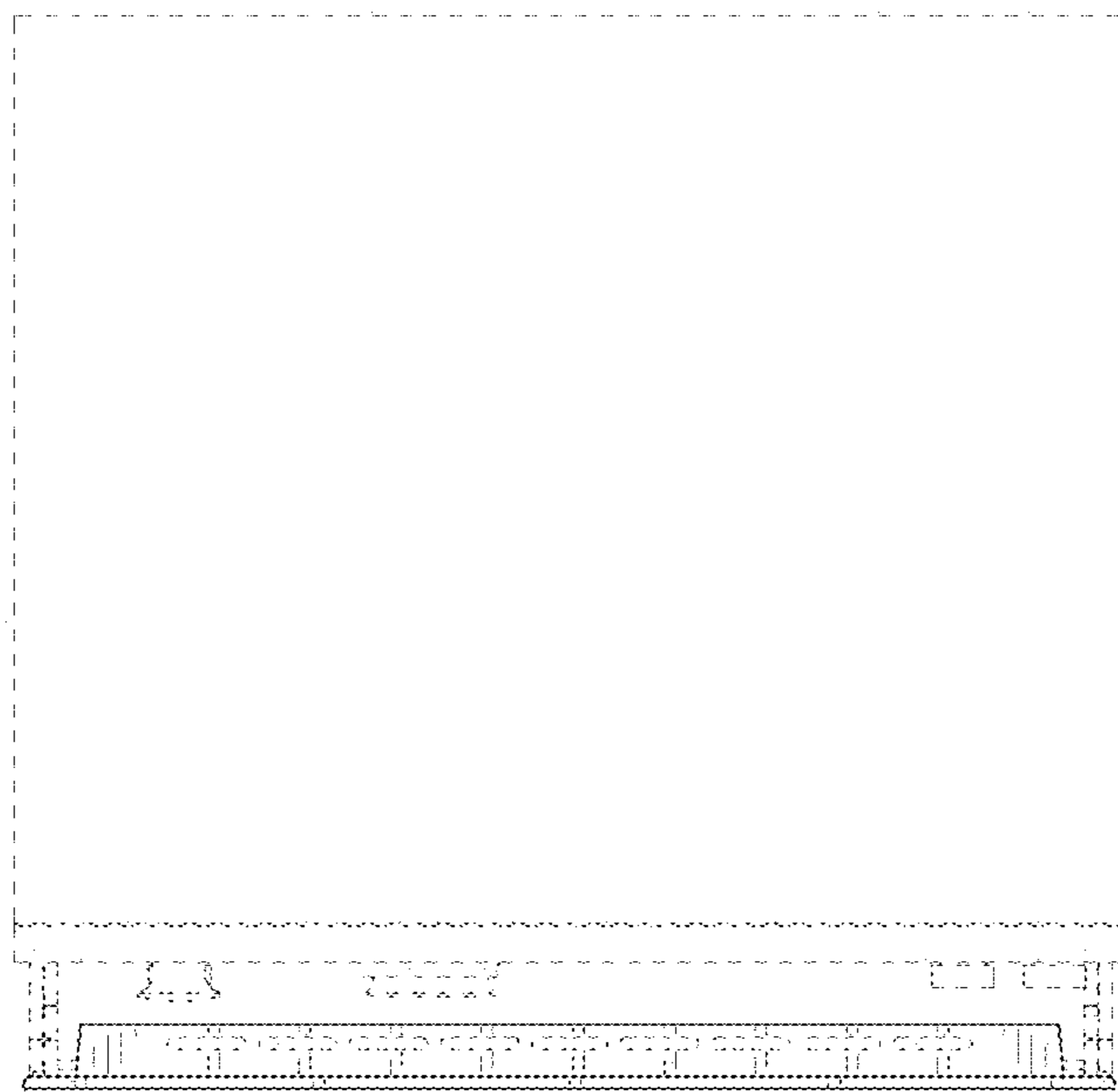

FIG. 7

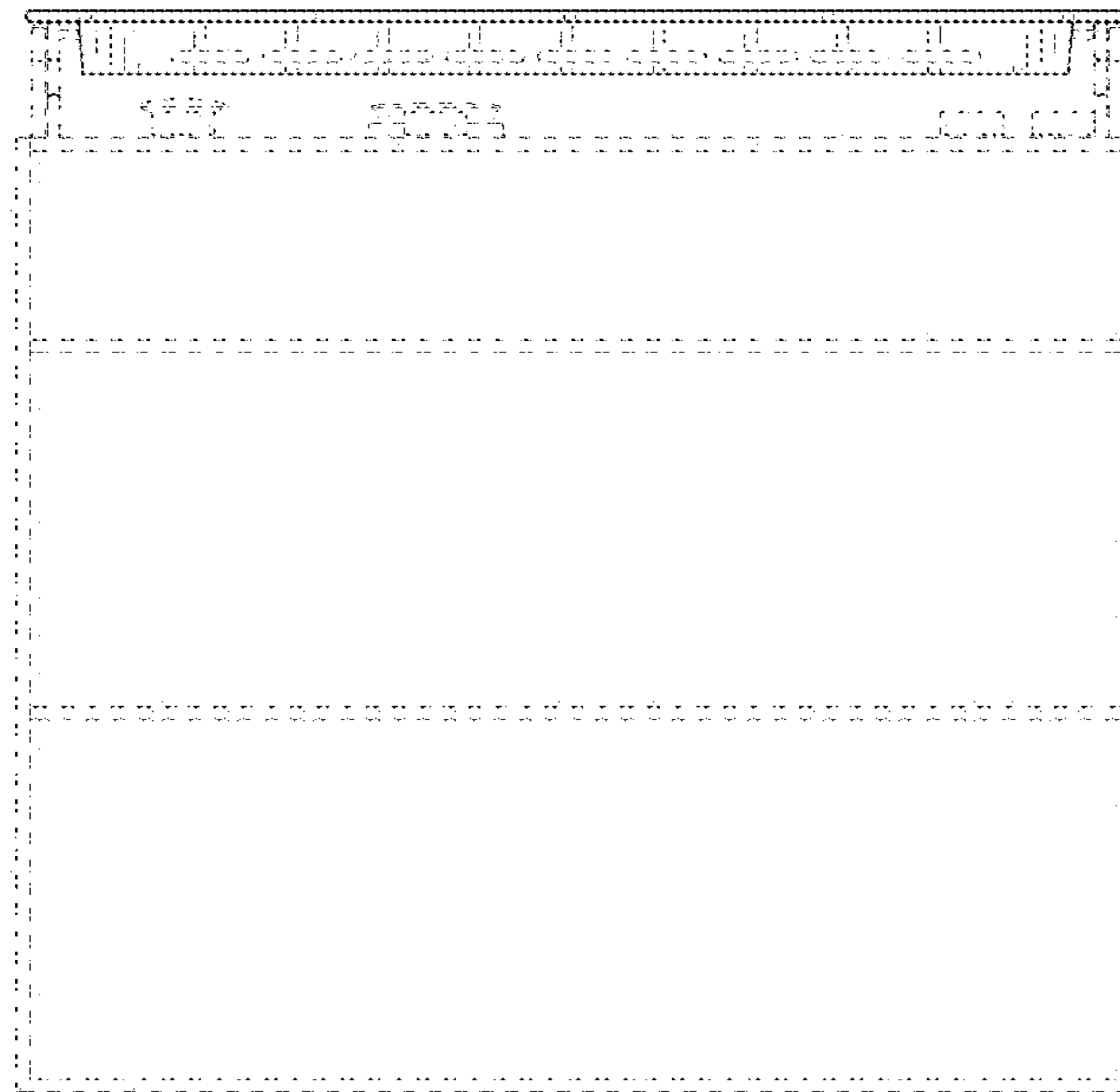

FIG. 8

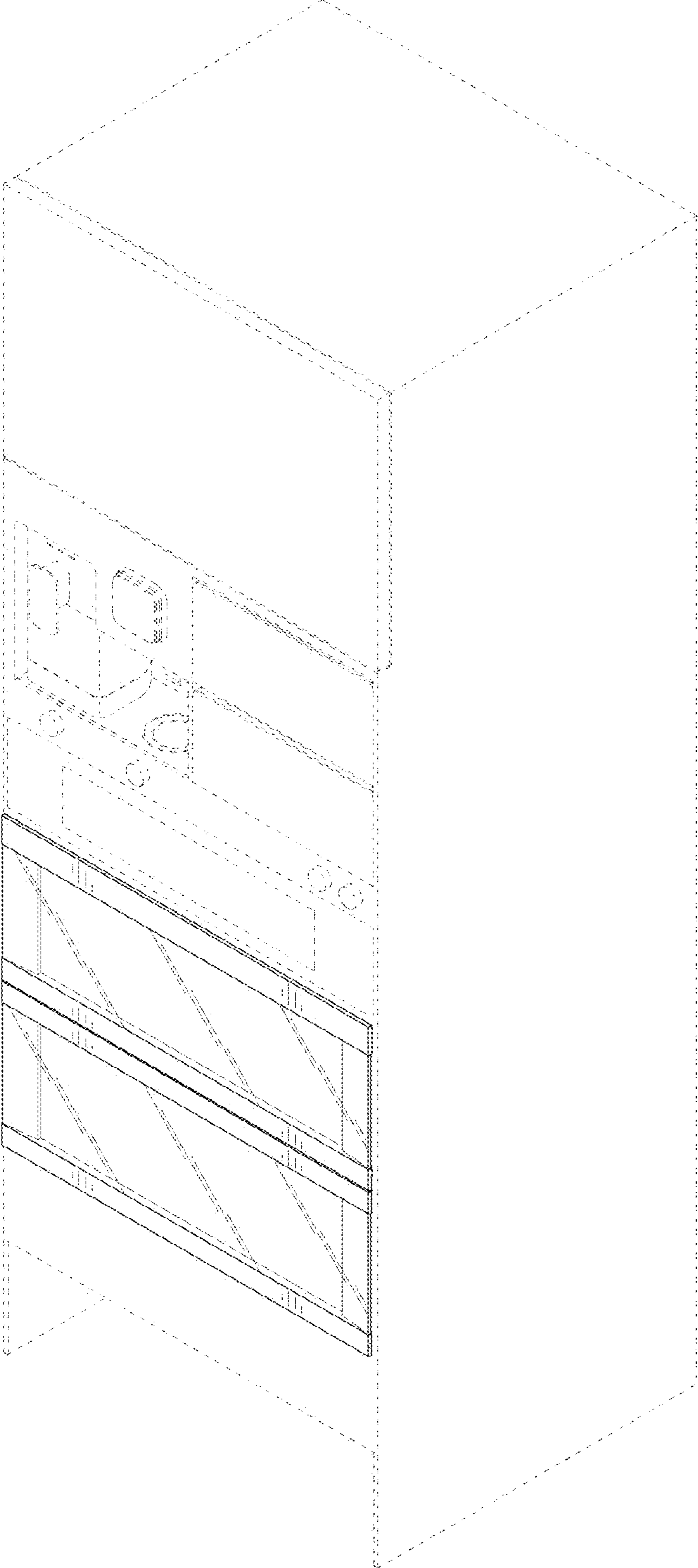

FIG. 9

