



US00D722752S

(12) **United States Design Patent**
Svensson et al.

(10) **Patent No.:** **US D722,752 S**
(45) **Date of Patent:** **** Feb. 24, 2015**

(54) **SOLE AND OUTSOLE ASSEMBLY FOR SKI BOOT**

FOREIGN PATENT DOCUMENTS

EP 0 712 587 A1 5/1996
FR 2 336 152 A1 7/1977

(Continued)

(71) Applicants: **John Erik Svensson**, Vashon, WA (US);
Mark S. Williams, Seattle, WA (US);
James Sener, Glastonbury, CT (US)

OTHER PUBLICATIONS

(72) Inventors: **John Erik Svensson**, Vashon, WA (US);
Mark S. Williams, Seattle, WA (US);
James Sener, Glastonbury, CT (US)

“Cross-Country Skiing,” Wikipedia.org, Jun. 17, 2007, <http://en.wikipedia.org/w/index.php?title=Cross-country_skiing&printable=yes> [retrieved Jun. 20, 2007], 11 pages.

(Continued)

(73) Assignee: **K-2 Corporation**, Seattle, WA (US)

Primary Examiner — T. Chase Nelson

(**) Term: **14 Years**

(74) *Attorney, Agent, or Firm* — Christensen O’Connor Johnson Kindness PLLC

(21) Appl. No.: **29/435,748**

(57) **CLAIM**

(22) Filed: **Oct. 26, 2012**

The ornamental design for a sole and outsole assembly for ski boot, as shown and described.

(51) **LOC (10) CI.** **02-04**

DESCRIPTION

(52) **U.S. CI.**

USPC **D2/957**; D2/951; D2/959

(58) **Field of Classification Search**

USPC D2/902, 906, 908, 916, 918, 925,
D2/946–962, 977; 36/3 B, 22 R, 24.5, 25 R,
36/28, 32 R, 34 R, 59 C, 67 A, 103

See application file for complete search history.

(56) **References Cited**

U.S. PATENT DOCUMENTS

4,088,342 A	5/1978	Hausleithner	
4,499,674 A	2/1985	Olivieri	
4,562,653 A	1/1986	Salomon	
4,839,972 A	6/1989	Pack	
5,066,036 A	11/1991	Broughton	
D357,570 S *	4/1995	Parisotto	D2/904
D385,987 S *	11/1997	Bramani	D2/959
5,794,950 A *	8/1998	Svensson et al.	280/11.214

(Continued)

1 Claim, 7 Drawing Sheets

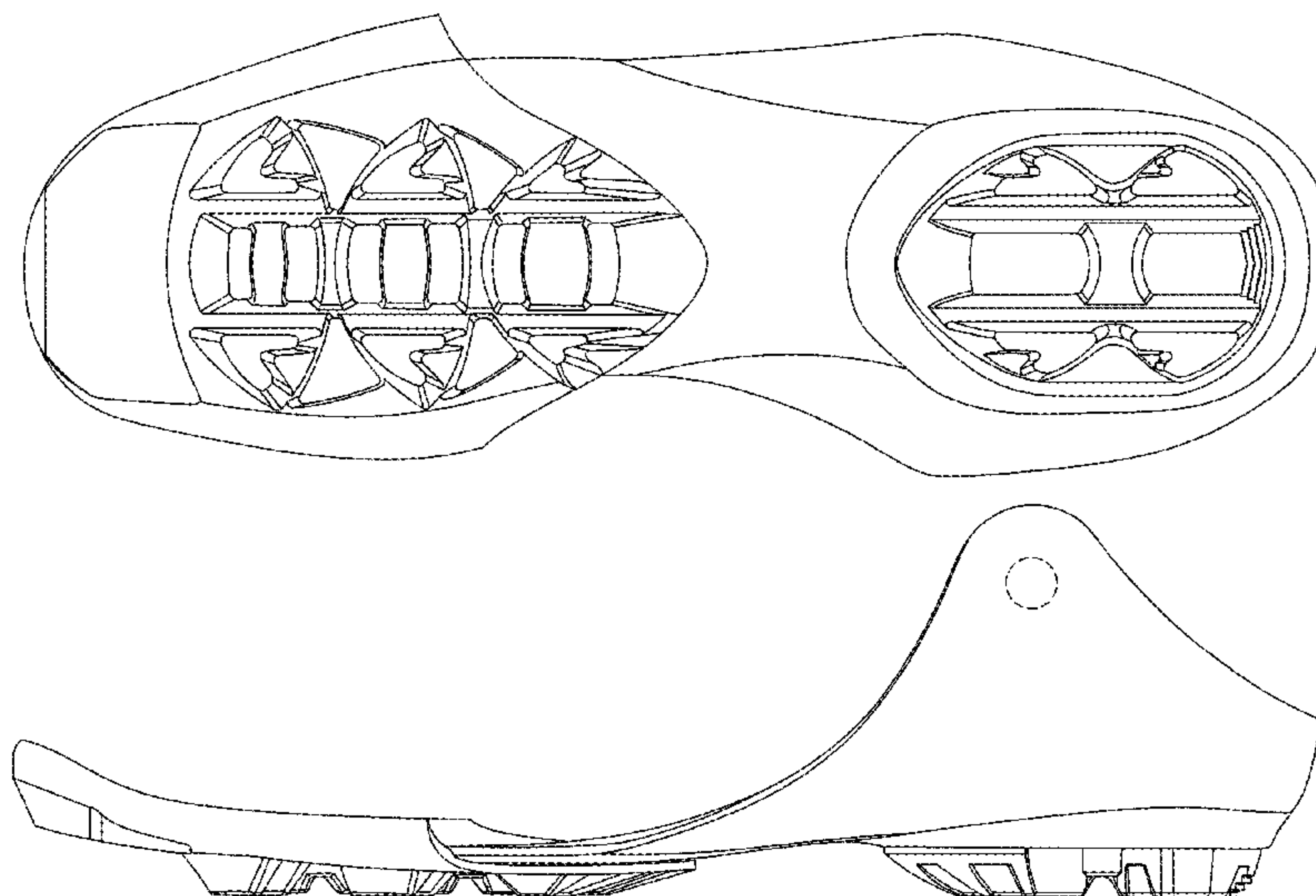

(56)

References Cited

U.S. PATENT DOCUMENTS

5,797,610 A * 8/1998 Grande et al. 280/11.202
 D404,187 S * 1/1999 Meibock et al. D2/804
 D410,692 S * 6/1999 Bailey D2/904
 5,992,861 A 11/1999 Piotrowski
 6,012,726 A * 1/2000 Grande et al. 280/11.231
 6,082,744 A 7/2000 Allinger
 6,168,184 B1 1/2001 Simonetti
 6,202,326 B1 3/2001 Hauglin
 D447,854 S * 9/2001 Rogers D2/957
 D450,914 S * 11/2001 Wilson D2/959
 D461,946 S * 8/2002 Burt D2/951
 D462,157 S * 9/2002 Burt D2/953
 6,499,748 B2 * 12/2002 Meibock et al. 280/11.221
 D468,083 S * 1/2003 Morais D2/960
 D471,697 S * 3/2003 Laberge D2/960
 D475,111 S * 5/2003 Bennett D21/764
 D485,423 S * 1/2004 Truelsen D2/953
 6,685,213 B2 2/2004 Hauglin
 D488,294 S * 4/2004 Lancon D2/957
 D490,596 S * 6/2004 Belley et al. D2/957
 D509,345 S * 9/2005 Munns D2/957
 6,971,652 B2 12/2005 Bobbert
 D530,891 S * 10/2006 Matis et al. D2/953
 D531,394 S * 11/2006 Bonnemere D2/957
 D550,436 S * 9/2007 Matis et al. D2/953
 D552,335 S * 10/2007 Matis et al. D2/957
 D556,985 S * 12/2007 Schoenborn et al. D2/953
 D564,192 S * 3/2008 Covatch D2/959
 D564,740 S * 3/2008 Matis et al. D2/957
 D564,741 S * 3/2008 Covatch D2/957
 D566,938 S * 4/2008 Matis et al. D2/957
 D566,940 S * 4/2008 Schoenborn et al. D2/957
 D567,492 S * 4/2008 Belley et al. D2/957
 D604,488 S * 11/2009 Amphyon D2/953
 D608,537 S * 1/2010 Anderson D2/960
 D622,041 S * 8/2010 Richard D2/953

D622,043 S * 8/2010 Hauglin D2/957
 D655,902 S * 3/2012 Debiase D2/957
 D659,970 S * 5/2012 Liao D2/962
 D662,695 S * 7/2012 Mcvicker et al. D2/902
 D670,491 S * 11/2012 Ko et al. D2/962
 D671,718 S * 12/2012 McVicker et al. D2/908
 D677,453 S * 3/2013 Sakai D2/959
 D680,723 S * 4/2013 Joseph D2/957
 D684,755 S * 6/2013 Miette D2/957
 D688,035 S * 8/2013 Recchi et al. D2/957
 D689,275 S * 9/2013 Mahoney D2/959
 D695,505 S * 12/2013 Hansen D2/960
 D702,032 S * 4/2014 Nakano D2/959
 D708,828 S * 7/2014 Avar et al. D2/947
 2005/0280221 A1 12/2005 Haugen
 2005/0280222 A1 12/2005 Sauter
 2012/0151801 A1 6/2012 Miette

FOREIGN PATENT DOCUMENTS

FR 2 358 117 A1 2/1978
 WO 99/21625 A1 5/1999
 WO 02/052969 A1 7/2002

OTHER PUBLICATIONS

Hale, P., "NIS: A Revolution in Nordic Bindings," Skinny Skis C-Corp, Jan. 17, 2006, <<http://www.skinnyskis.com/article.aspx?id=10003>> [retrieved Jun. 20, 2007], 3 pages.
 Muha, M., "Nordic Integrated System," NordicSkiRacer.com, Jan. 26, 2005, <<http://www.nordicskiracer.com/Equipment/2005/NIS/NIS.asp>> [retrieved Jun. 20, 2007], 5 pages.
 "NIS—Nordic Integrated System," Madshus, n. d., <<http://www.madshus.com/mhtemplates/Page.aspx?id=332>> [retrieved Jun. 20, 2007], 2 pages.
 Svensson, J.E., "Ski Boot," U.S. Appl. No. 13/316,408, filed Dec. 9, 2011.

* cited by examiner

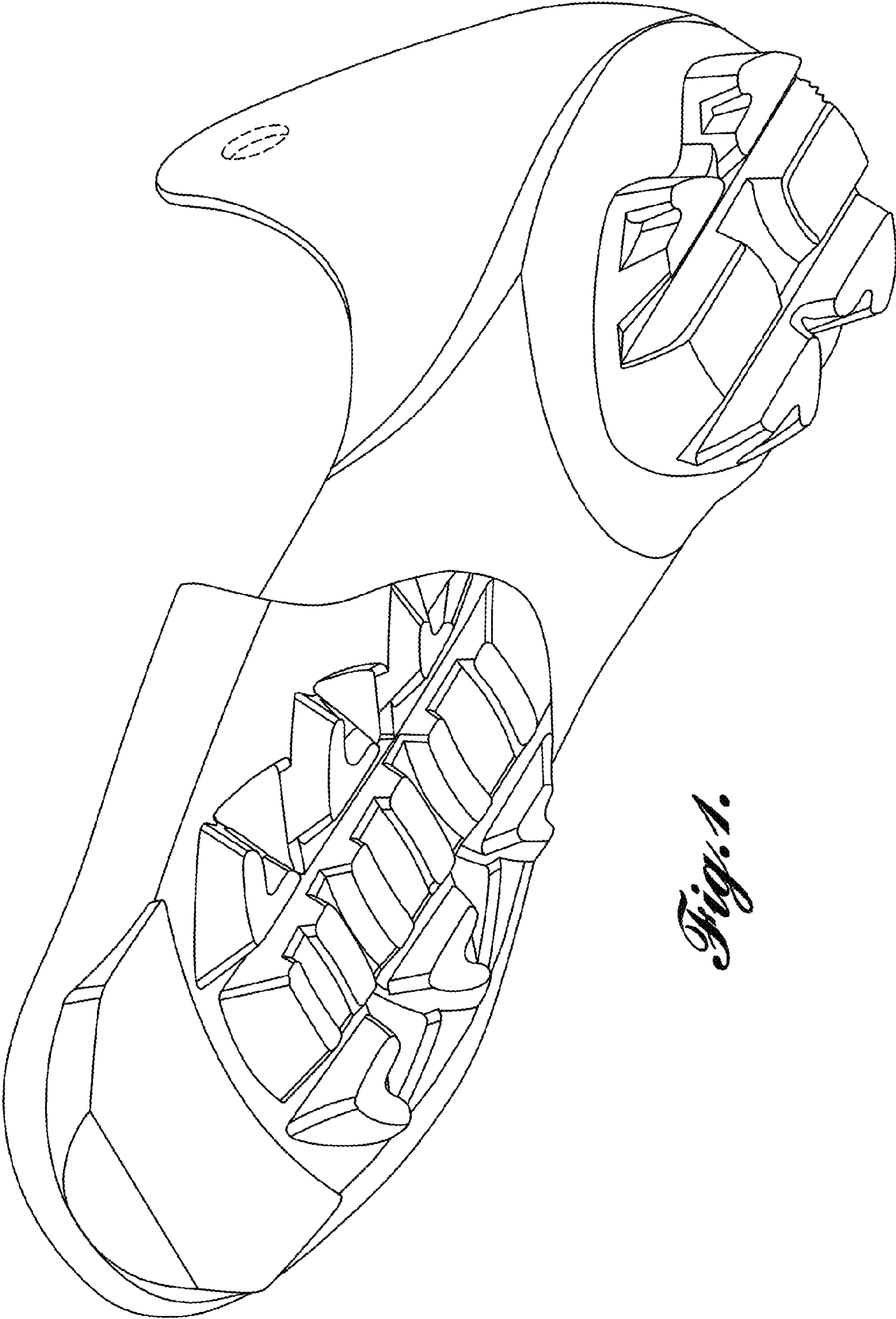

Fig. 1.

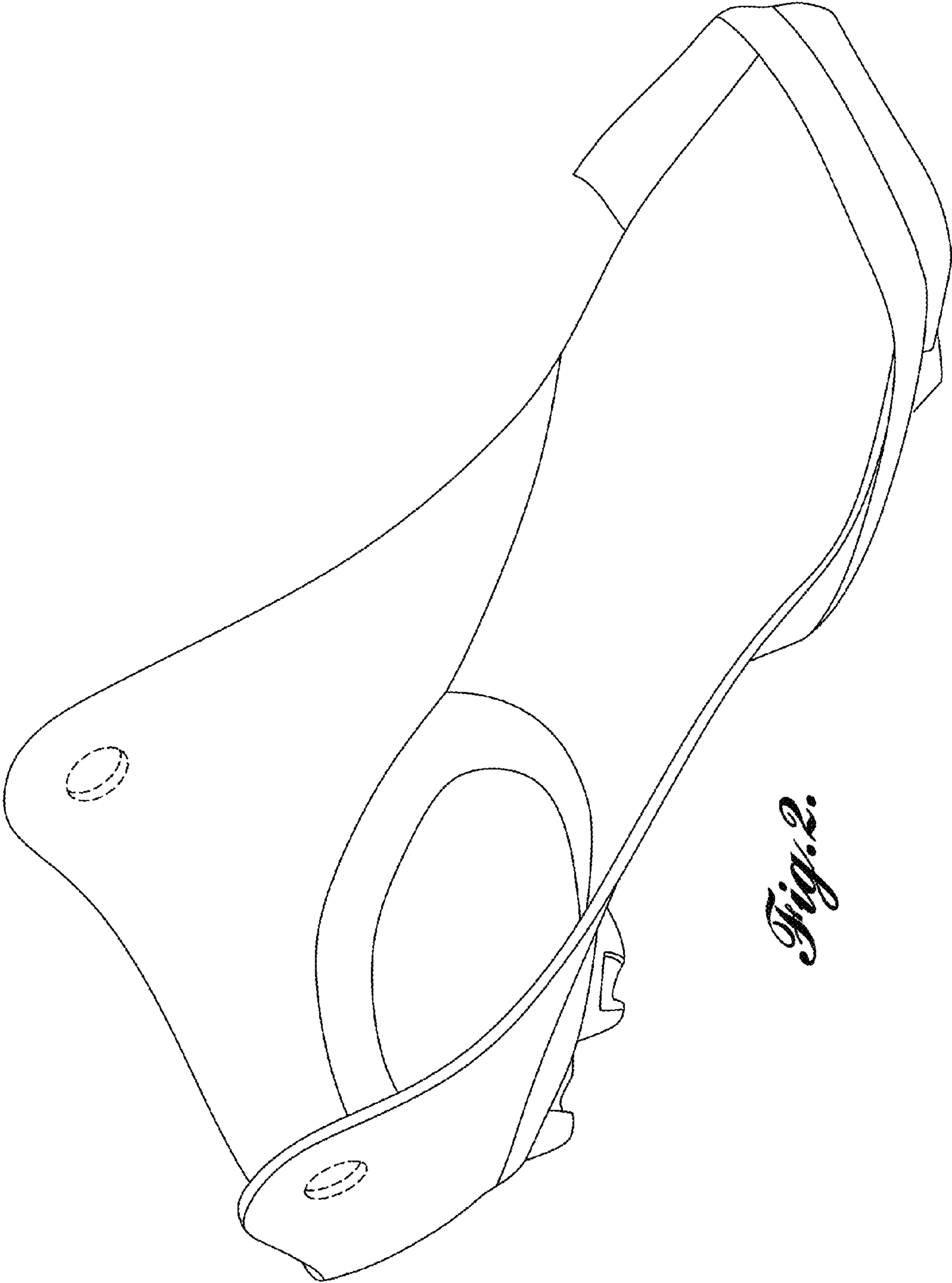

Fig. 2.

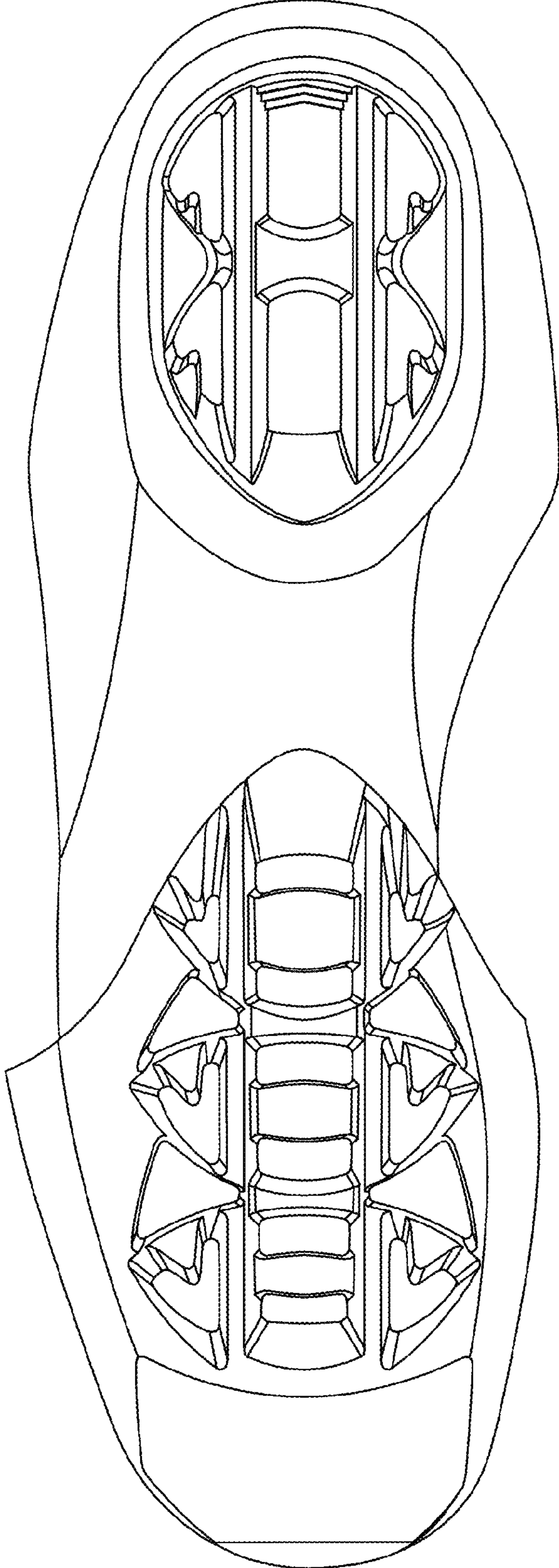

Fig. 3.

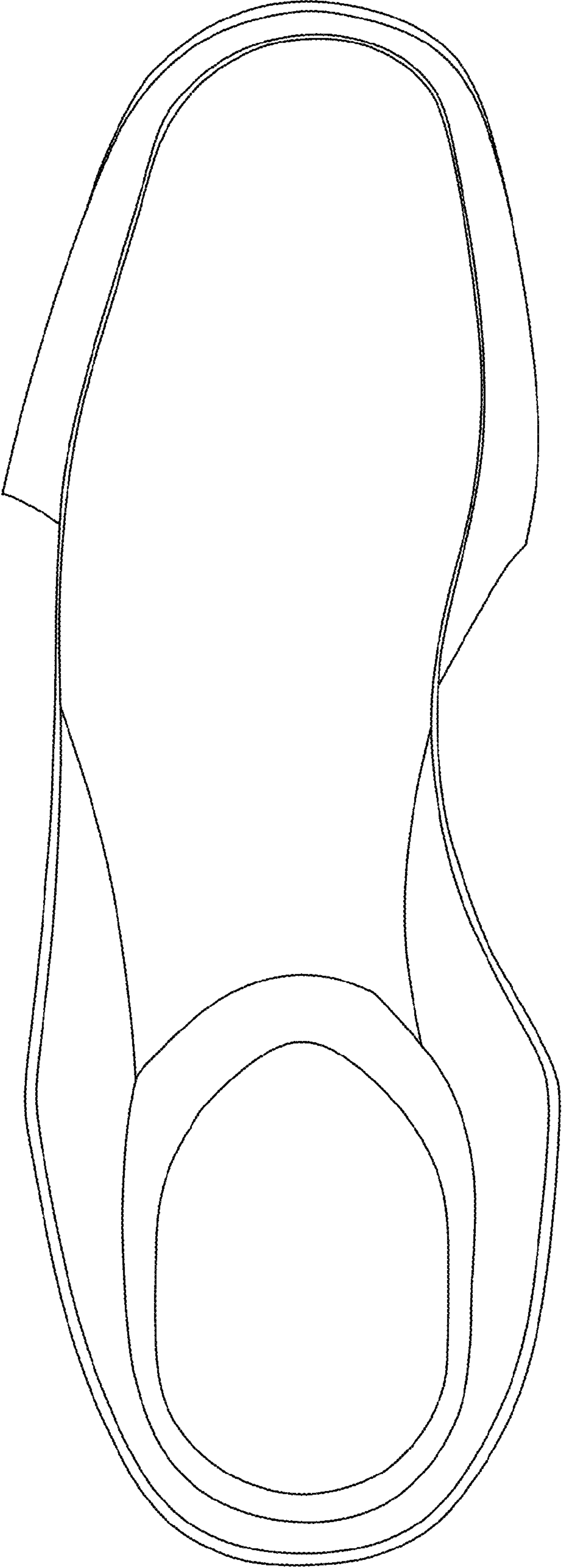

Fig. 4.

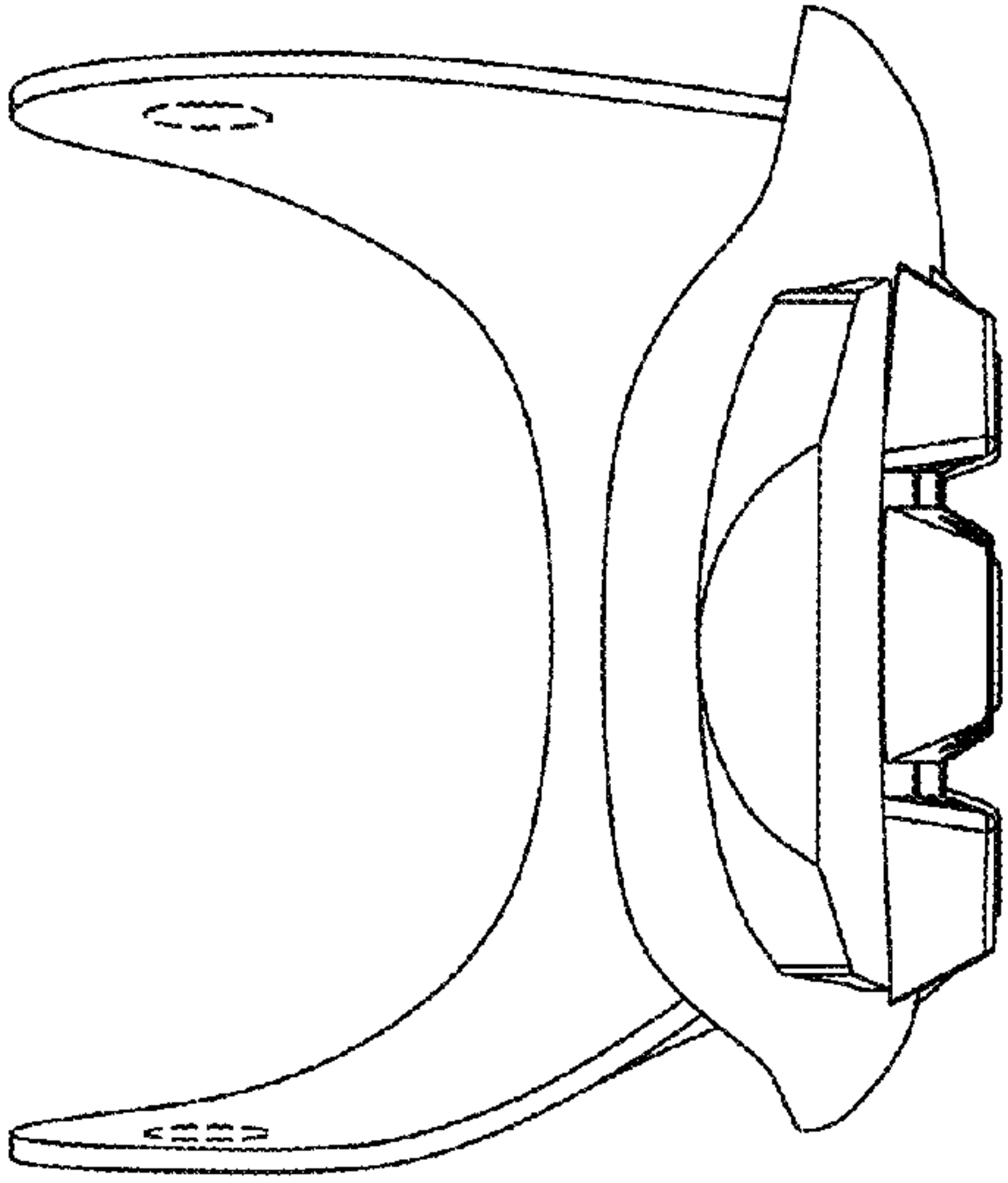

Fig. 5.

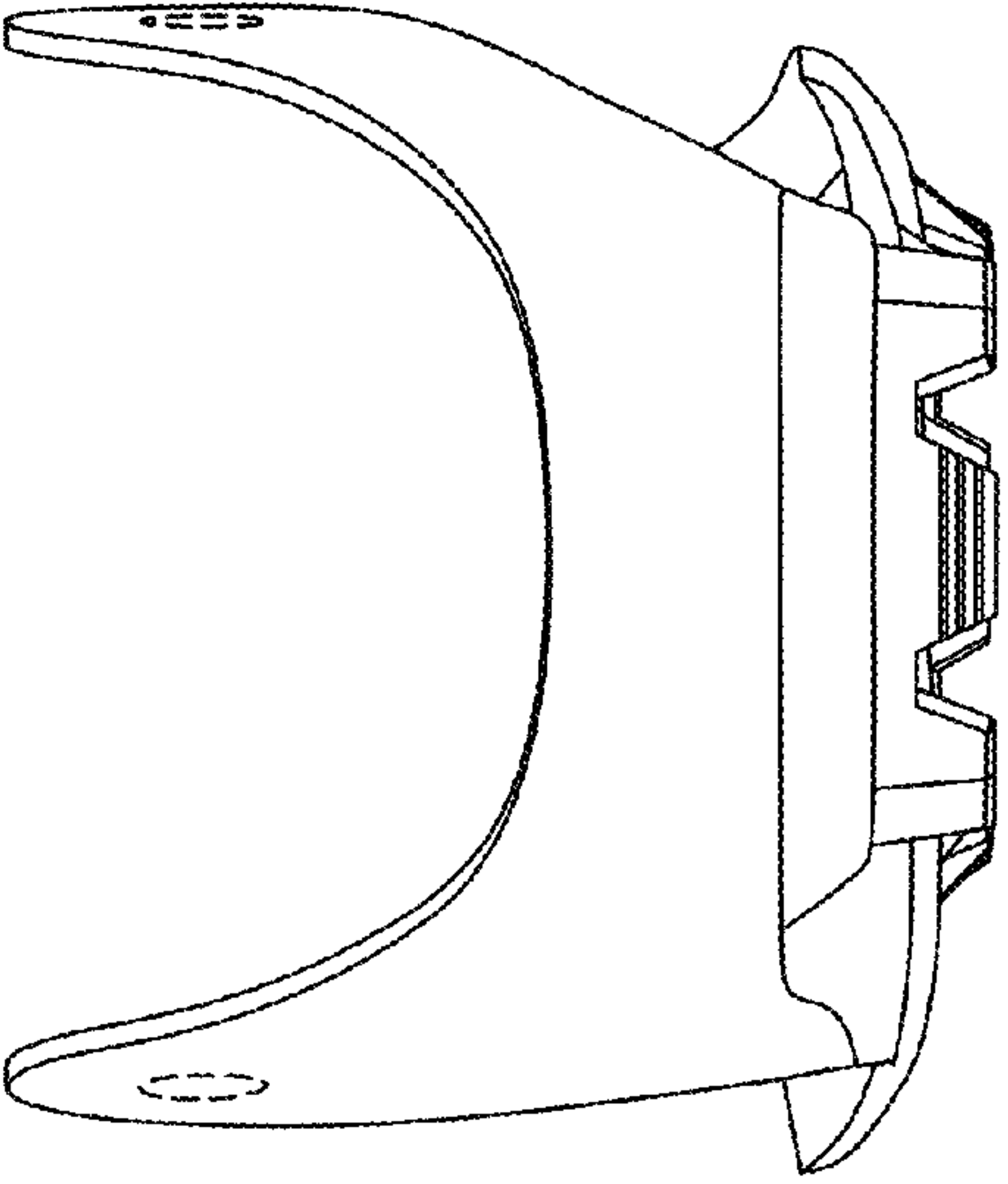

Fig. 6.



Fig. 7.



Fig. 8.