



US00D722732S

(12) **United States Design Patent**
Ghim et al.

(10) **Patent No.:** **US D722,732 S**

(45) **Date of Patent:** **** Feb. 17, 2015**

(54) **VACUUM CLEANER**

(71) Applicant: **LG Electronics Inc.**, Seoul (KR)

(72) Inventors: **Yonggyun Ghim**, Seoul (KR); **Hanjin Jung**, Gyeonggi-do (KR)

(73) Assignee: **LG Electronics Inc.**, Seoul (KR)

(**) Term: **14 Years**

(21) Appl. No.: **29/483,977**

(22) Filed: **Mar. 5, 2014**

(30) **Foreign Application Priority Data**

Sep. 5, 2013 (KR) 30-2013-0045961

(51) **LOC (10) Cl.** **15-05**

(52) **U.S. Cl.**
USPC **D32/21**

(58) **Field of Classification Search**
CPC A47L 7/0038; A47L 5/36-5/367;
A47L 5/24; A47L 5/14; A47L 5/28; A47L
7/0019; A47L 7/0023; A47L 7/0004; A47L
9/1666; A47L 9/1683; A47L 11/34; A47L
11/4072; A47L 9/009; A47L 11/40
USPC 301/95.101, 105.1, 5.1; D12/501, 204,
D12/208; D32/21, 23-24, 31

See application file for complete search history.

(56) **References Cited**

U.S. PATENT DOCUMENTS

D550,910 S *	9/2007	Shin	D32/21
D551,403 S *	9/2007	Shin	D32/21
D553,311 S *	10/2007	Shin	D32/21
D553,812 S *	10/2007	Shin	D32/21
D554,308 S *	10/2007	Shin	D32/21
D565,813 S *	4/2008	Shin	D32/21
D582,110 S *	12/2008	Baek	D32/21
D620,653 S *	7/2010	Lee et al.	D32/21
D620,654 S *	7/2010	Kim	D32/21
D653,823 S *	2/2012	Kim et al.	D32/21

* cited by examiner

Primary Examiner — Ruth McInroy

(74) *Attorney, Agent, or Firm* — Morgan, Lewis & Bockius LLP

(57) **CLAIM**

The ornamental design for a vacuum cleaner, as shown and described.

DESCRIPTION

FIG. 1 is a front, right side, perspective view of a vacuum cleaner showing our new design; FIG. 2 is a front view thereof; FIG. 3 is a rear view thereof; FIG. 4 is a left side view thereof; FIG. 5 is a right side view thereof; FIG. 6 is a top view thereof; and, FIG. 7 is a bottom view thereof.

The broken lines in the drawings indicate unclaimed portions of the vacuum cleaner that form no part of the claimed design.

1 Claim, 7 Drawing Sheets

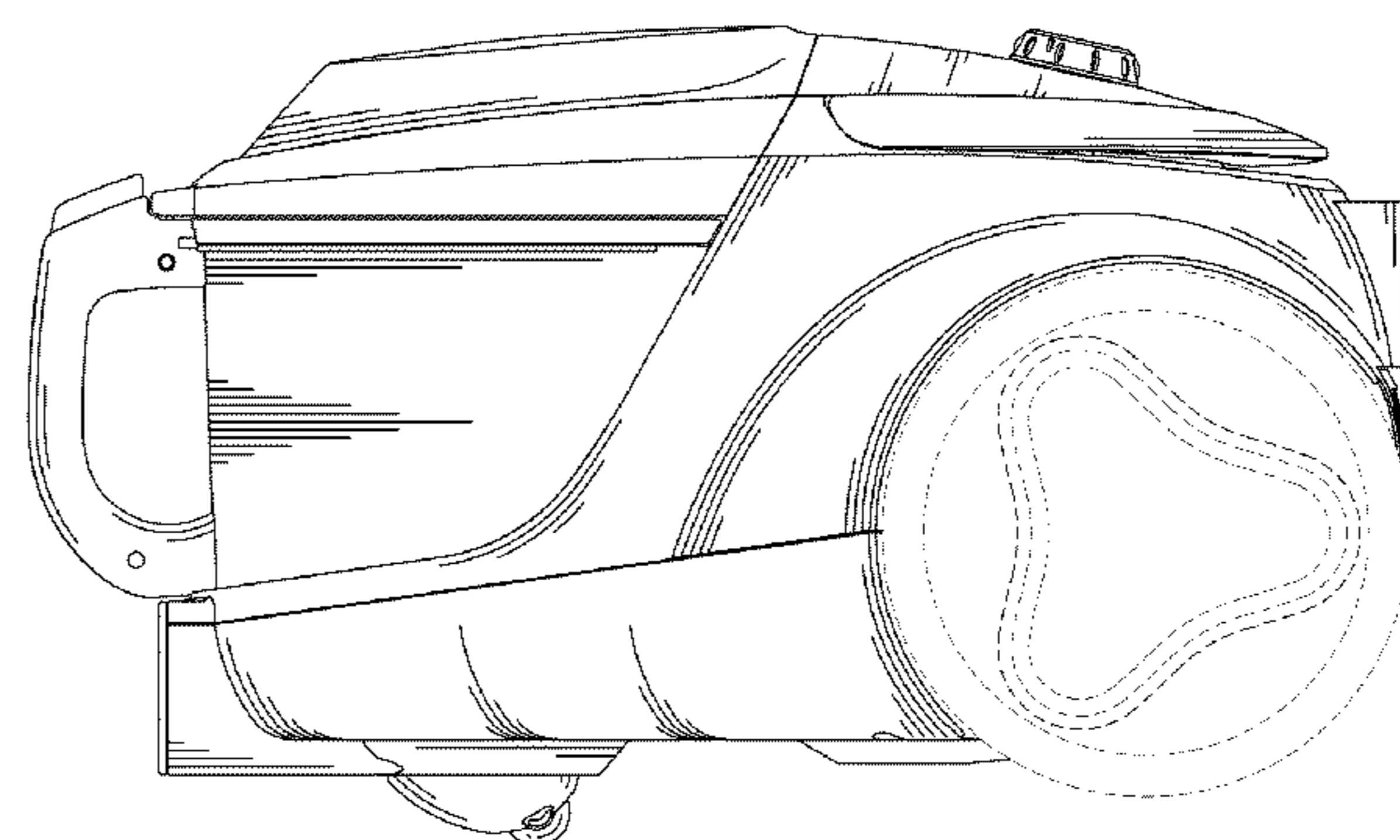
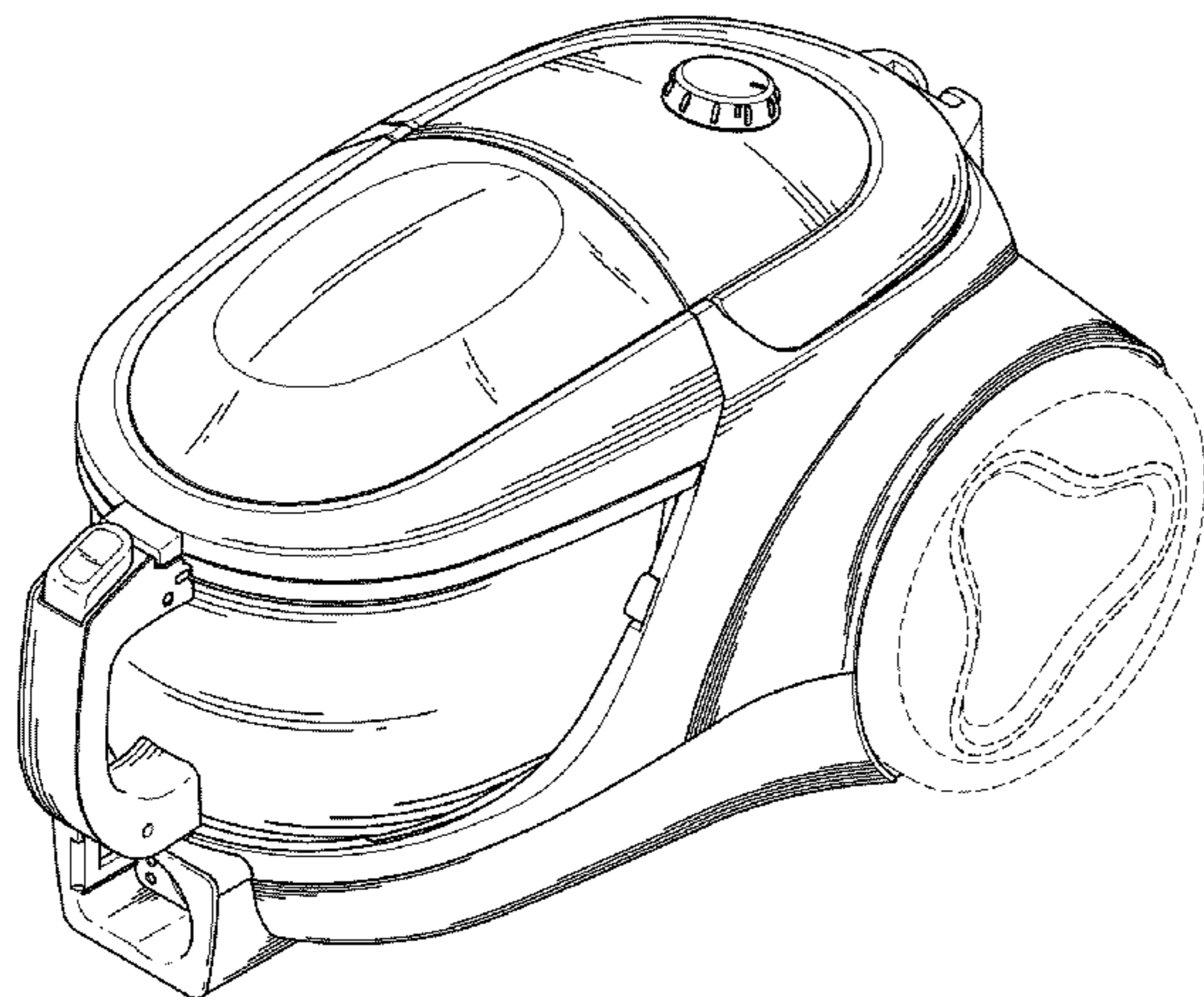

FIG. 1

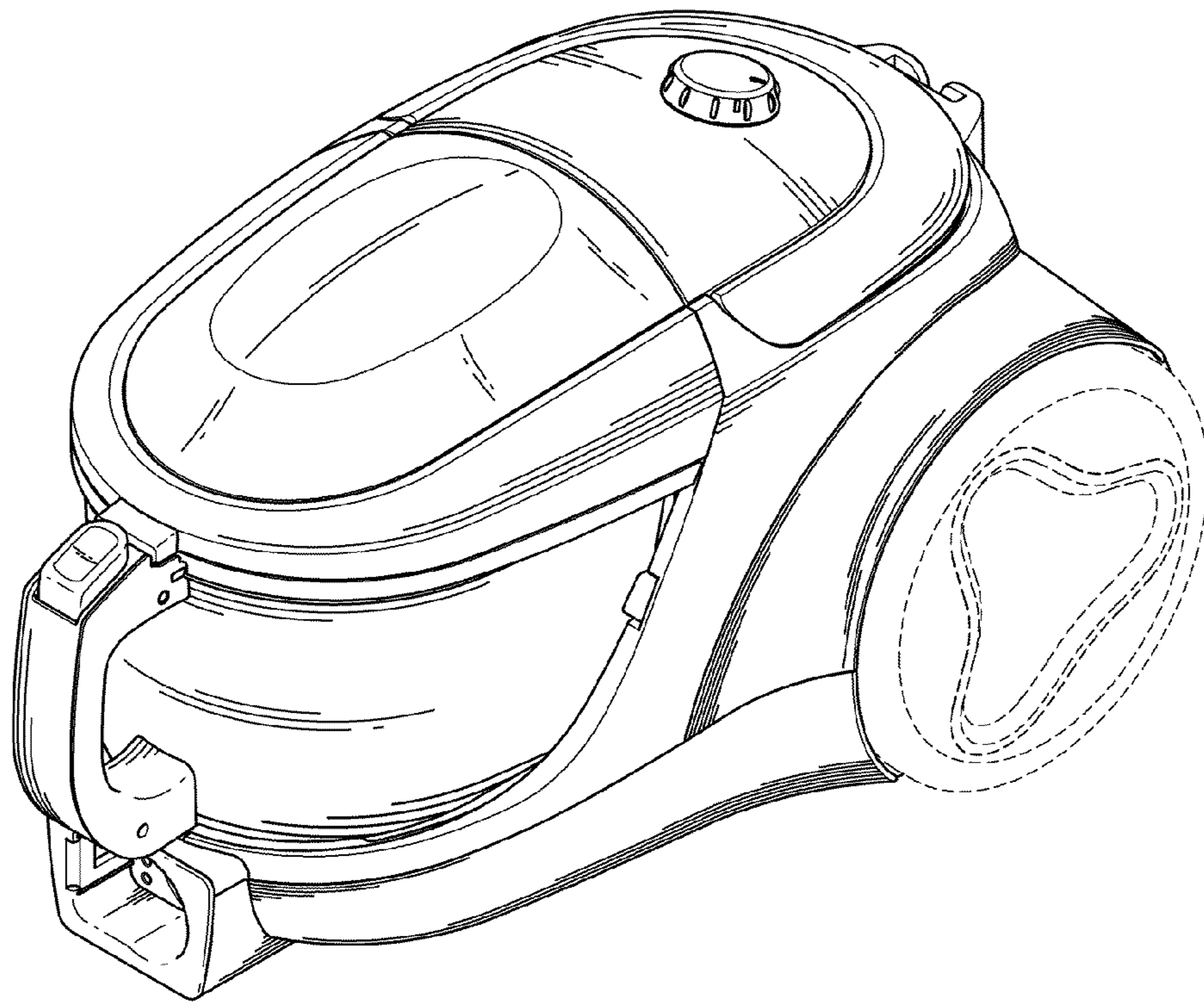

FIG. 2

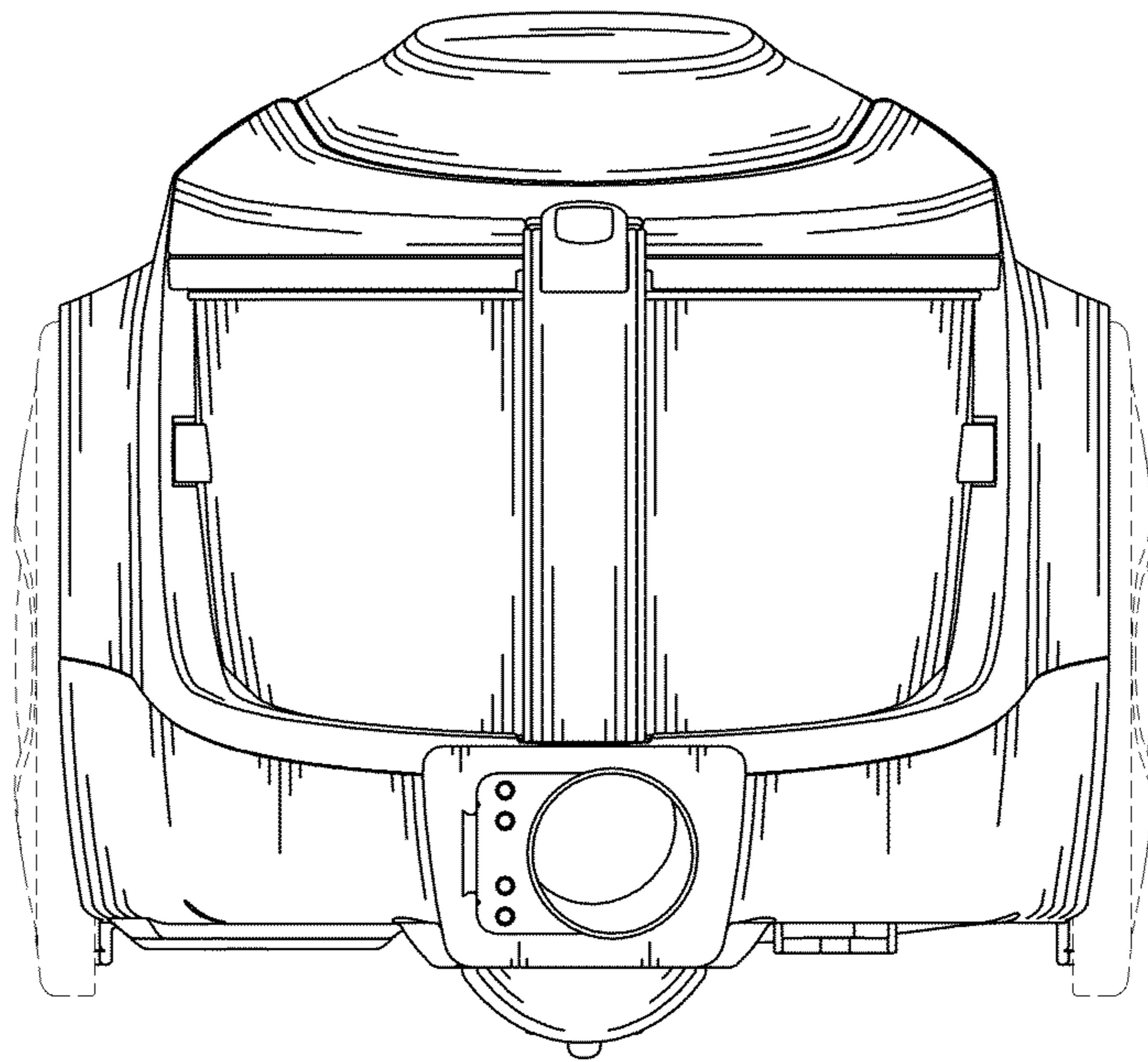

FIG. 3

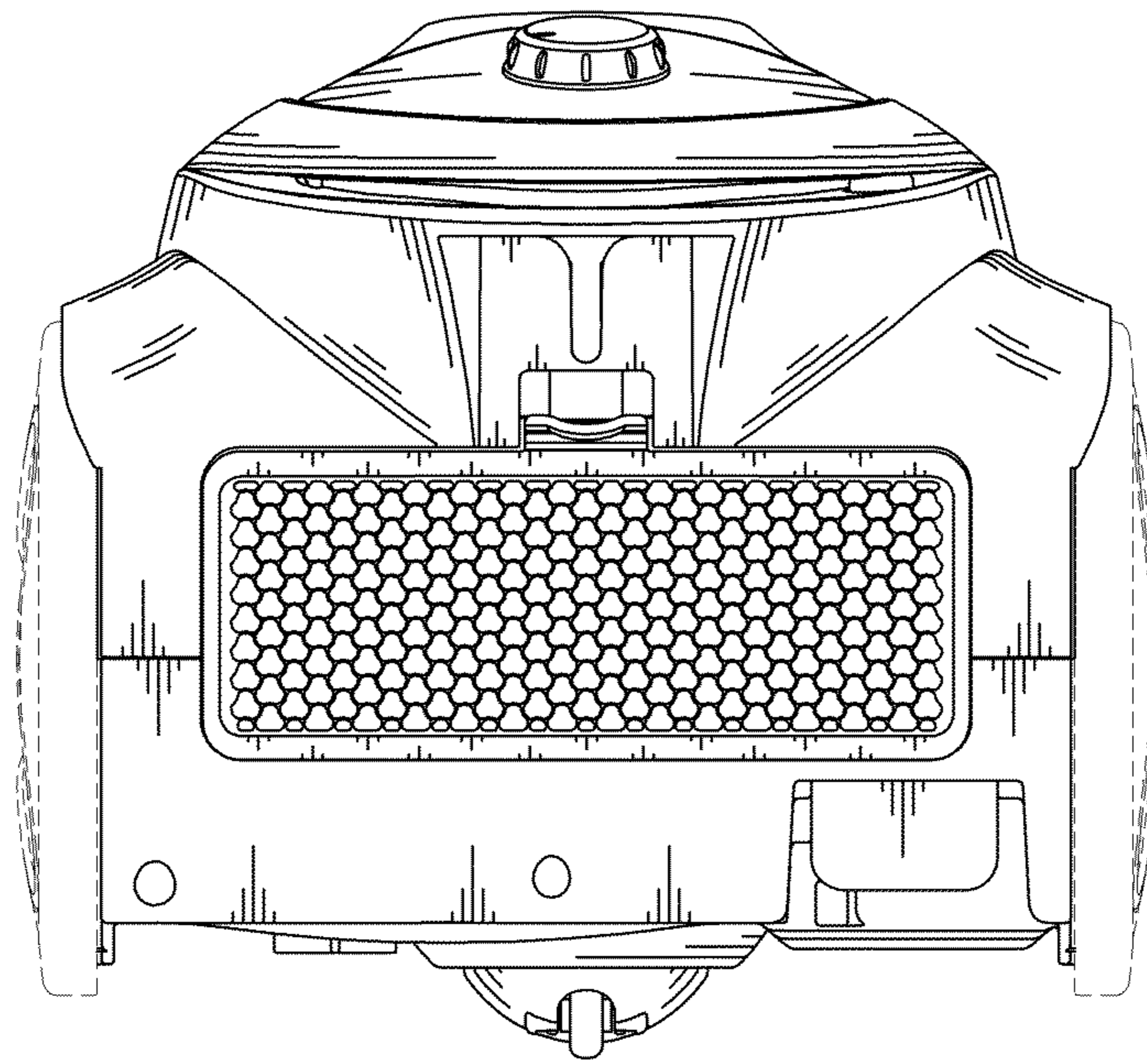

FIG. 4

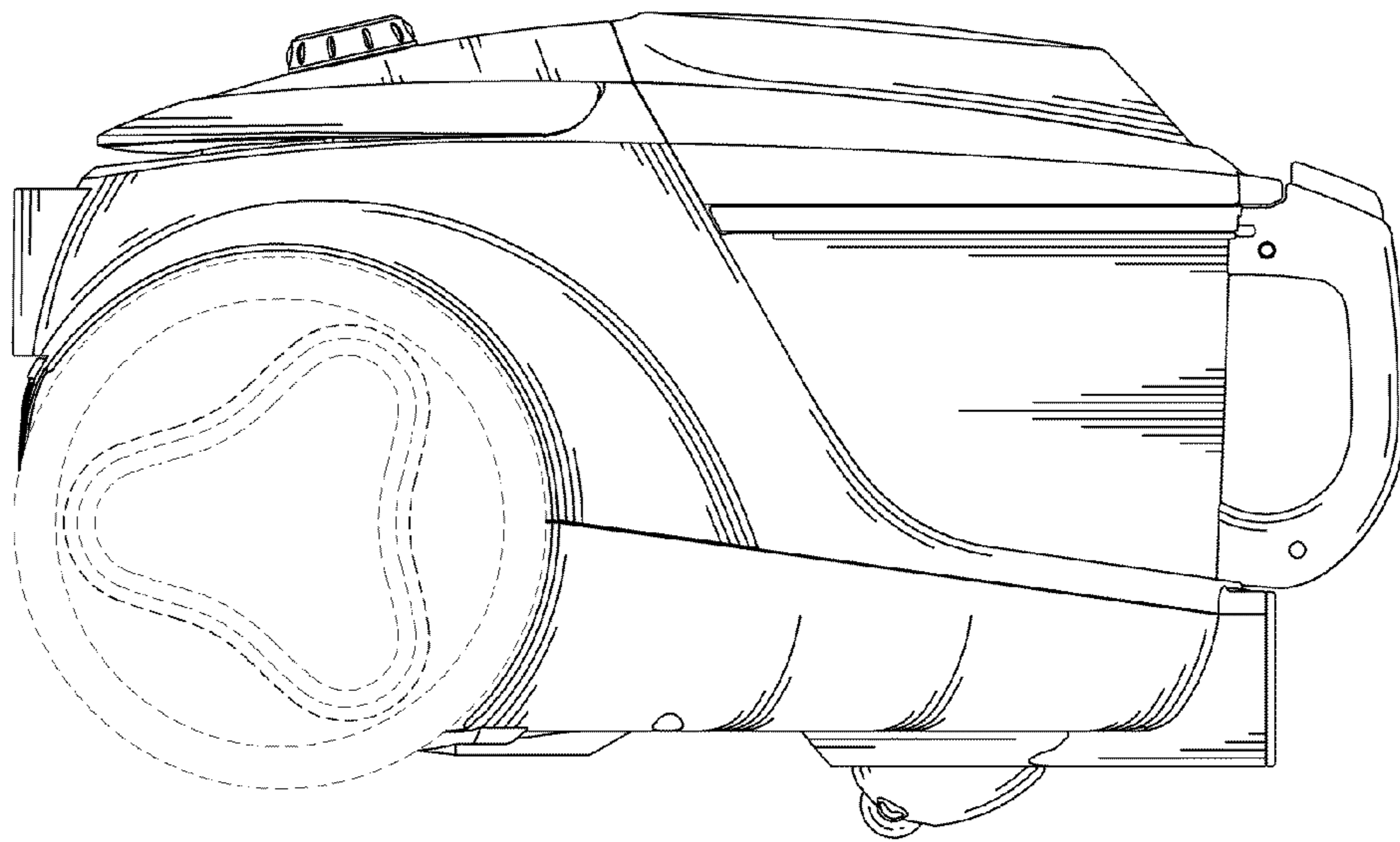

FIG. 5

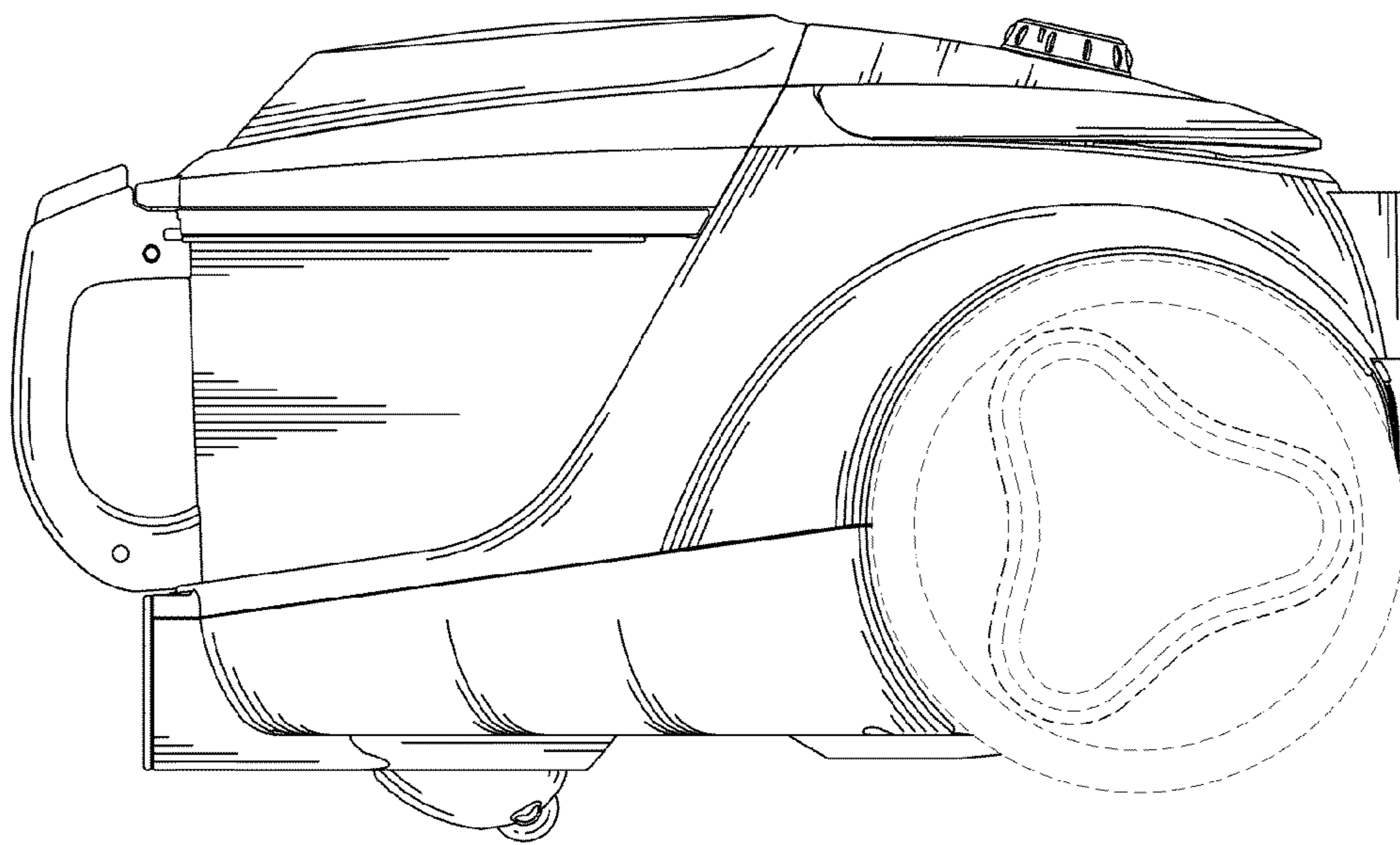

FIG. 6

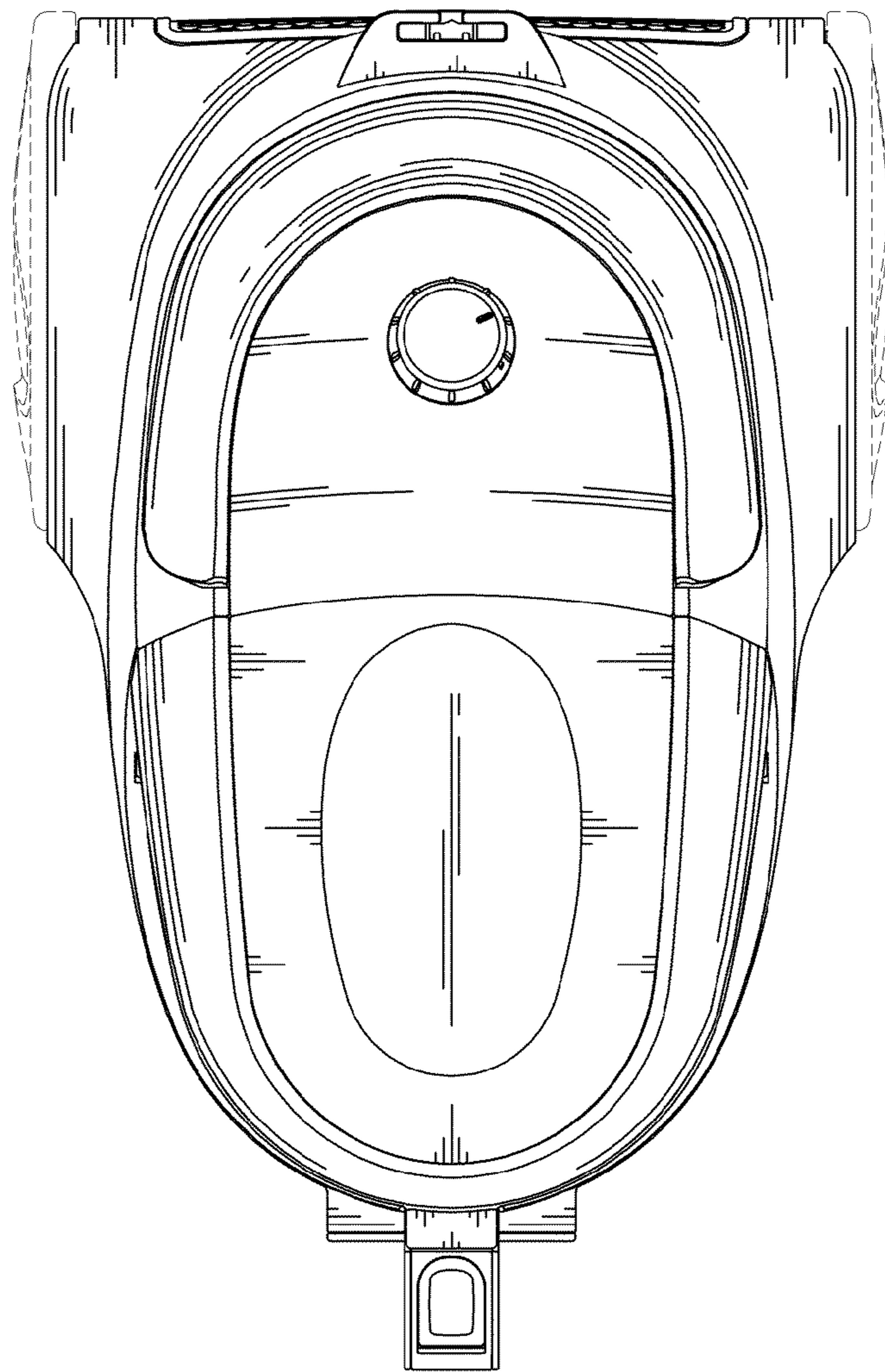

FIG. 7

