



US00D722716S

(12) **United States Design Patent**
Pamani

(10) **Patent No.:** **US D722,716 S**

(45) **Date of Patent:** **** Feb. 17, 2015**

(54) **LANTERN WITH BUILT IN RADIO AND FLASHLIGHT**

(75) Inventor: **Ramesh Pamani**, Moonachie, NJ (US)

(73) Assignee: **Style Asia Inc.**, Moonachie, NJ (US)

(**) Term: **14 Years**

(21) Appl. No.: **29/424,675**

(22) Filed: **Jun. 14, 2012**

(51) **LOC (10) Cl.** **26-02**

(52) **U.S. Cl.**
USPC **D26/41**

(58) **Field of Classification Search**
USPC D26/37, 38, 39, 40, 42, 46, 51, 52, 41;
362/157, 158, 183, 194-196, 200-208,
362/253

See application file for complete search history.

(56) **References Cited**

U.S. PATENT DOCUMENTS

D118,504 S *	1/1940	Punke	D26/52
D149,022 S *	3/1948	Robinson, Jr.	D26/52
D153,269 S *	4/1949	Engle	D26/52
D313,666 S *	1/1991	D'Alleva	D26/52
D351,246 S *	10/1994	Yuen	D26/52
D370,285 S *	5/1996	Widdup	D26/52
D451,220 S *	11/2001	Long et al.	D26/37
D462,469 S *	9/2002	Poon	D26/37
D486,931 S *	2/2004	Lee	D26/38
D505,128 S *	5/2005	Lam	D14/168
D509,920 S *	9/2005	Fritz et al.	D26/40
D524,968 S *	7/2006	Poon	D26/40

D537,966 S *	3/2007	Lo et al.	D26/40
D548,864 S *	8/2007	Lee	D26/38
D553,774 S *	10/2007	Leung et al.	D26/40
D556,928 S *	12/2007	Poon	D26/40
D564,112 S *	3/2008	Jen	D26/40
D616,578 S *	5/2010	Leung et al.	D26/41
D650,105 S *	12/2011	Crawford et al.	D26/41

* cited by examiner

Primary Examiner — Ian Simmons

Assistant Examiner — Carissa C Fitts

(74) *Attorney, Agent, or Firm* — Galgano & Associates, PLLC; Thomas M. Galgano; Jessica G. Bower

(57) **CLAIM**

The ornamental design for a lantern with built in radio and flashlight, as shown and described.

DESCRIPTION

FIG. 1 is a front and left side perspective view of a lantern with built in radio and flashlight, showing my new design, with the controls and lighting elements shown in phantom; FIG. 2 is a front elevational view thereof; FIG. 3 is a rear elevational view thereof; FIG. 4 is a left side elevational view thereof; FIG. 5 is a right side elevational view thereof; FIG. 6 is a top plan thereof; and, FIG. 7 is a bottom plan view thereof with the feet and battery compartment shown in phantom. The broken line is included for the purpose of illustrating portions of the lantern and forms no part of the claimed design.

1 Claim, 7 Drawing Sheets

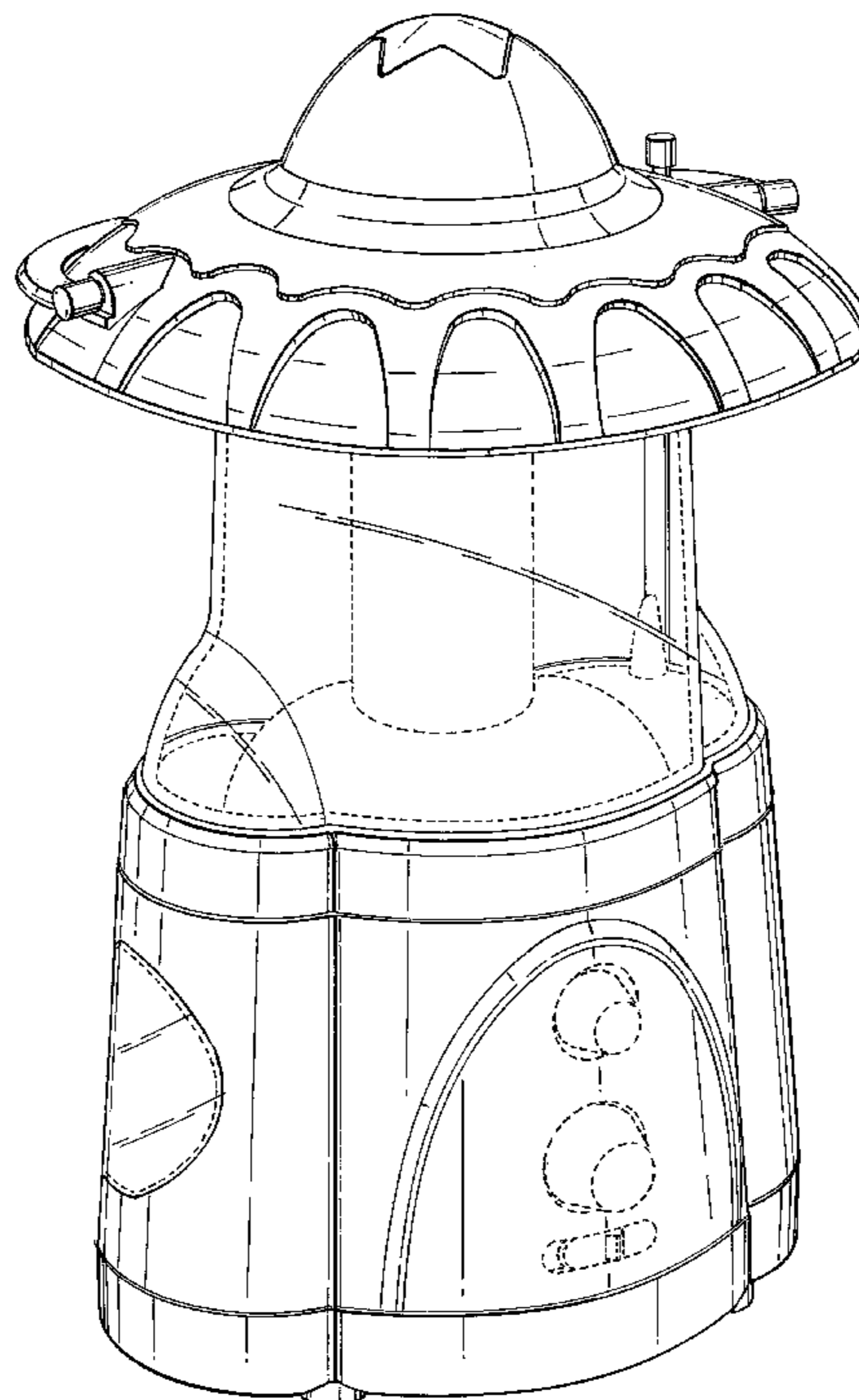

Fig. 1

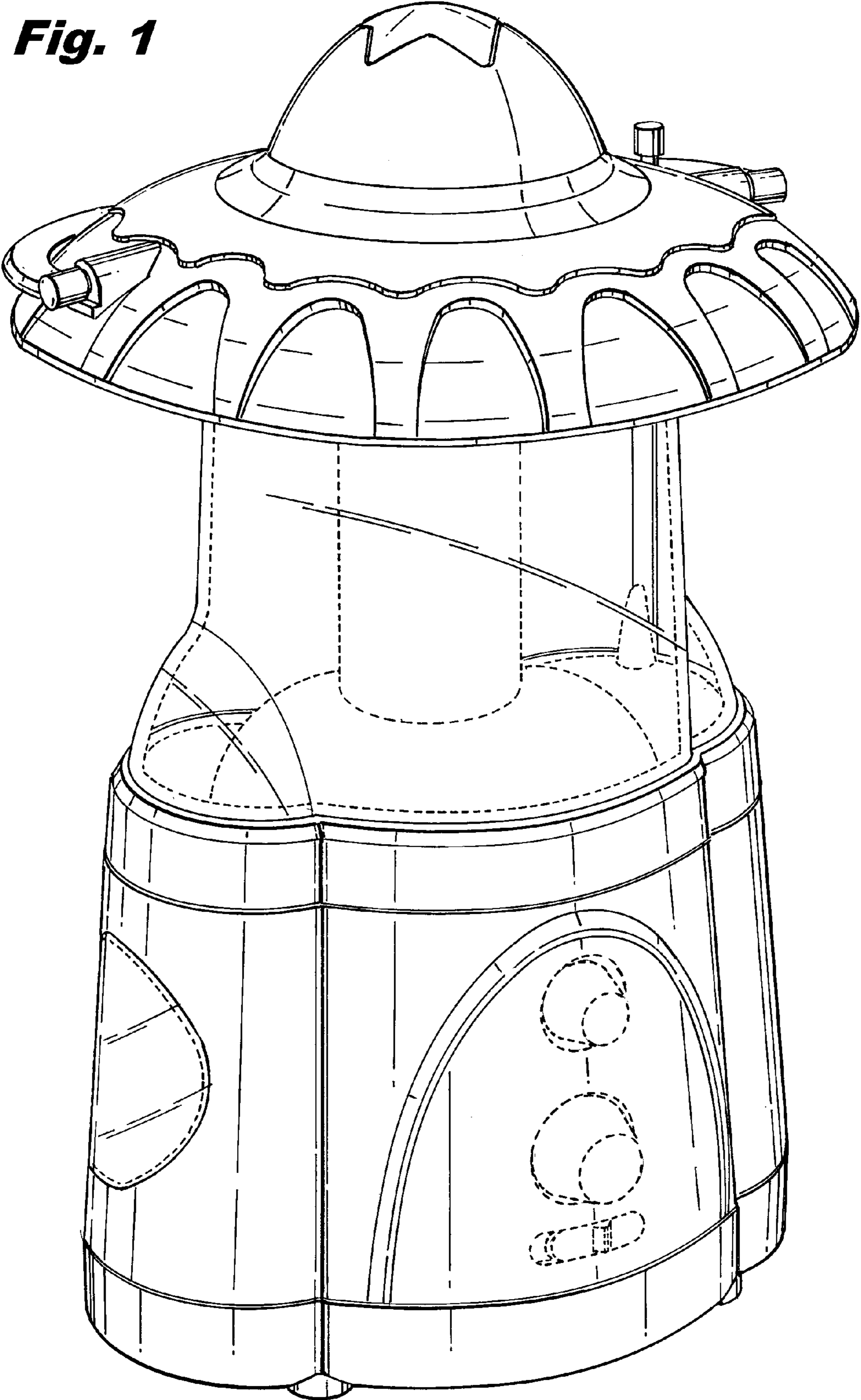

Fig. 2

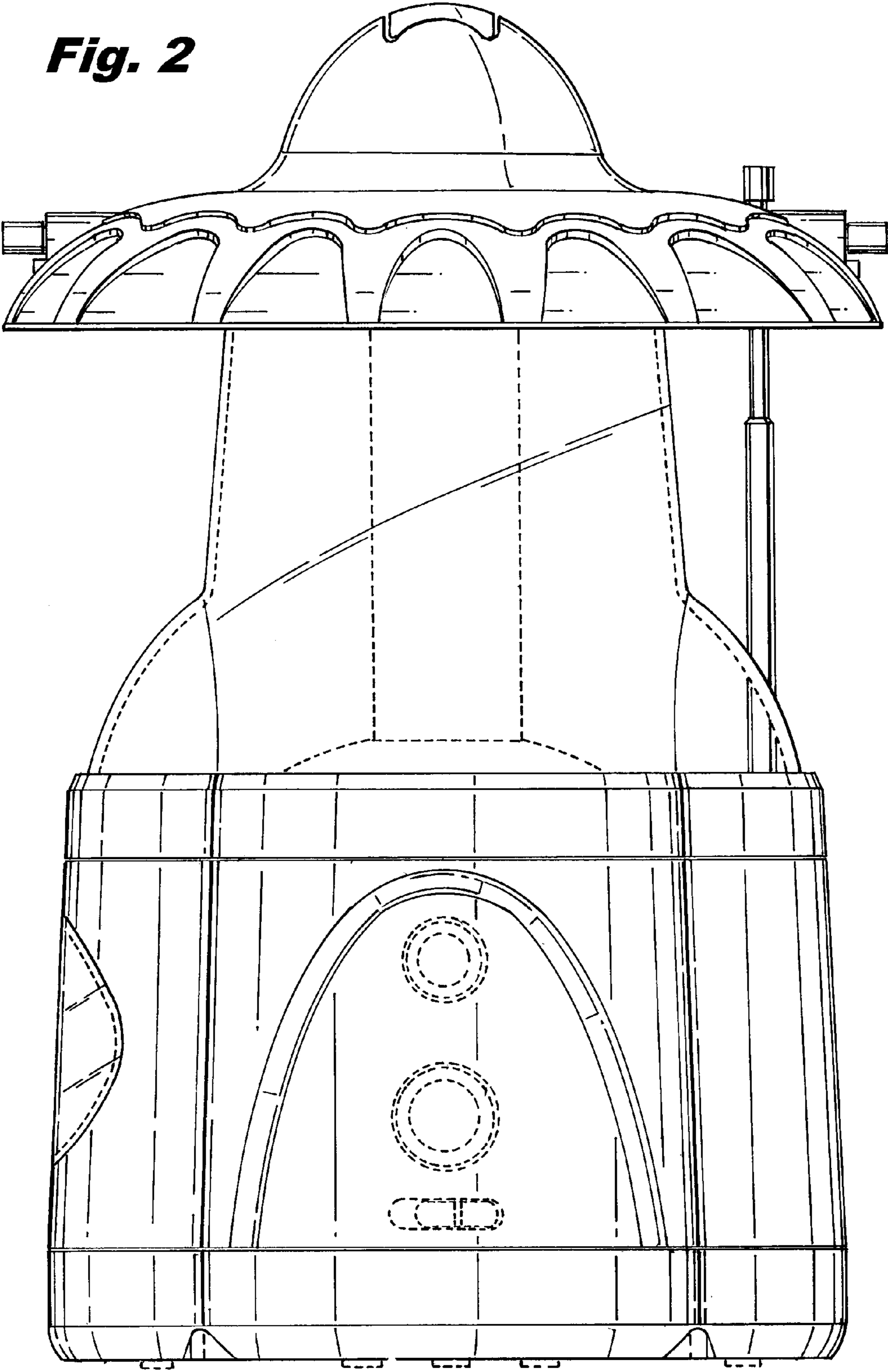

Fig. 3

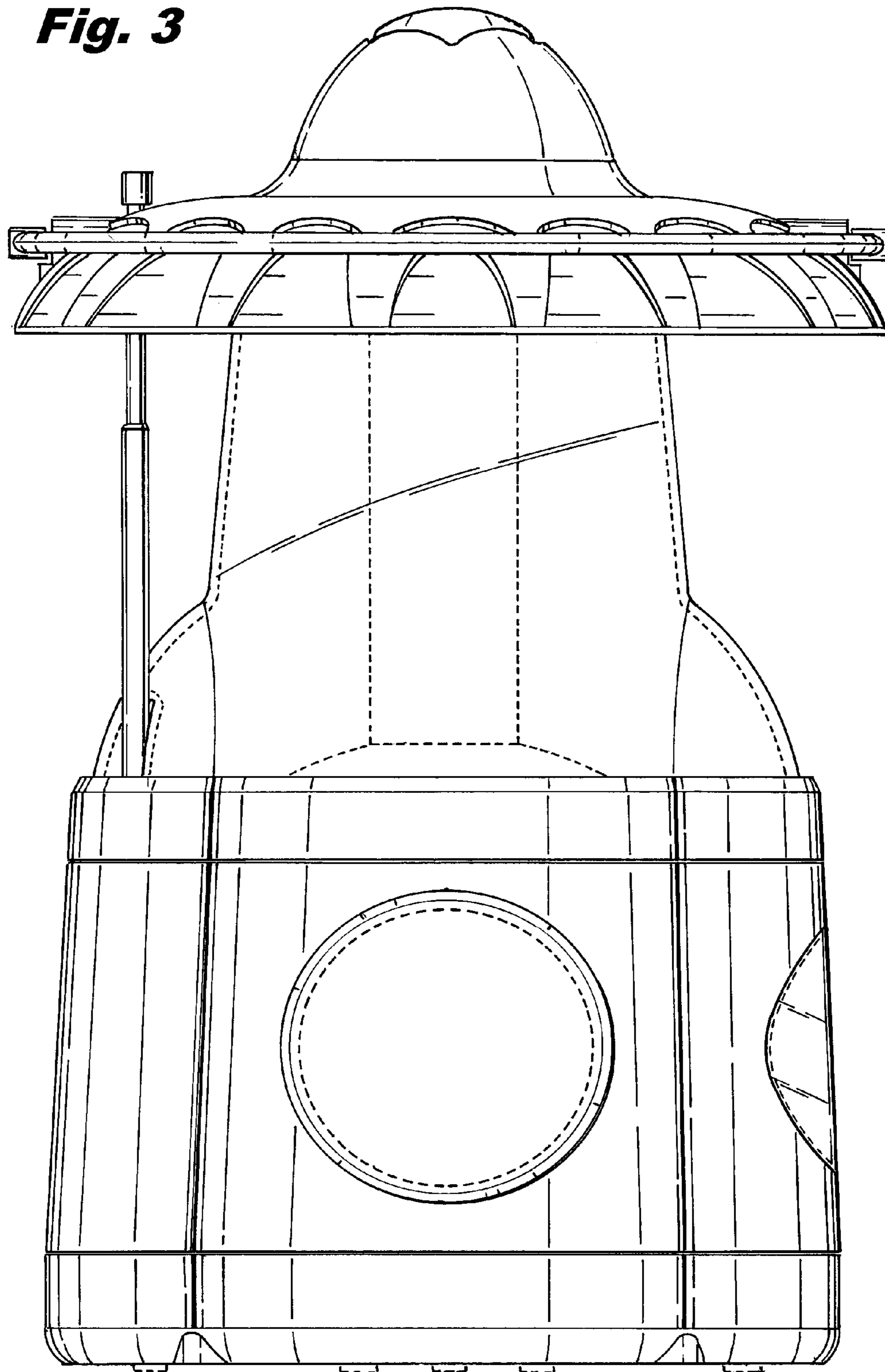

Fig. 4

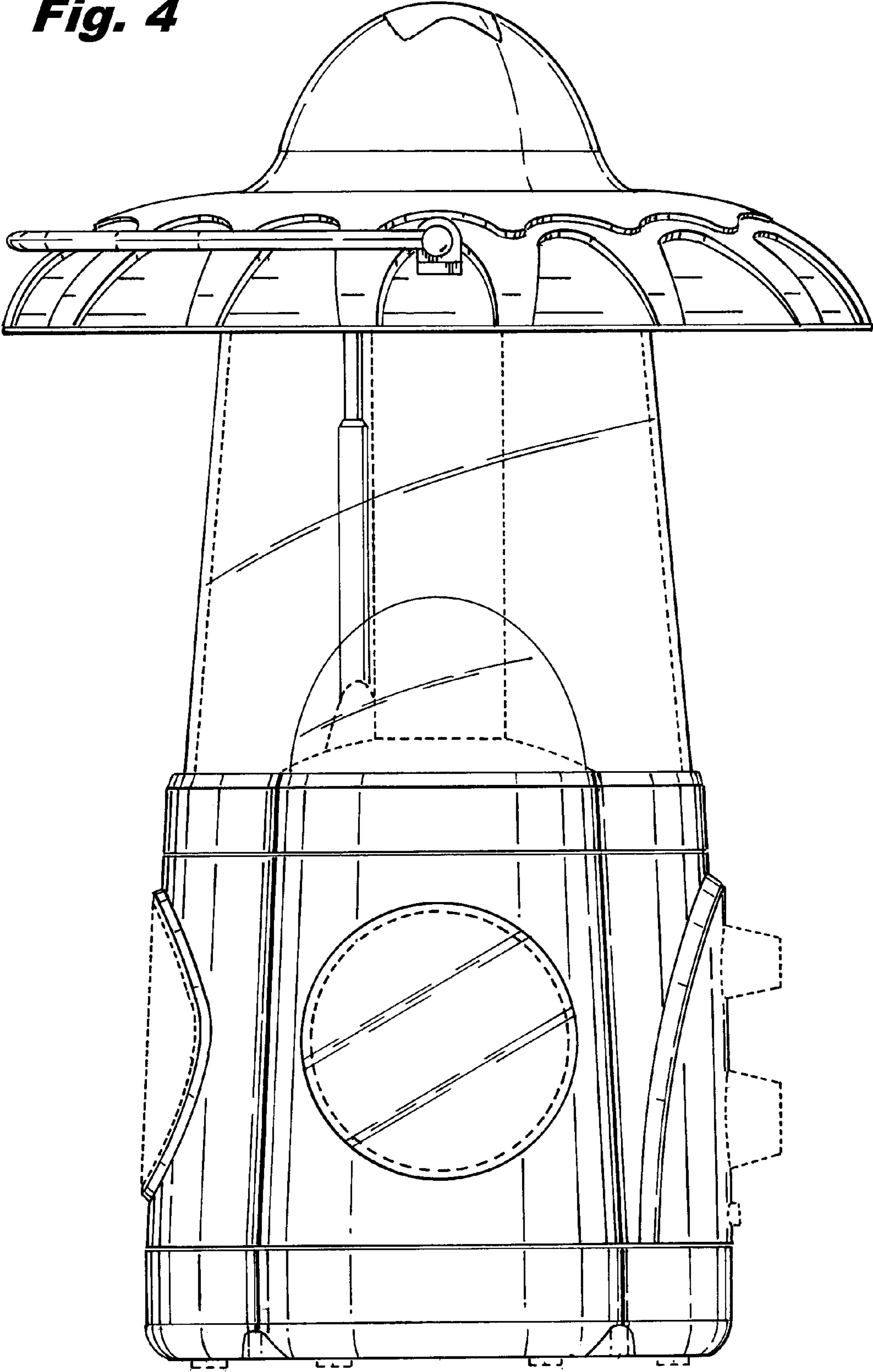
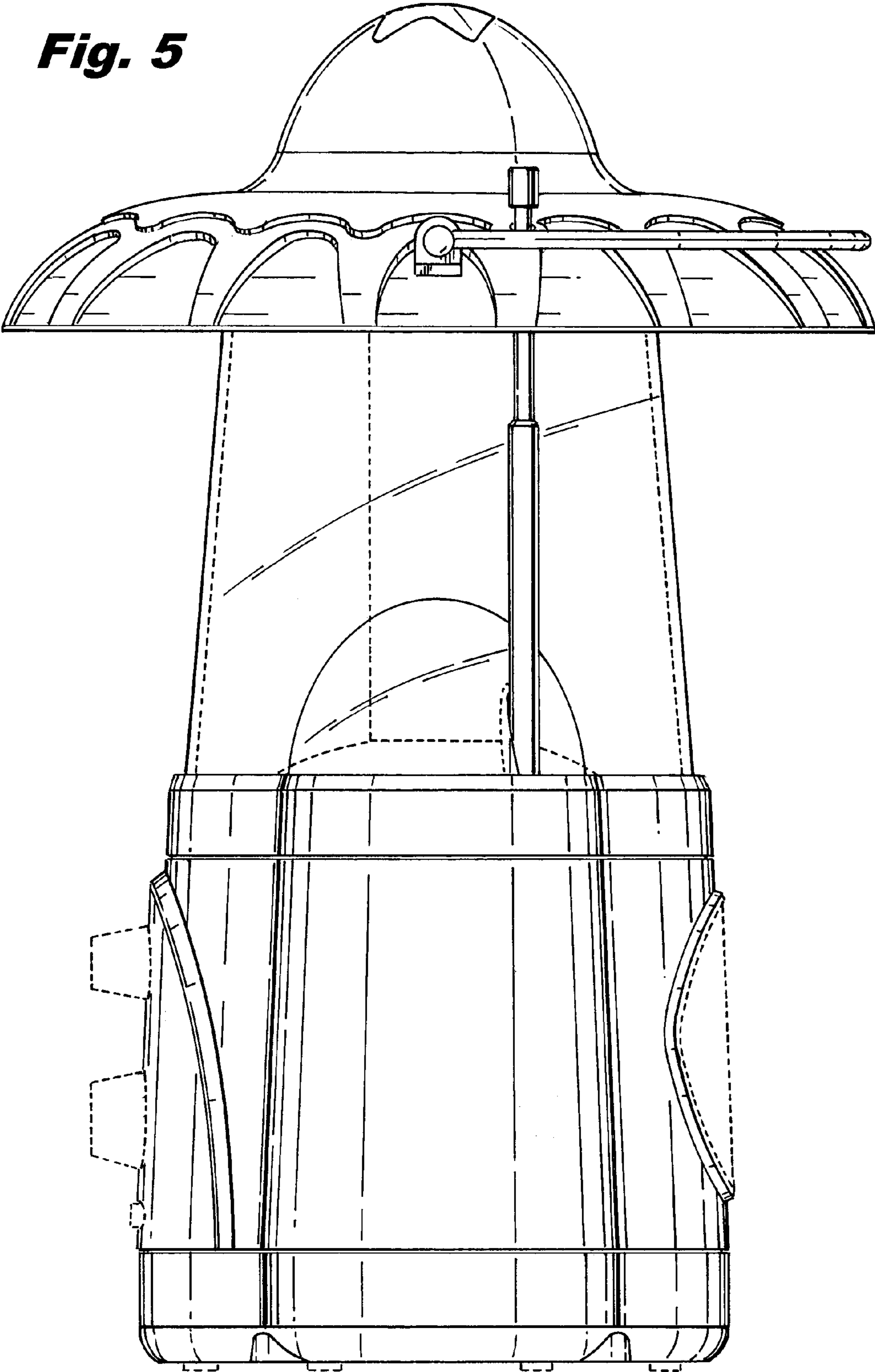

Fig. 5



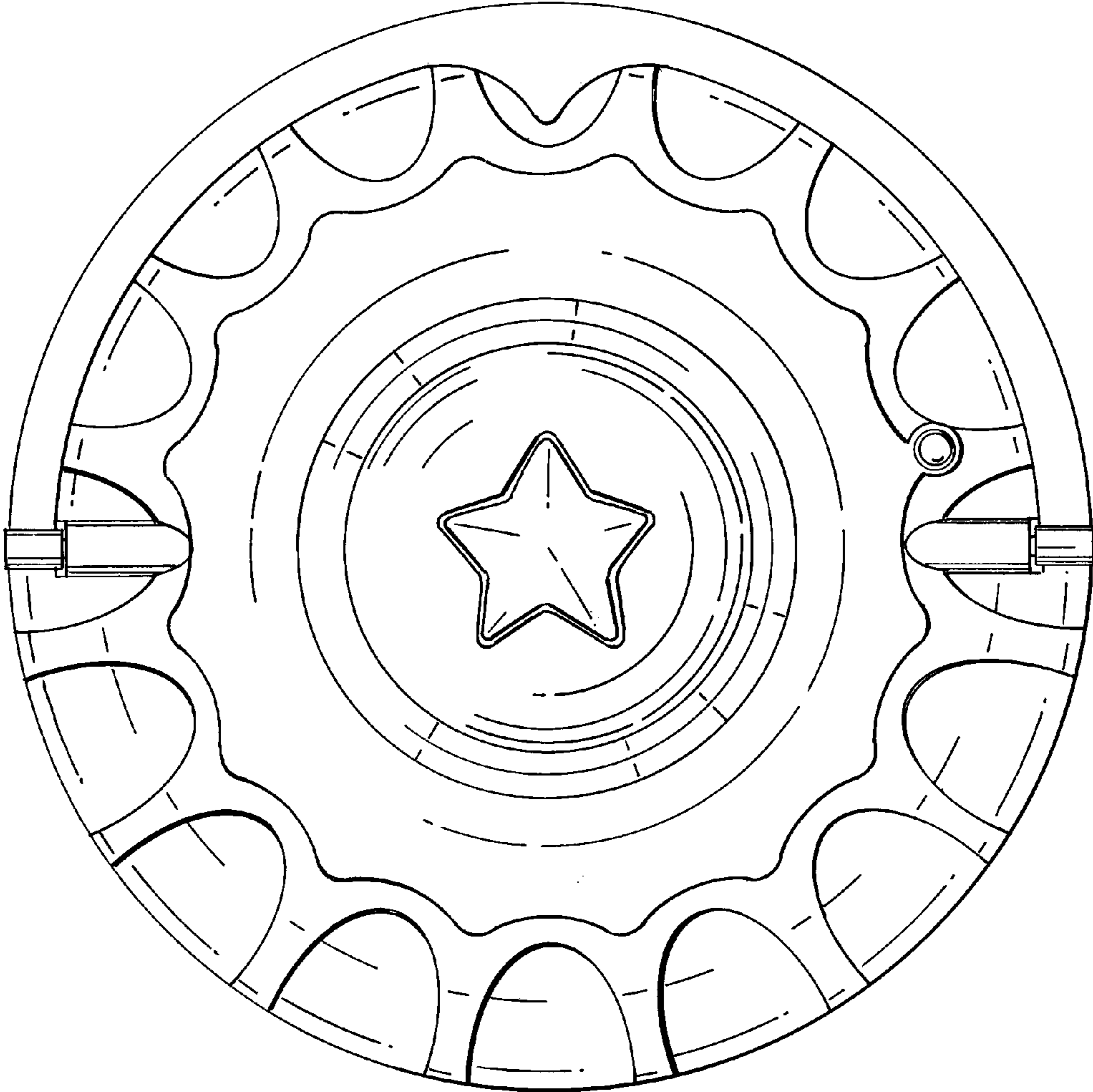

Fig. 6

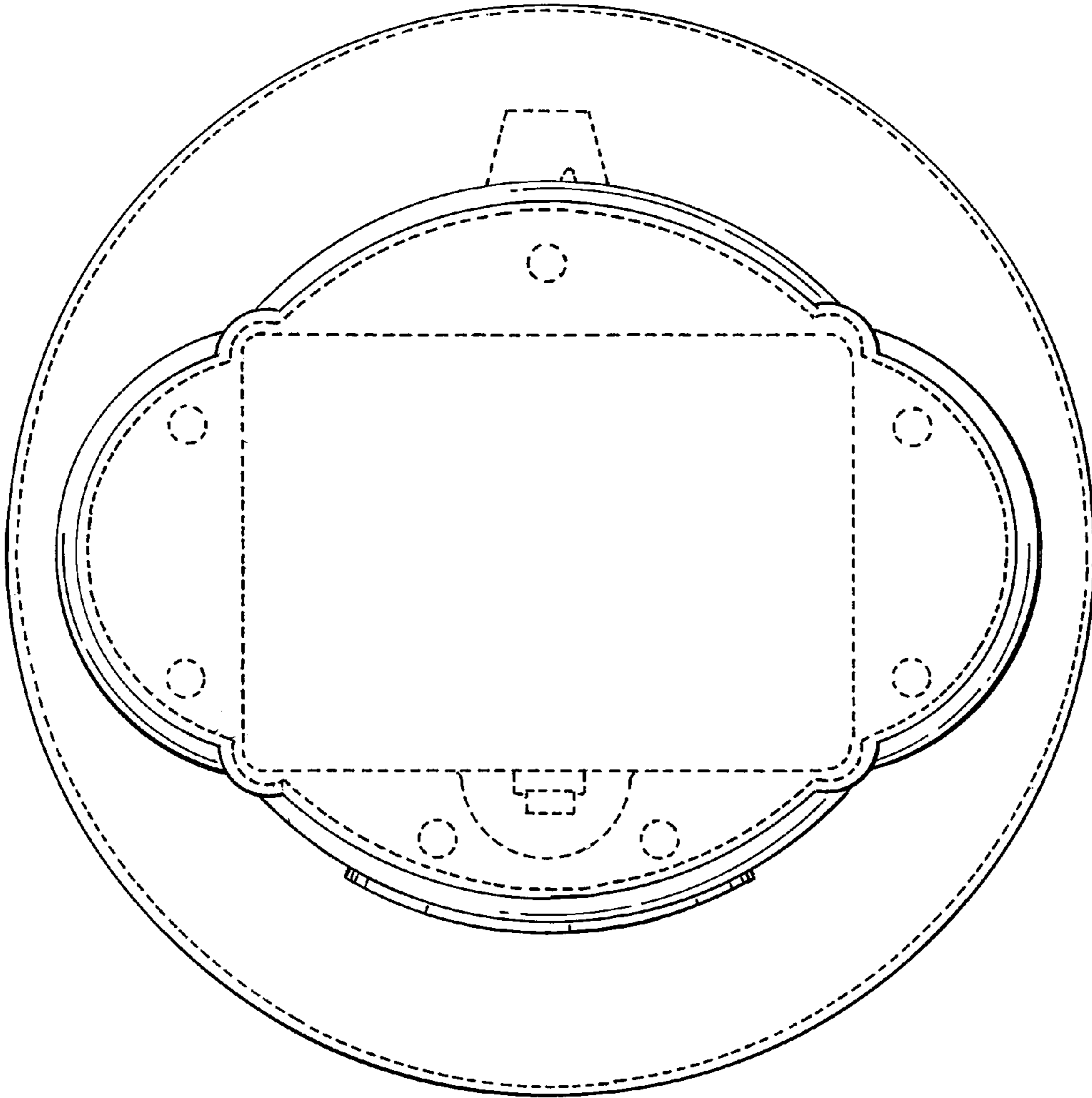

Fig. 7