



US00D722693S

(12) **United States Design Patent**
Kaufmann et al.

(10) **Patent No.:** **US D722,693 S**

(45) **Date of Patent:** **** Feb. 17, 2015**

(54) **CERVICAL IMPLANT**

(75) Inventors: **Josh Kaufmann**, Austin, TX (US); **Greg Calbert**, Austin, TX (US); **Scott Bryant**, Austin, TX (US)

(73) Assignee: **Genesys Spine**, Austin, TX (US)

(**) Term: **14 Years**

(21) Appl. No.: **29/417,125**

(22) Filed: **Mar. 30, 2012**

(51) **LOC (10) Cl.** **24-02**

(52) **U.S. Cl.**
USPC **D24/155**

(58) **Field of Classification Search**
USPC D24/155, 156, 133, 152, 154, 135,
D24/144-146, 151; 606/194, 198, 90, 86 A;
623/23.54, 23.7, 1.15, 903, 17.11,
623/17.15, 17.16, 17.12; 604/1.02, 103.02
See application file for complete search history.

(56) **References Cited**

U.S. PATENT DOCUMENTS

D533,277 S * 12/2006 Blain D24/155
D594,986 S * 6/2009 Miles et al. D24/155
D599,019 S * 8/2009 Pimenta et al. D24/155

D616,546 S * 5/2010 Vraney et al. D24/155
D620,110 S * 7/2010 Courtney et al. D24/155
D620,113 S * 7/2010 Courtney et al. D24/155
D620,116 S * 7/2010 Pannu D24/155
D621,509 S * 8/2010 Lovell D24/155
D625,820 S * 10/2010 Calverley et al. D24/155
D627,467 S * 11/2010 Pannu D24/155
D627,468 S * 11/2010 Richter et al. D24/155
D629,108 S * 12/2010 Richter et al. D24/155
D650,481 S * 12/2011 Gottlieb et al. D24/155

* cited by examiner

Primary Examiner — Ian Simmons

Assistant Examiner — Charles Hanson

(74) *Attorney, Agent, or Firm* — Trop, Pruner & Hu, P.C.

(57) **CLAIM**

The ornamental design for cervical implant, as shown and described.

DESCRIPTION

FIG. 1 is a perspective view of cervical implant;
FIG. 2 is a front plan view thereof;
FIG. 3 is a rear plan view thereof;
FIG. 4 is a left side plan view thereof;
FIG. 5 is a right side plan view thereof;
FIG. 6 is a top plan view thereof; and,
FIG. 7 is a bottom plan view thereof.
The dotted lines in the figures illustrate environment and do not form any part of the claimed design.

1 Claim, 4 Drawing Sheets

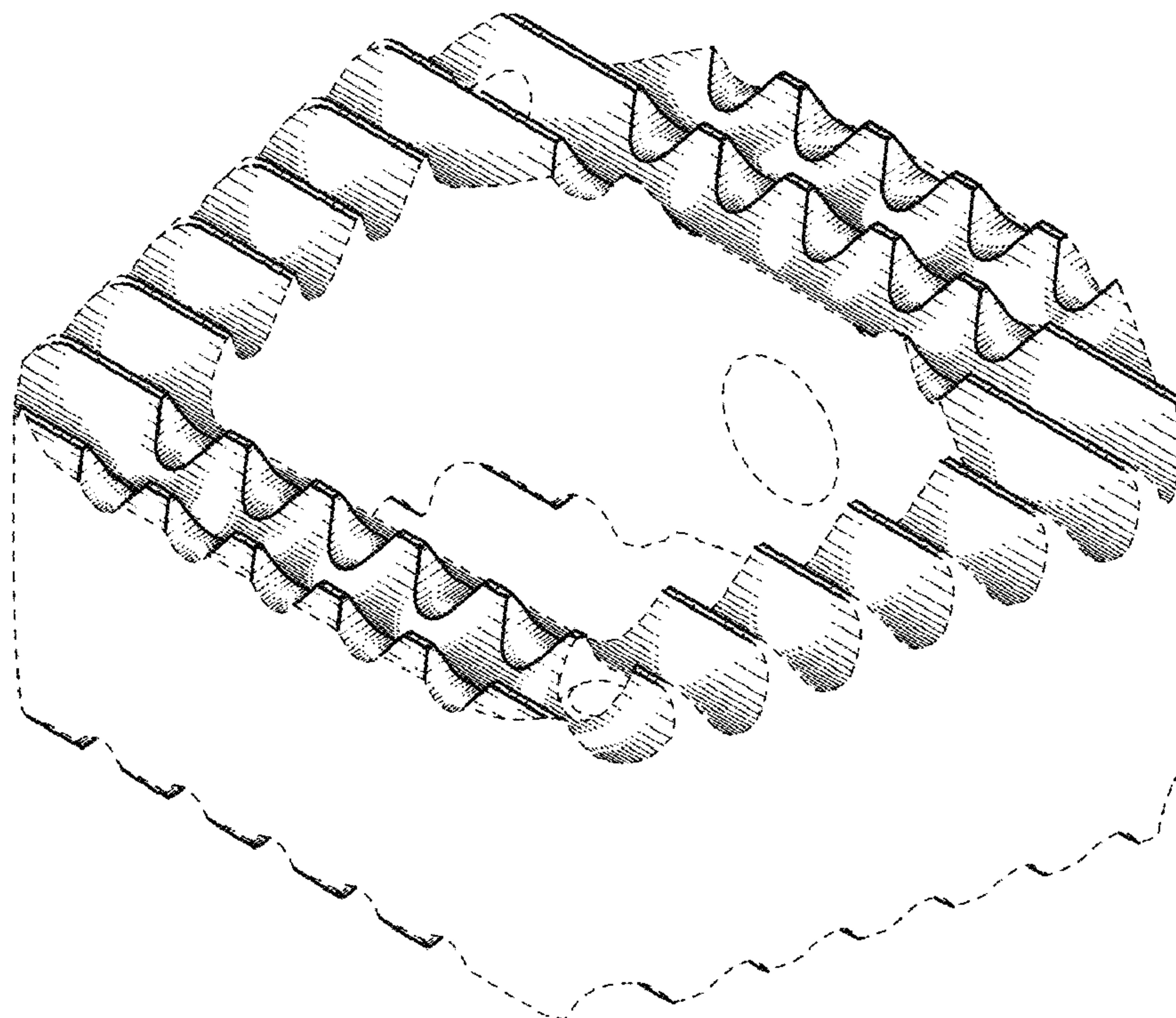

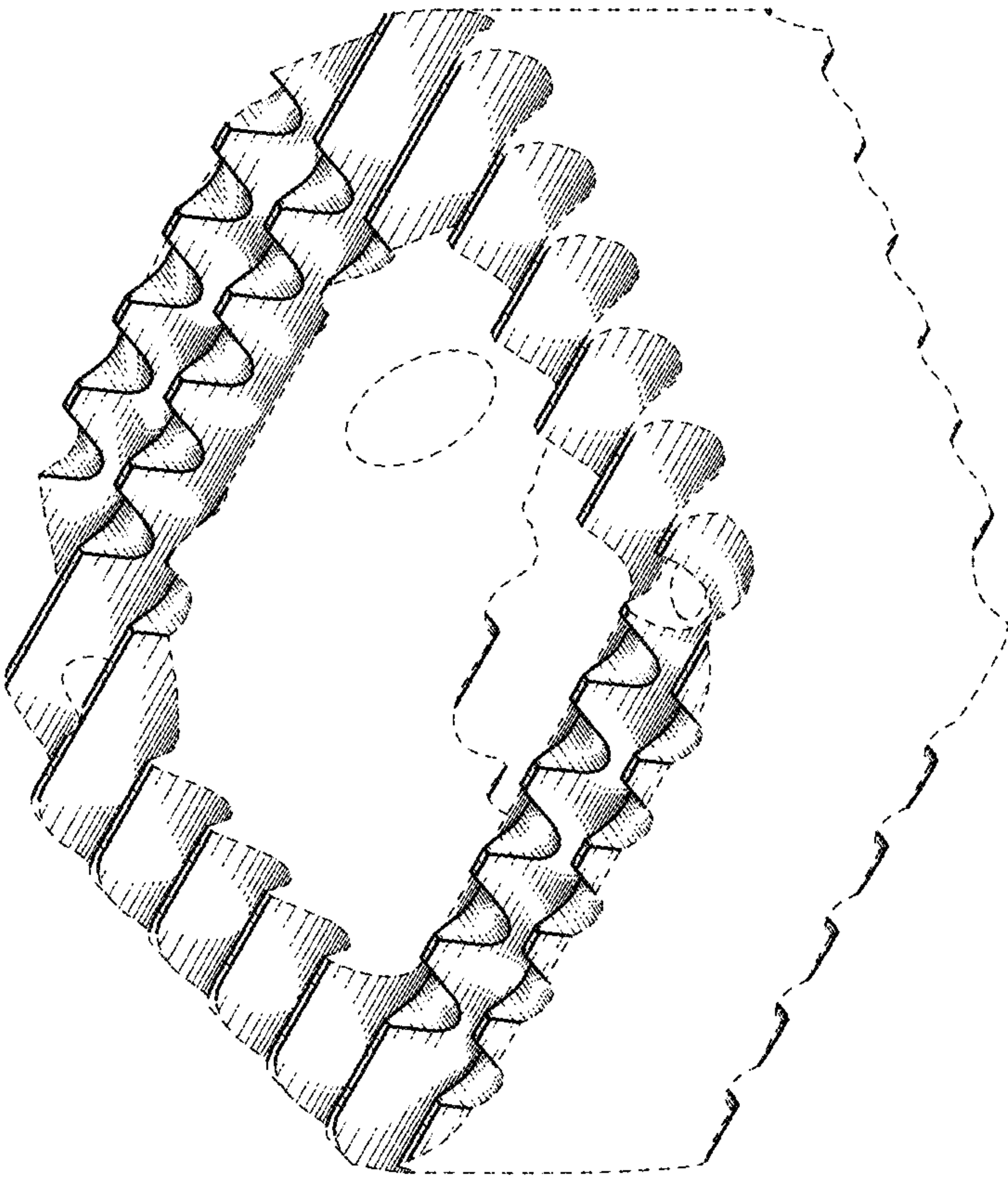

FIG. 1

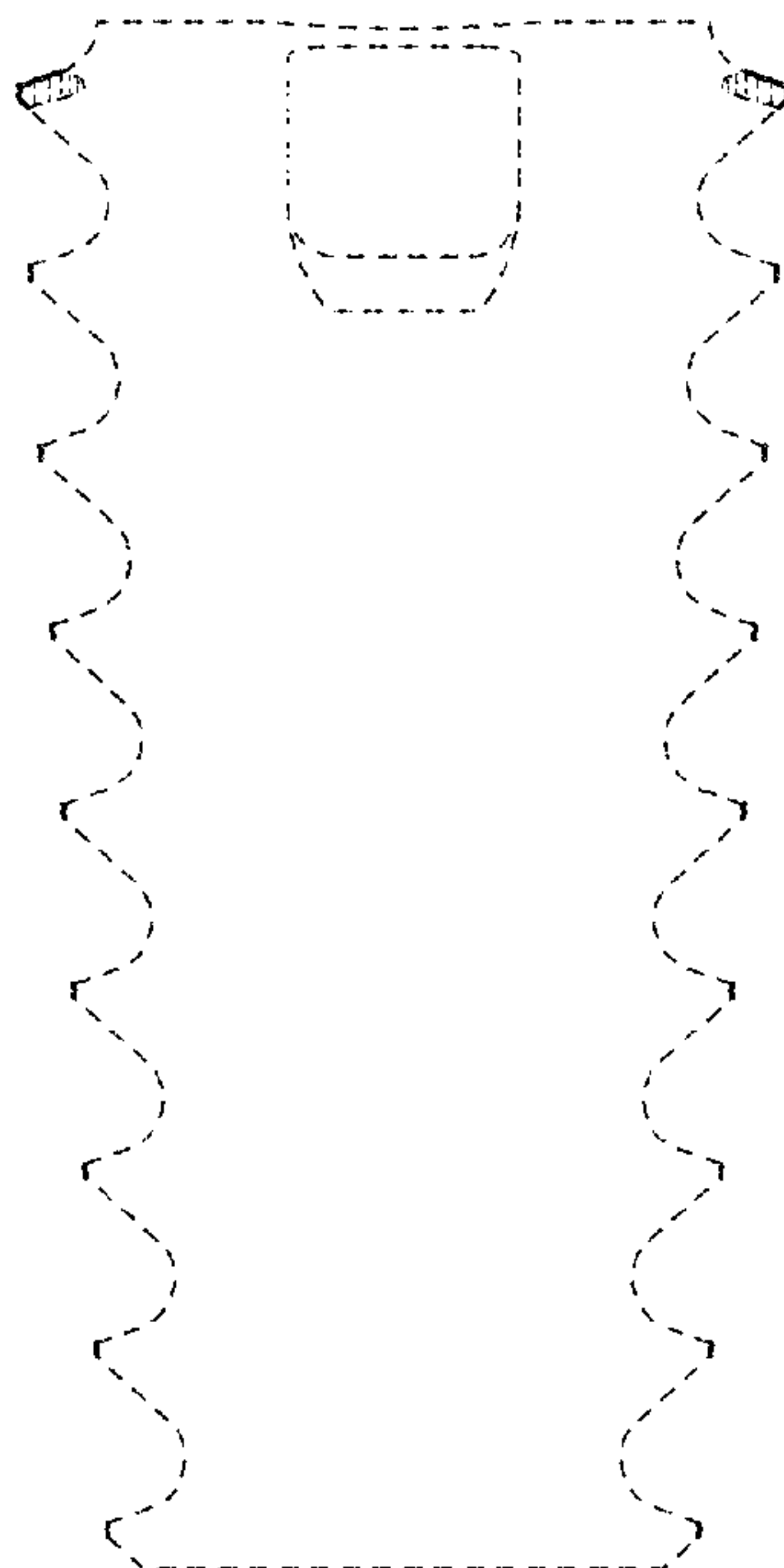

FIG. 3

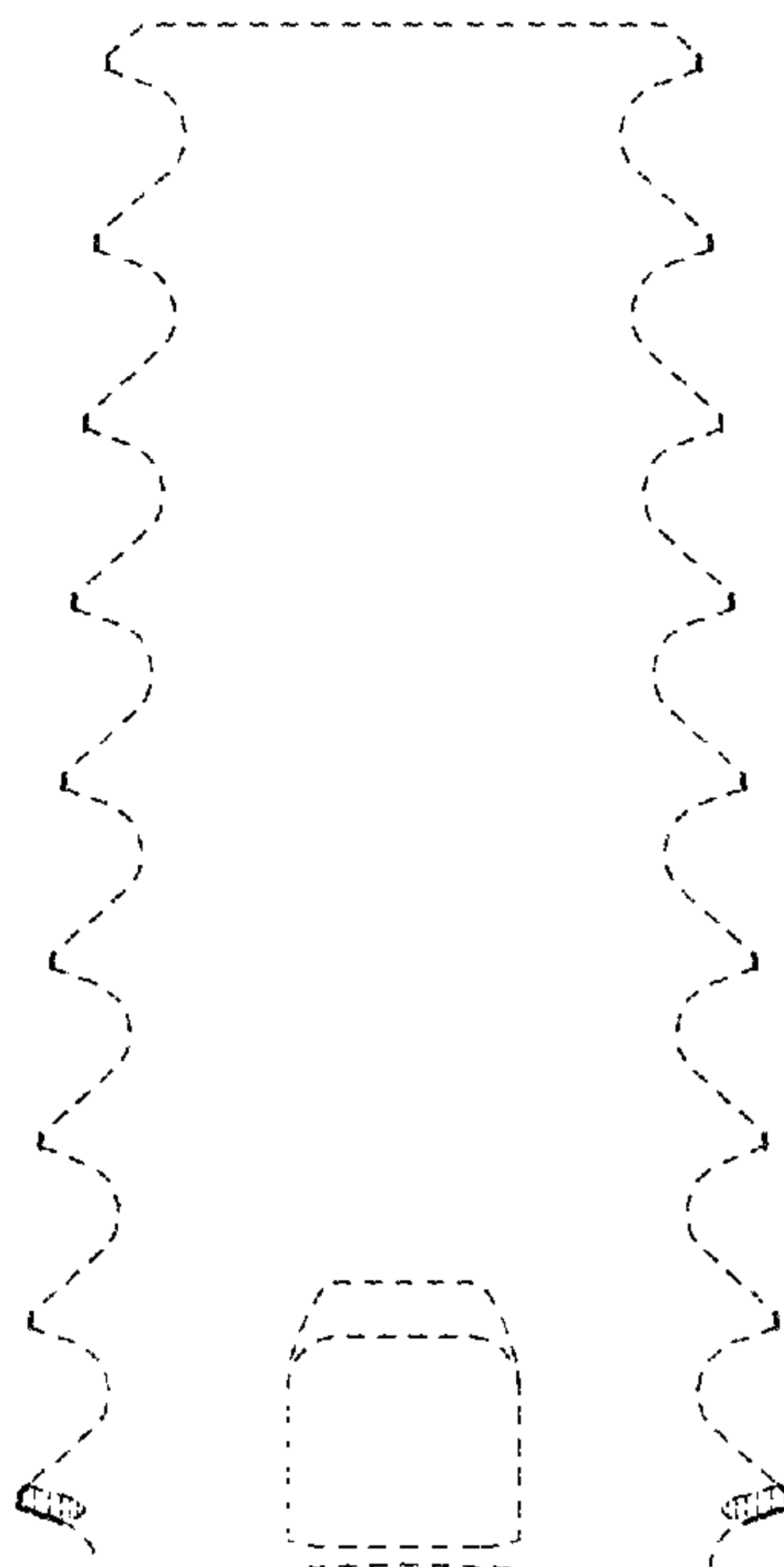

FIG. 2

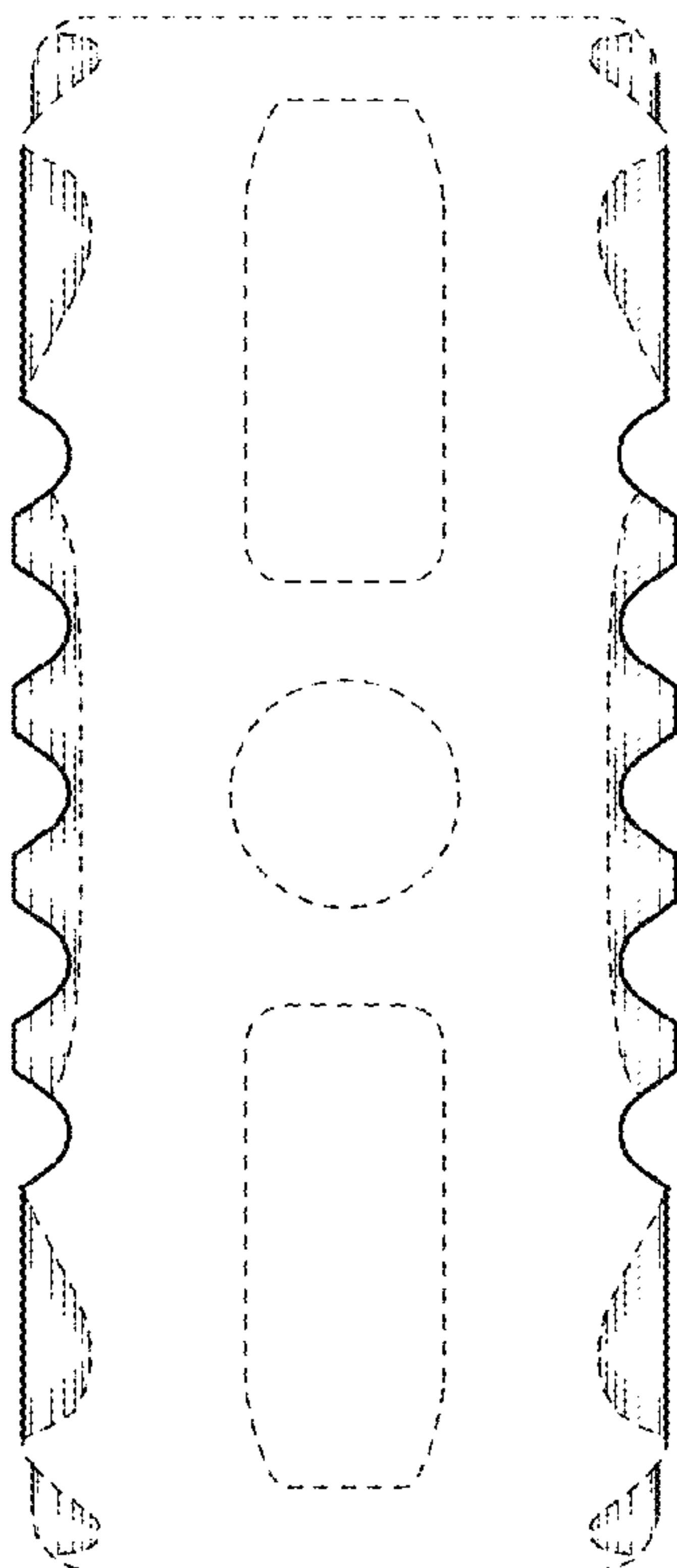

FIG. 5

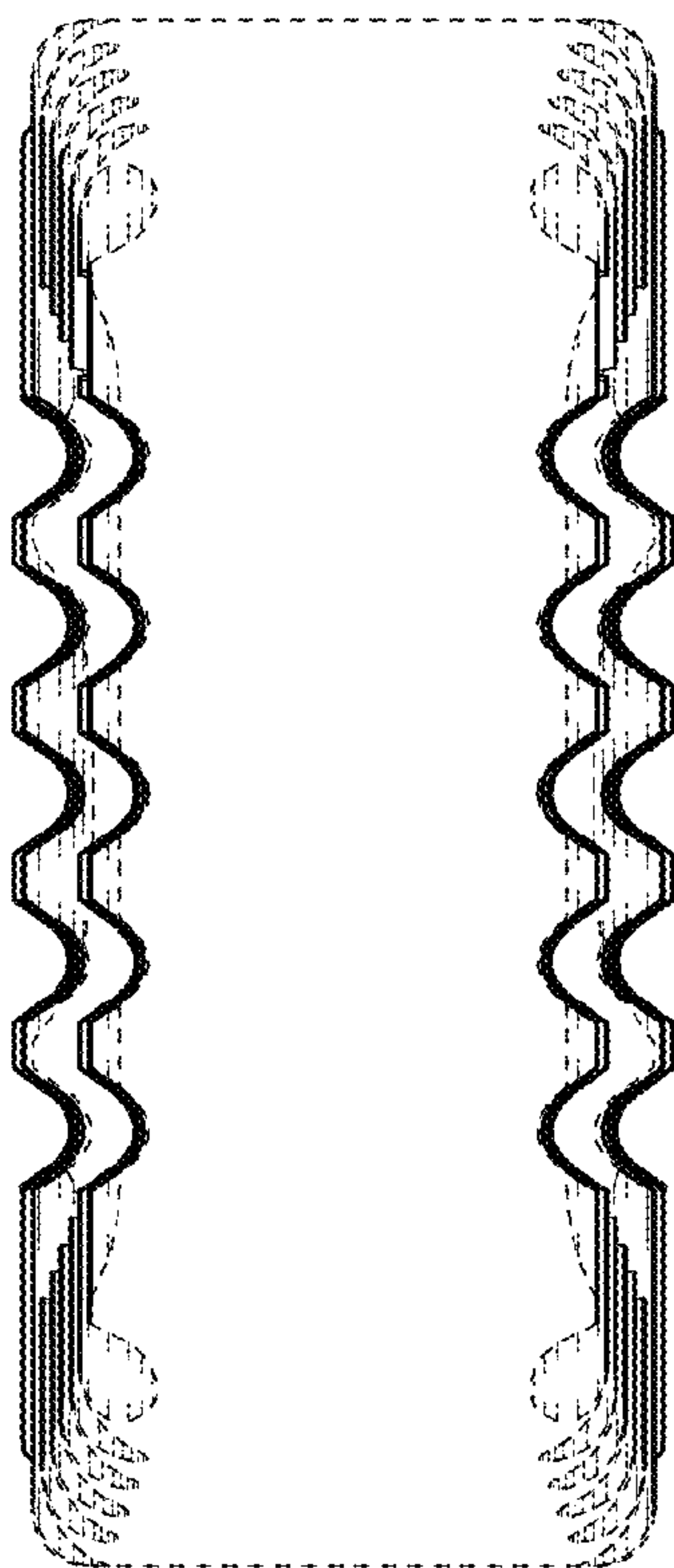

FIG. 4

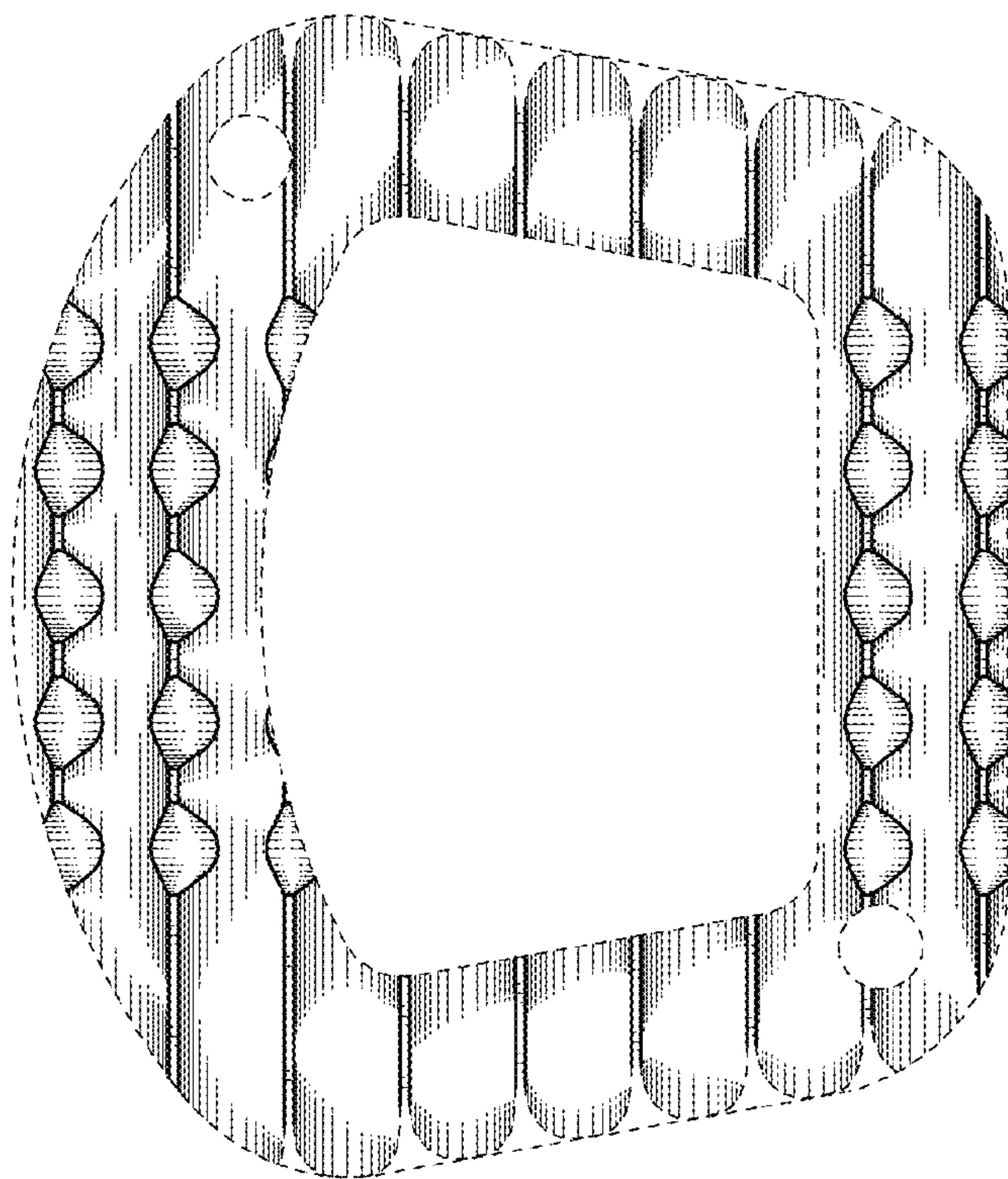

FIG. 7

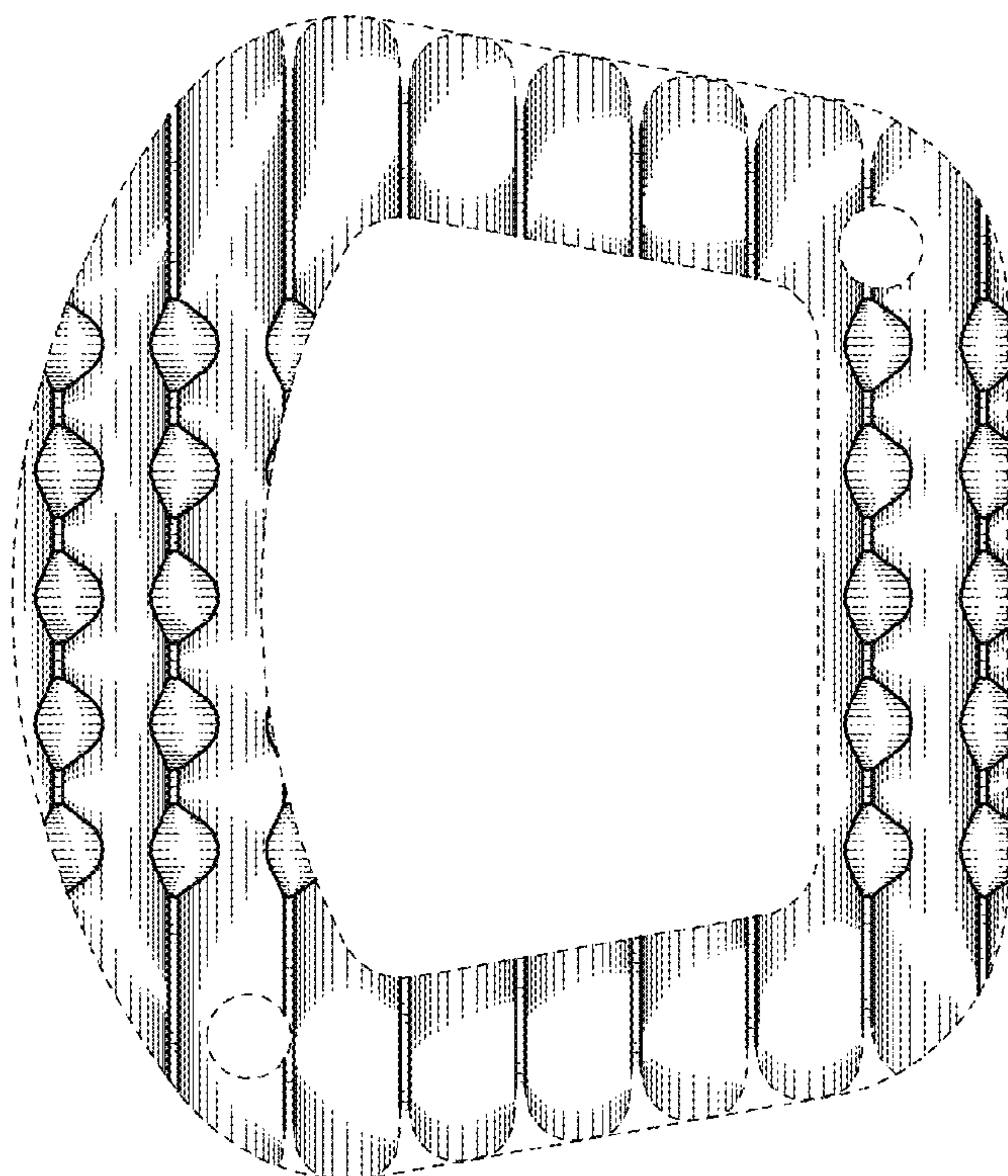

FIG. 6