



US00D722580S

(12) **United States Design Patent**  
**Dhondt**

(10) **Patent No.:** **US D722,580 S**  
(45) **Date of Patent:** **\*\* \*Feb. 17, 2015**

(54) **HANDSET**

FOREIGN PATENT DOCUMENTS

(71) Applicant: **Nokia Corporation**, Espoo (FI)

AU 335414 10/2011  
CN 301617446 \* 7/2011

(72) Inventor: **Daniel Dhondt**, Espoo (FI)

(Continued)

(73) Assignee: **Nokia Corporation**, Espoo (FI)

OTHER PUBLICATIONS

(\* ) Notice: This patent is subject to a terminal disclaimer.

LG Optimus Black (White version), announced Jul. 2011, [online], [retrieved on Aug. 19, 2011]. Retrieved from Internet, <URL: http://www.gsmarena.com>.\*

(Continued)

(\*\*) Term: **14 Years**

*Primary Examiner* — Bridget L Eland

(21) Appl. No.: **29/438,525**

(74) *Attorney, Agent, or Firm* — Banner & Witcoff, Ltd.

(22) Filed: **Nov. 30, 2012**

(57)

**CLAIM**

The ornamental design for a handset, as shown and described.

(51) **LOC (10) Cl.** ..... **14-03**

**DESCRIPTION**

(52) **U.S. Cl.**  
USPC ..... **D14/138 G**

(58) **Field of Classification Search**  
USPC ..... D14/138 R, 138 AD, 138 AC, 138 C,  
D14/138 G, 137, 341–347, 247–248;  
455/566, 575.1, 575.3, 575.4  
See application file for complete search history.

FIG. 1 is a perspective view of a handset showing my new design;  
FIG. 2 is a front view thereof;  
FIG. 3 is a rear view thereof;  
FIG. 4 is a left side view thereof;  
FIG. 5 is a right side view thereof;  
FIG. 6 is a top view thereof;  
FIG. 7 is a bottom view thereof;  
FIG. 8 is a perspective view of a handset showing my new design;  
FIG. 9 is a front view thereof;  
FIG. 10 is a rear view thereof;  
FIG. 11 is a left side view thereof;  
FIG. 12 is a right side view thereof;  
FIG. 13 is a top view thereof; and,  
FIG. 14 is a bottom view thereof.

(56) **References Cited**

U.S. PATENT DOCUMENTS

D555,131 S \* 11/2007 Kim et al. .... D14/138 AD  
D570,816 S \* 6/2008 Lee et al. .... D14/138 AD  
D578,987 S 10/2008 Lee et al.  
D579,433 S 10/2008 Han et al.  
D592,168 S 5/2009 Bai et al.  
D593,132 S 5/2009 Kim  
D593,525 S 6/2009 Wang  
D599,342 S 9/2009 Andre et al.  
D602,014 S \* 10/2009 Andre et al. .... D14/341  
D602,486 S \* 10/2009 Andre et al. .... D14/341  
D606,038 S 12/2009 Aarras

The broken lines shown in FIGS. 1-14, that are immediately adjacent to the shaded areas, and define unshaded regions, represent the bounds of the first and second embodiments, while all other broken lines are directed to environment and are for illustrative purposes only; the broken lines form no part of the first or second embodiment.

(Continued)

**1 Claim, 10 Drawing Sheets**

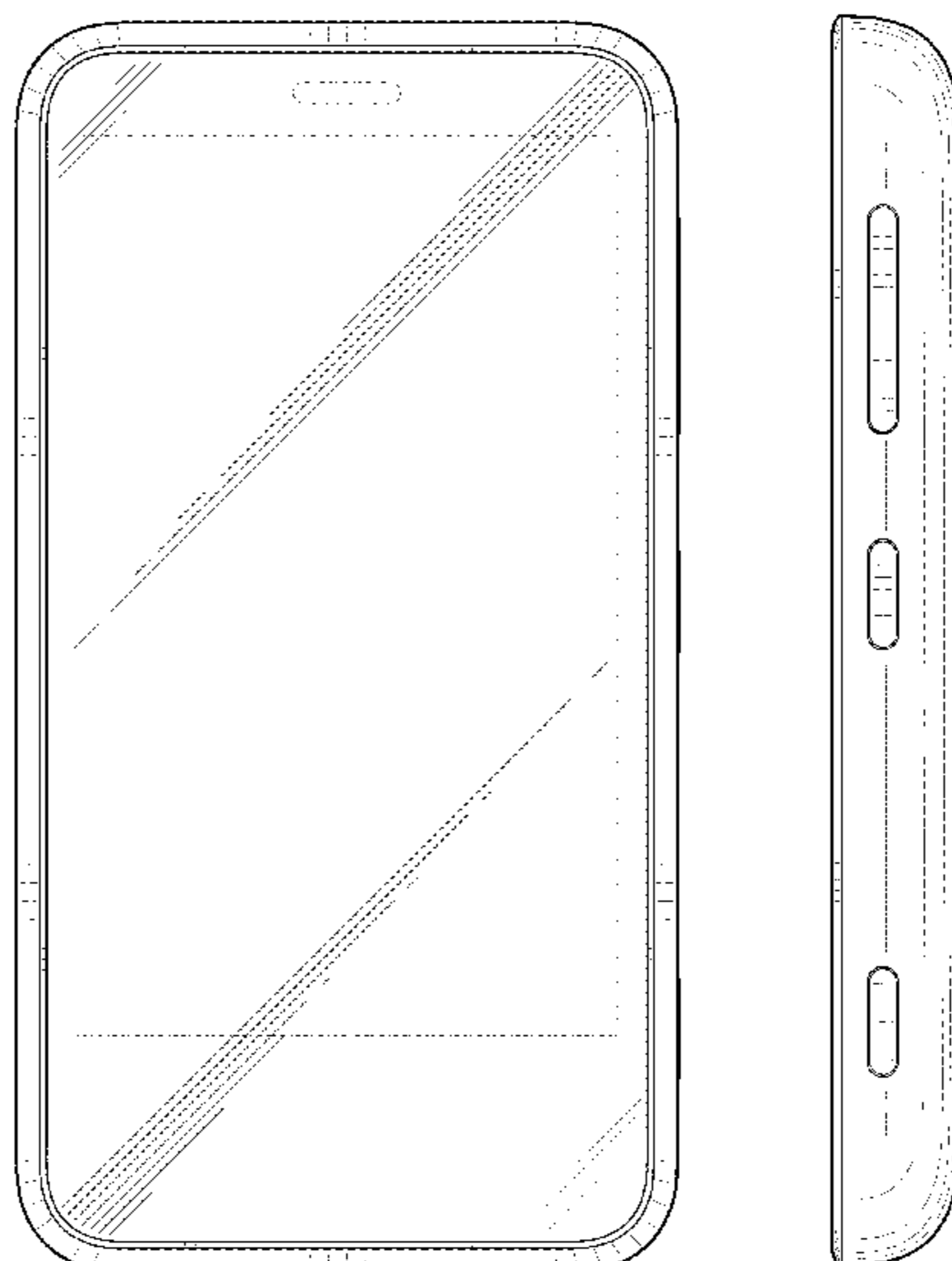

(56)

References Cited

U.S. PATENT DOCUMENTS

D606,961	S	12/2009	Aarras	
D609,680	S *	2/2010	Kim et al. ....	D14/138 AD
D616,852	S *	6/2010	Kim et al. ....	D14/138 AD
D617,792	S	6/2010	Andre et al.	
D618,655	S	6/2010	Sandberg	
D618,678	S	6/2010	Andre et al.	
D619,555	S *	7/2010	Yang et al. ....	D14/138 G
D620,004	S	7/2010	Andre et al.	
D623,624	S *	9/2010	Joung et al. ....	D14/138 AD
D626,937	S *	11/2010	Yeo et al. ....	D14/203.7
D627,779	S	11/2010	Liao	
D629,784	S	12/2010	Forsyth	
D633,888	S	3/2011	Eguchi	
D634,318	S	3/2011	Buckle et al.	
D635,537	S *	4/2011	Kim .....	D14/138 G
D635,954	S	4/2011	Aarras	
D635,967	S	4/2011	Montin et al.	
D636,364	S	4/2011	Sandberg	
D637,992	S	5/2011	Tom et al.	
D638,814	S	5/2011	Sutherland et al.	
D648,693	S *	11/2011	Kim et al. ....	D14/138 AD
D650,350	S	12/2011	Wong	
D651,998	S	1/2012	Marsh	
D652,000	S	1/2012	Liu	
D652,403	S	1/2012	Fahlgren et al.	
D654,900	S *	2/2012	Jung .....	D14/138 G
D657,764	S	4/2012	Hong	
D658,620	S	5/2012	Lylyk	
D660,274	S *	5/2012	Lee .....	D14/138 G
D660,278	S *	5/2012	Bang .....	D14/138 G
D662,486	S	6/2012	Faoro	
D662,489	S *	6/2012	Yeo .....	D14/203.7
D665,761	S	8/2012	Russo	
D665,764	S	8/2012	Shi et al.	
D669,053	S	10/2012	Forsyth	
D669,446	S *	10/2012	Cho .....	D14/138 G
D672,327	S *	12/2012	Lee .....	D14/138 AD
D674,369	S *	1/2013	JaeWoong .....	D14/138 G
D676,399	S *	2/2013	Cho .....	D14/138 G
D676,459	S *	2/2013	Hofer et al. ....	D14/496
D677,640	S *	3/2013	Kim et al. ....	D14/138 G
D680,512	S	4/2013	Lu et al.	
D681,578	S *	5/2013	Park .....	D14/138 G
D681,594	S *	5/2013	Hong .....	D14/138 G
D686,177	S *	7/2013	Lee .....	D14/138 G
D689,840	S	9/2013	Lu	
D692,845	S	11/2013	Cho	
2009/0170573	A1 *	7/2009	Harmon et al. ....	455/575.4
2011/0151945	A1 *	6/2011	Jiang et al. ....	455/575.1

FOREIGN PATENT DOCUMENTS

EM	0735717-002	6/2007
EM	784780-001	9/2007
EM	1001846-001	9/2008
EM	1053060-001	12/2008
EM	1071849-002	1/2009
EM	1098149-007	3/2009
EM	001189922-0001	2/2010
EM	1668781-001	2/2010
EM	1695768-01	4/2010
EM	1216063-001	5/2010
EM	1222905-010	7/2010

EM	1236590-006	9/2010
EM	1761750-002	9/2010
EM	1773722-001	10/2010
EM	1775503-006	10/2010
EM	1242960-001	11/2010
EM	1793902-001	12/2010
EM	1882895-03	6/2011
EM	001310718-0001	1/2012
HK	1200261.6M002	2/2012
IN	D250200	12/2012
JP	1379538	2/2010
JP	1433131	2/2012
KR	30-0469567	11/2007
KR	30-0585061	1/2011
KR	30-0636313	3/2012
KR	30-0644324	6/2012
KR	30-0648566	6/2012
KR	30-0652748	7/2012
KR	30-0667918	11/2012
TW	D153342	5/2013

OTHER PUBLICATIONS

Samsung Galaxy S II Epic 4G Touch, announced Aug. 2011, [online], [retrieved on Sep. 14, 2011]. Retrieved from Internet, <URL: <http://www.gsmarena.com>>.\*

Office Action received in corresponding India Application No. 254175 issued on Oct. 25, 2013. 1 Page.

Nokia N9 by Nokia Corporation, 1 full page of color photograph, disclosed on or about Jun. 2011.

Nokia Lumia 800 by Nokia Corporation, 1 full page of color photograph, disclosed on or about Oct. 2011.

Nokia N8 by Nokia Corporation, 1 full page of color photograph, disclosed on or about Apr. 2011.

Nokia 700 by Nokia Corporation, 1 full page of color photograph, disclosed on or about Aug. 2011.

Nokia C5-03 by Nokia Corporation, 1 full page of color photograph, disclosed on or about Oct. 2010.

Nokia 500 by Nokia Corporation, 1 full page of color photograph, disclosed on or about Aug. 2011.

Nokia E7 by Nokia Corporation, 1 full page of color photograph, disclosed on or about Sep. 2010.

Nokia N900 by Nokia Corporation, 1 full page of color photograph, disclosed on or about Aug. 2009.

Nokia C6-01 by Nokia Corporation, 1 full page of color photograph, disclosed on or about Sep. 2010.

Nokia X6 by Nokia Corporation, 1 full page of color photograph, disclosed on or about Sep. 2009.

Nokia 603 by Nokia Corporation, 1 full page of color photograph, disclosed on or about Oct. 2011.

Nokia C5-06 by Nokia Corporation, 1 full page of color photograph, disclosed on or about Oct. 2011.

Nokia 5530 Xpress Music by Nokia Corporation, 1 full page of color photograph, disclosed on or about Jun. 2009.

Nokia 5250 by Nokia Corporation, 1 full page of color photograph, disclosed on or about Aug. 2010.

Office Action received in corresponding Russian Application No. 2013502175 issued on Mar. 13, 2014. 7 pages.

Office Action received in corresponding Taiwanese Application No. 102303832 dated Feb. 24, 2014. 6 pages.

Search Report from Chilean Patent Office dated Aug. 14, 2014 corresponding to Chile No. 2013-01550, (pp. 8).

\* cited by examiner



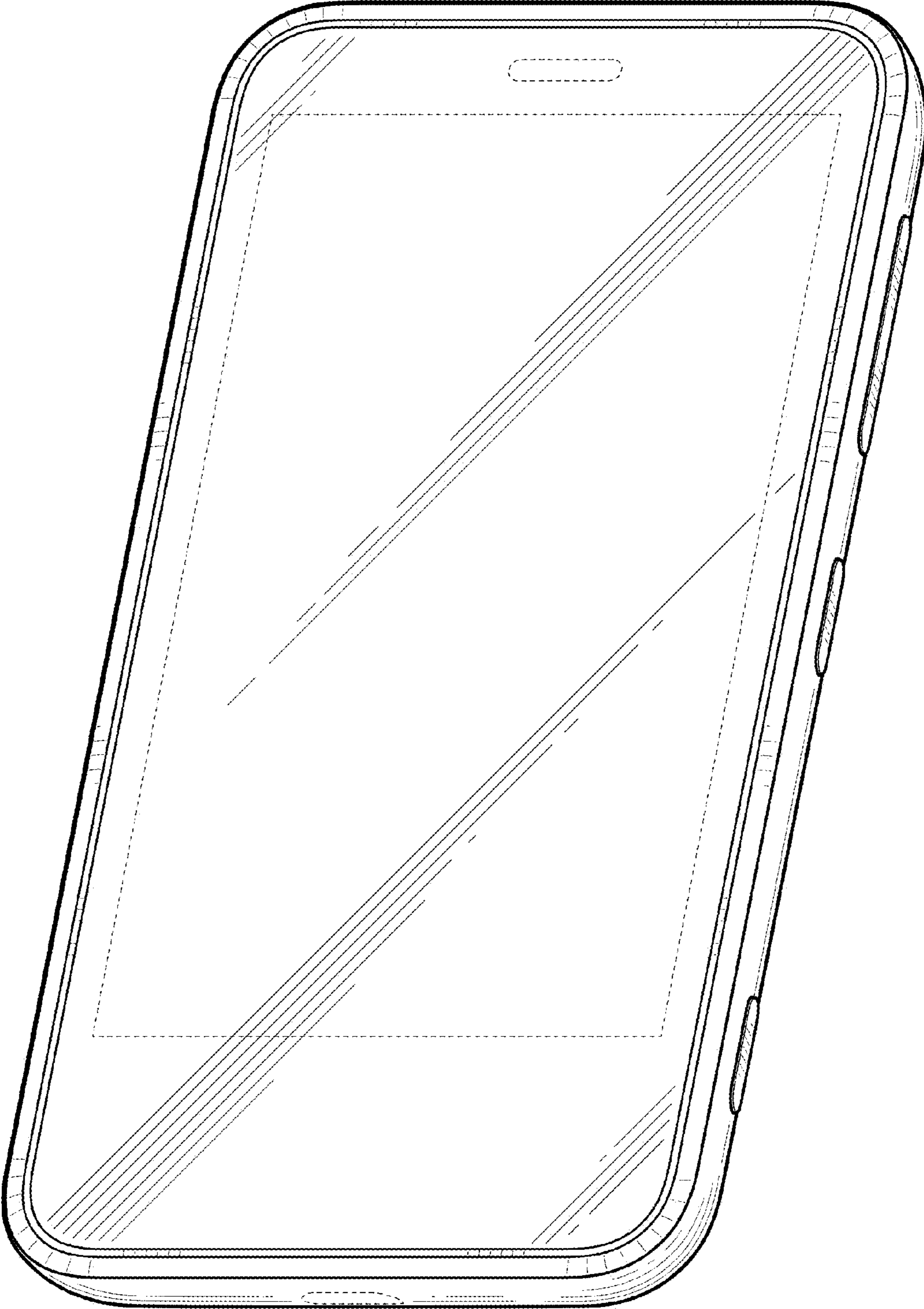

FIG. 1

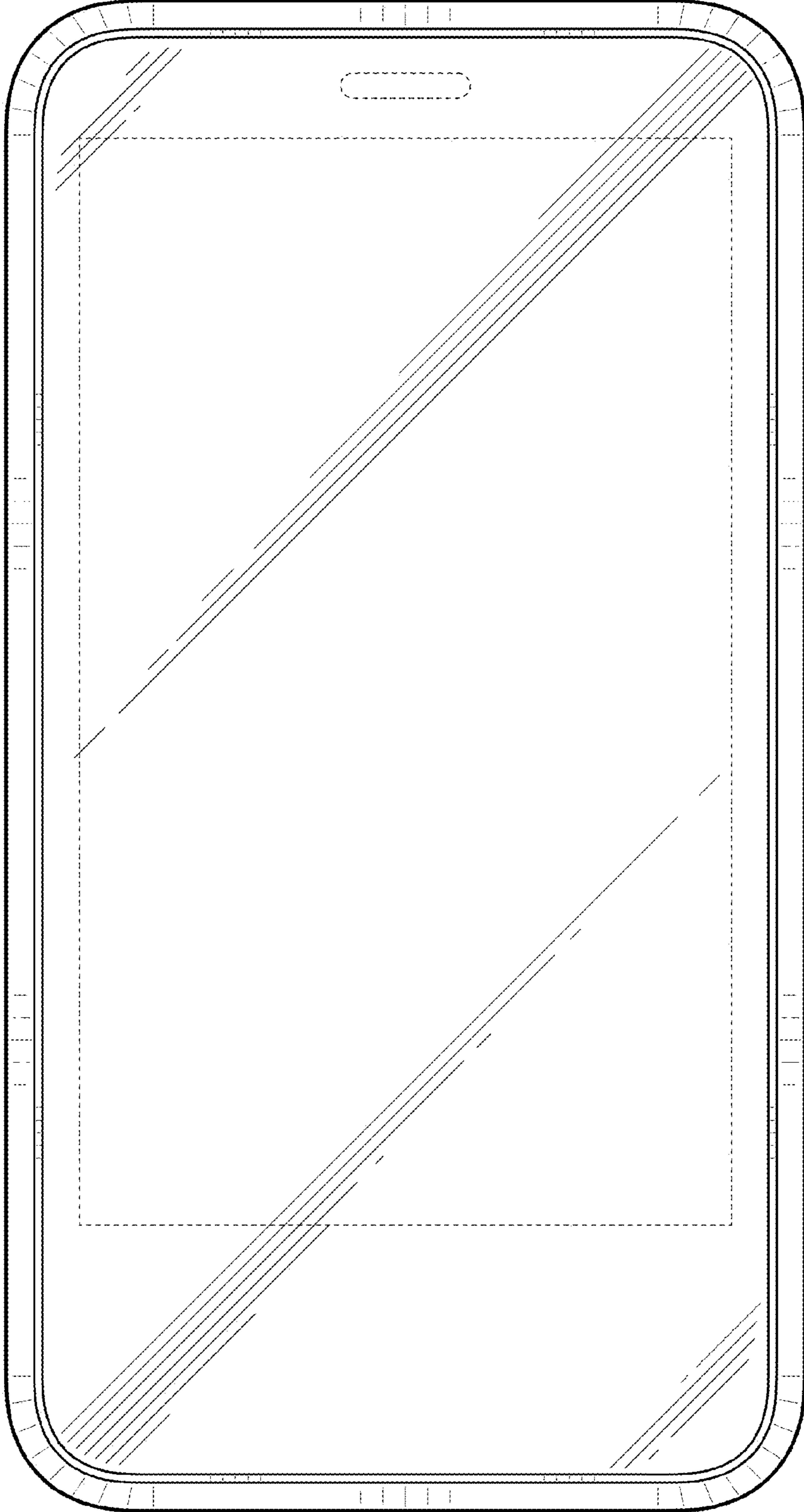

FIG. 2

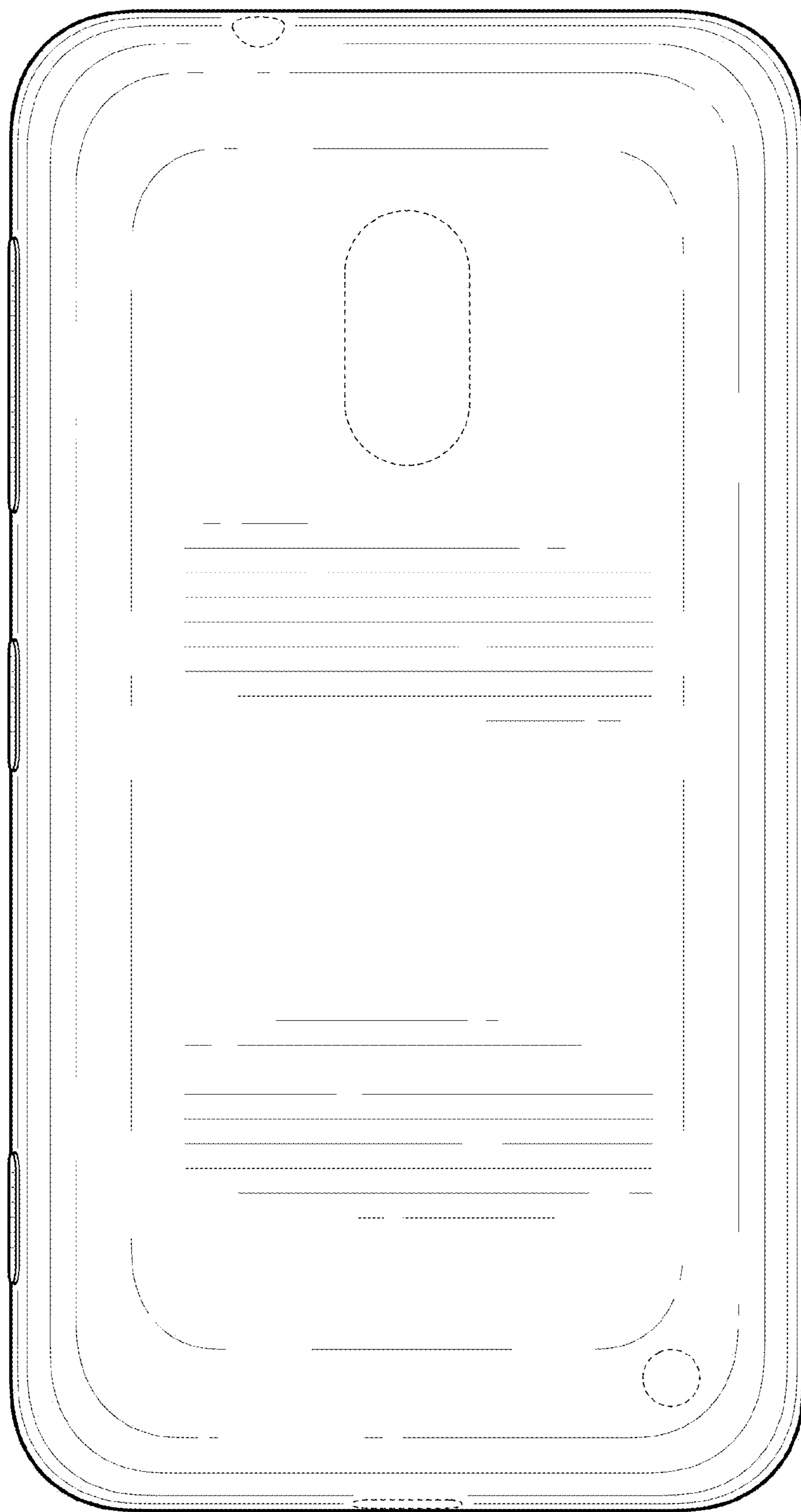

FIG. 3

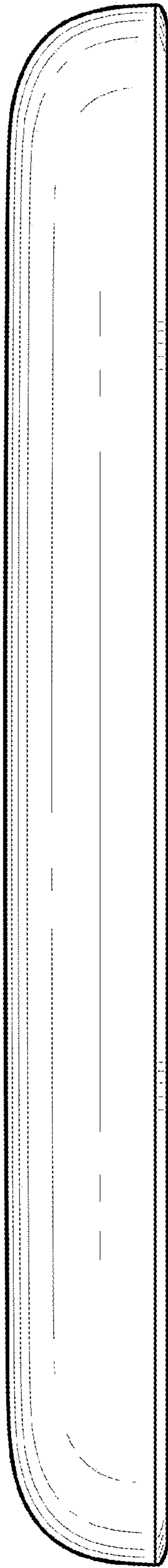

FIG. 4

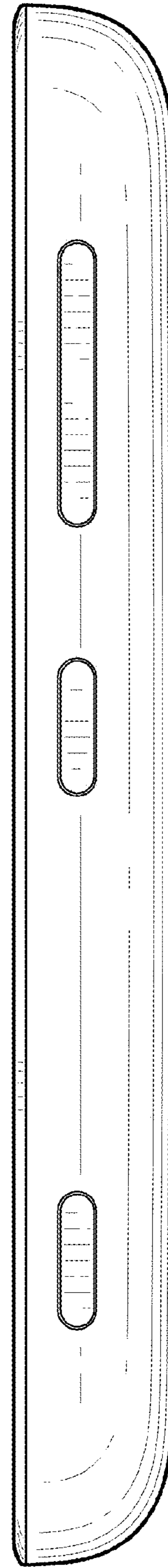

FIG. 5

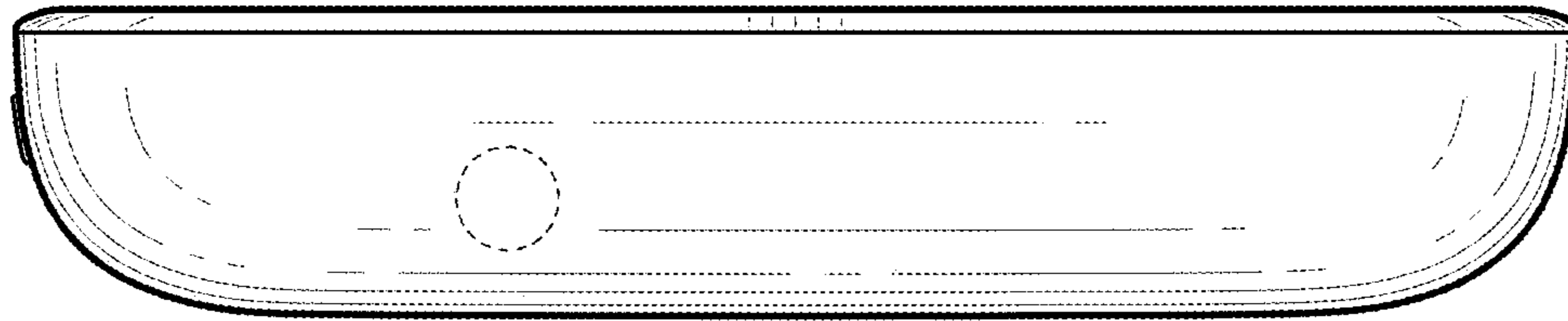

FIG. 6

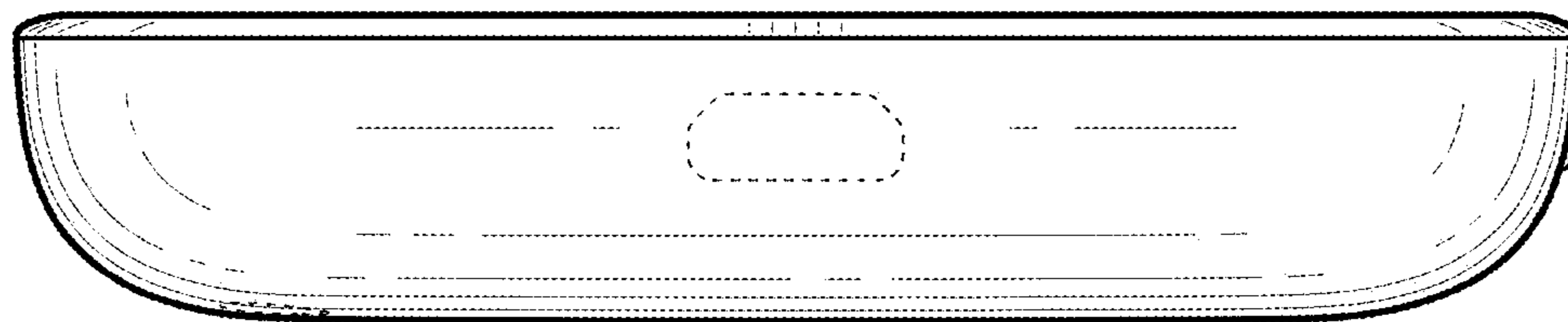

FIG. 7

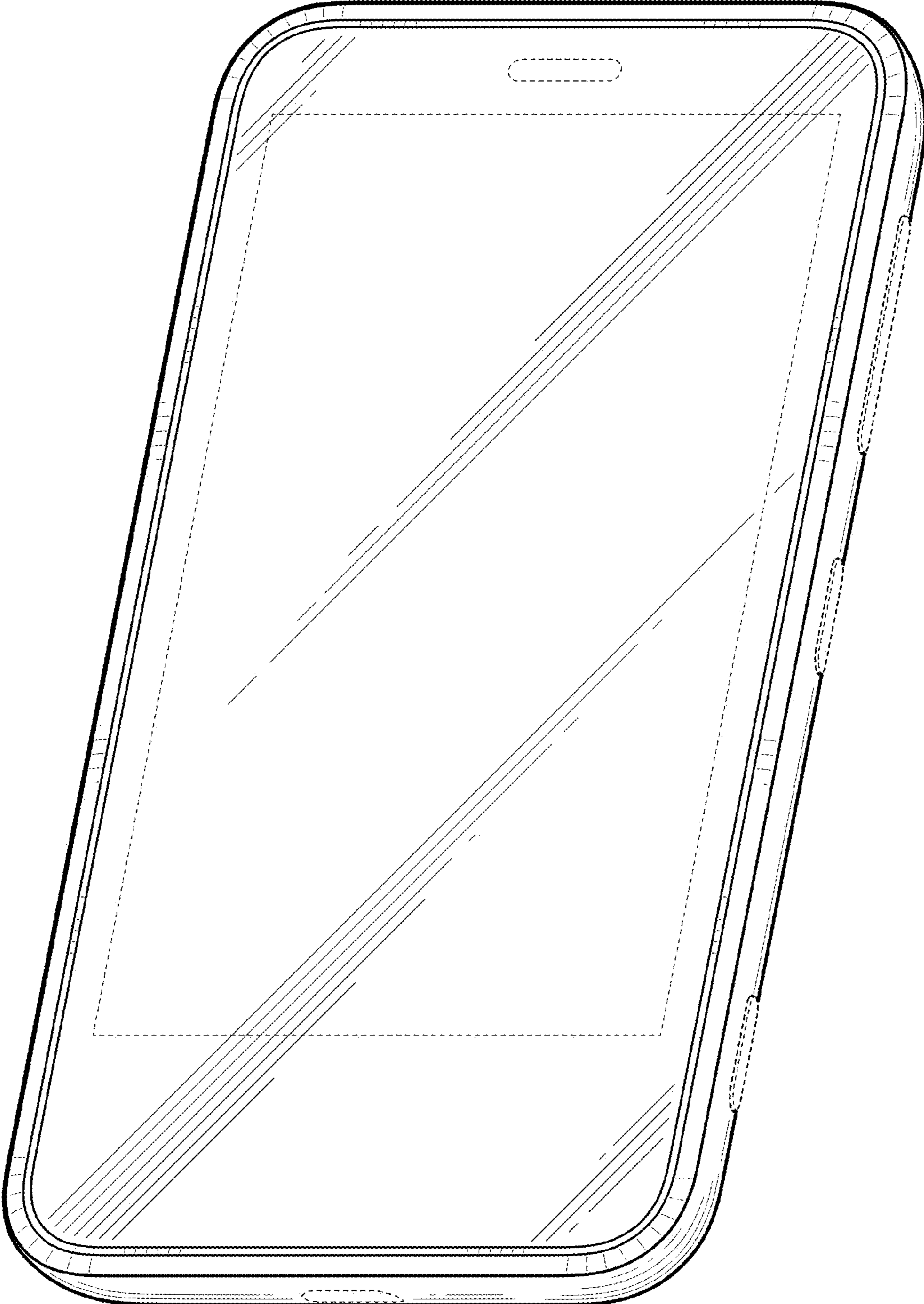

FIG. 8



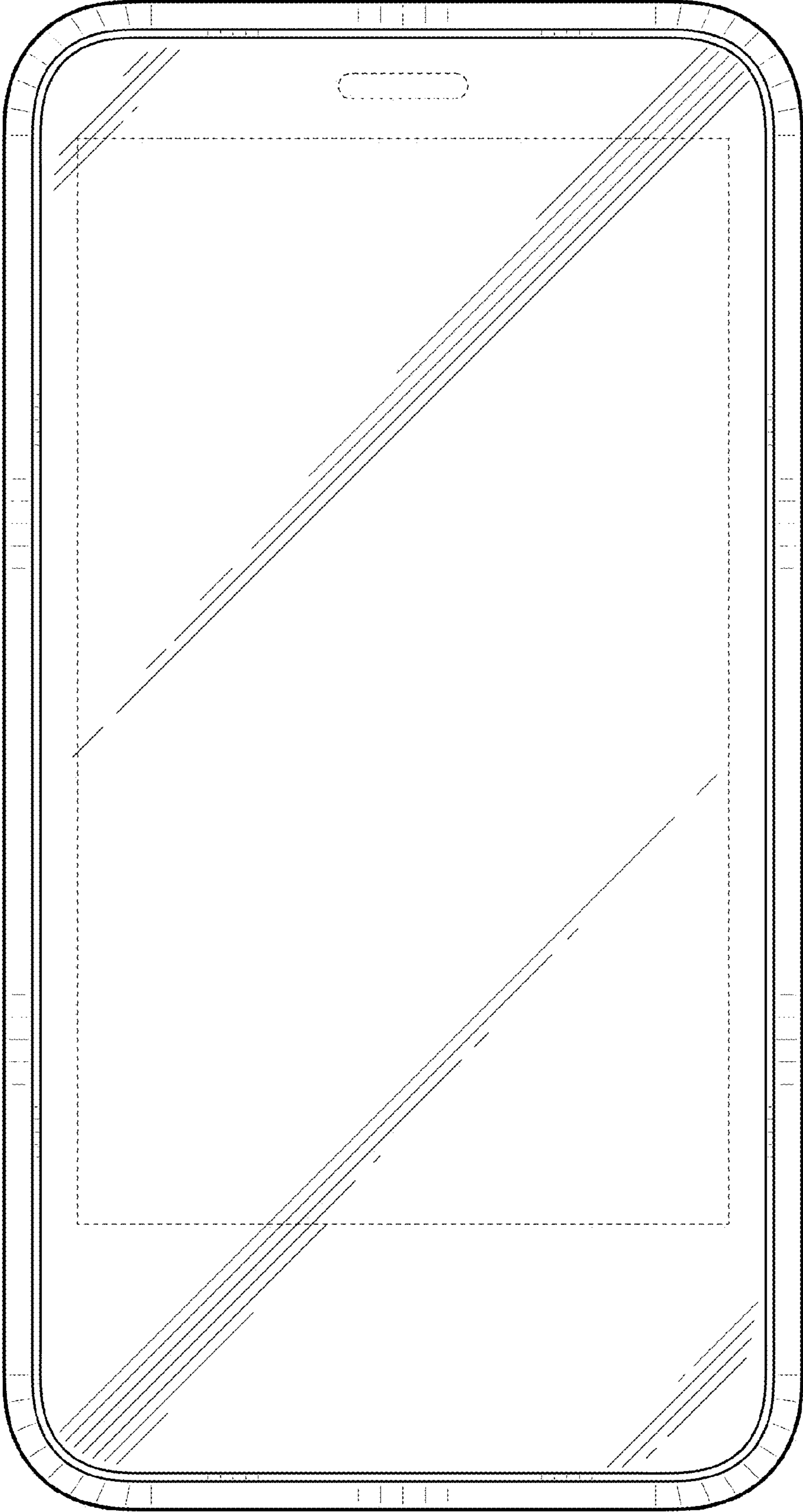

FIG. 9

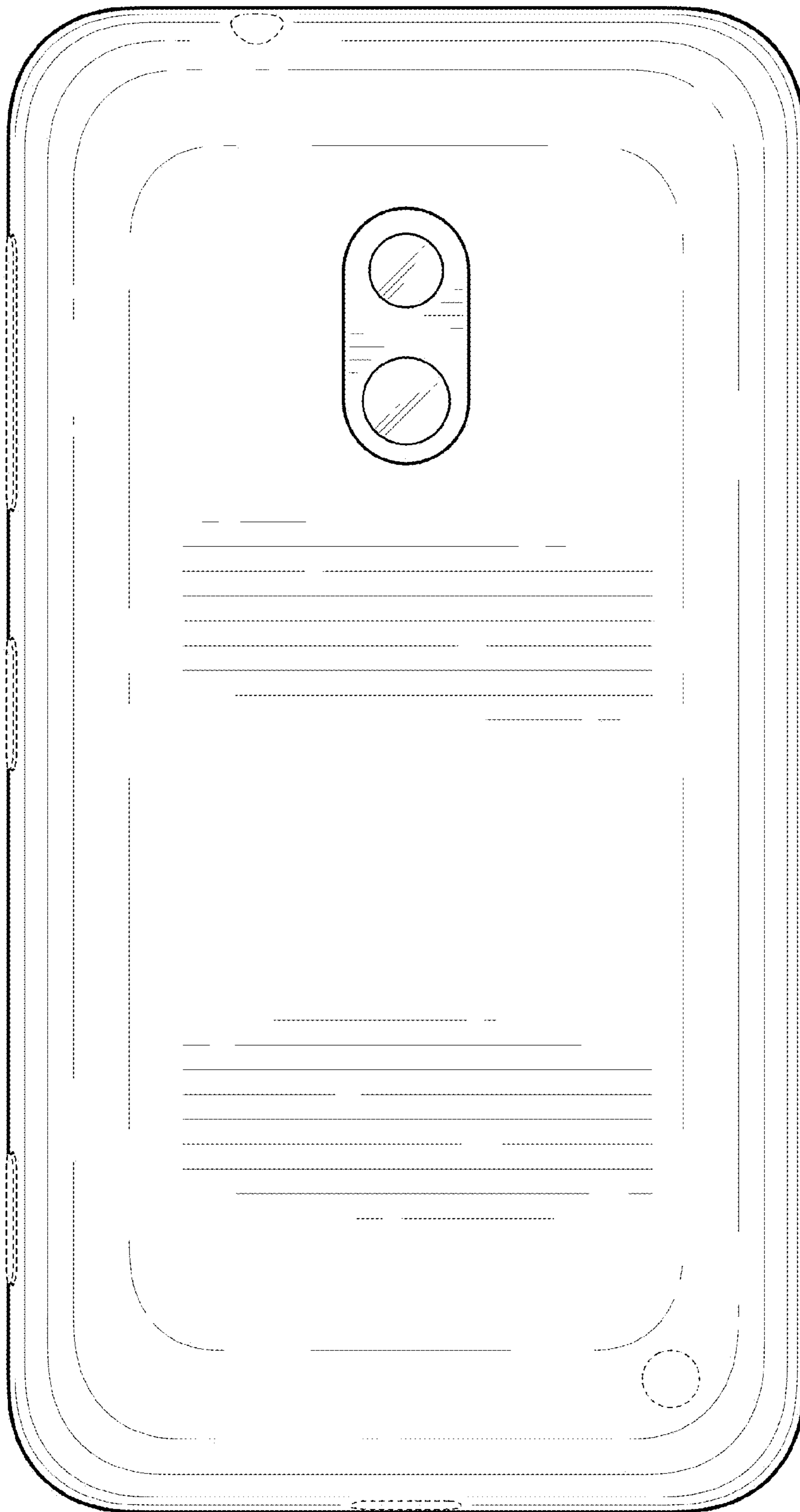

FIG. 10

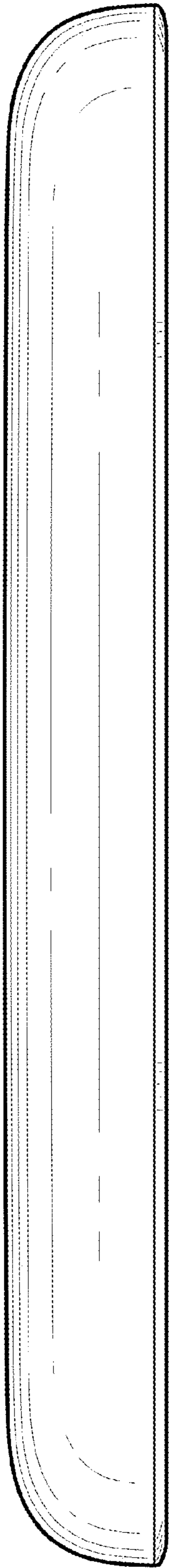

FIG. 11

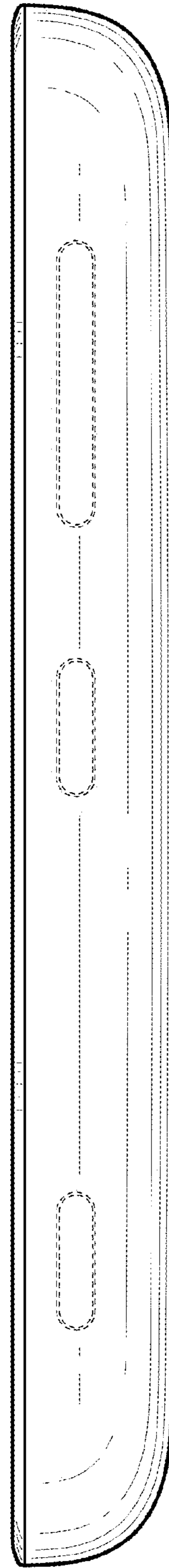

FIG. 12

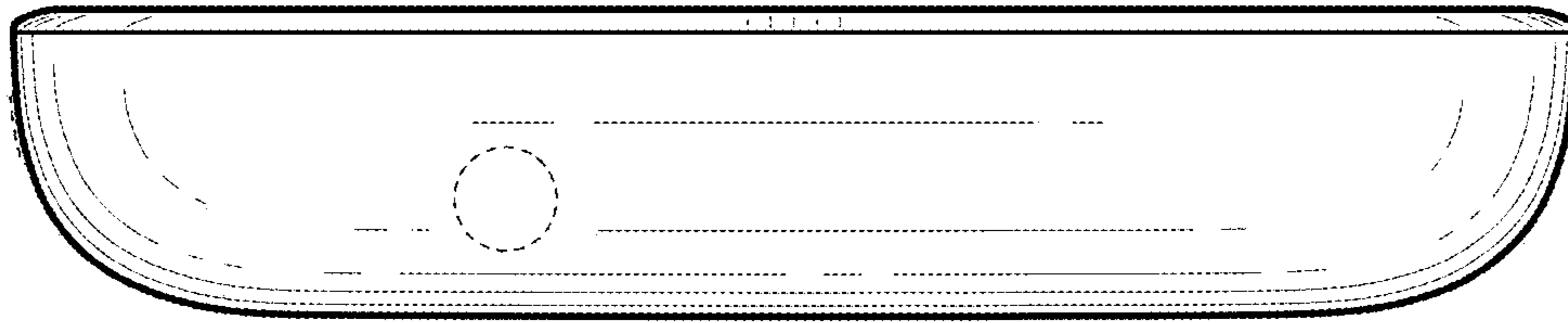

FIG. 13

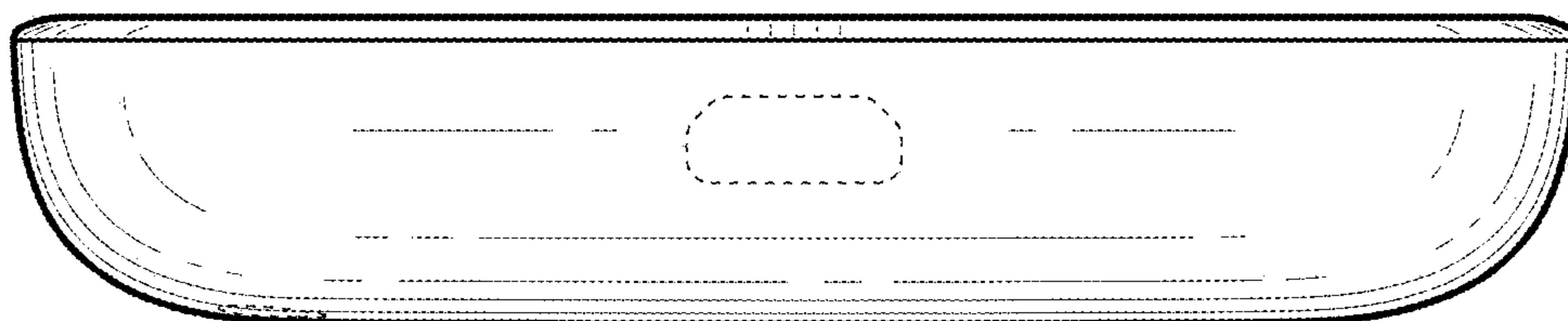

FIG. 14