

US00D722478S

(12) **United States Design Patent**
Zirinsky et al.

(10) **Patent No.:** **US D722,478 S**
(45) **Date of Patent:** **** Feb. 17, 2015**

- (54) **CUTTING BOARD**
- (71) Applicant: **Michael Walter Zirinsky**,
Schwenksville, PA (US)
- (72) Inventors: **Michael Walter Zirinsky**,
Schwenksville, PA (US); **Michael Kehs**,
Sellersville, PA (US)
- (73) Assignee: **Kellie Zirinsky**, Schwenksville, PA (US)
- (**) Term: **14 Years**
- (21) Appl. No.: **29/469,084**
- (22) Filed: **Oct. 7, 2013**

2,696,021 A	12/1954	Cox et al.	
4,015,330 A	4/1977	Popeil et al.	
4,065,115 A	12/1977	Popeil et al.	
4,464,450 A	8/1984	Teuscher	
5,106,666 A	4/1992	Fitzgerald et al.	
D337,024 S *	7/1993	Stickel, III	D7/549
5,386,654 A	2/1995	Kroenke	
D380,152 S *	6/1997	Correll	D9/430
D435,066 S *	12/2000	Hirschman	D19/52
D475,625 S	6/2003	Lin	
6,715,748 B2	4/2004	Thompson et al.	
6,889,963 B2	5/2005	Niknafs et al.	
D514,913 S *	2/2006	Dunn et al.	D8/71
D581,120 S	11/2008	Sofy et al.	
D583,199 S	12/2008	Johnson et al.	
D629,687 S	12/2010	Baker	
8,141,860 B2 *	3/2012	Goldman	269/303
D658,941 S	5/2012	Trussell	

(Continued)

Related U.S. Application Data

- (62) Division of application No. 29/439,838, filed on Dec. 15, 2012, now Pat. No. Des. 691,863.
- (51) **LOC (10) Cl.** **07-04**
- (52) **U.S. Cl.**
USPC **D7/698**
- (58) **Field of Classification Search**
CPC A47J 47/00; A47J 47/005; A47J 47/20;
A61F 13/512; B26D 7/0006; B26D 7/018;
B26D 7/20; B23D 21/00; B23K 37/04;
B23K 37/053; B23Q 16/001; B42F 9/001;
E04C 2/32
USPC D7/543, 549, 550.1, 553.7, 586,
D7/698-699; D8/71; D9/430; D19/88,
D19/113; D32/55-57; 99/444, 446, 449;
269/13-15, 289 R, 291, 297-298,
269/302.1, 303, 315; 281/45; 428/131
See application file for complete search history.

(56) **References Cited**

U.S. PATENT DOCUMENTS

1,693,761 A	12/1928	Macripo	
1,745,099 A	1/1930	Kasper	
D142,231 S *	8/1945	Snoke	D7/553.7

Primary Examiner — Ricky Pham

(74) *Attorney, Agent, or Firm* — Collard & Roe, P.C.

(57) **CLAIM**

The ornamental design for a cutting board, as shown and described.

DESCRIPTION

FIG. 1 is a front and side perspective view of a cutting board showing our new design;
 FIG. 2 is a front view thereof;
 FIG. 3 is a back view thereof;
 FIG. 4 is a side view thereof;
 FIG. 5 is a side view thereof which is opposite the view of FIG. 4;
 FIG. 6 a top view thereof based upon the orientation of FIG. 1; and,
 FIG. 7 is a bottom view thereof based upon the orientation of FIG. 1.
 The areas shown in broken lines show environmental structure and form no part of the claimed design.

1 Claim, 3 Drawing Sheets

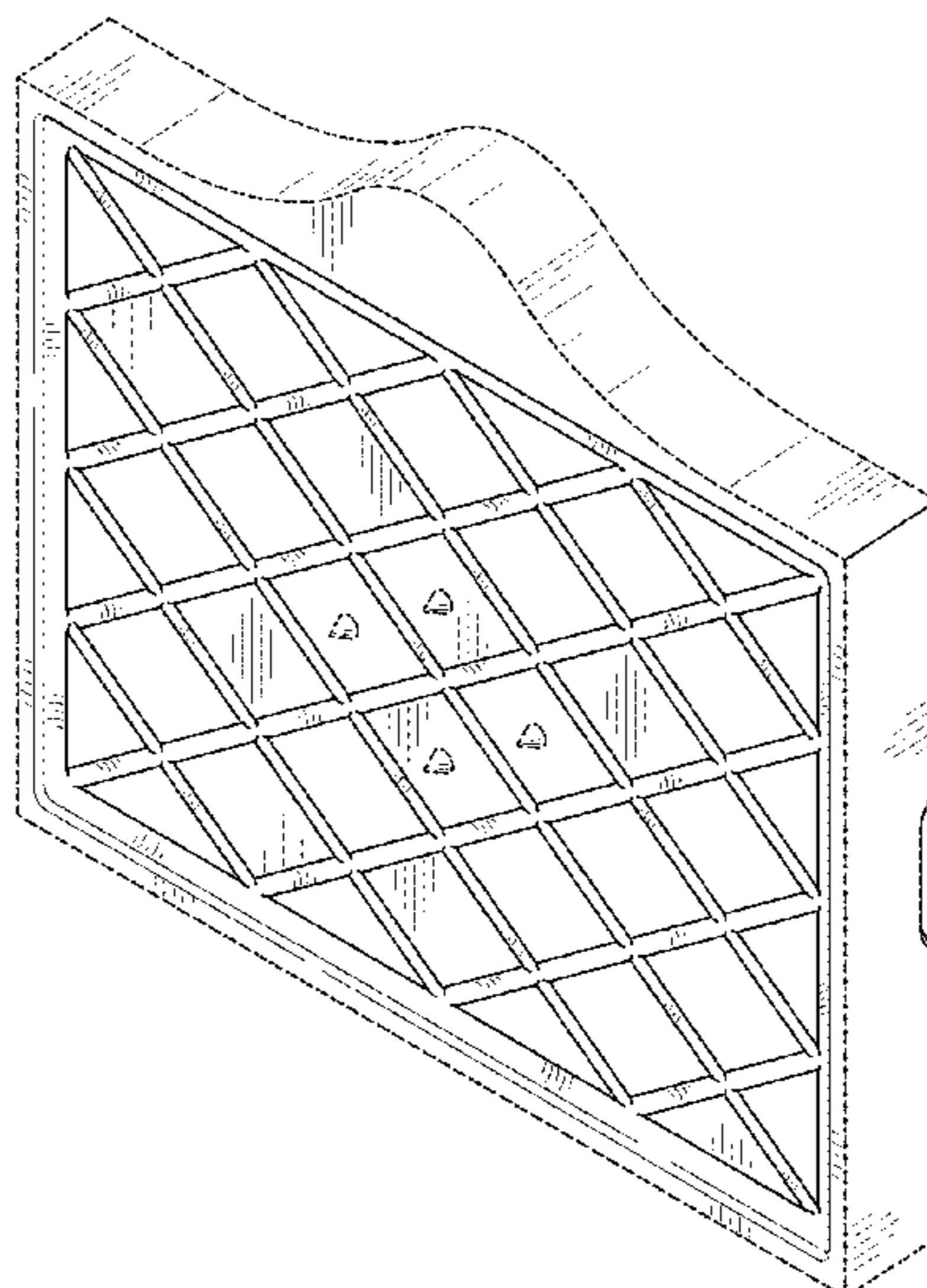

(56)

References Cited

U.S. PATENT DOCUMENTS

D679,557 S * 4/2013 Wardell D7/698
D684,022 S * 6/2013 Kim D7/698
D691,863 S 10/2013 Zirinsky et al.

D694,333 S * 11/2013 Tunis et al. D19/88
2004/0207140 A1 * 10/2004 Johnson et al. 269/289 R
2005/0202208 A1 * 9/2005 Kelly 428/131
2007/0126224 A1 * 6/2007 Isaacs 281/45
2010/0009119 A1 * 1/2010 Herron, III 428/131

* cited by examiner

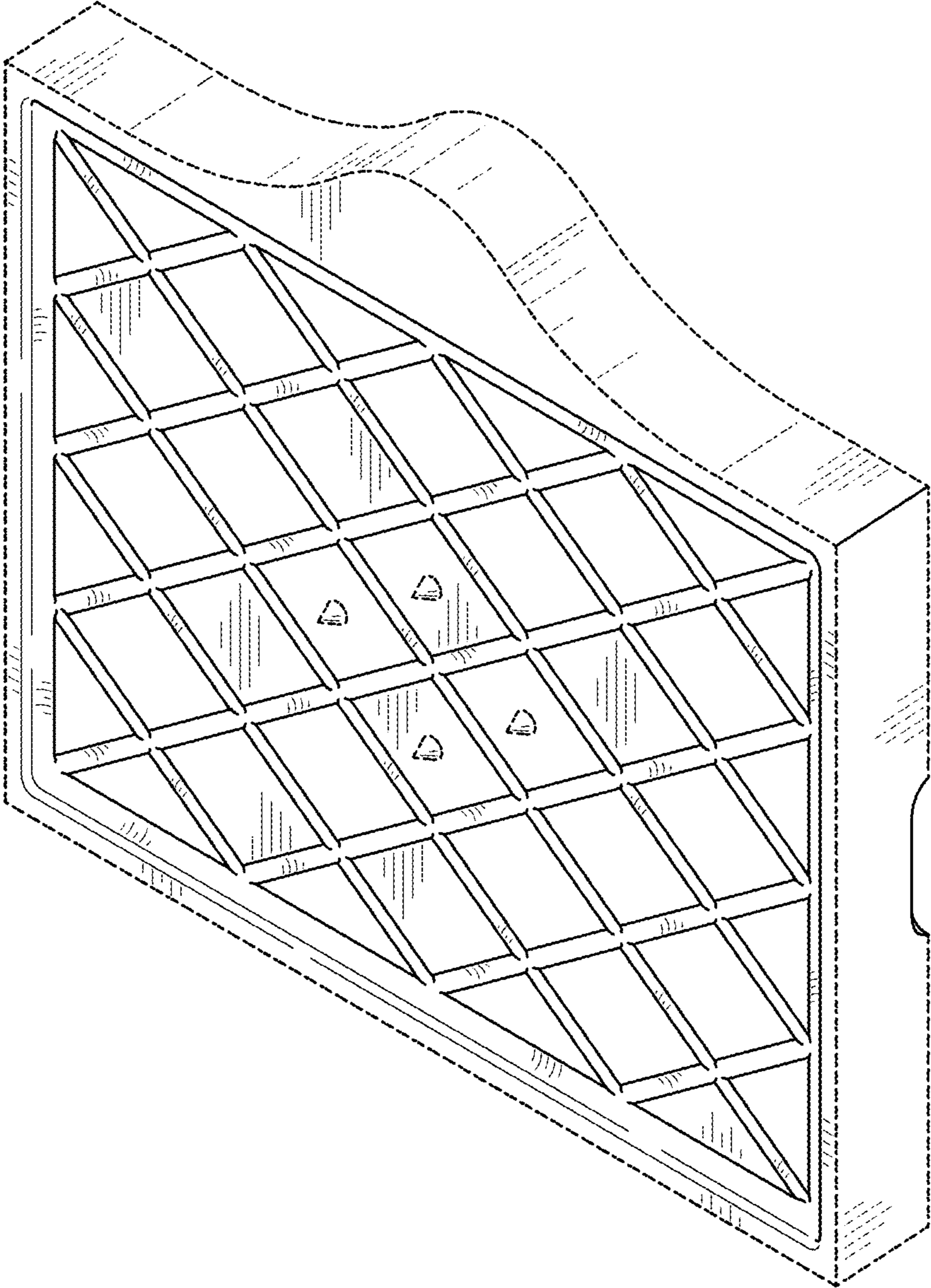

FIG. 1

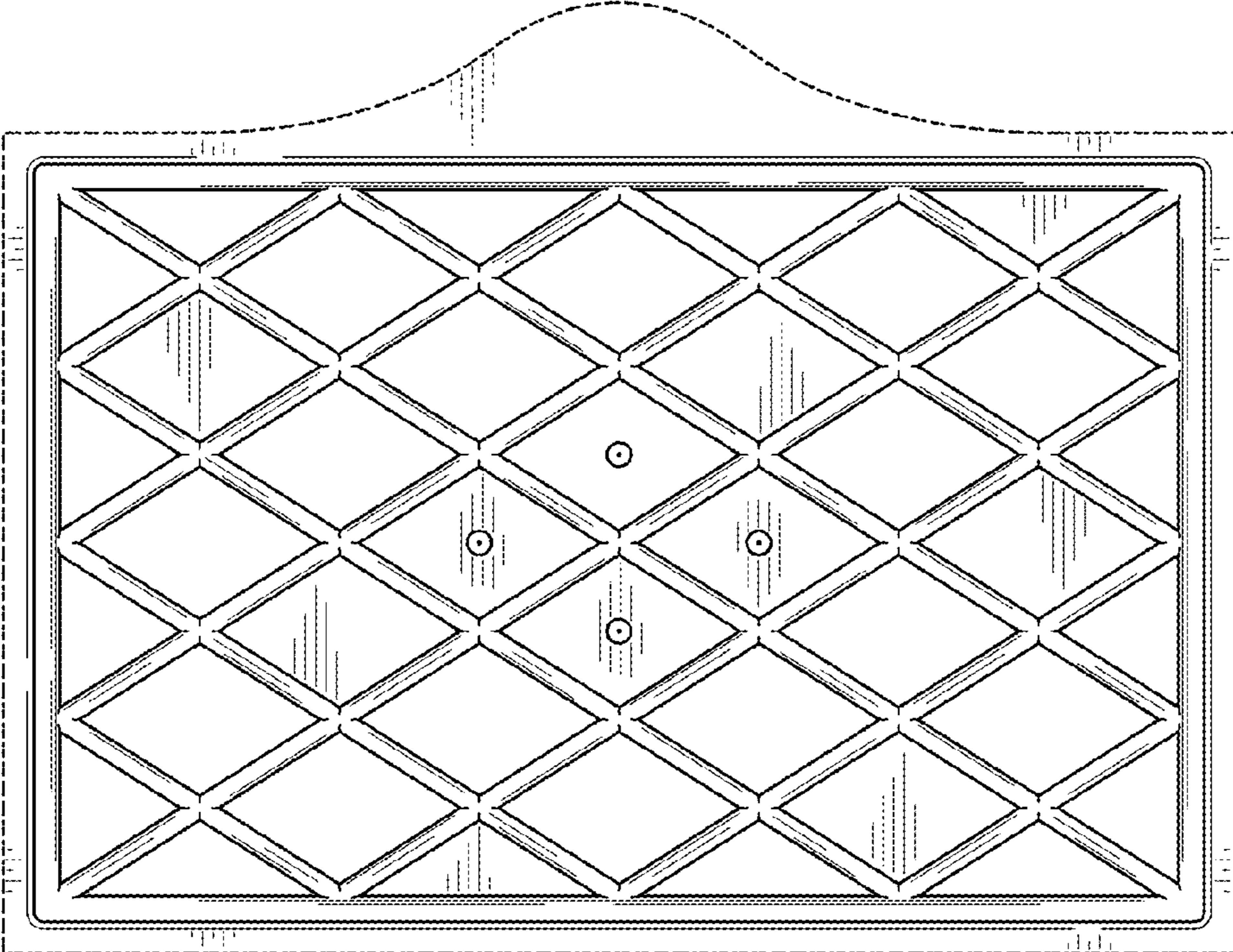

FIG. 2

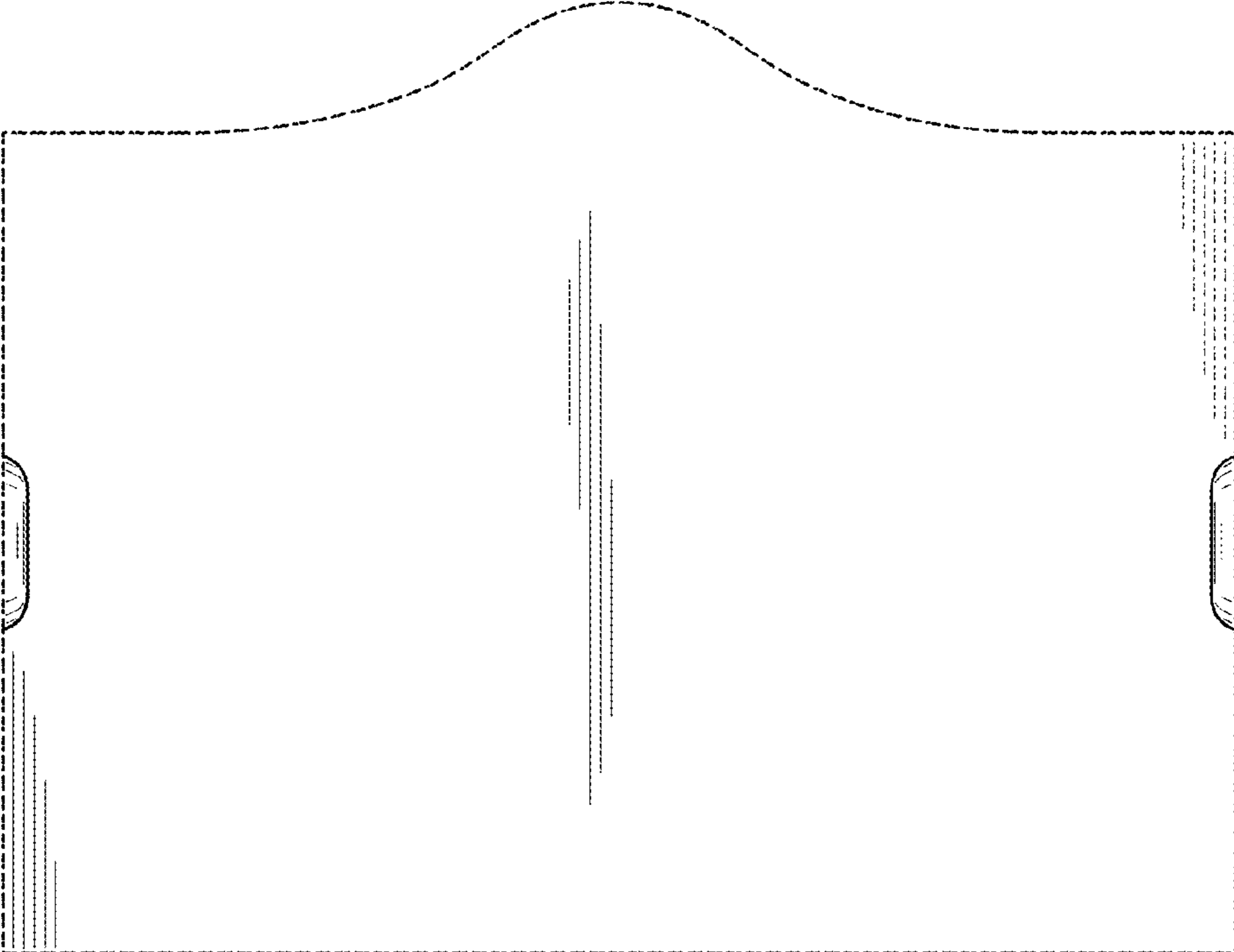

FIG. 3

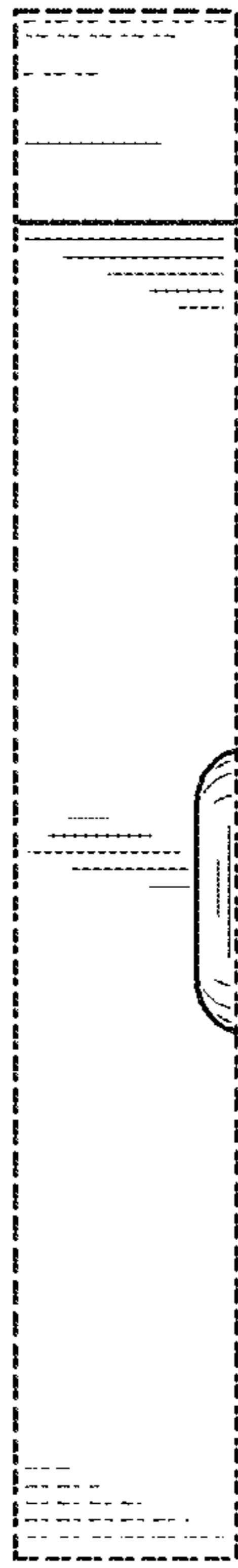

FIG. 4

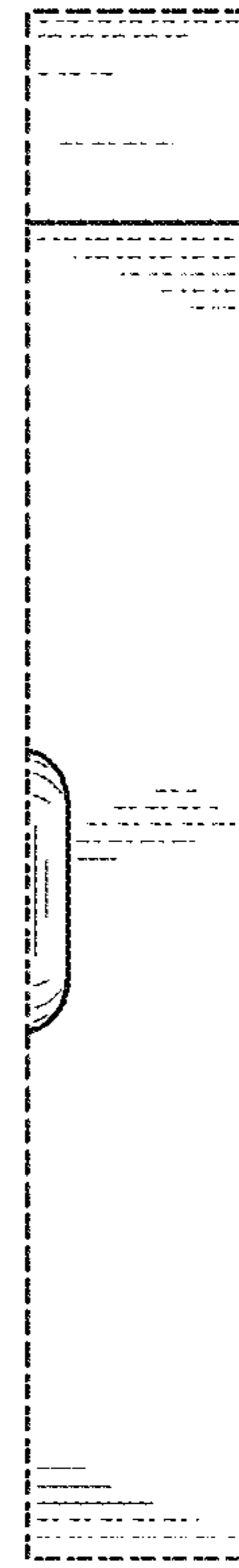

FIG. 5

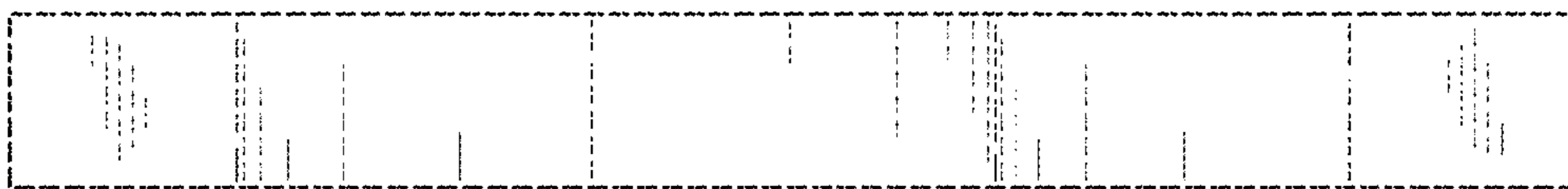

FIG. 6

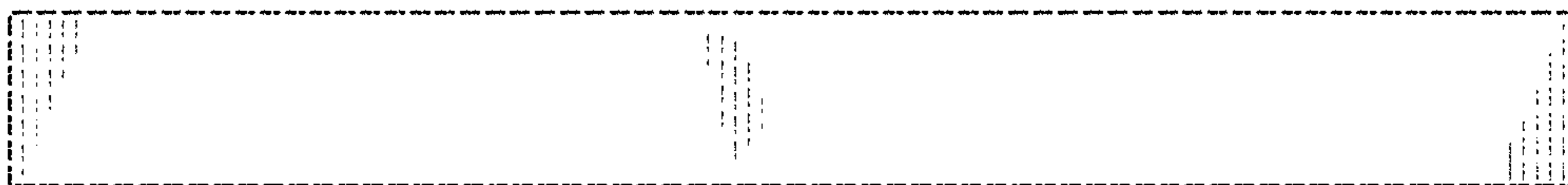

FIG. 7