



US00D722464S

(12) **United States Design Patent**
Williams

(10) **Patent No.:** **US D722,464 S**

(45) **Date of Patent:** **** Feb. 17, 2015**

(54) **JUG**

(71) Applicant: **Robert Welch Designs Ltd.**, Chipping
Campden, Gloucestershire (GB)

(72) Inventor: **Ruth Natasha Williams**, Salisbury (GB)

(73) Assignee: **Robert Welch Designs Ltd**, Chipping
Campden, Gloucestershire (GB)

(**) Term: **14 Years**

(21) Appl. No.: **29/460,899**

(22) Filed: **Jul. 16, 2013**

(30) **Foreign Application Priority Data**

Jan. 16, 2013	(EM)	001357842-0001
Jan. 16, 2013	(EM)	001357842-0002
Jan. 16, 2013	(EM)	001357842-0005
Jan. 16, 2013	(EM)	001357842-0006

(51) **LOC (10) Cl.** **07-01**

(52) **U.S. Cl.**
USPC **D7/319; D7/316**

(58) **Field of Classification Search**
CPC A47G 19/14
USPC D7/312, 300, 316-319, 310, 309, 600,
D7/598; 222/465.1, 189.06, 571; 215/398,
215/235, 12.1; 220/713, 663; 99/303
See application file for complete search history.

(56) **References Cited**

U.S. PATENT DOCUMENTS

D66,714 S *	2/1925	Sebring et al.	D7/319
D72,282 S *	3/1927	Schmidt	D7/319
D72,498 S *	4/1927	Scavullo	D7/319
2,442,047 A *	5/1948	Kemper	222/571
D152,159 S *	12/1948	Kemper	D7/319

(Continued)

Primary Examiner — Marianne Pandozzi

(74) *Attorney, Agent, or Firm* — MacMillan, Sobanski &
Todd LLC

(57) **CLAIM**
The ornamental design for a jug, as shown and described.

DESCRIPTION

FIG. 1 is a perspective view as seen from the upper left front of a jug showing my new design;
 FIG. 2 is a left side elevational view thereof;
 FIG. 3 is a right side elevational view thereof;
 FIG. 4 is a front elevational view thereof;
 FIG. 5 is a rear elevational view thereof;
 FIG. 6 is a top plan view thereof;
 FIG. 7 is a bottom plan view thereof;
 FIG. 8 is a perspective view as seen from the upper left front of a second embodiment of a jug showing my new design;
 FIG. 9 is a right side elevational view thereof;
 FIG. 10 is a left side elevational view thereof;
 FIG. 11 is a rear elevational view thereof;
 FIG. 12 is a front elevational view thereof;
 FIG. 13 is a top plan view thereof;
 FIG. 14 is a bottom plan view thereof;
 FIG. 15 is a perspective view as seen from the upper left front of a third embodiment of a jug showing my new design;
 FIG. 16 is a left side elevational view thereof;
 FIG. 17 is a right side elevational view thereof;
 FIG. 18 is a front elevational view thereof;
 FIG. 19 is a rear elevational view thereof;
 FIG. 20 is a top plan view thereof;
 FIG. 21 is a bottom plan view thereof;
 FIG. 22 is a perspective view as seen from the upper left front of a fourth embodiment of a jug showing my new design;
 FIG. 23 is a right side elevational view thereof;
 FIG. 24 is a left side elevational view thereof;
 FIG. 25 is a rear elevational view thereof;
 FIG. 26 is a front elevational view thereof;
 FIG. 27 is a top plan view thereof; and,
 FIG. 28 is a bottom plan view thereof.

1 Claim, 20 Drawing Sheets

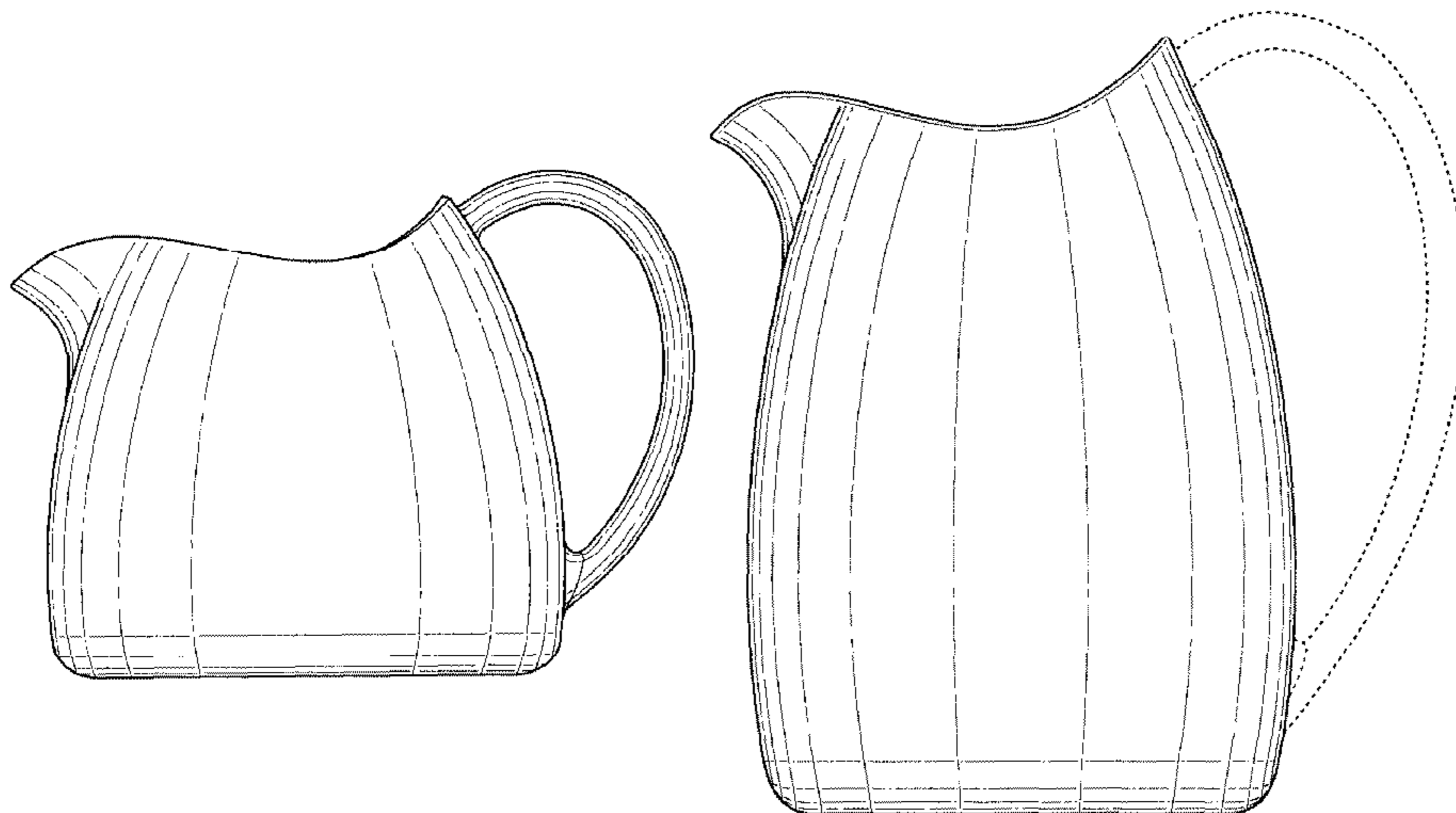

(56)

References Cited

U.S. PATENT DOCUMENTS

D160,346 S *	10/1950	Silcox	D7/319	D319,753 S *	9/1991	Unger	D7/319
D162,271 S *	2/1951	Wright	D7/319	D377,882 S *	2/1997	Huang	D7/317
D165,042 S *	10/1951	Zeisel	D7/319	D393,174 S *	4/1998	Mork et al.	D7/318
D171,241 S *	1/1954	Barnhart	D7/319	D472,105 S *	3/2003	Jørgensen	D7/598
D176,826 S *	1/1956	Sacia et al.	D7/319	D490,639 S *	6/2004	Kling	D7/318
D179,370 S *	12/1956	Barnhart	D7/319	D491,417 S *	6/2004	Bodum	D7/505
D181,348 S *	11/1957	Dube	D7/318	D523,280 S *	6/2006	Bertulis	D7/317
D184,814 S *	4/1959	James	D7/319	D584,556 S *	1/2009	Bodum	D7/318
D211,382 S *	6/1968	Erenhouse	D7/319	D587,958 S *	3/2009	Schosser	D7/318
D266,729 S *	11/1982	Blake	D7/318	D655,374 S *	3/2012	Sheppard et al.	D23/209
D280,061 S *	8/1985	Mugglin	D7/316	D679,537 S *	4/2013	Muspratt-Williams	
D303,904 S *	10/1989	Wolfenden	D7/317			et al.	D7/319
D319,554 S *	9/1991	Unger	D7/319	D680,790 S *	4/2013	Bell et al.	D7/317
				D689,727 S *	9/2013	Muspratt-Williams	
						et al.	D7/319
				D707,487 S *	6/2014	Weernink	D7/318

* cited by examiner

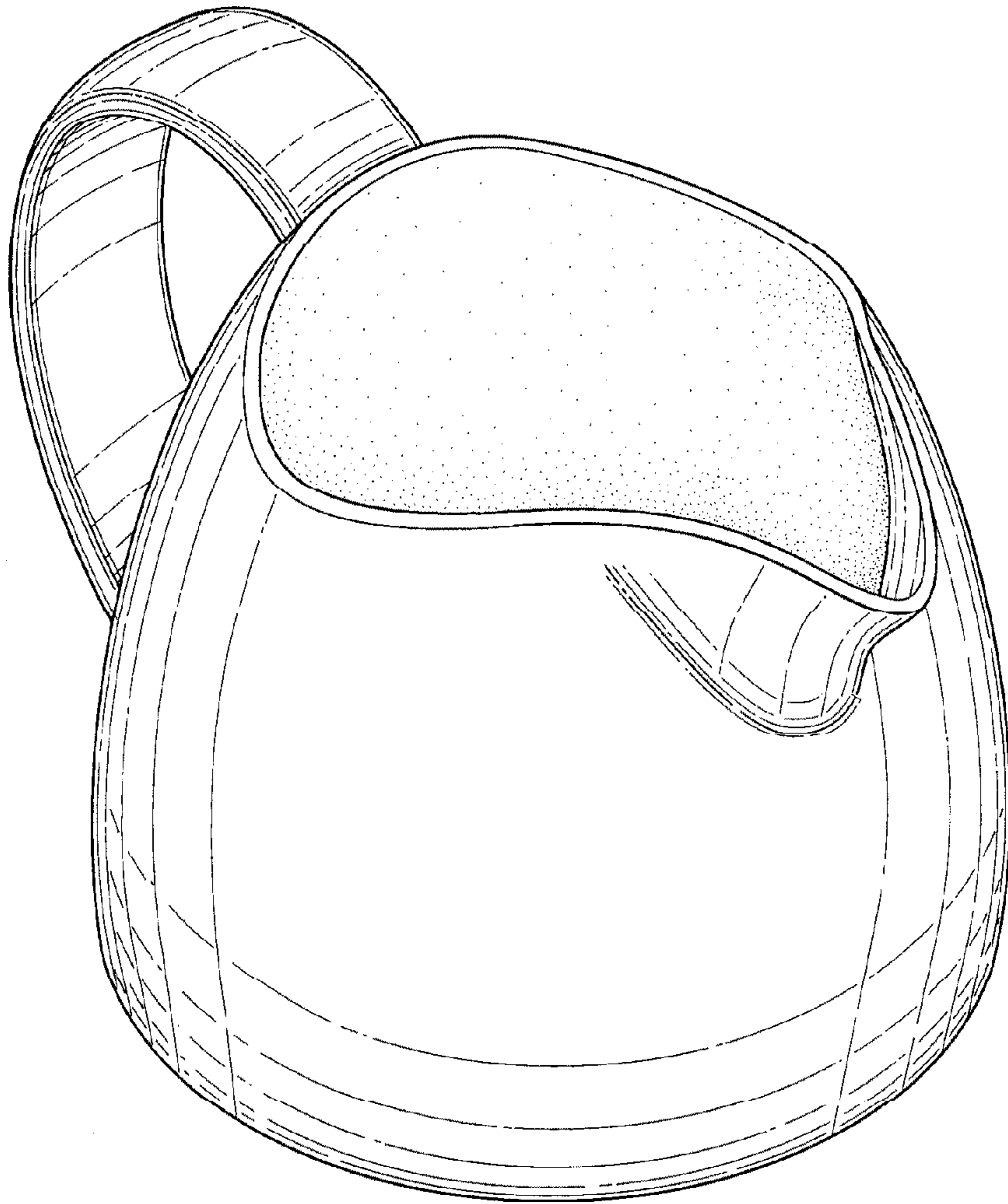

FIG. 1

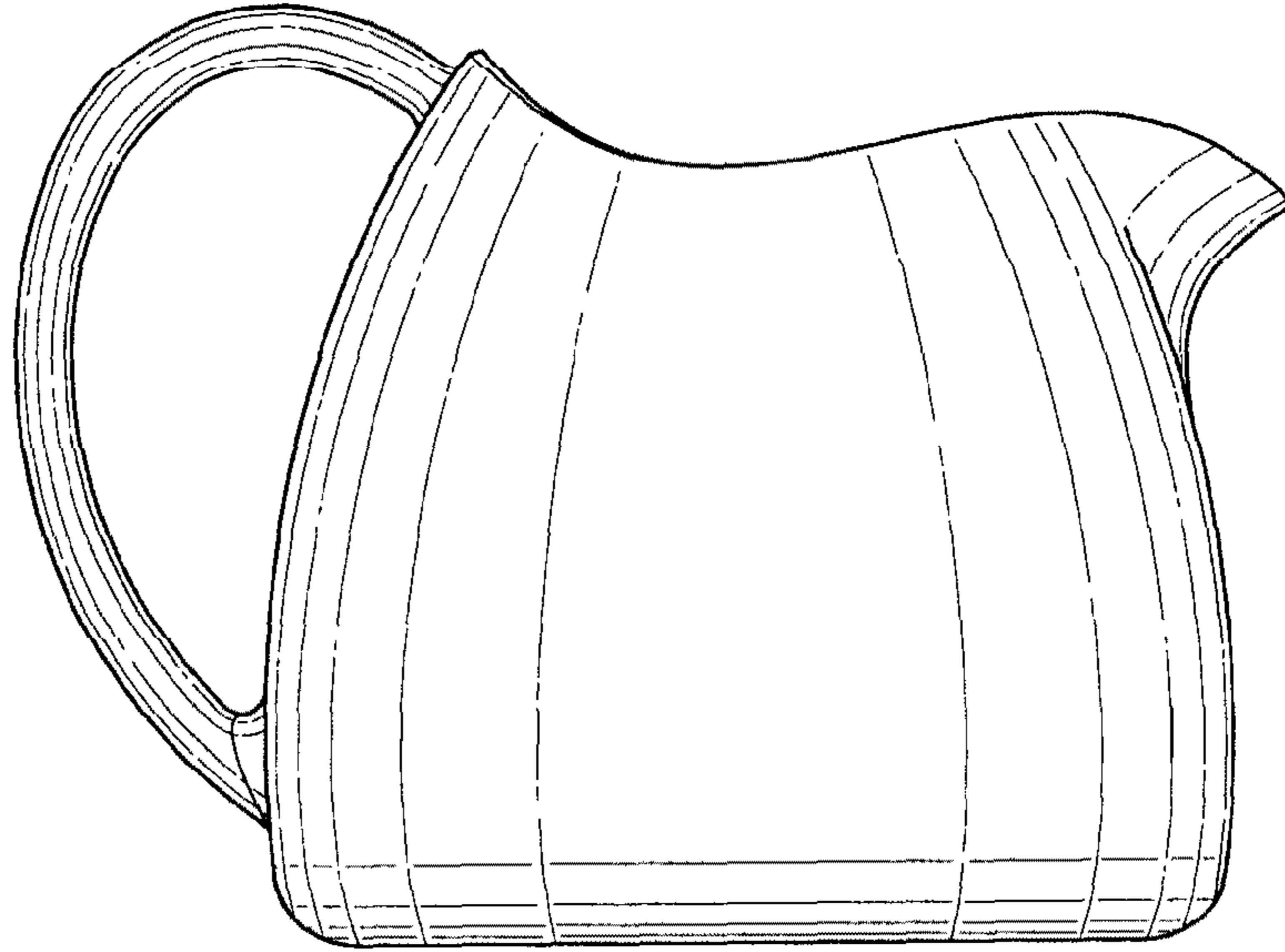

FIG. 2

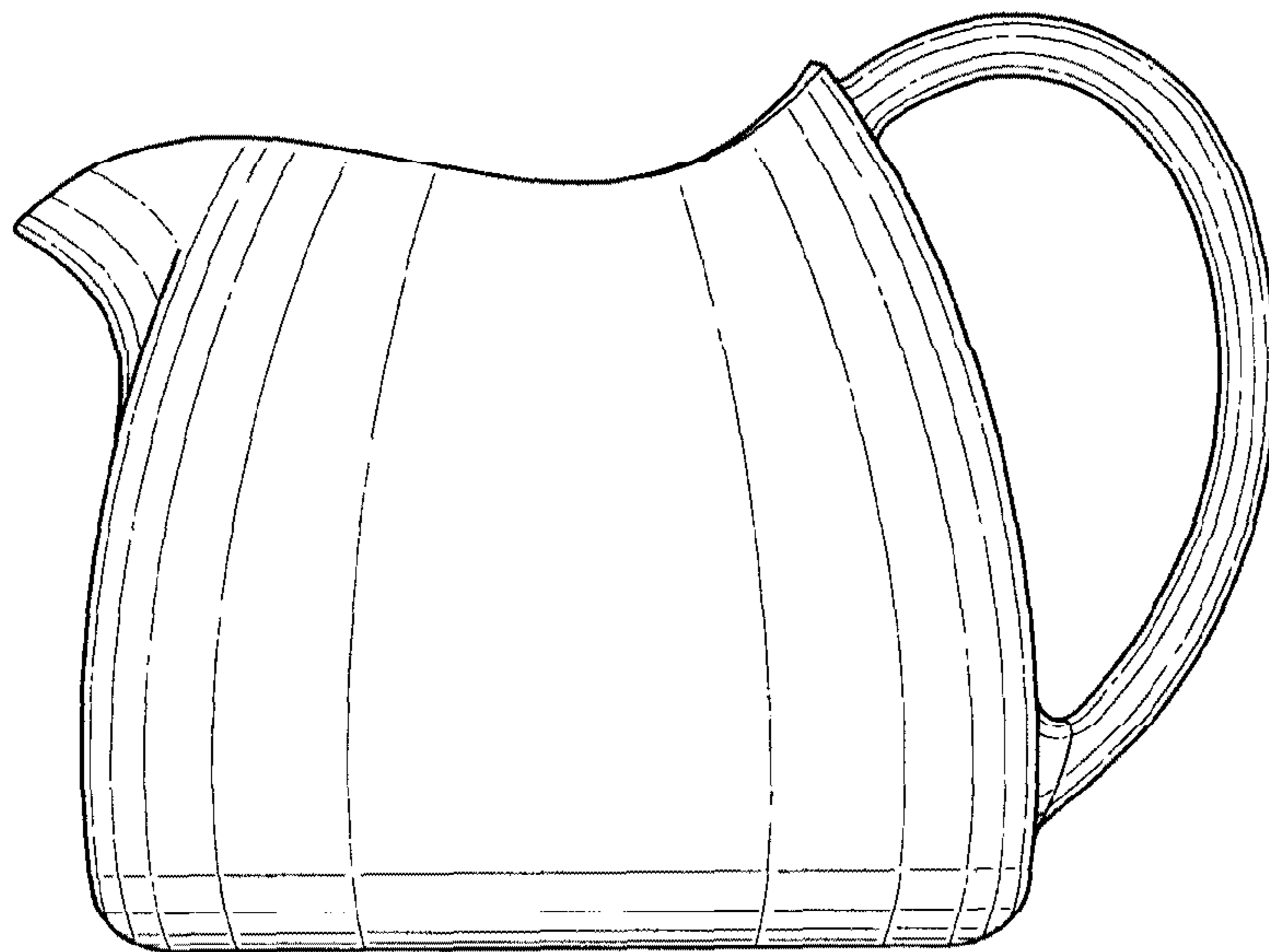

FIG. 3

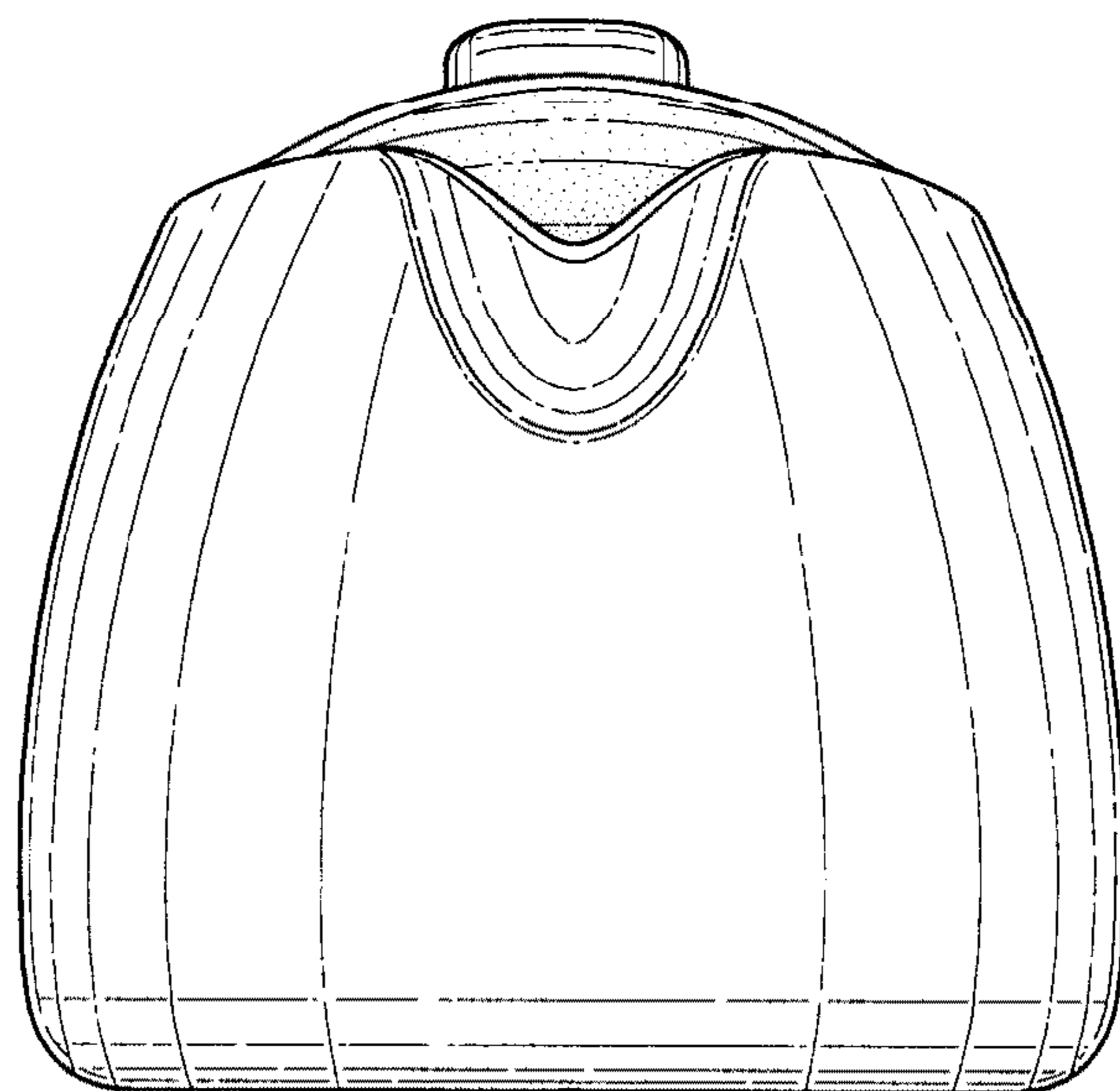

FIG. 4

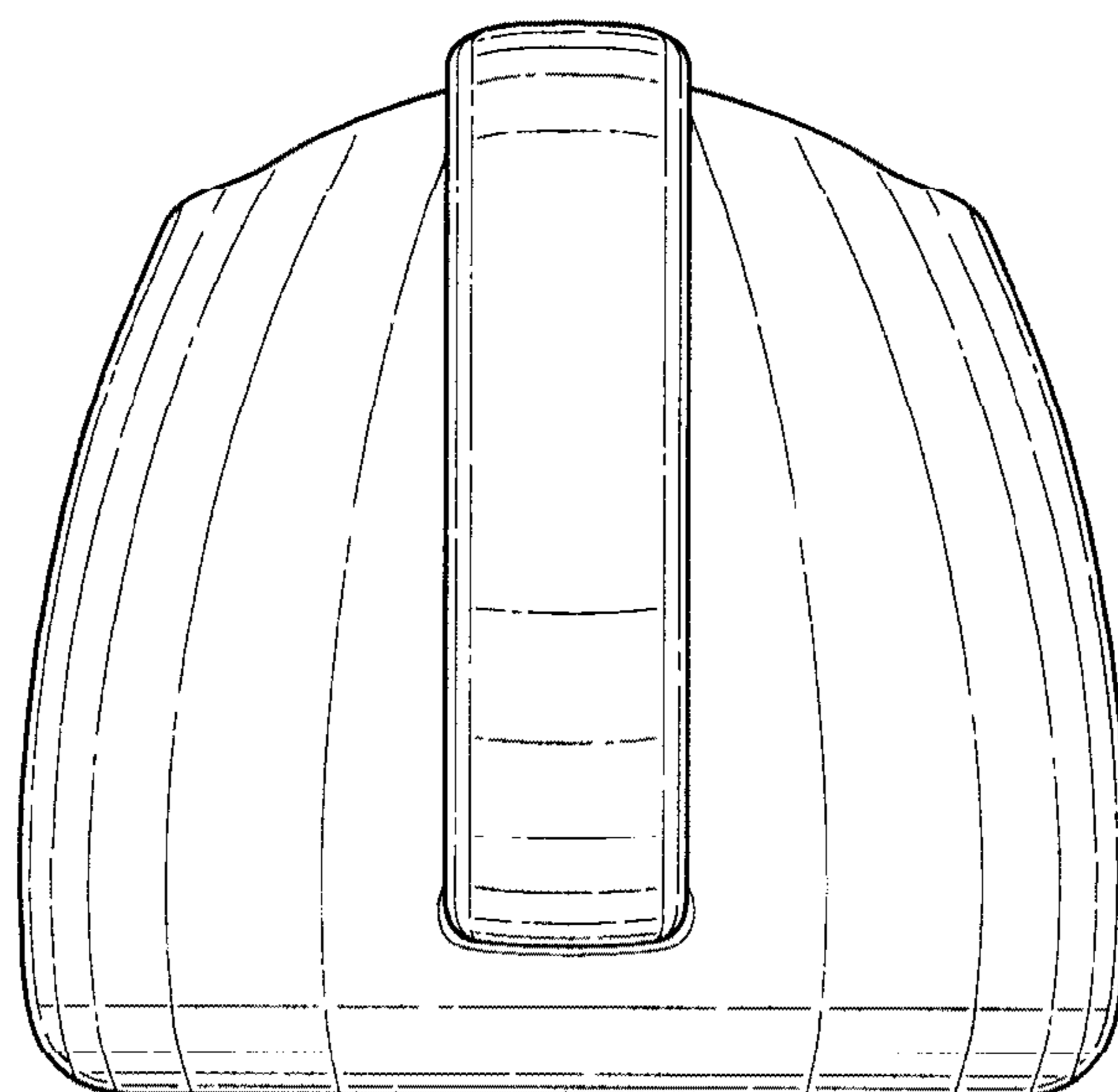

FIG. 5

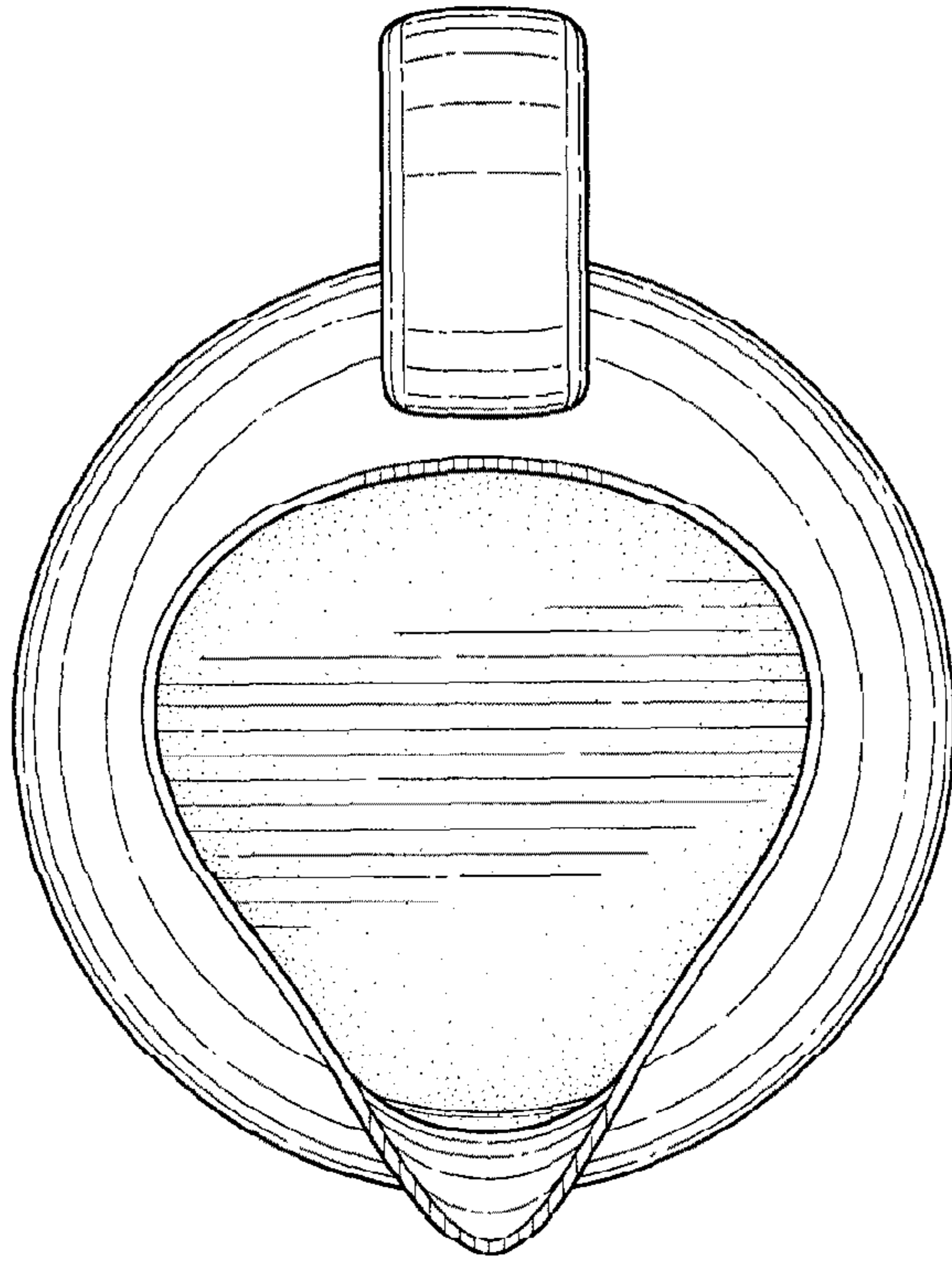

FIG. 6

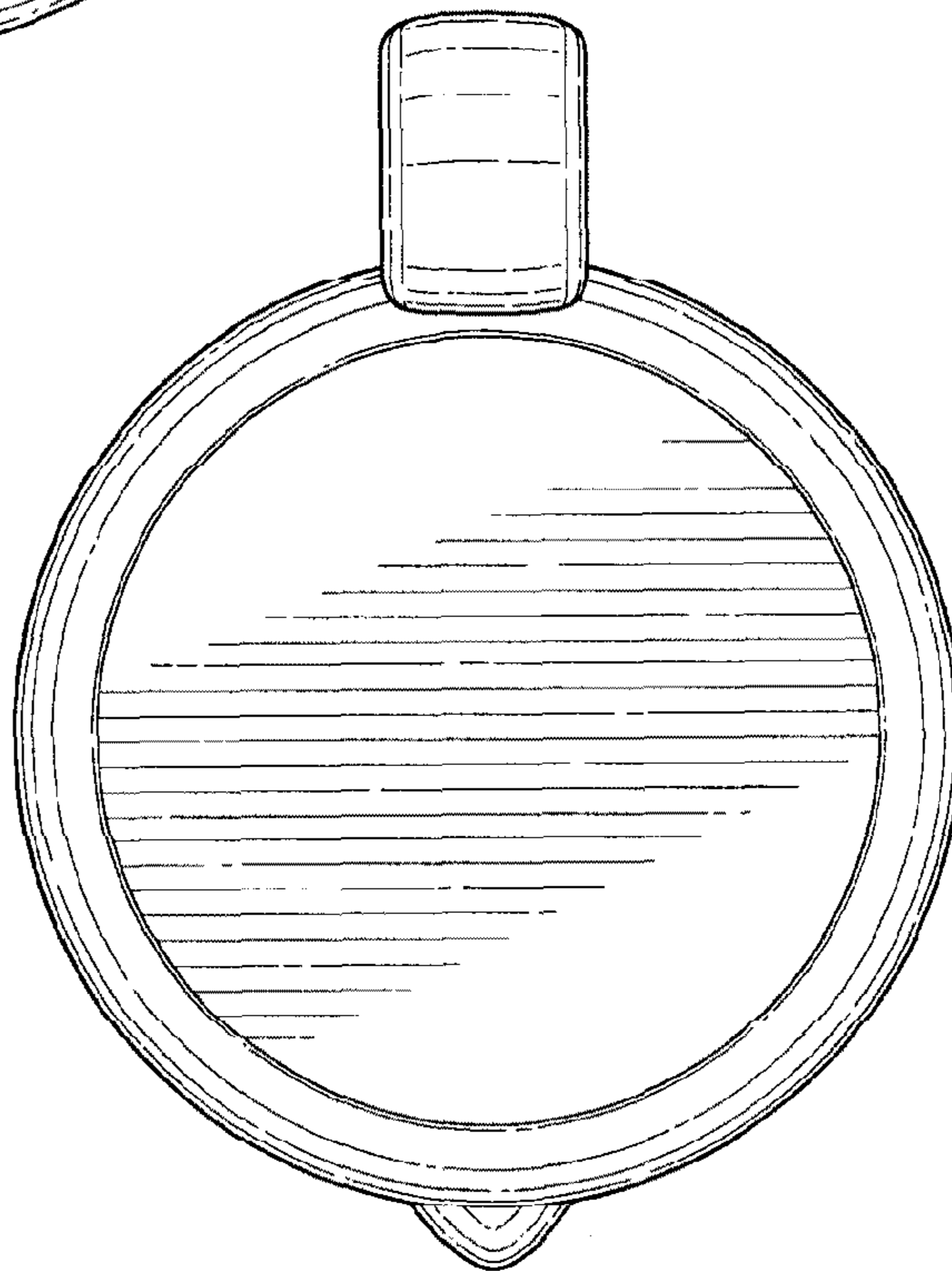

FIG. 7



FIG. 8

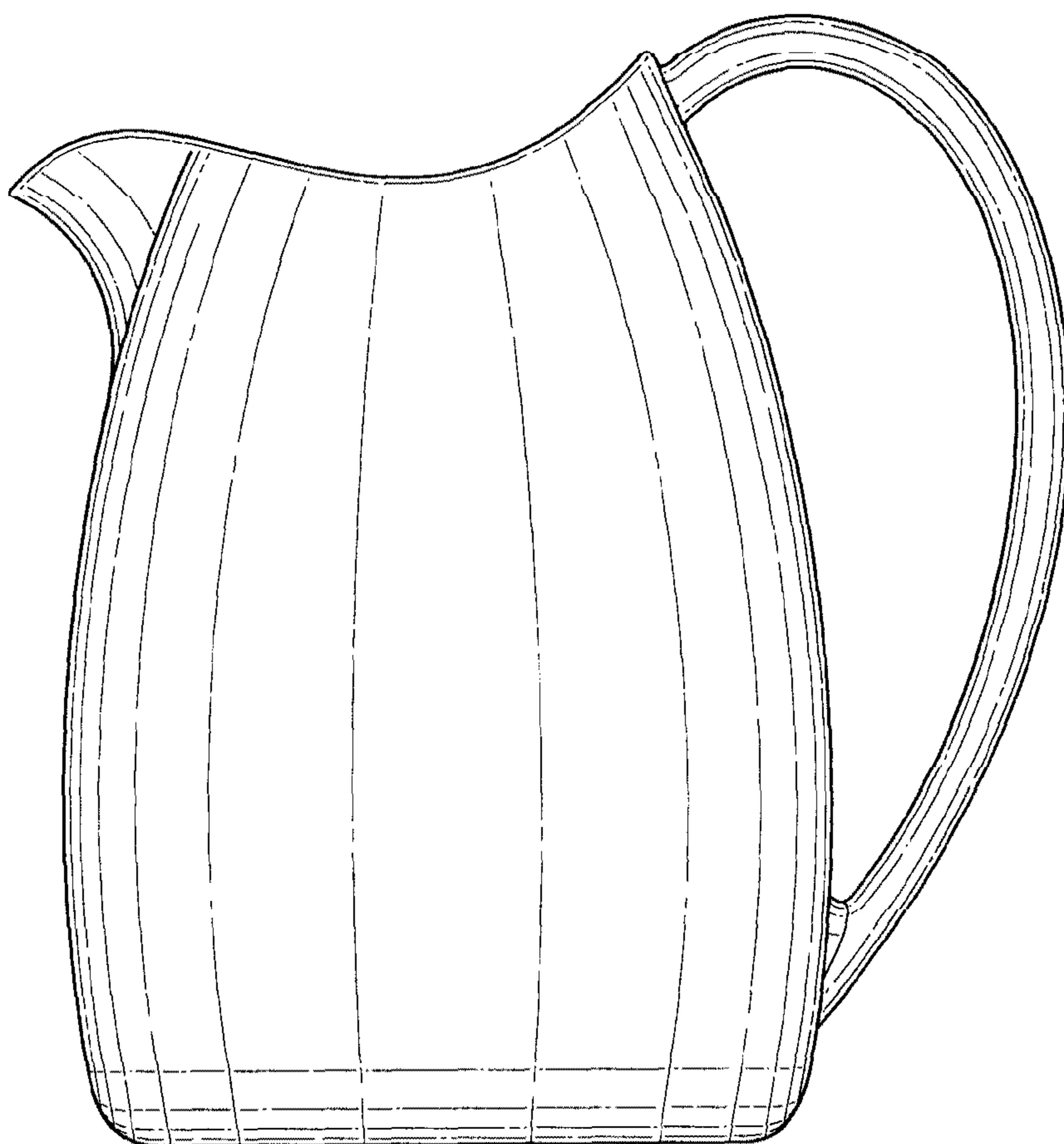

FIG. 9

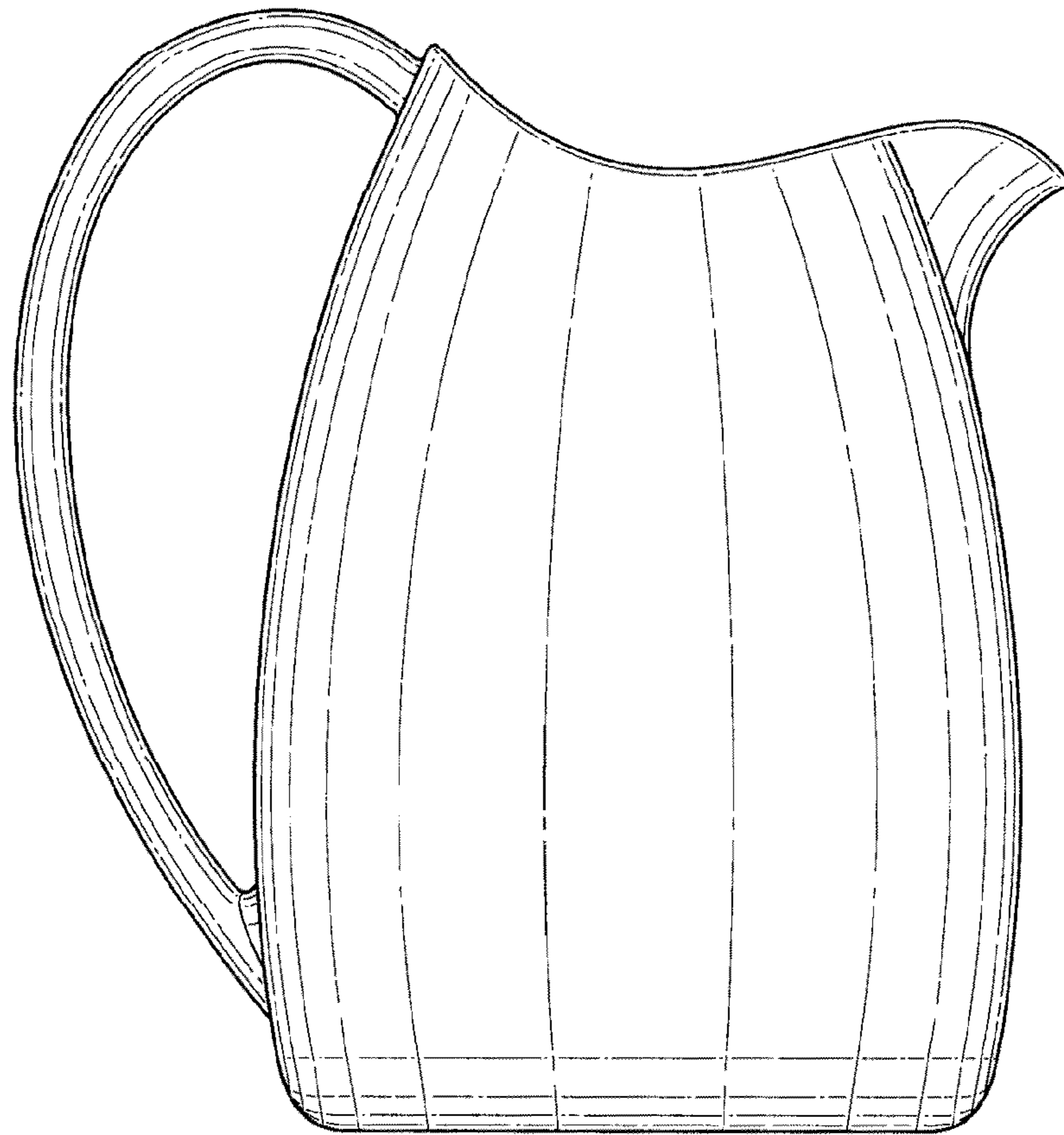

FIG. 10

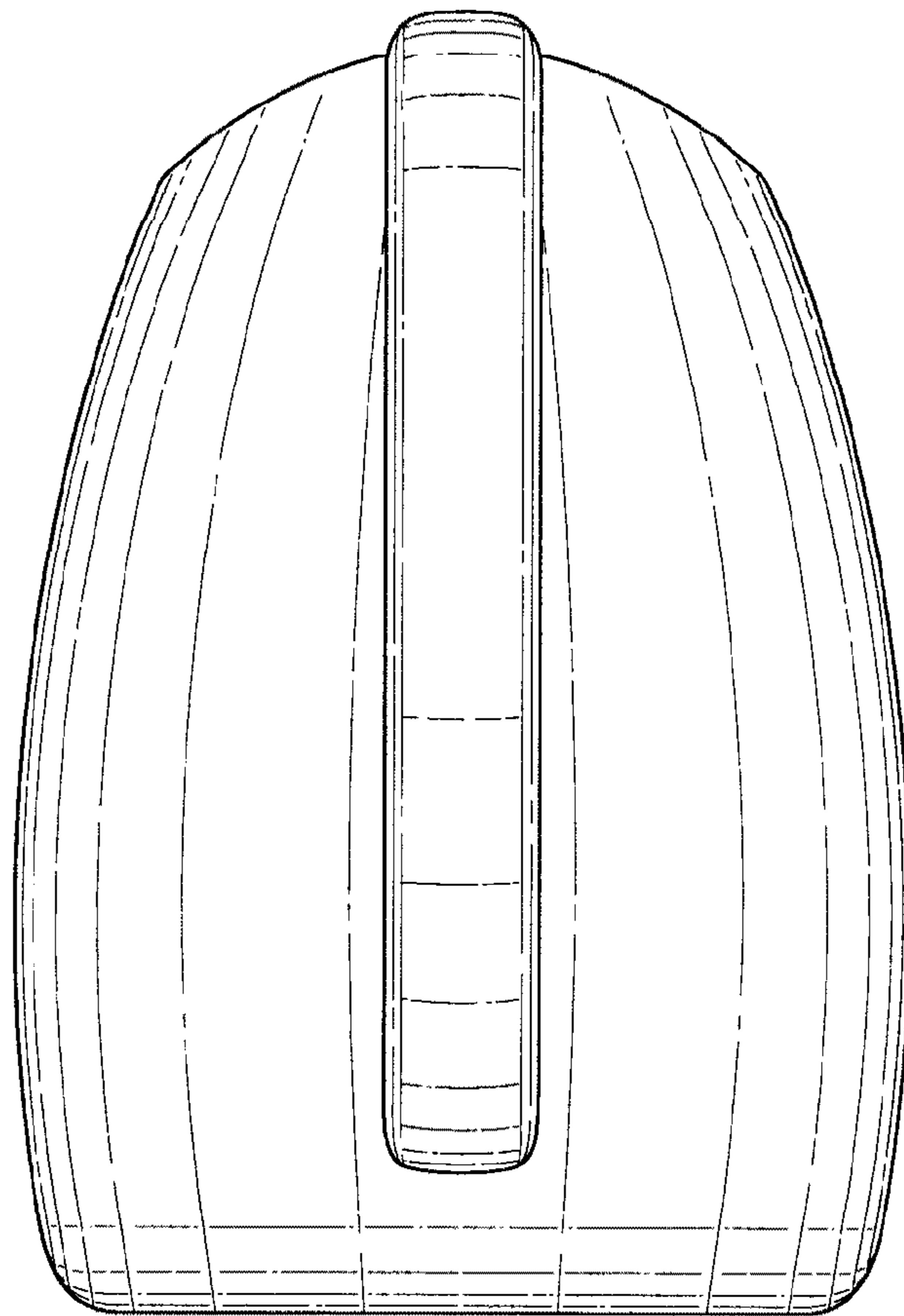

FIG.11

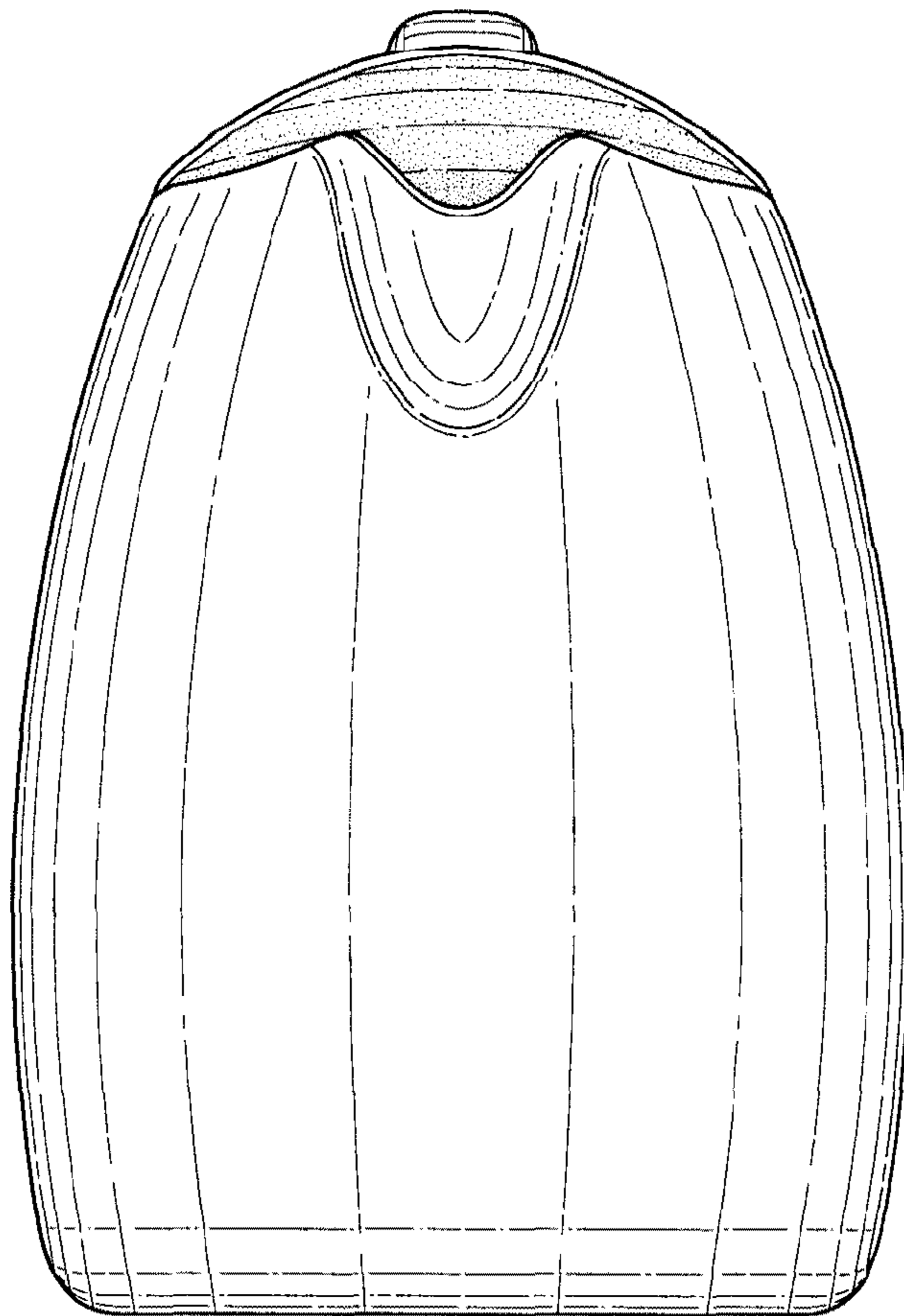

FIG.12

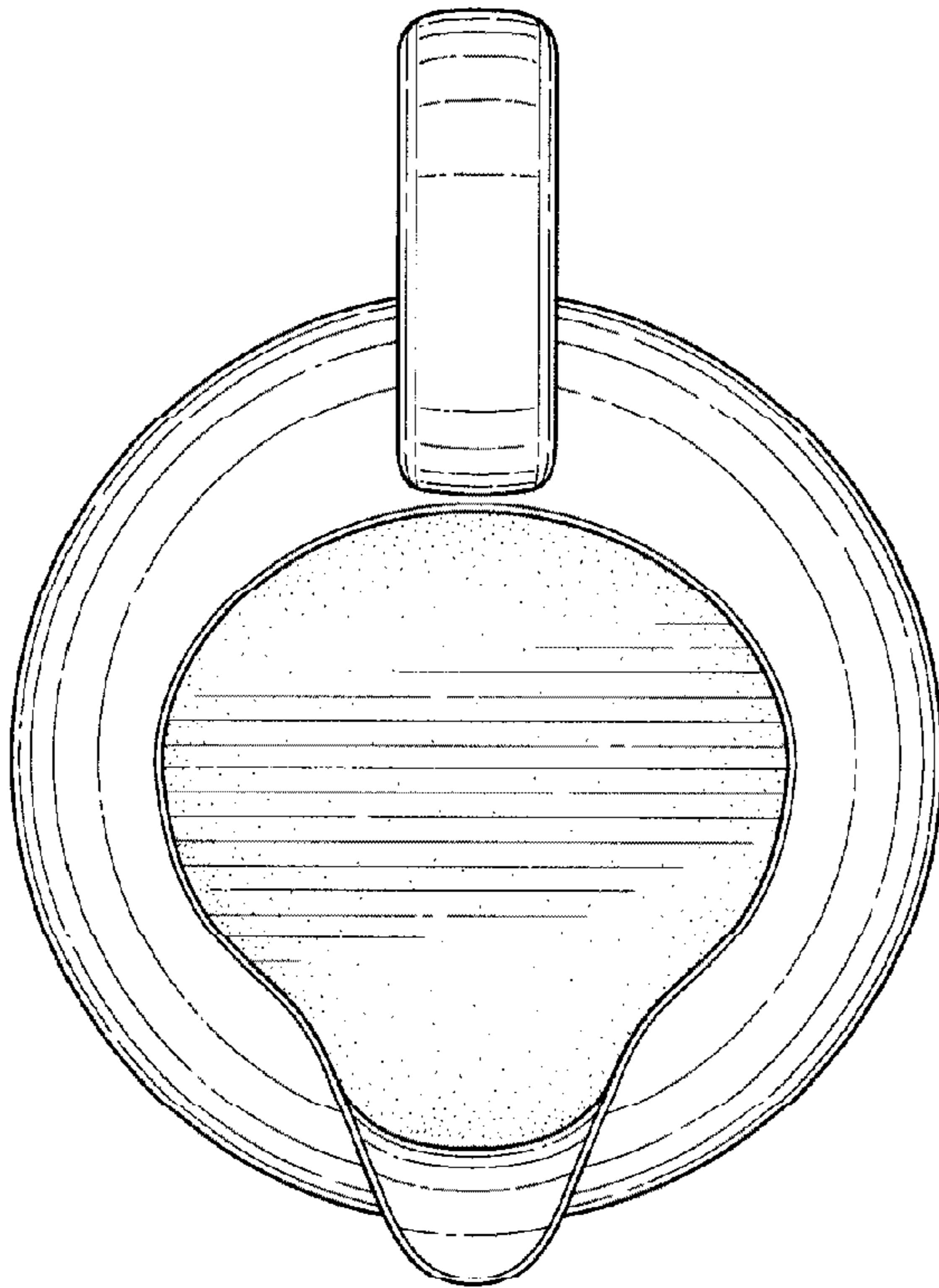

FIG.13

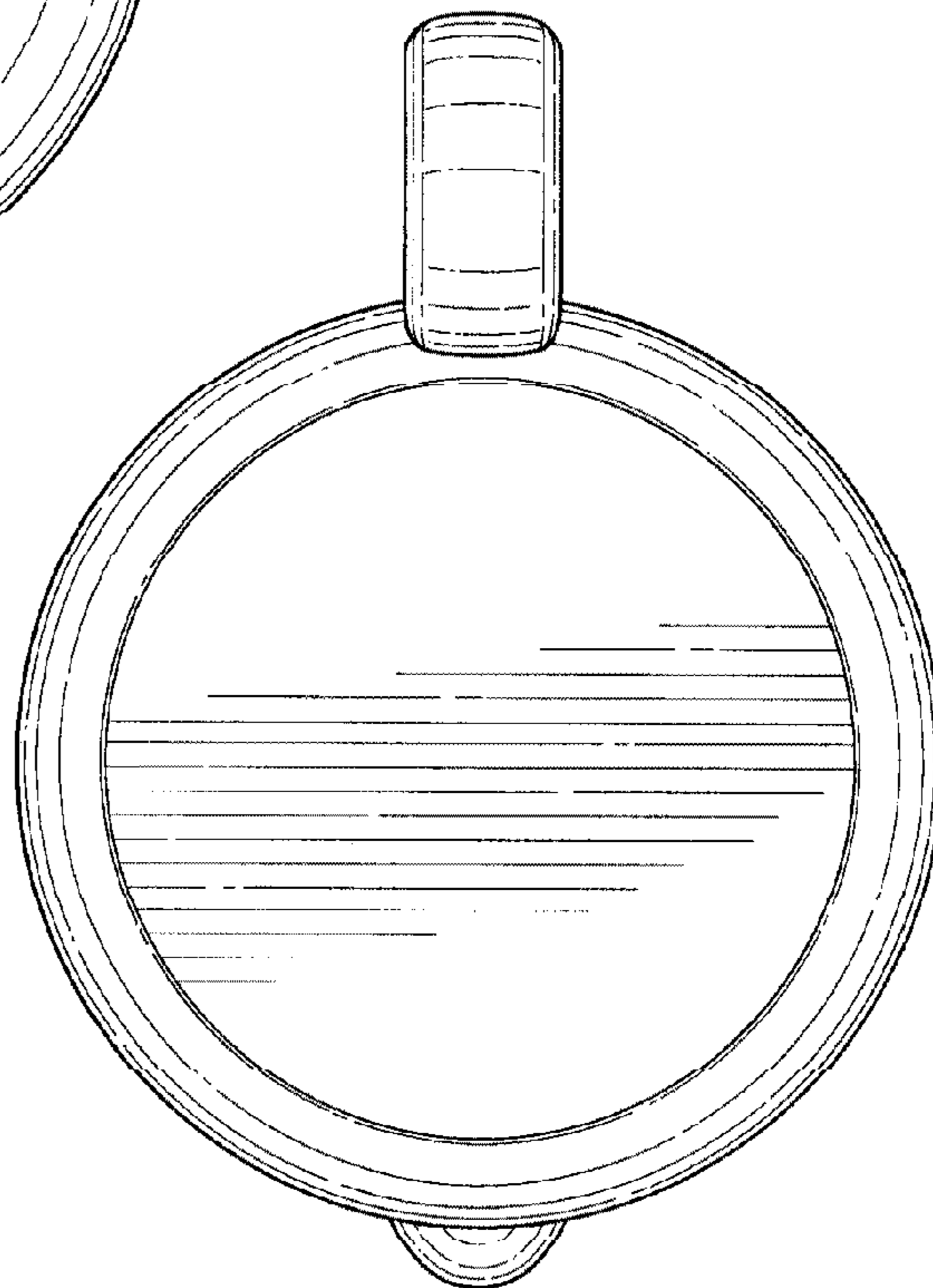

FIG.14

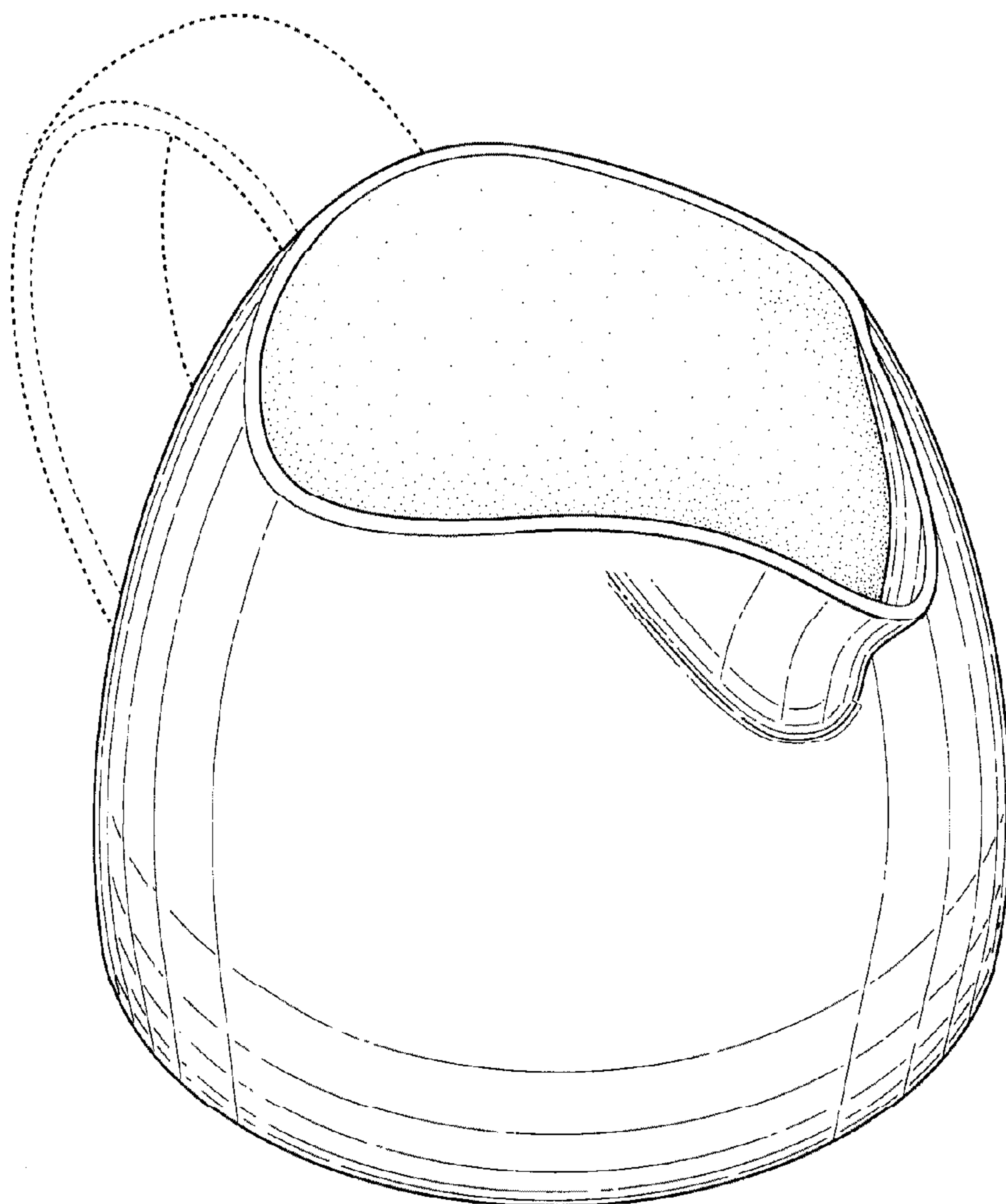

FIG. 15

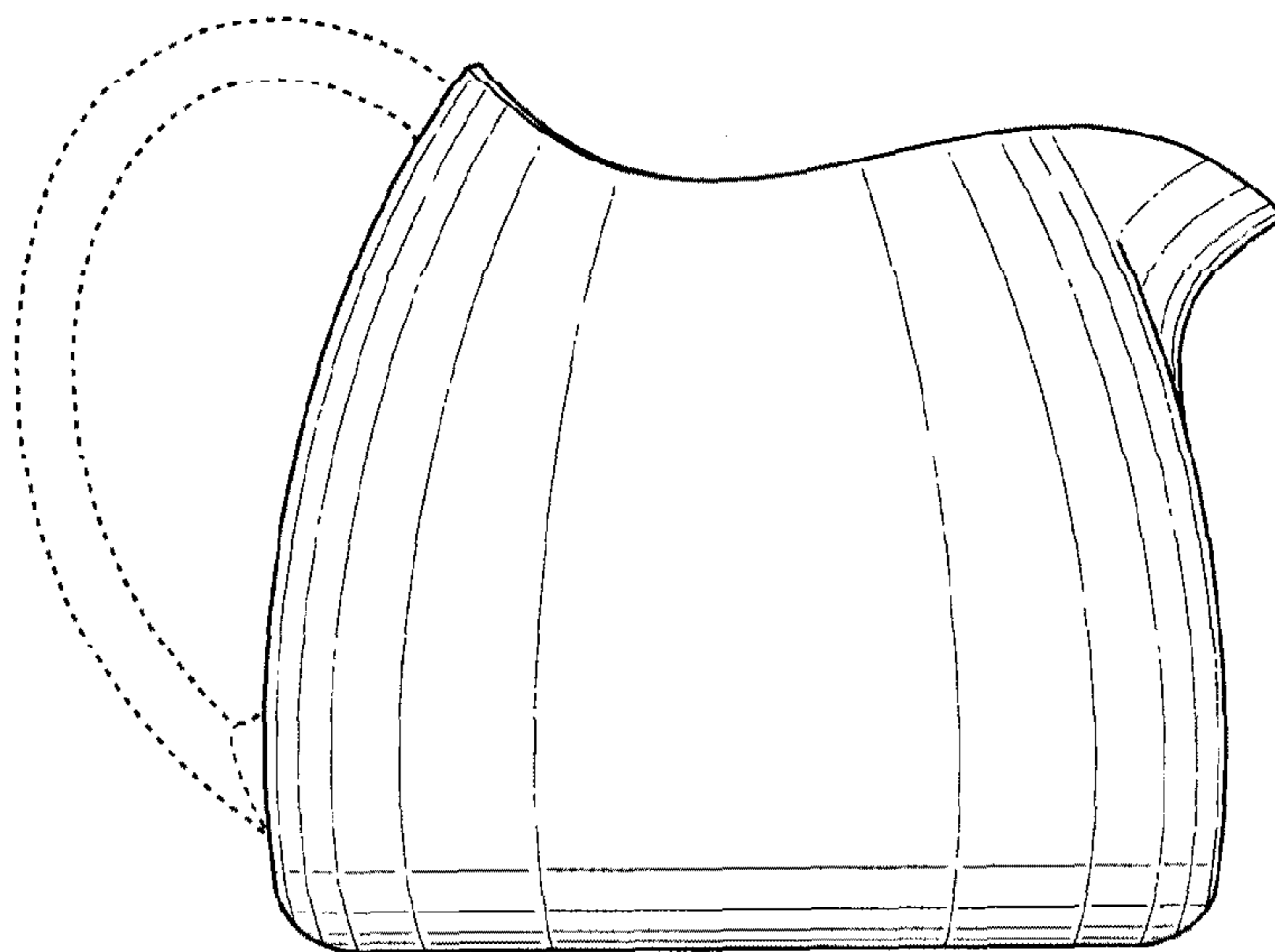

FIG. 16

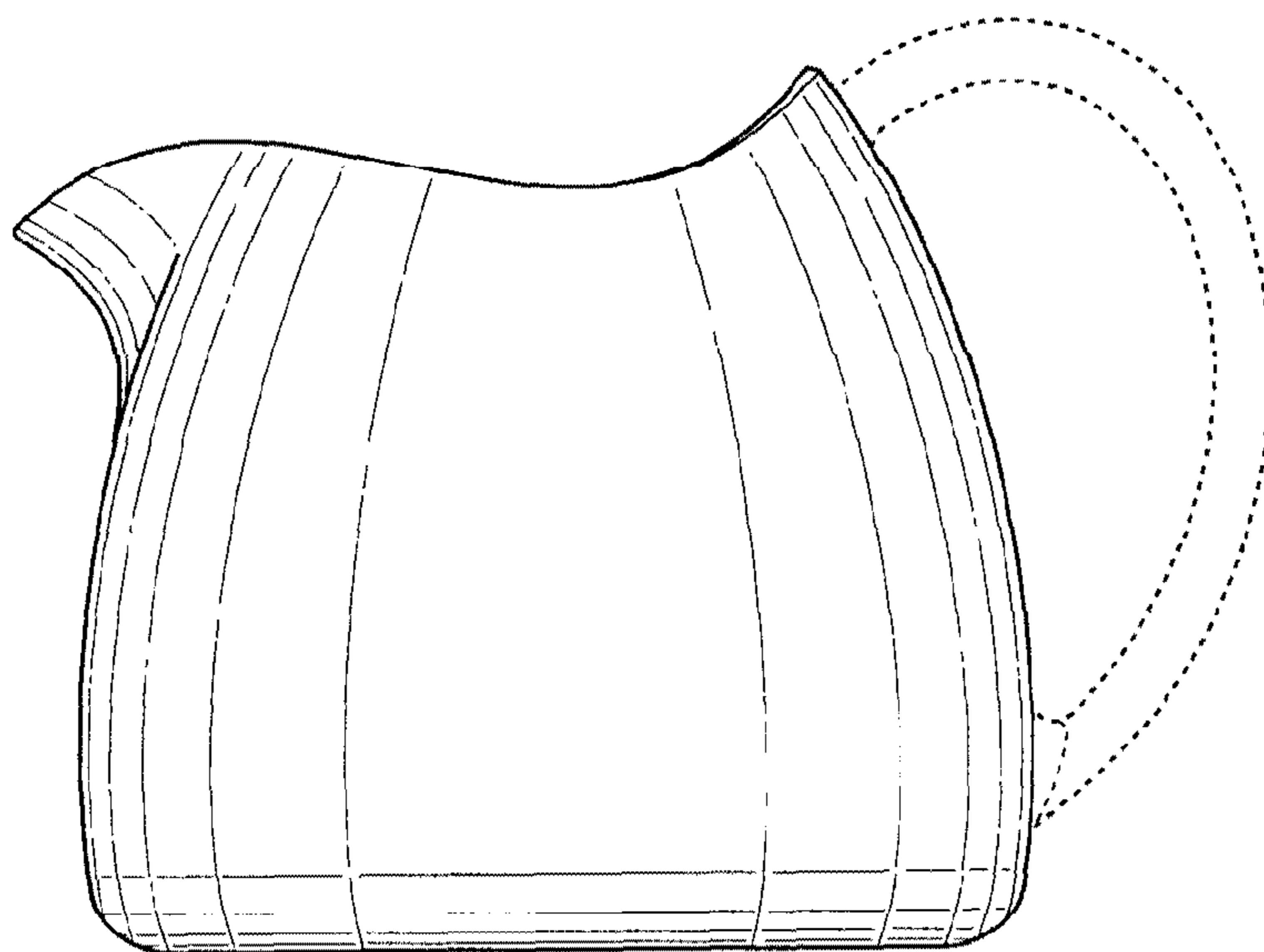

FIG. 17

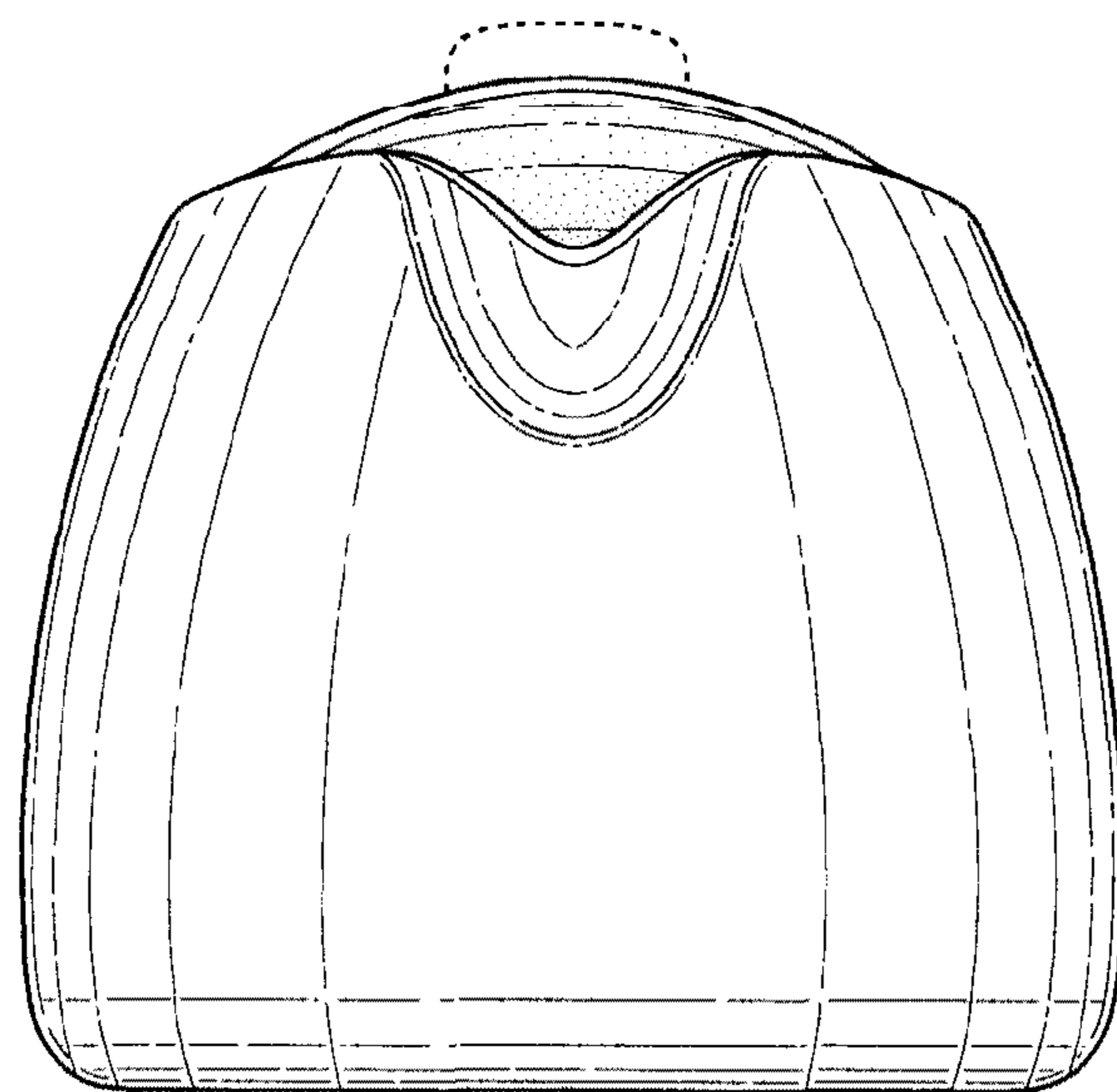

FIG. 18

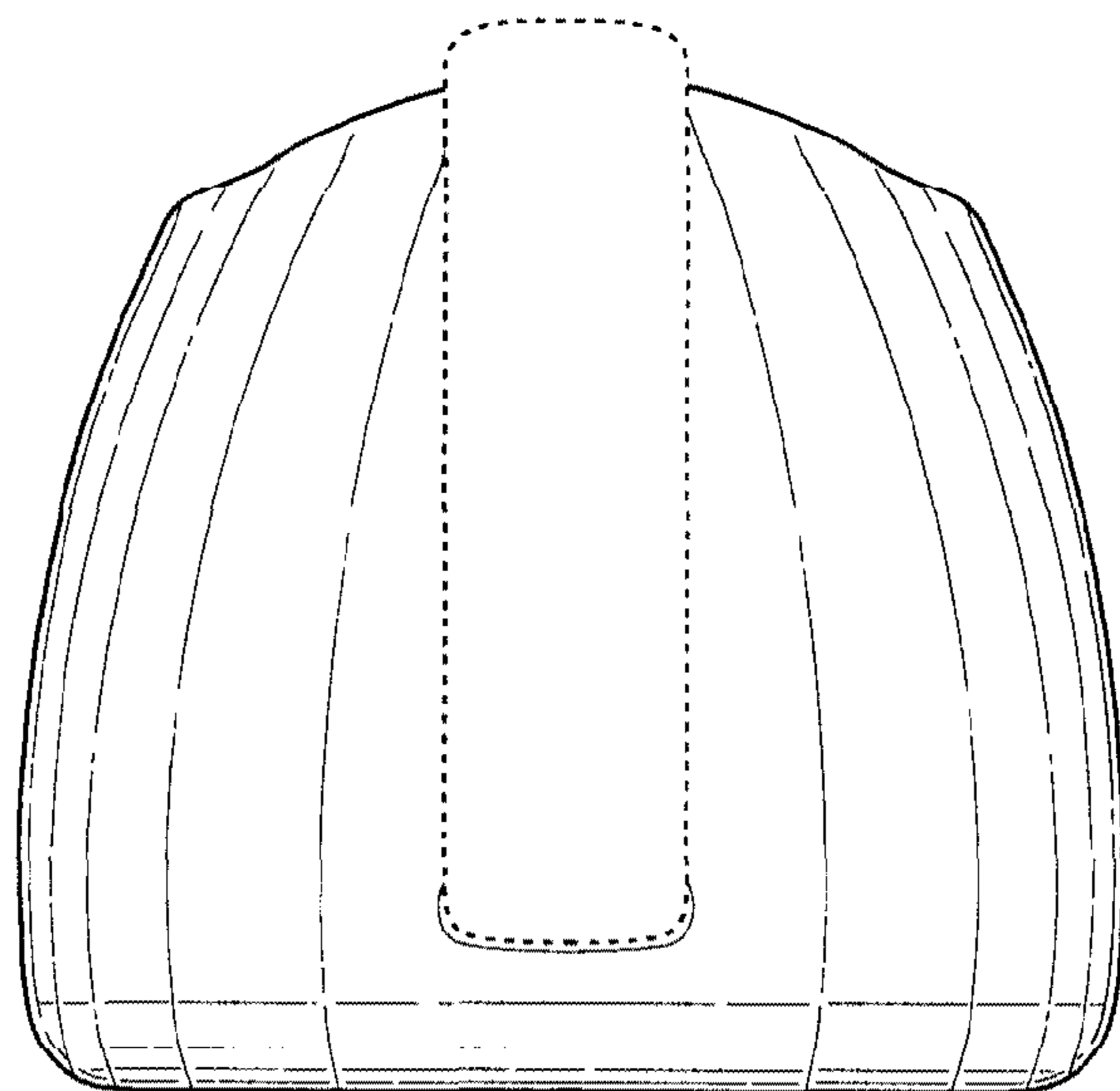

FIG. 19

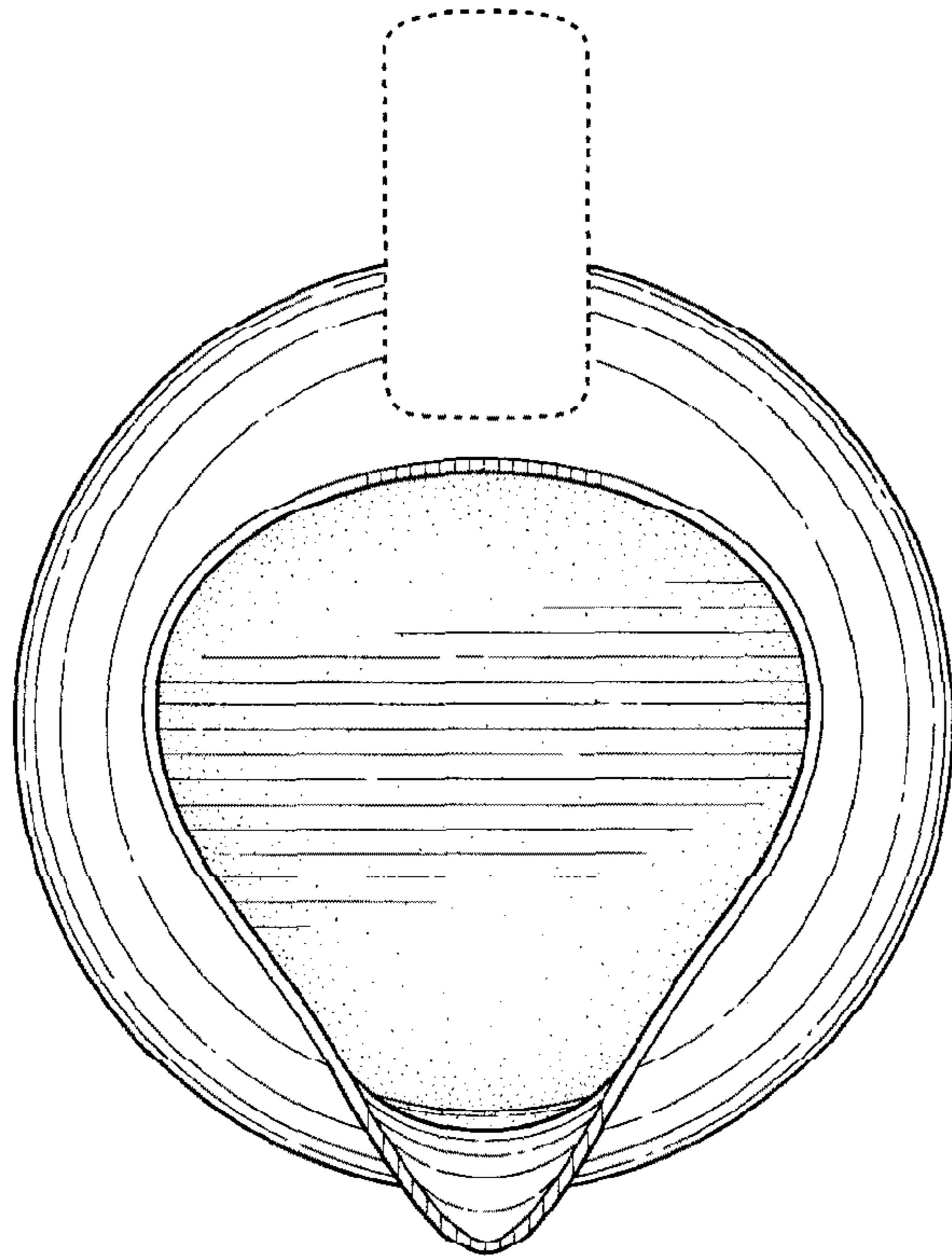

FIG. 20

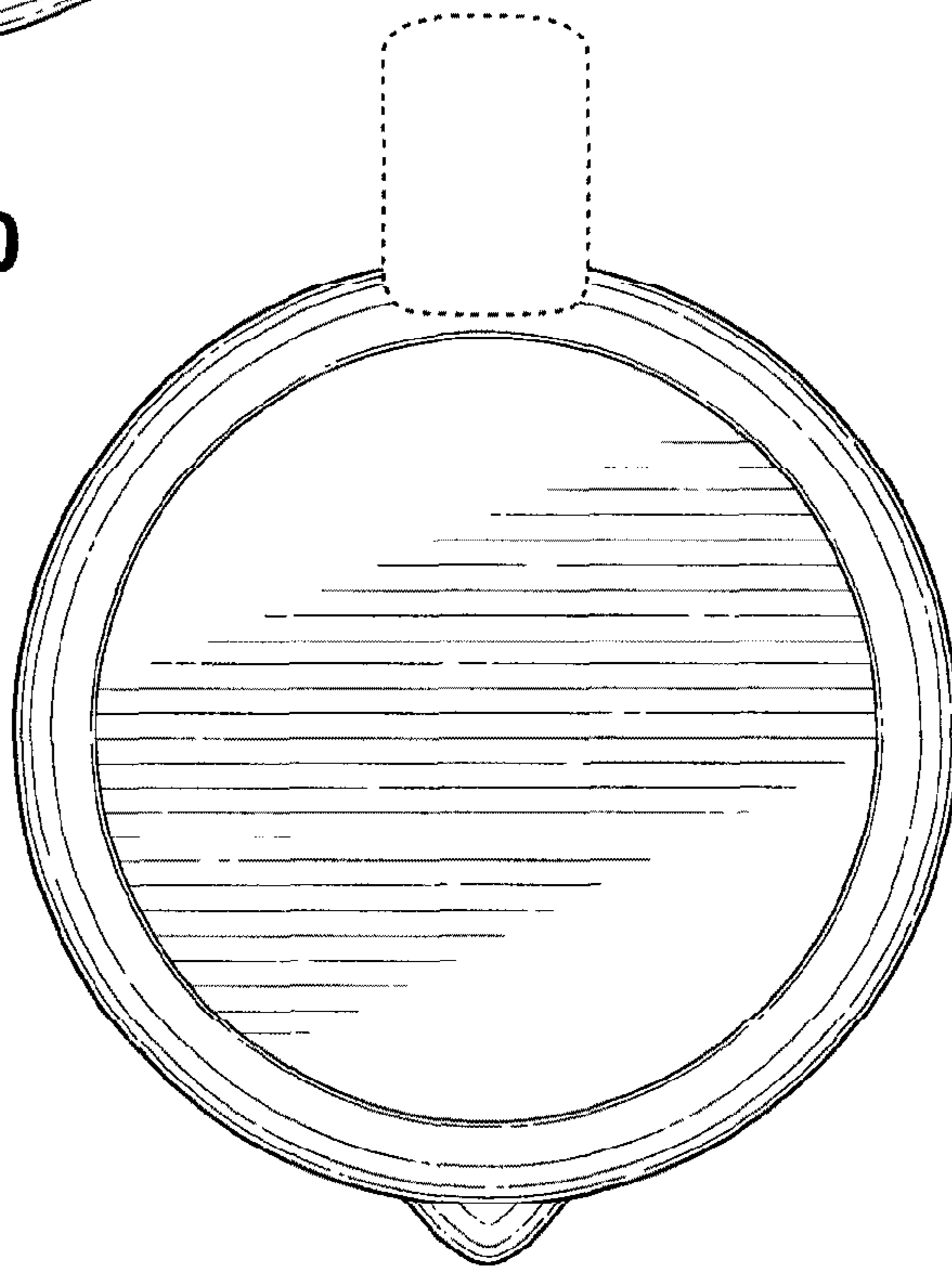

FIG. 21

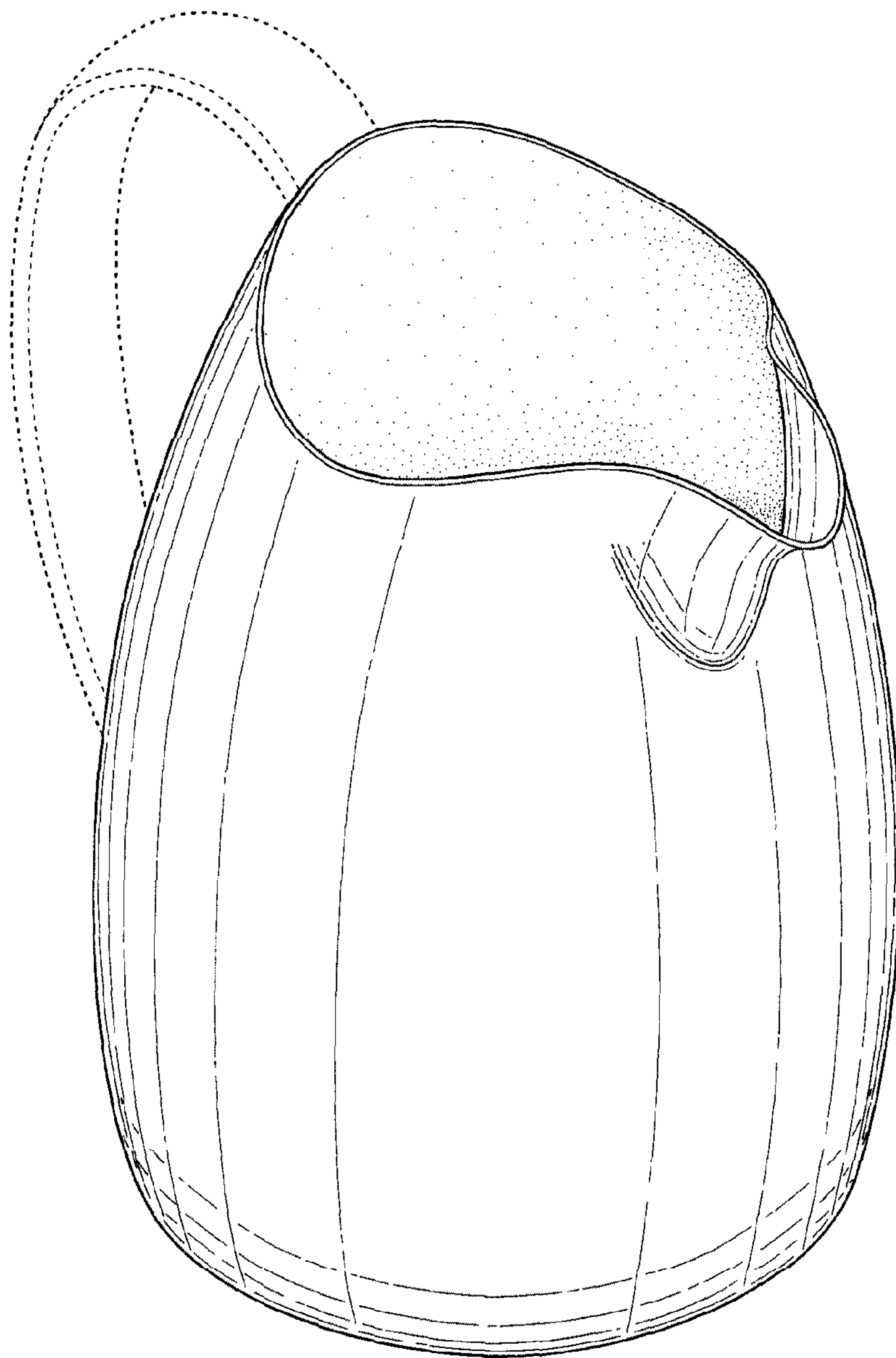

FIG. 22

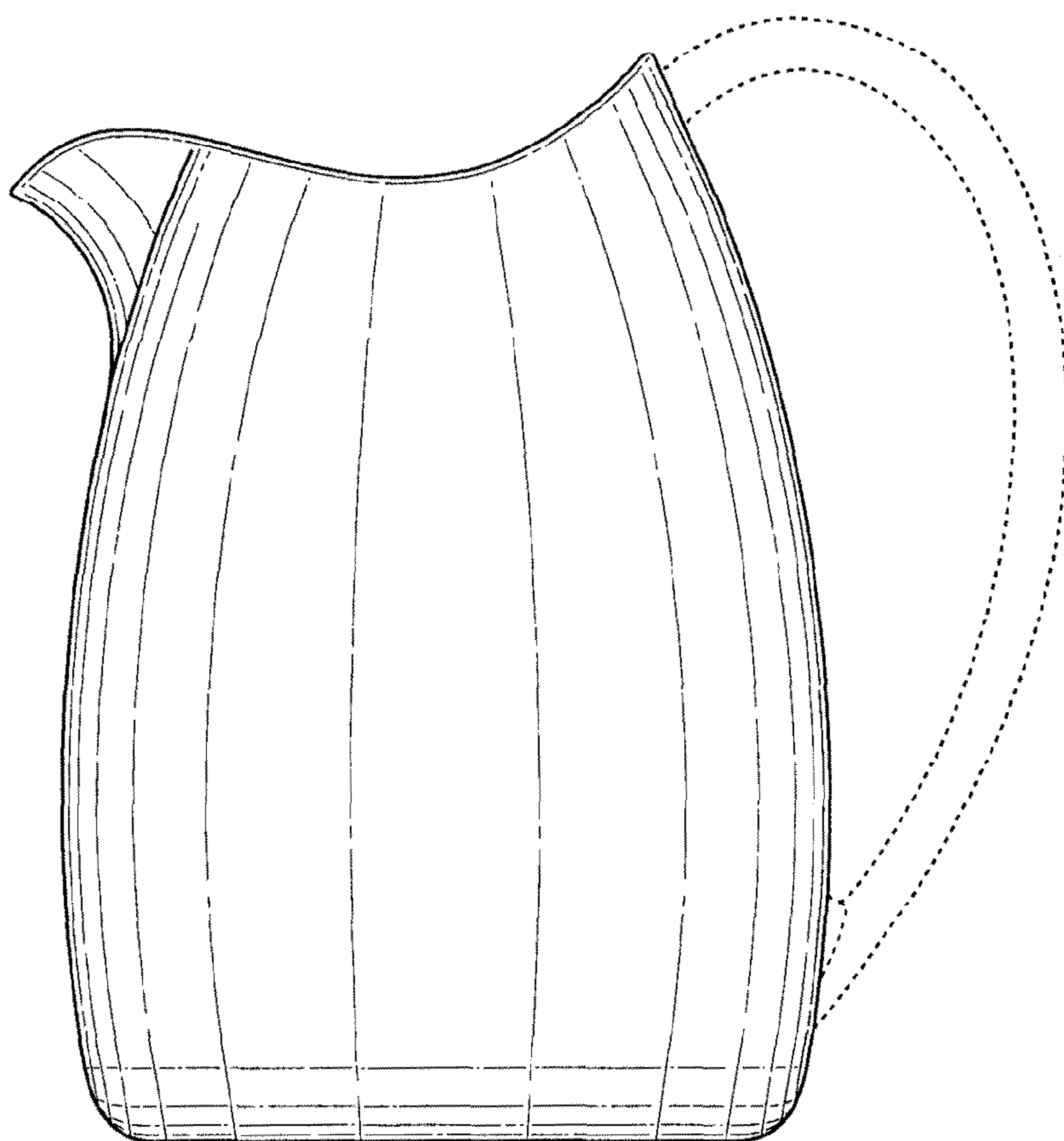

FIG. 23

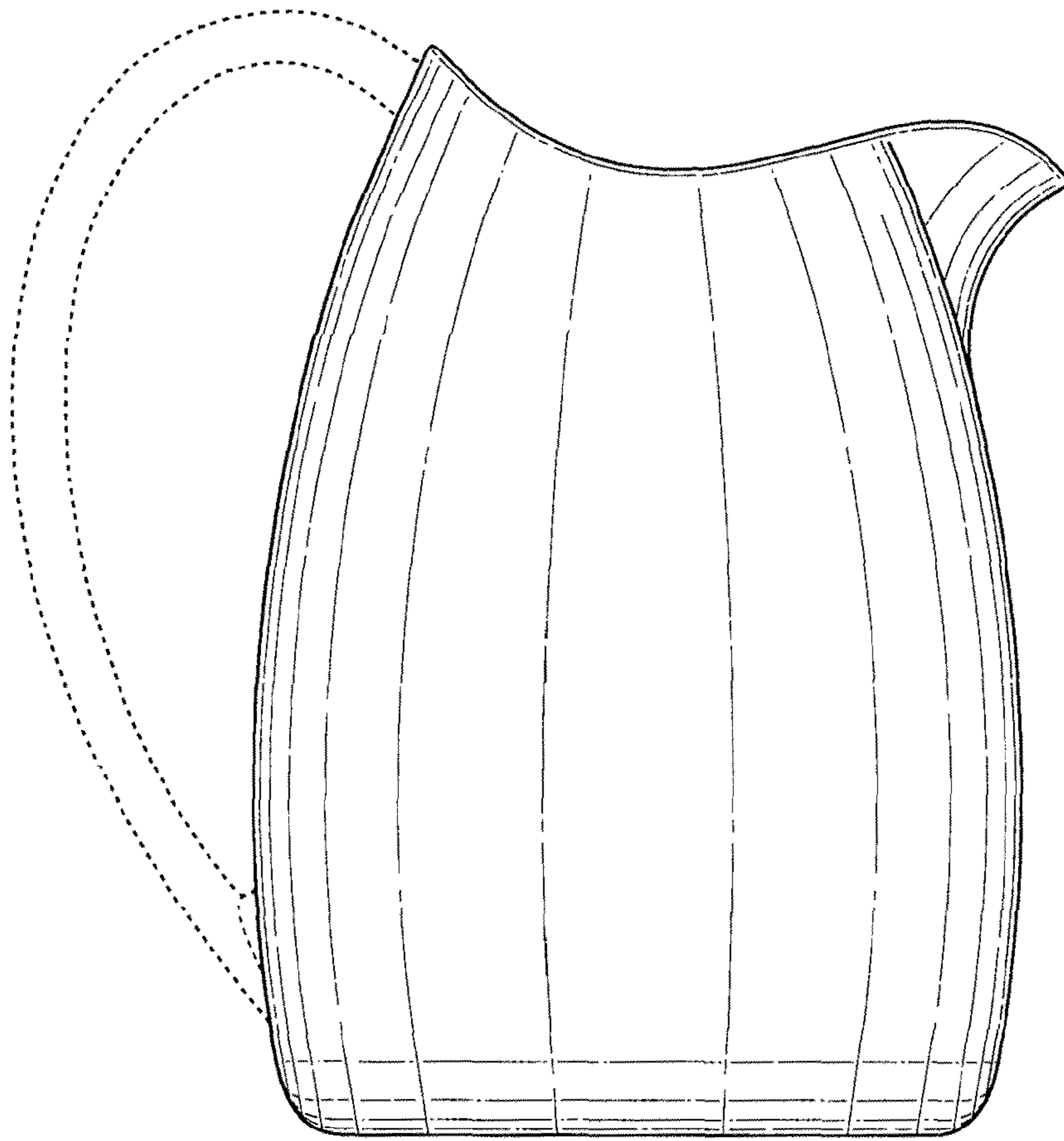

FIG. 24

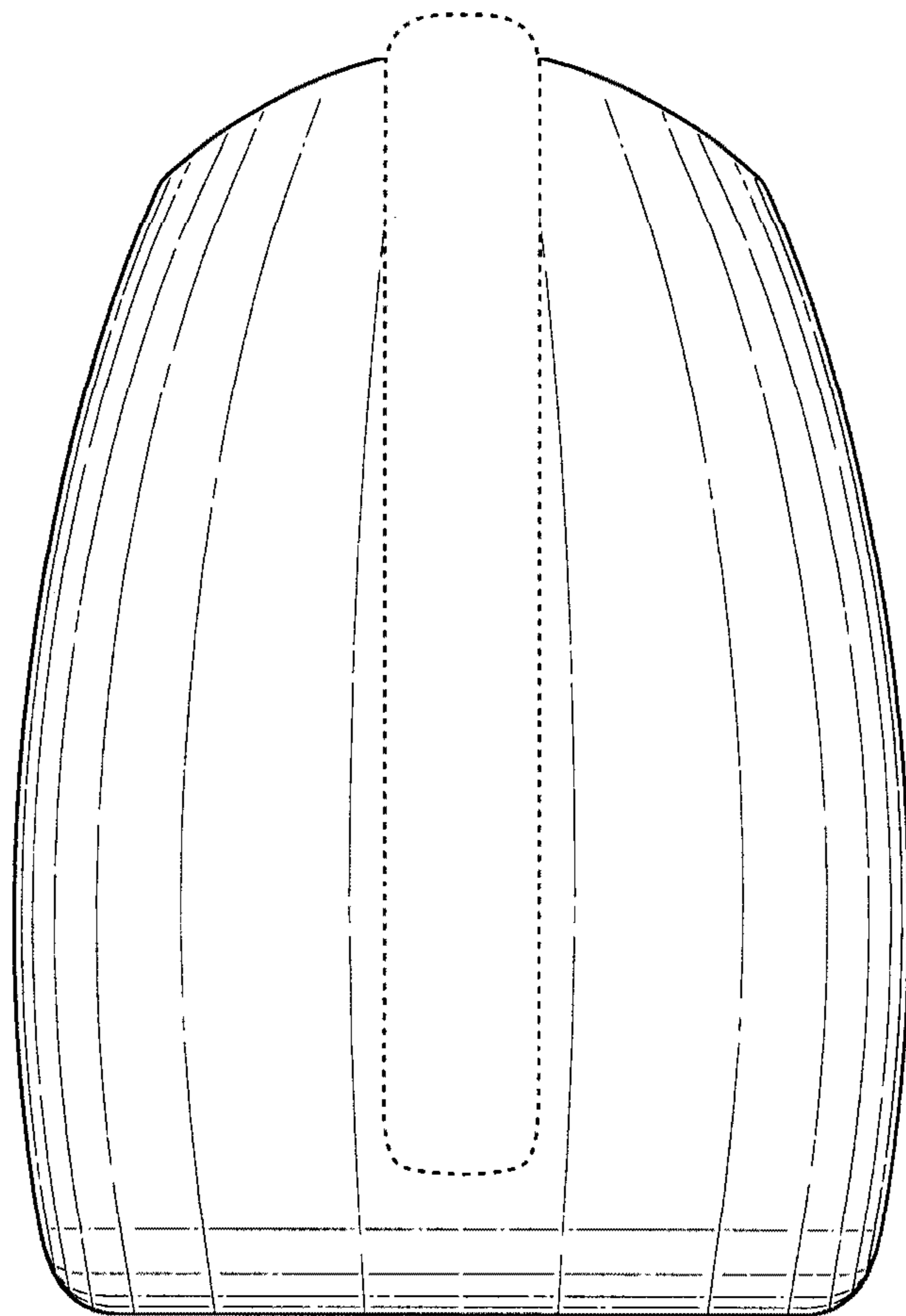

FIG. 25

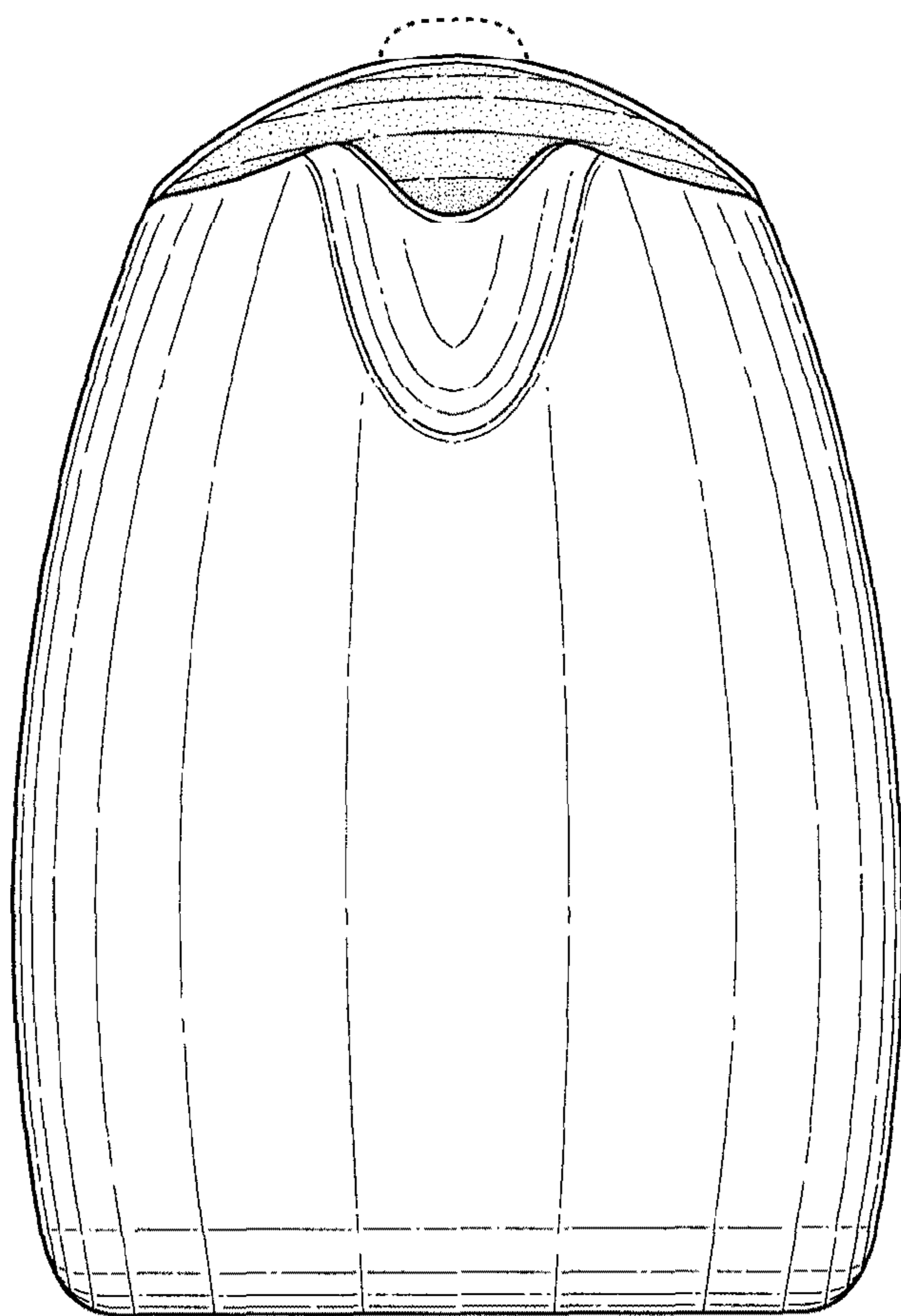

FIG. 26

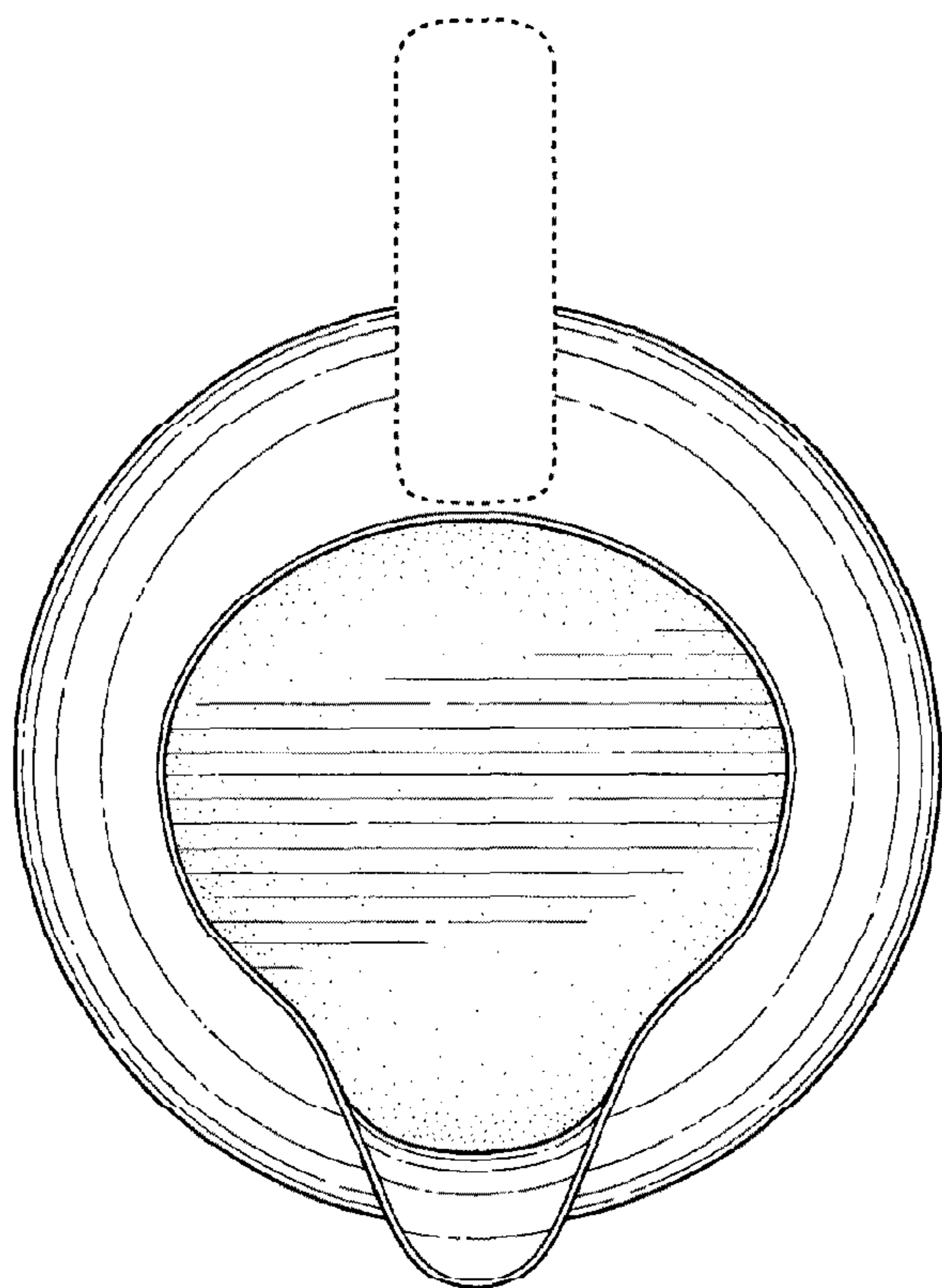

FIG. 27

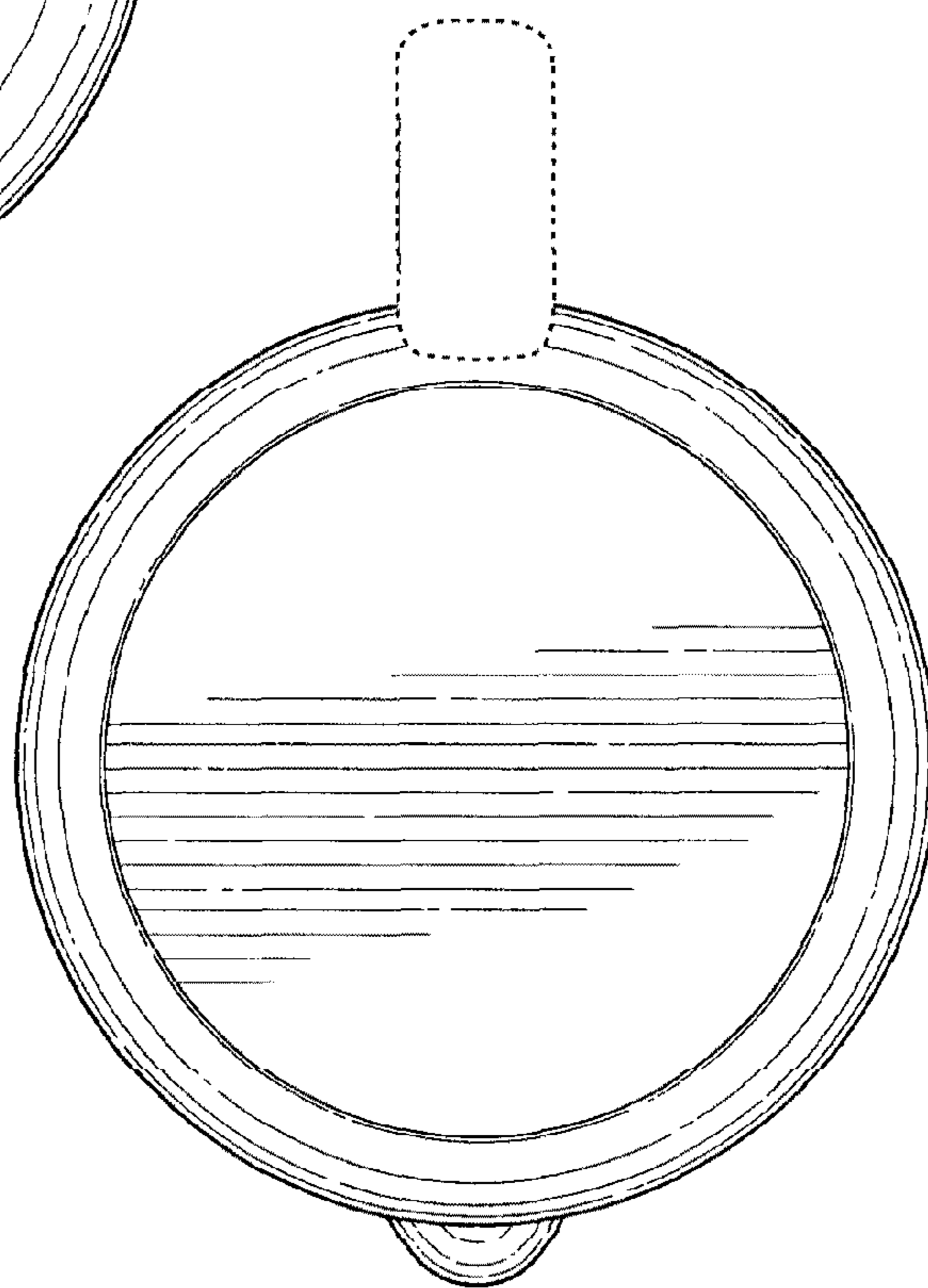

FIG. 28