



US00D722384S

(12) **United States Design Patent**
Kuneyl

(10) **Patent No.:** **US D722,384 S**

(45) **Date of Patent:** **** Feb. 10, 2015**

(54) **ORAL STIMULATION DEVICE**

(71) Applicant: **The Sensory University, LLC**, Buford, GA (US)

(72) Inventor: **Todd Kuneyl**, Cumming, GA (US)

(73) Assignee: **The Sensory University, LLC**, Buford, GA (US)

(**) Term: **14 Years**

(21) Appl. No.: **29/488,124**

(22) Filed: **Apr. 16, 2014**

(51) **LOC (10) Cl.** **28-03**

(52) **U.S. Cl.**
USPC **D24/214**

(58) **Field of Classification Search**
CPC A61H 16/30; A61H 19/32; A61H 19/34; A61H 19/40; A61H 19/44; A61H 19/50; A61H 19/00; A61H 2201/0153; A61H 2201/0207; A61H 2201/0263; A61H 2201/0111; A61H 2201/1253; A61H 2205/082; A61H 2205/085; A61H 15/0085
USPC D24/200, 211, 212, 213, 214, 215; 601/114, 120, 121, 124, 125, 130, 131, 601/134, 135, 136, 137

See application file for complete search history.

(56) **References Cited**

U.S. PATENT DOCUMENTS

D396,296 S *	7/1998	Breznik	D24/211
D590,510 S *	4/2009	Johansen et al.	D24/214
D639,444 S *	6/2011	A	D24/214
D675,332 S *	1/2013	Tinder	D24/215

* cited by examiner

Primary Examiner — Sandra Snapp

(74) *Attorney, Agent, or Firm* — Meunier Carlin & Curfman LLC

(57) **CLAIM**

The ornamental design for an oral stimulation device, as shown and described.

DESCRIPTION

FIG. 1 is a perspective view of an oral stimulation device. FIG. 2 is a top plan view of the embodiment depicted in FIG. 1. FIG. 3 is a bottom plan view of the embodiment depicted in FIG. 1. FIG. 4 is a side elevational view of the embodiment depicted in FIG. 1. FIG. 5 is a side elevational view of the embodiment depicted in FIG. 1. FIG. 6 is a right side elevation view of the embodiment depicted in FIG. 1; and, FIG. 7 is a left side elevation view of the embodiment depicted in FIG. 1.

1 Claim, 7 Drawing Sheets

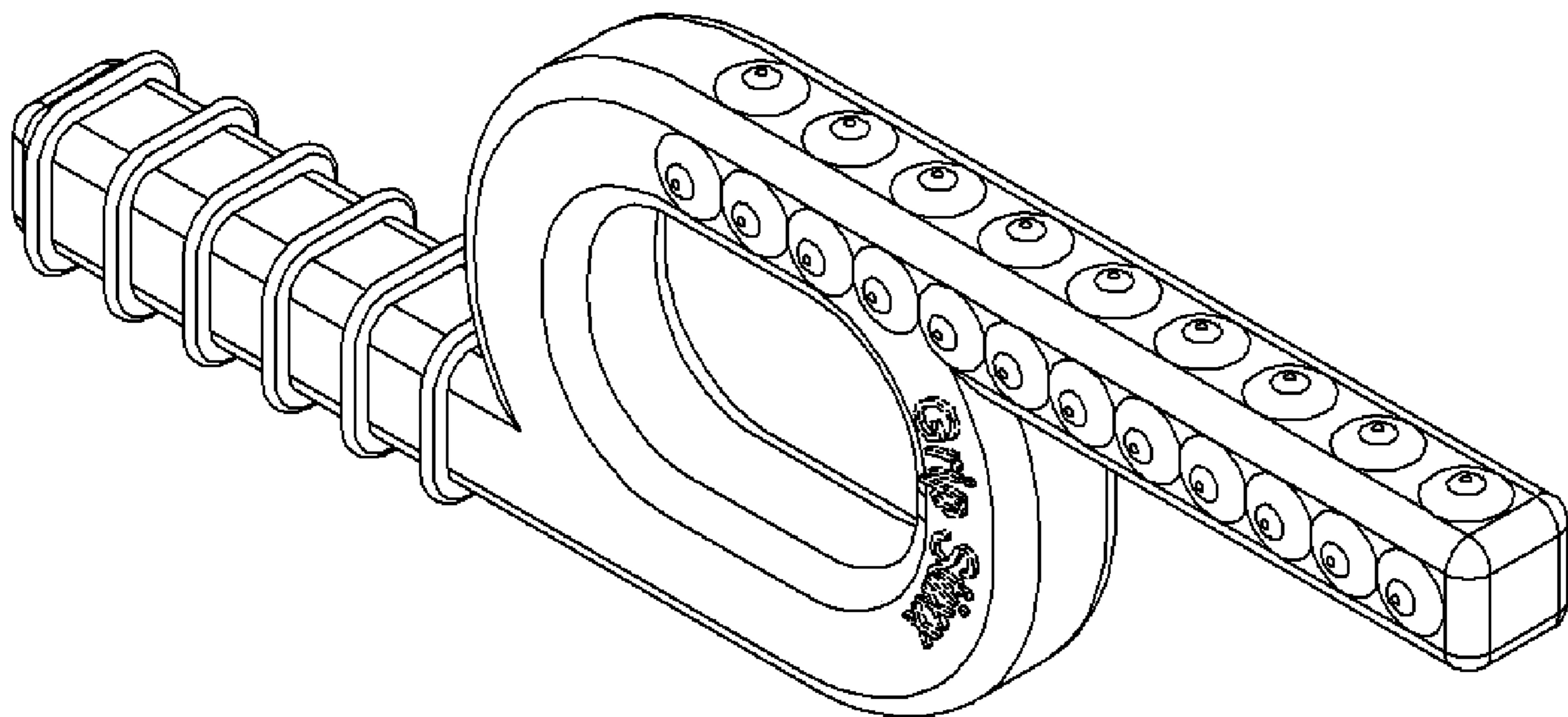

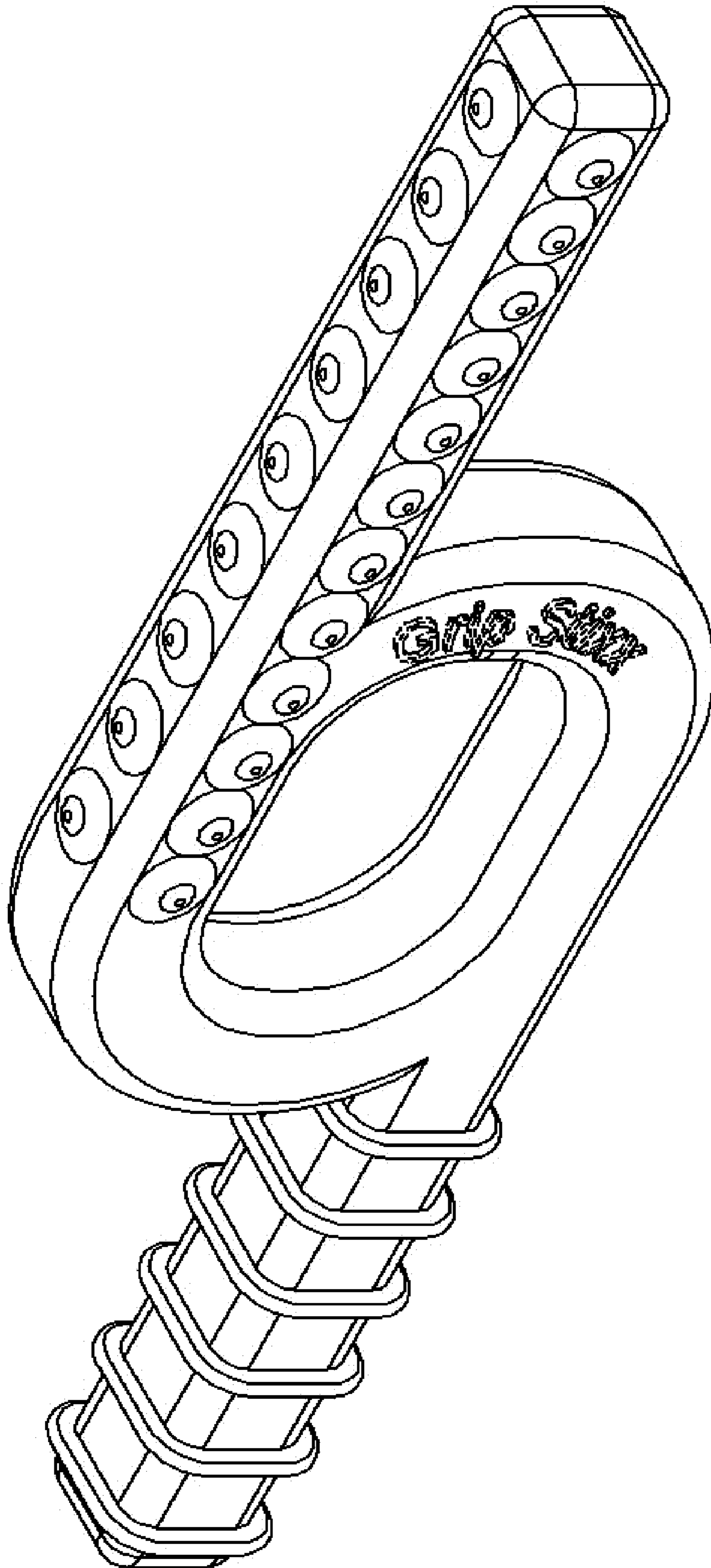

FIG. 1

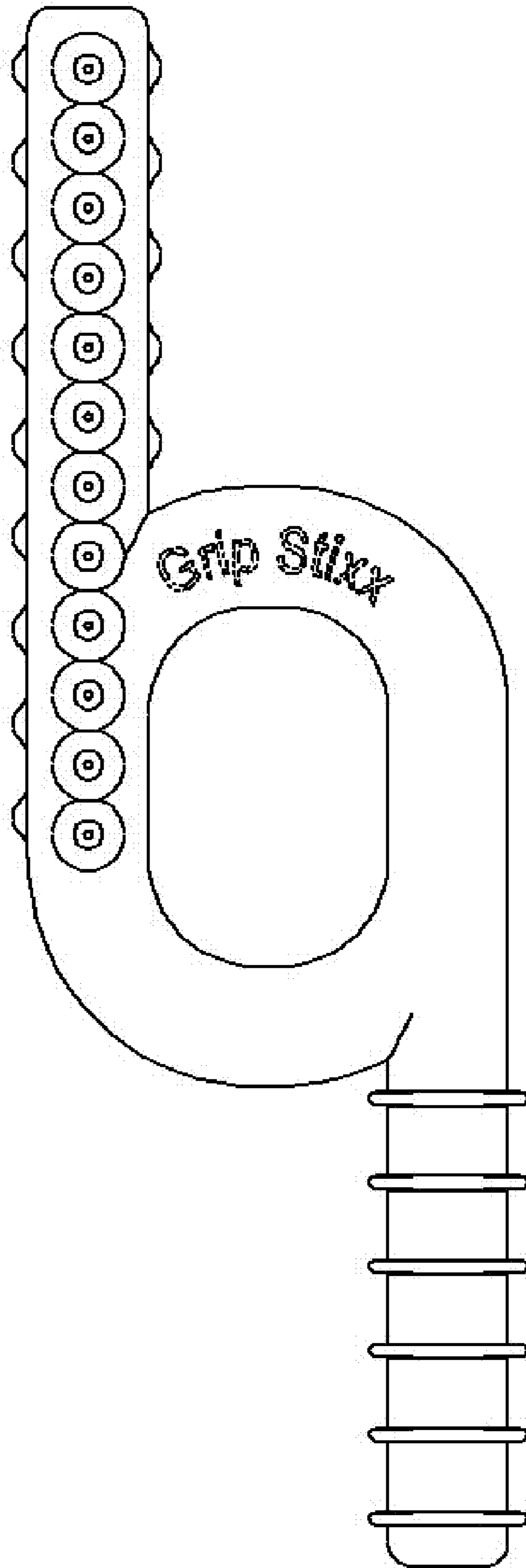

FIG. 2

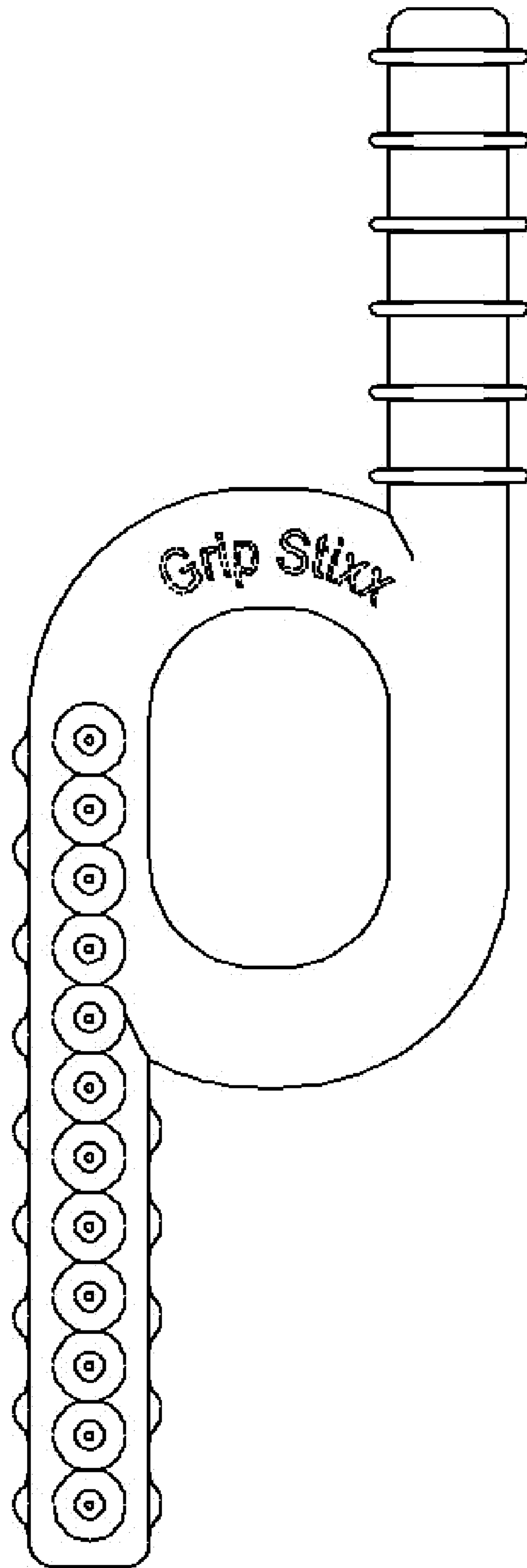

FIG. 3

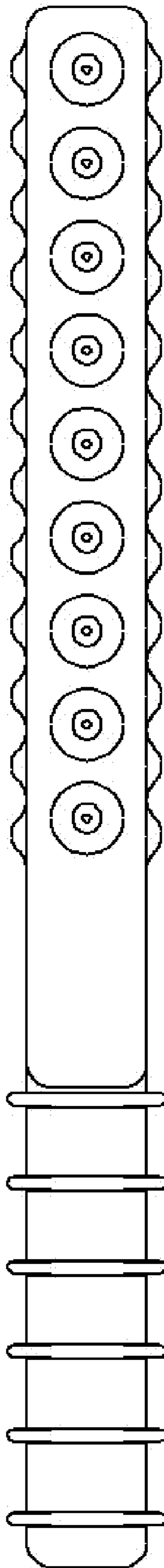

FIG. 4

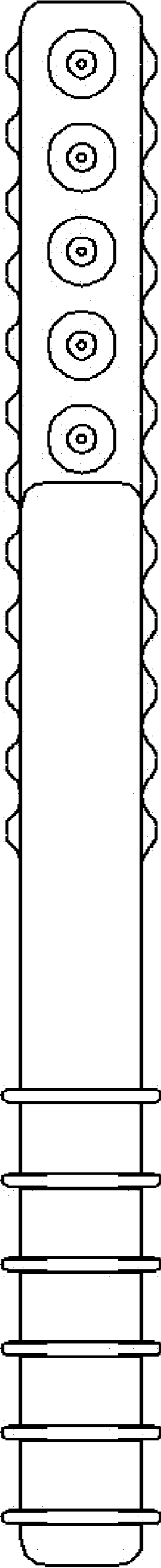

FIG. 5

FIG. 6

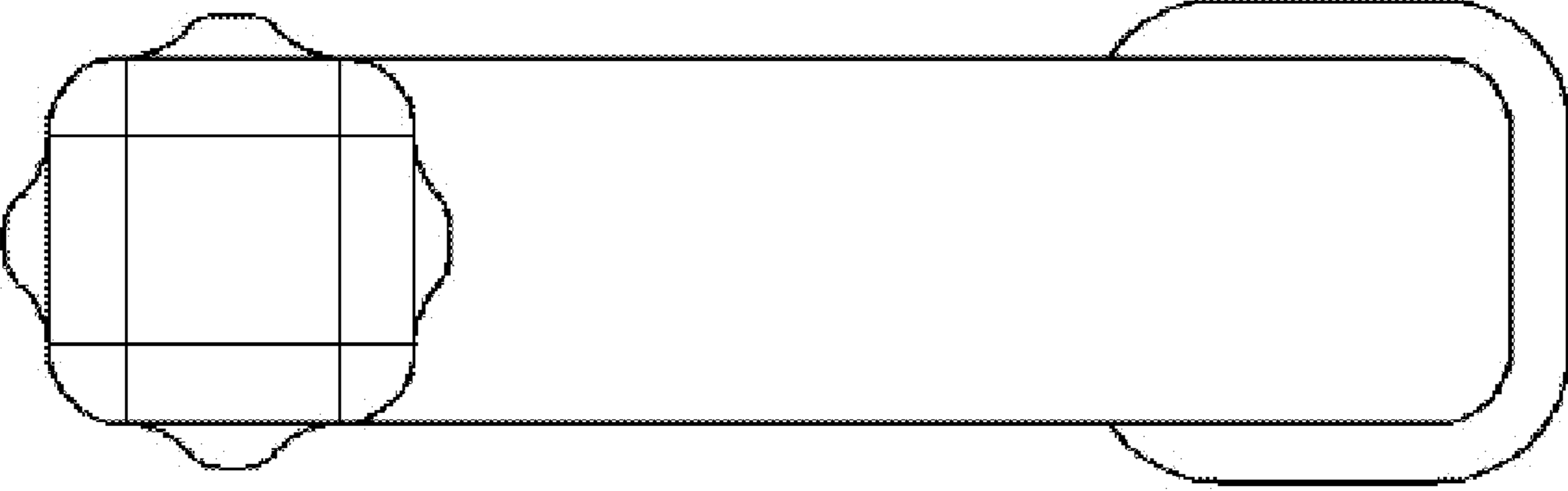

FIG. 7

