

US00D722351S

(12) **United States Design Patent**  
**Parsons et al.**

(10) **Patent No.:** **US D722,351 S**  
(45) **Date of Patent:** **\*\* Feb. 10, 2015**

- (54) **GOLF CLUB HEAD**
- (71) Applicant: **Slick Golf, LLC**, Scottsdale, AZ (US)
- (72) Inventors: **Robert R. Parsons**, Scottsdale, AZ (US); **Bradley D. Schweigert**, Anthem, AZ (US); **Michael R. Nicolette**, Scottsdale, AZ (US)
- (73) Assignee: **Parsons Xtreme Golf, LLC**, Scottsdale, AZ (US)
- (\*\*) Term: **14 Years**
- (21) Appl. No.: **29/501,012**
- (22) Filed: **Aug. 29, 2014**
- (51) **LOC (10) Cl.** ..... **21-02**
- (52) **U.S. Cl.**  
USPC ..... **D21/736**
- (58) **Field of Classification Search**  
USPC ..... D21/736-746, 759; 473/324-331,  
473/340-341, 251-256  
See application file for complete search history.

- D436,151 S 1/2001 Nicolette et al.
- D441,820 S 5/2001 Nicolette et al.
- D443,668 S 6/2001 Nicolette et al.

(Continued)

*Primary Examiner* — Mitchell Siegel

(57) **CLAIM**  
The ornamental design for a golf club head, as shown and described.

**DESCRIPTION**

FIG. 1 is a top perspective view of a golf club head;  
 FIG. 2 is a bottom perspective view of the golf club head of FIG. 1;  
 FIG. 3 is a front elevational view of the golf club head of FIG. 1;  
 FIG. 4 is a rear elevational view of the golf club head of FIG. 1;  
 FIG. 5 is a top view of the golf club head of FIG. 1;  
 FIG. 6 is a bottom view of the golf club head of FIG. 1;  
 FIG. 7 is a right side view of the golf club head of FIG. 1;  
 FIG. 8 is a left side view of the golf club head of FIG. 1;  
 FIG. 9 is top perspective view of another golf club head;  
 FIG. 10 is a bottom perspective view of the golf club head of FIG. 9;  
 FIG. 11 is a front elevational view of the golf club head of FIG. 9;  
 FIG. 12 is a rear elevational view of the golf club head of FIG. 9;  
 FIG. 13 is a top view of the golf club head of FIG. 9;  
 FIG. 14 is a bottom view of the golf club head of FIG. 9;  
 FIG. 15 is a right side view of the golf club head of FIG. 9;  
 and,  
 FIG. 16 is a left side view of the golf club head of FIG. 9.  
 The broken lines connecting the solid lines represent the bounds of the claim. The remaining broken lines illustrate the environment. None of the broken lines forms part of the claimed design.

(56) **References Cited**

U.S. PATENT DOCUMENTS

- 5,489,097 A 2/1996 Simmons
- D368,751 S \* 4/1996 Rife ..... D21/745
- D369,393 S \* 4/1996 Takahashi et al. .... D21/745
- D378,688 S 4/1997 Cameron
- 5,683,307 A 11/1997 Rife
- D388,143 S \* 12/1997 Huan-Chiang ..... D21/745
- D398,685 S 9/1998 Masuda
- D399,290 S \* 10/1998 Sizemore, Jr. .... D21/742
- D399,911 S 10/1998 Nicolette et al.
- D405,836 S 2/1999 Nicolette et al.
- 5,924,938 A 7/1999 Hines

**1 Claim, 8 Drawing Sheets**

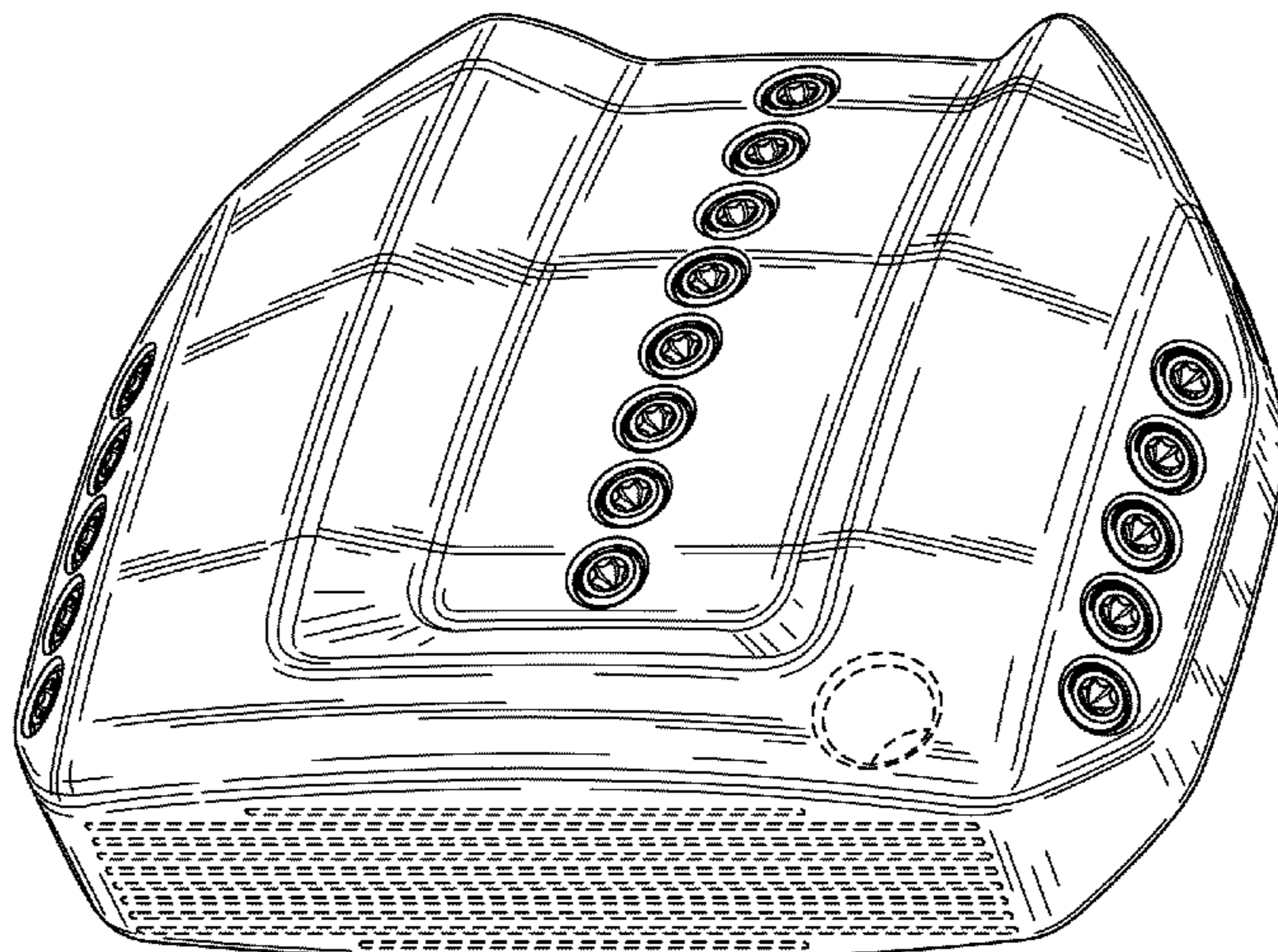

(56)

References Cited

U.S. PATENT DOCUMENTS

D443,905 S	6/2001	Nicolette et al.	D579,506 S	10/2008	Nicolette et al.
D444,833 S	7/2001	Wells et al.	D579,995 S	11/2008	Nicolette et al.
D449,664 S	10/2001	Beebe et al.	D582,497 S	12/2008	Rollinson
D449,865 S	10/2001	Fife et al.	7,473,189 B2	1/2009	Schweigert et al.
D450,799 S	11/2001	Nicolette et al.	7,491,131 B2	2/2009	Vinton
D451,973 S	12/2001	Wells et al.	D599,425 S	9/2009	Laub
6,348,014 B1	2/2002	Chiu	7,744,485 B2	6/2010	Jones et al.
6,354,959 B1	3/2002	Nicolette et al.	D620,993 S	8/2010	Laub
D474,821 S	5/2003	Wells et al.	7,887,432 B2	2/2011	Jones et al.
D483,086 S	12/2003	Schweigert et al.	7,909,707 B2	3/2011	Klein
D486,872 S	2/2004	Schweigert et al.	7,918,745 B2	4/2011	Morris et al.
D498,276 S	11/2004	Schweigert et al.	D638,891 S	5/2011	Nicolette et al.
6,902,496 B2	6/2005	Solheim et al.	D642,643 S	8/2011	Nicolette et al.
6,988,956 B2	1/2006	Cover et al.	D643,485 S	8/2011	Nicolette et al.
D531,242 S	10/2006	Adams	D645,104 S	9/2011	Nicolette et al.
D532,067 S	11/2006	Soracco et al.	8,096,039 B2	1/2012	Soracco et al.
7,153,220 B2	12/2006	Lo	D653,718 S *	2/2012	Stokke et al. .... D21/743
7,156,752 B1	1/2007	Bennett	D666,260 S *	8/2012	Cynn ..... D21/742
7,204,765 B2	4/2007	Cover et al.	D688,339 S	8/2013	Hilton et al.
D542,869 S	5/2007	Adams	D688,341 S	8/2013	Rollinson
D543,598 S *	5/2007	Kuan et al. .... D21/736	D691,226 S	10/2013	Hilton et al.
D561,854 S	2/2008	Morris	D699,308 S	2/2014	Rollinson
7,331,876 B2	2/2008	Klein	D704,782 S	5/2014	Rollinson
7,351,162 B2	4/2008	Soracco et al.	8,721,472 B2	5/2014	Kuan et al.
D569,461 S	5/2008	Morris	8,790,193 B2	7/2014	Serrano et al.
7,396,289 B2	7/2008	Soracco et al.	2007/0142122 A1	6/2007	Bonneau
D577,085 S	9/2008	Nicolette et al.	2007/0238548 A1	10/2007	Johnson
D577,086 S	9/2008	Nicolette et al.	2008/0176672 A1	7/2008	Roach et al.
			2011/0165959 A1	7/2011	Klein
			2013/0165256 A1	6/2013	Stevenson
			2013/0210537 A1	8/2013	Ainscough et al.

\* cited by examiner



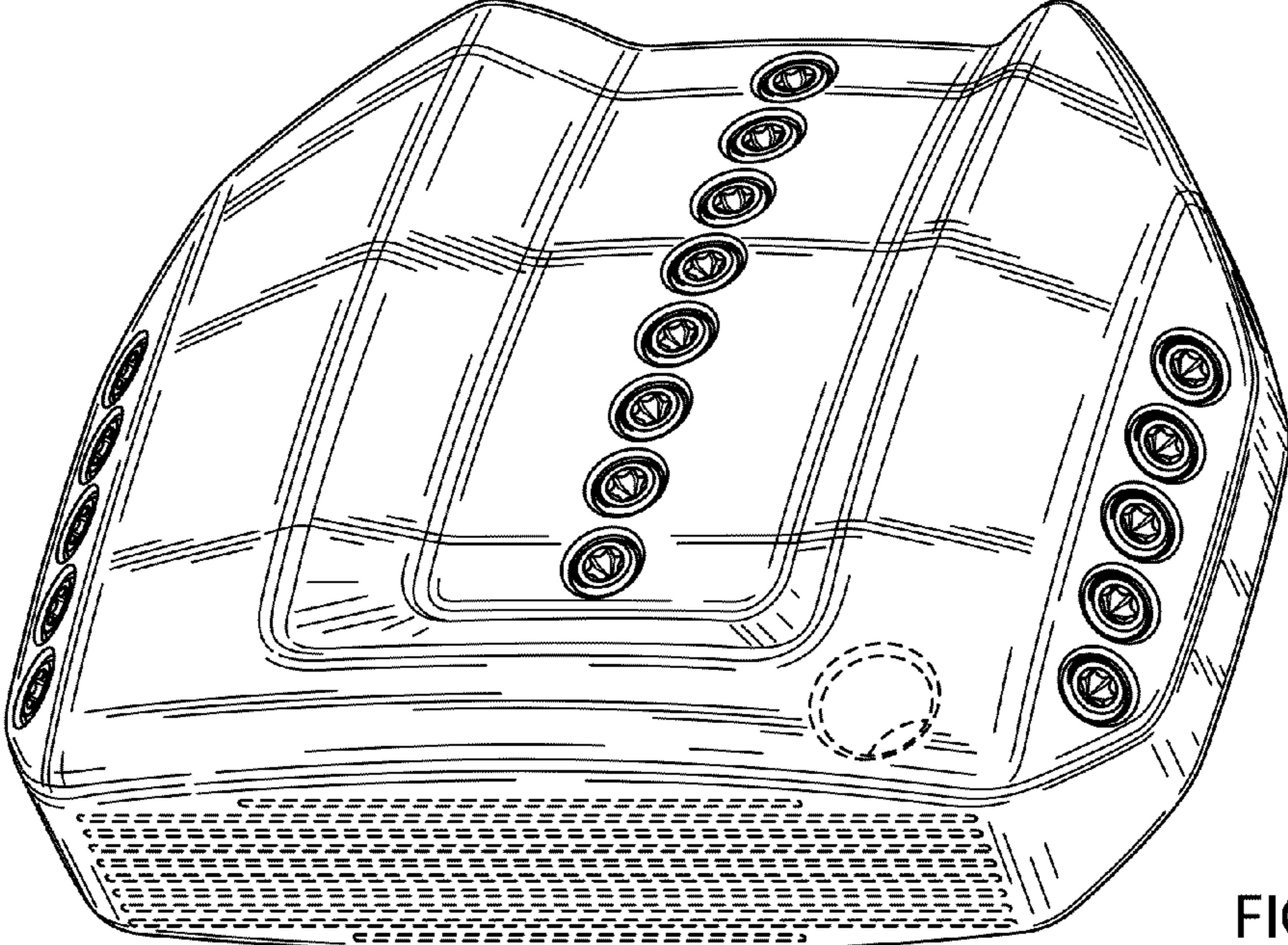

FIG. 1

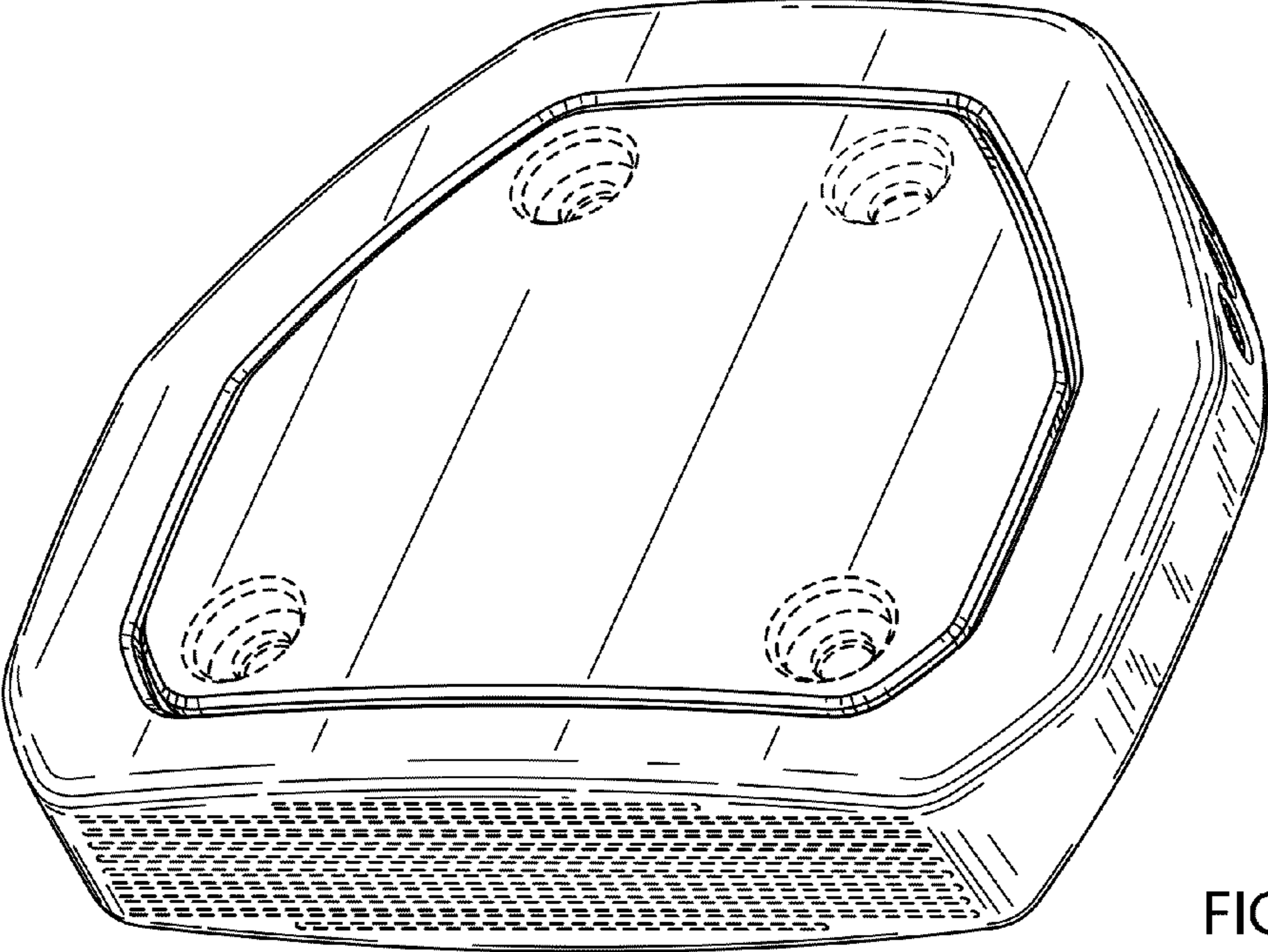

FIG. 2

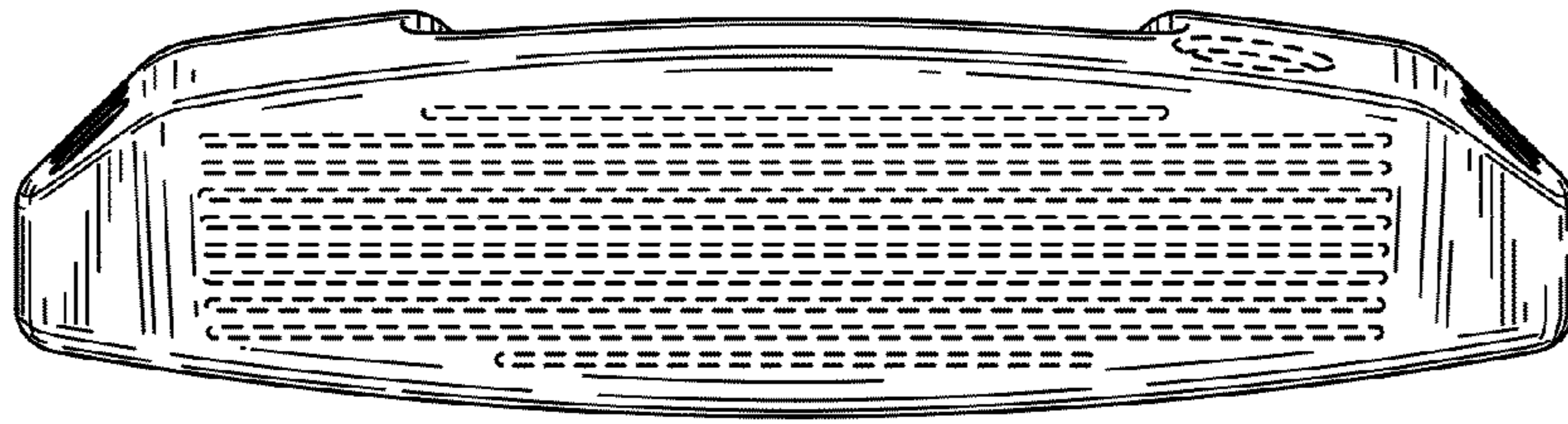

FIG. 3

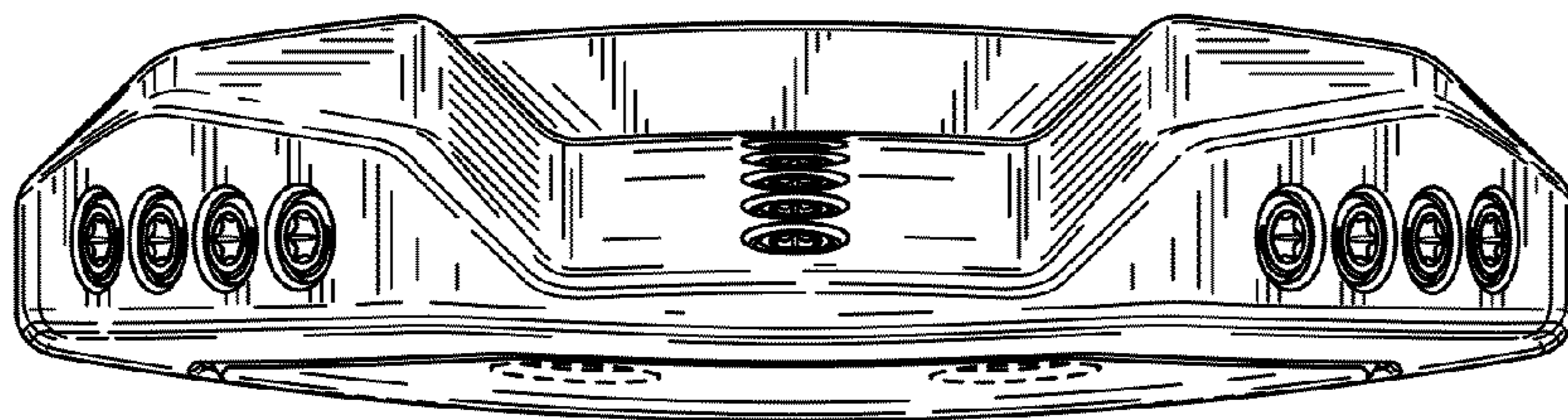

FIG. 4

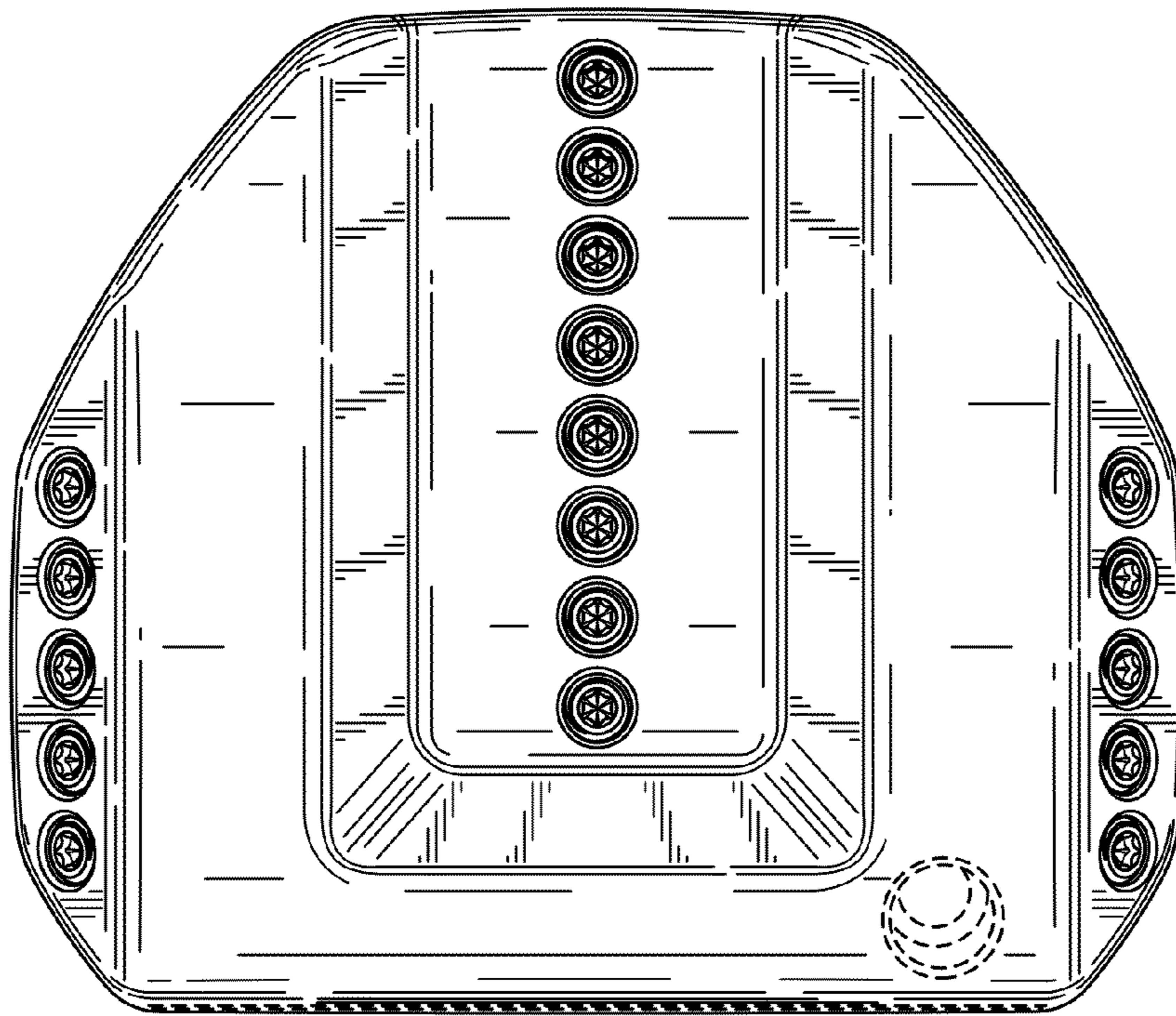

FIG. 5

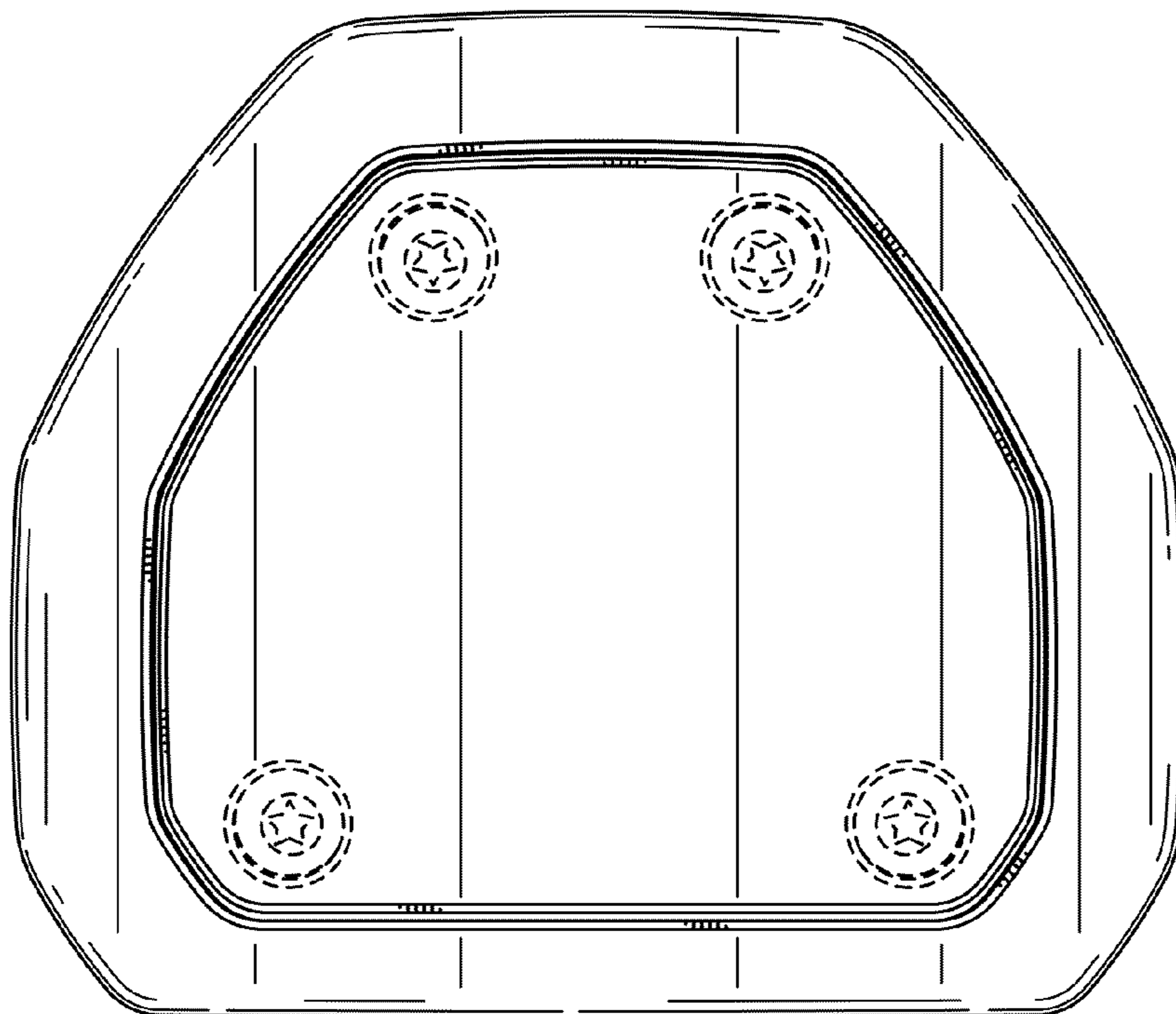

FIG. 6



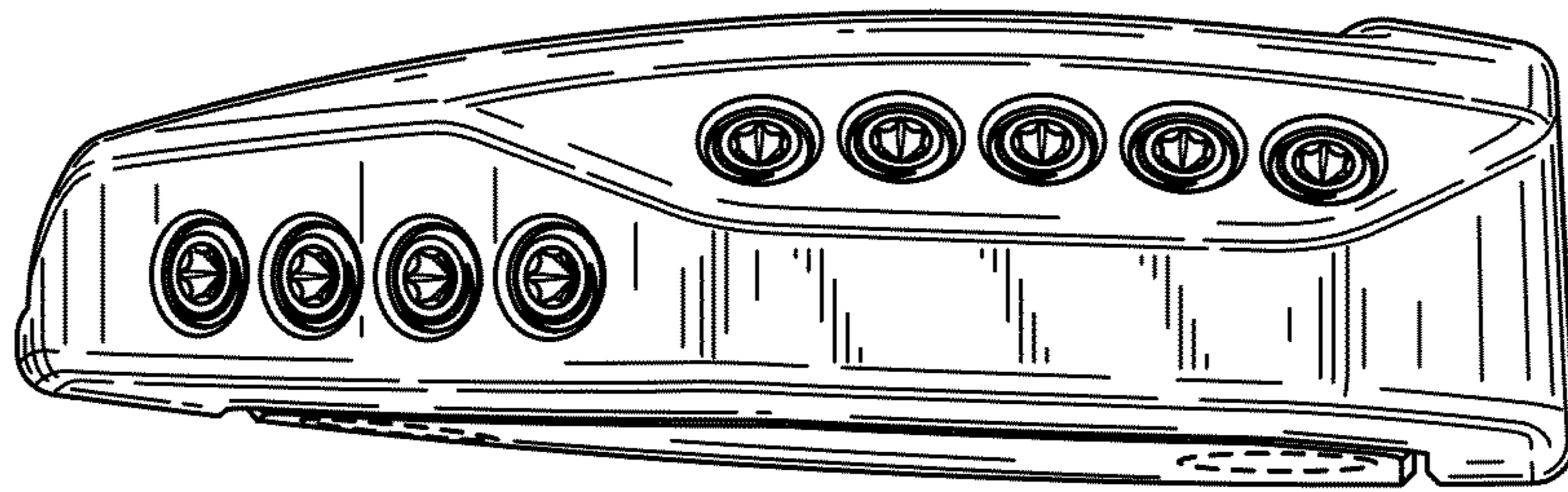

FIG. 7

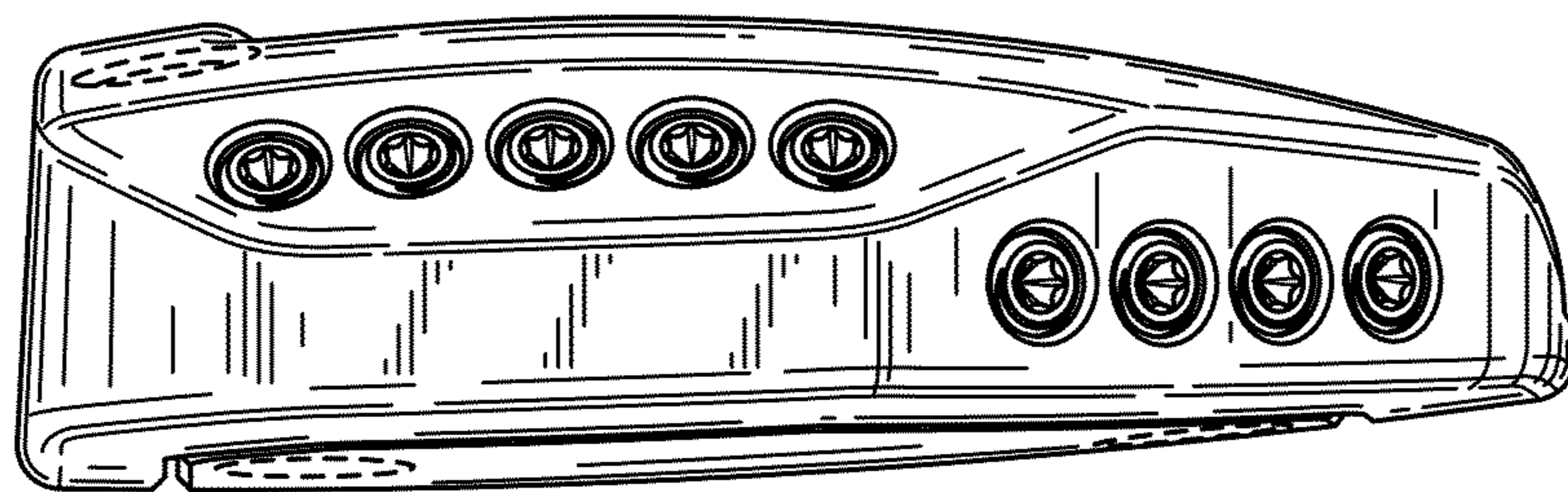

FIG. 8

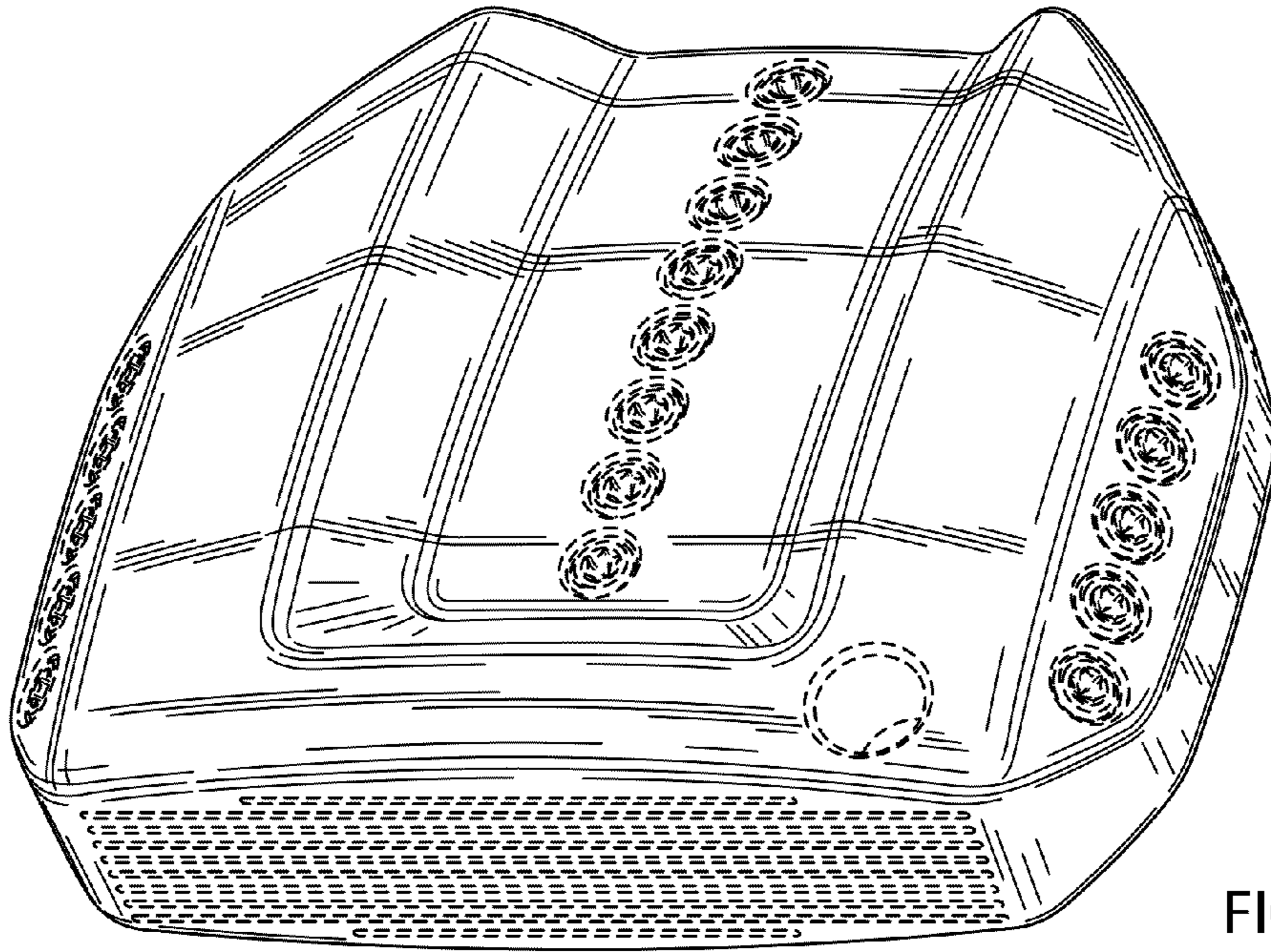

FIG. 9

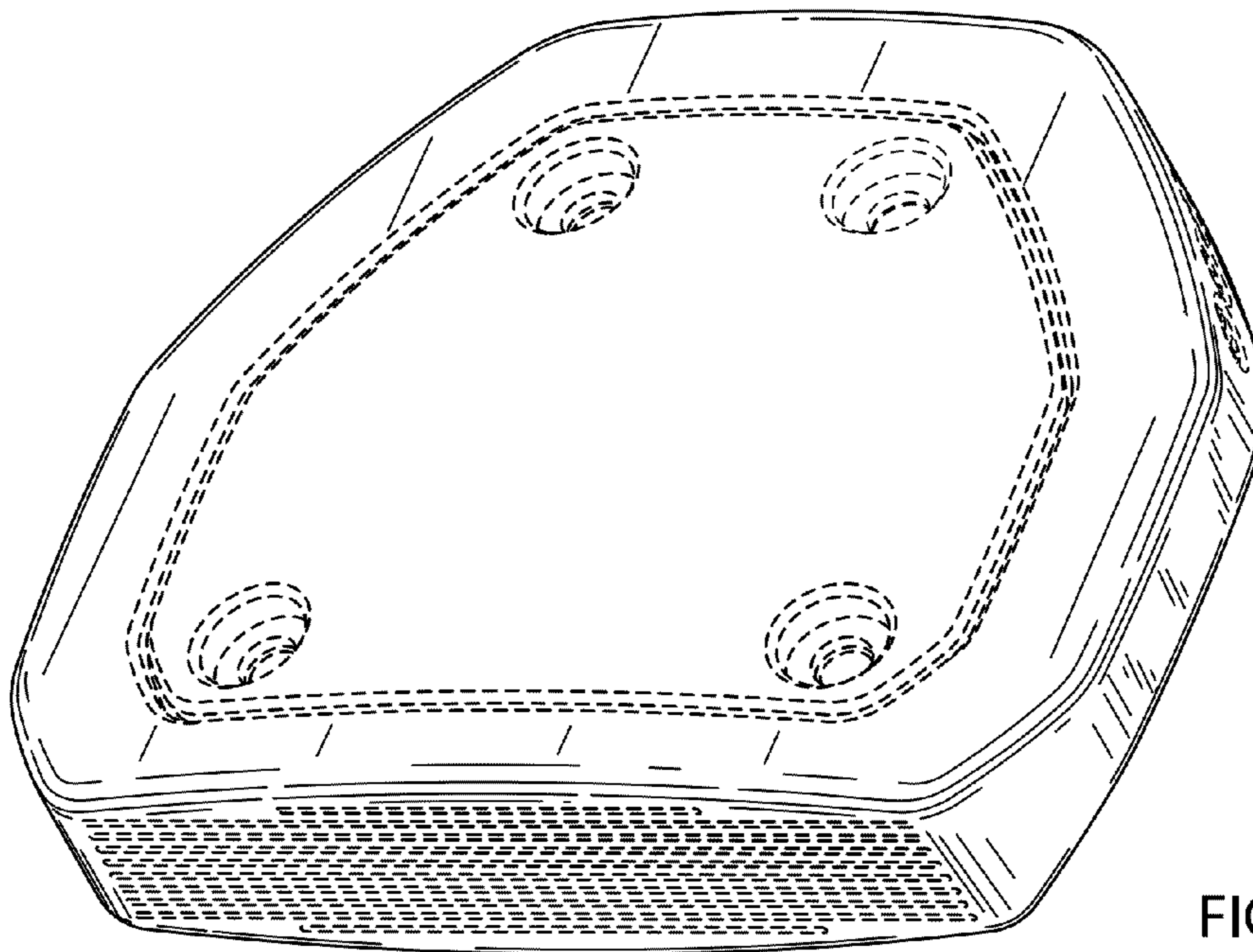

FIG. 10

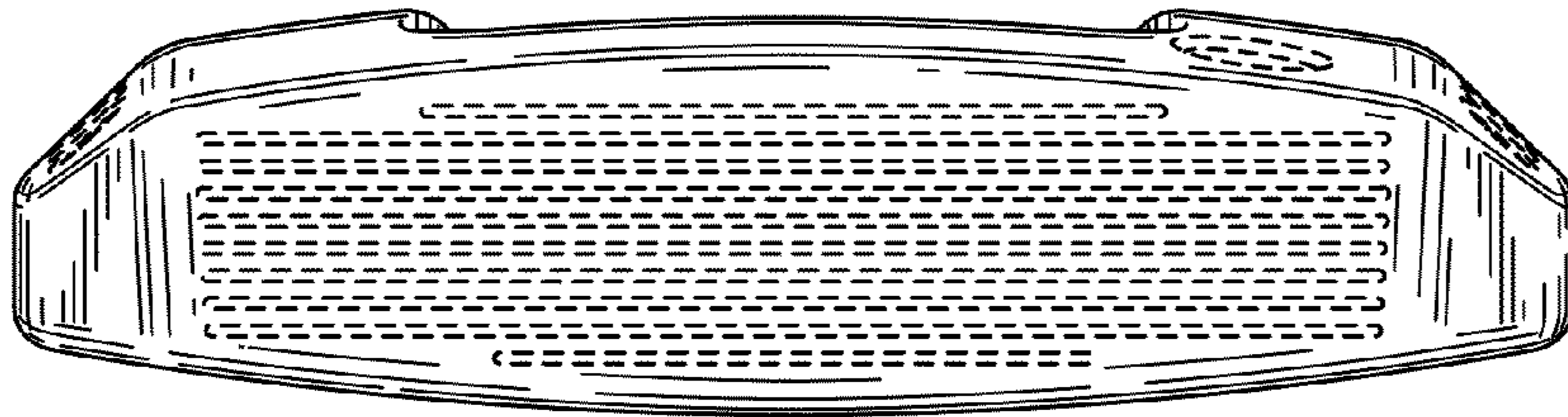

FIG. 11

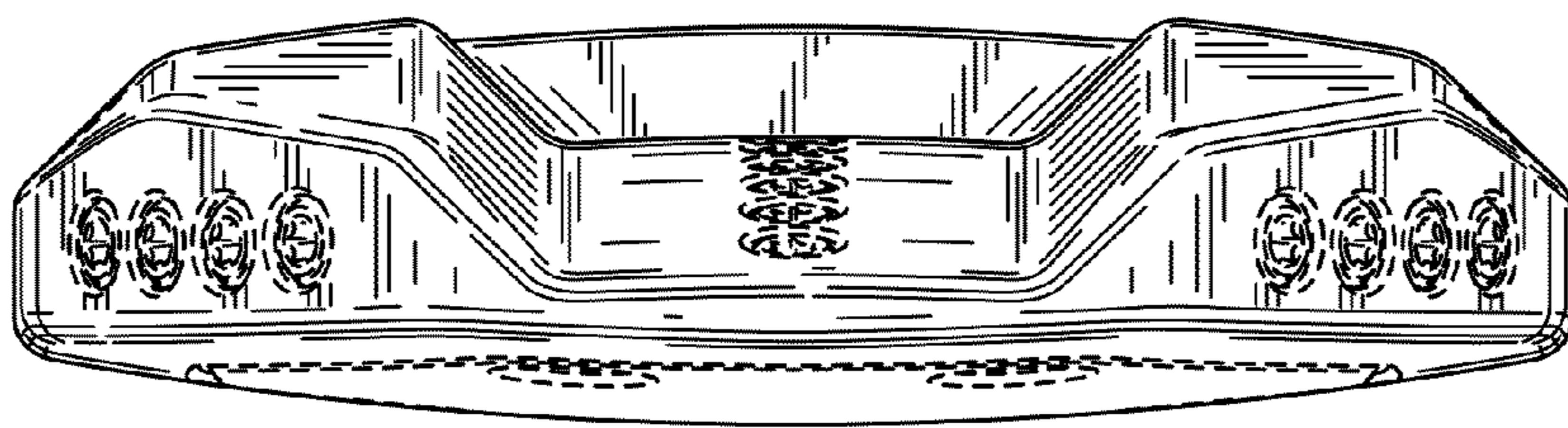

FIG. 12



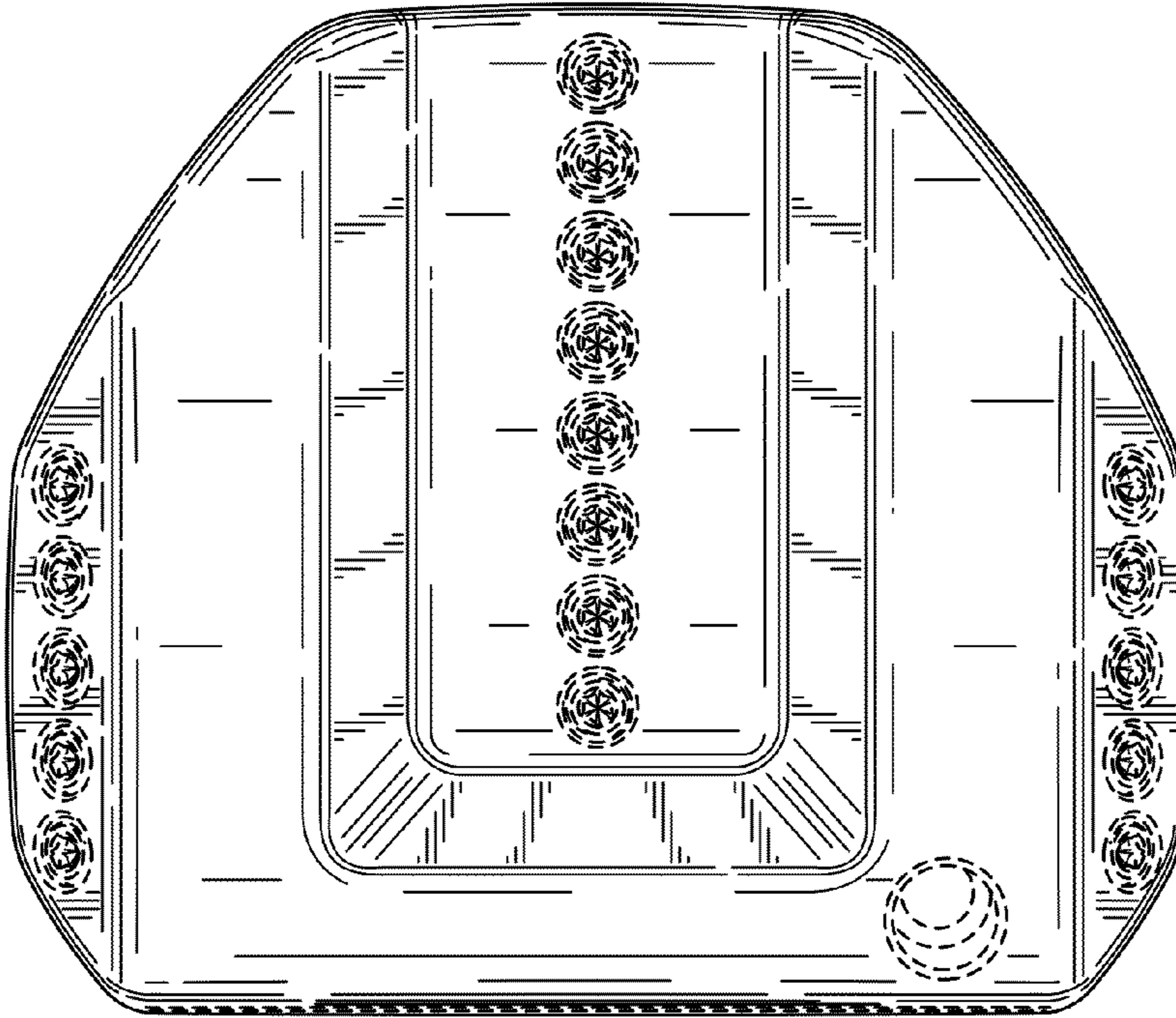

FIG. 13

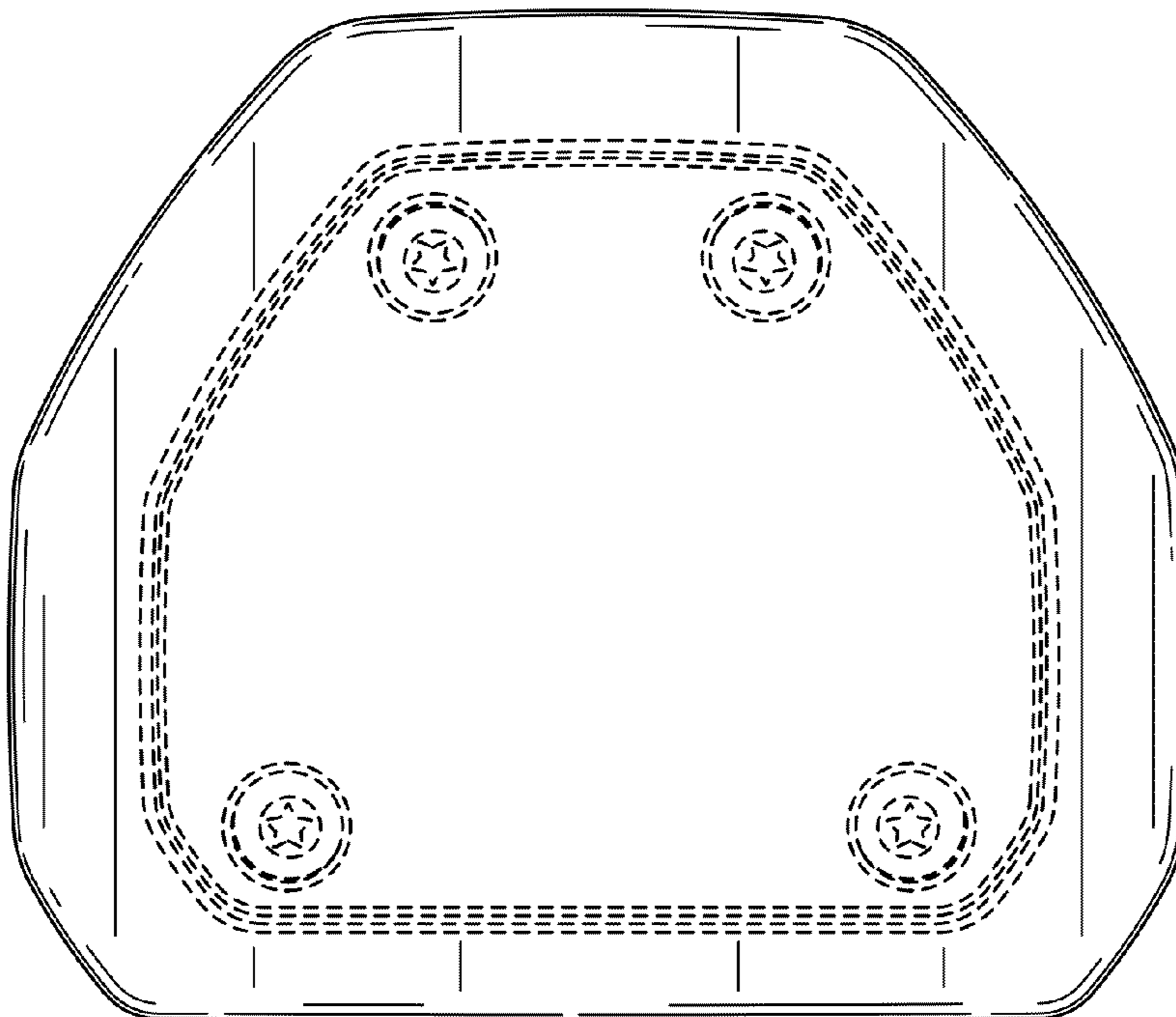

FIG. 14

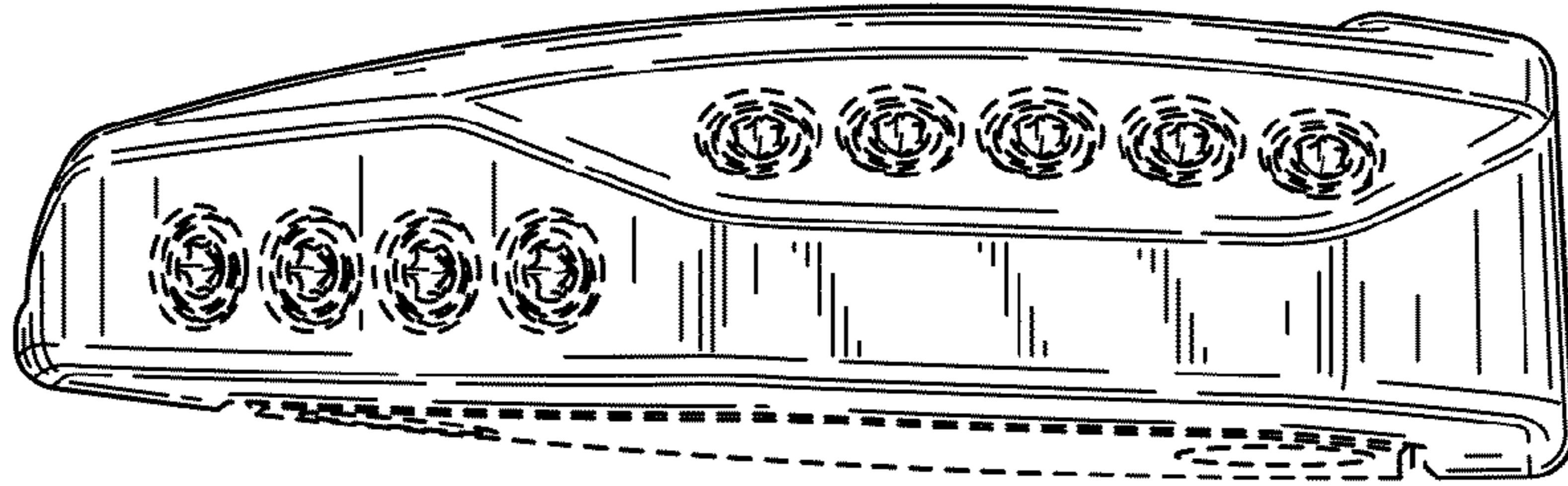

FIG. 15

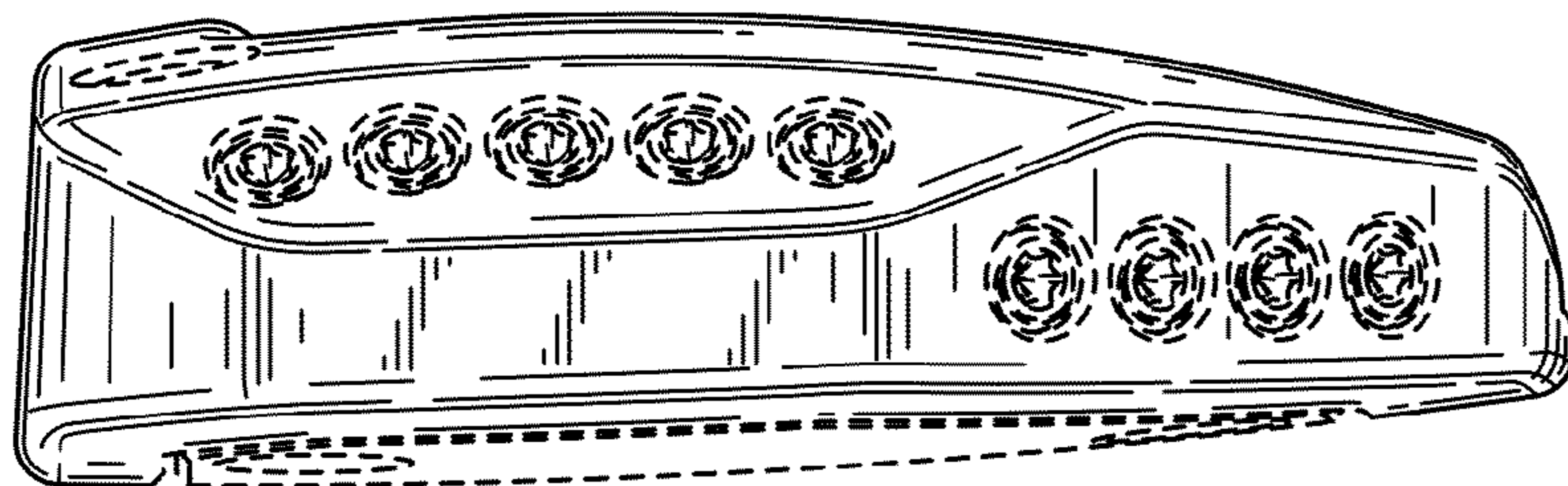

FIG. 16