



US00D722211S

(12) **United States Design Patent**
Thackray et al.

(10) **Patent No.:** **US D722,211 S**
(45) **Date of Patent:** **** Feb. 3, 2015**

(54) **VACUUM CLEANER**

(71) Applicant: **Koninklijke Philips Electronics N.V.**,
Eindhoven (NL)

(72) Inventors: **Donald Thackray**, Zuidlaren (NL); **Lv Wei**, Suzhou (CN)

(73) Assignee: **Koninklijke Philips N.V.**, Eindhoven (NL)

(**) Term: **14 Years**

(21) Appl. No.: **29/453,507**

(22) Filed: **Apr. 30, 2013**

(30) **Foreign Application Priority Data**

Oct. 31, 2012 (EM) 002128934-0001

(51) **LOC (10) Cl.** **15-05**

(52) **U.S. Cl.**
USPC **D32/22**

(58) **Field of Classification Search**
USPC D32/17, 22, 31, 34; 15/347, 320-322,
15/350-35, 410-412, 414, 361-362, 4
See application file for complete search history.

(56) **References Cited**

U.S. PATENT DOCUMENTS

D399,618	S	*	10/1998	Jacobs	D32/22
D482,506	S	*	11/2003	Honda et al.	D32/22
D483,160	S	*	12/2003	Houghton	D32/22
D515,259	S	*	2/2006	Maruyama et al.	D32/22
D521,699	S	*	5/2006	Greene et al.	D32/22
D537,584	S	*	2/2007	Greene et al.	D32/22
D662,677	S	*	6/2012	Bilger et al.	D32/22
D671,283	S	*	11/2012	Paterson	D32/22

* cited by examiner

Primary Examiner — Ruth McInroy

(57) **CLAIM**

The ornamental design for a vacuum cleaner, as shown and described.

DESCRIPTION

FIG. 1 is a perspective view of a vacuum cleaner showing our new design;

FIG. 2 is a front elevational view thereof;

FIG. 3 is a rear elevational view thereof;

FIG. 4 is a right side elevational view thereof;

FIG. 5 is a left side elevational view thereof;

FIG. 6 is a top plan view thereof; and,

FIG. 7 is a bottom plan view thereof.

The details shown in broken lines form no part of the claimed design.

1 Claim, 4 Drawing Sheets

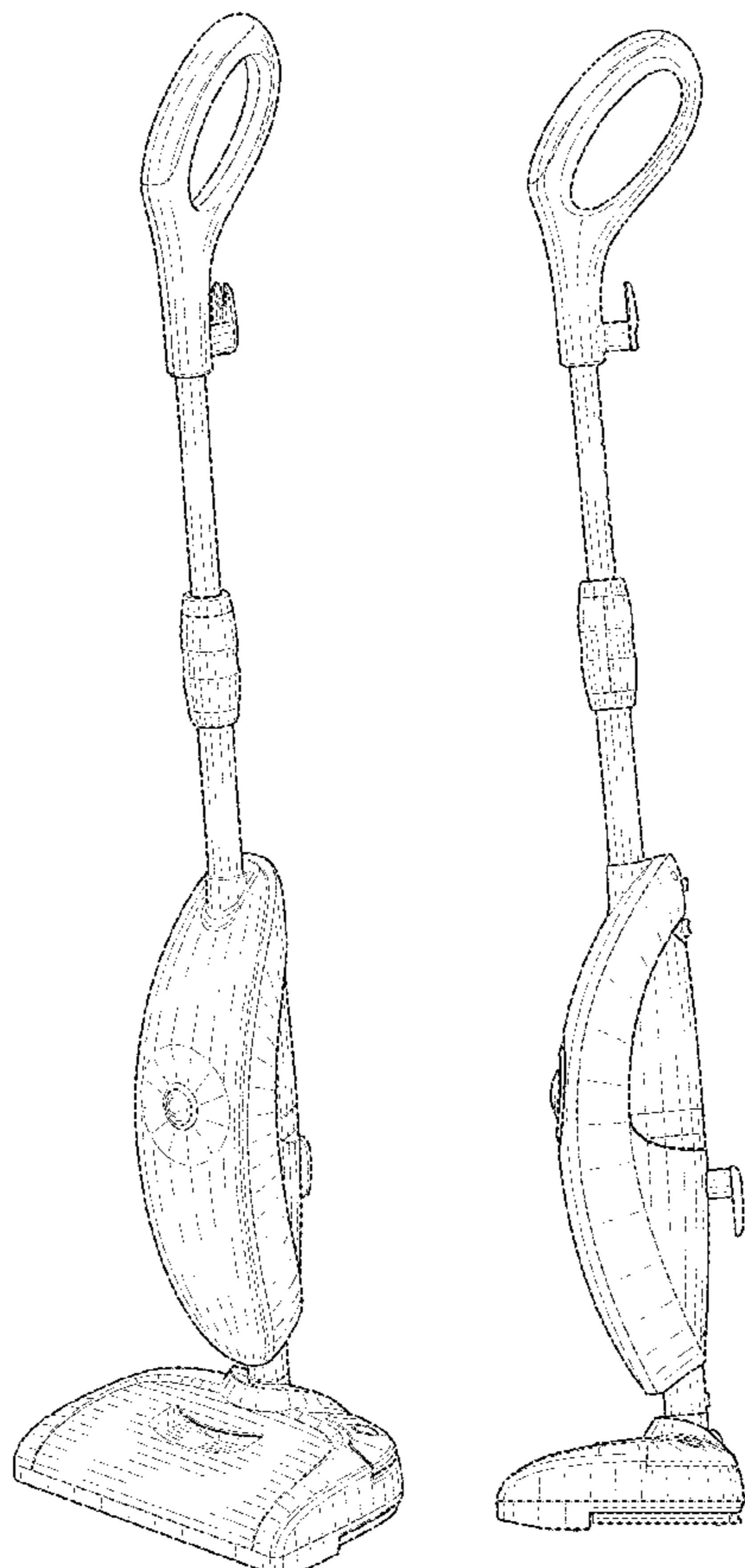

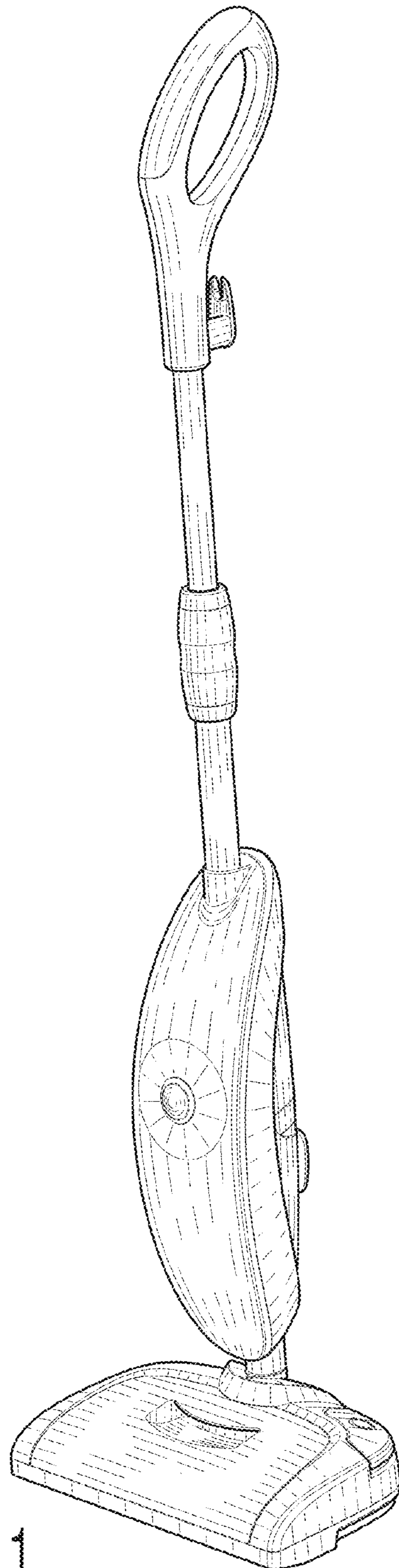

FIG. 1

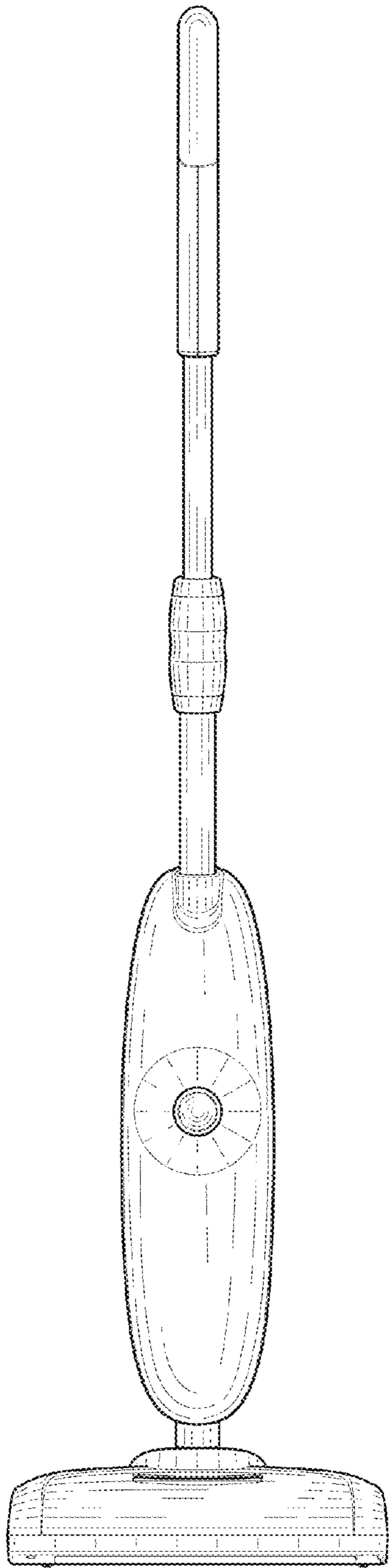

FIG. 2

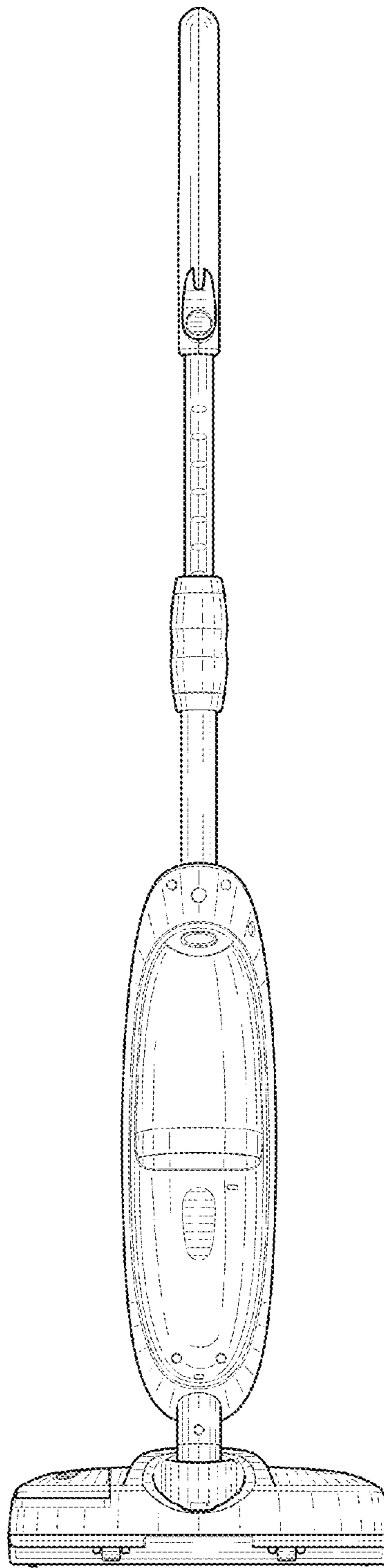

FIG. 3

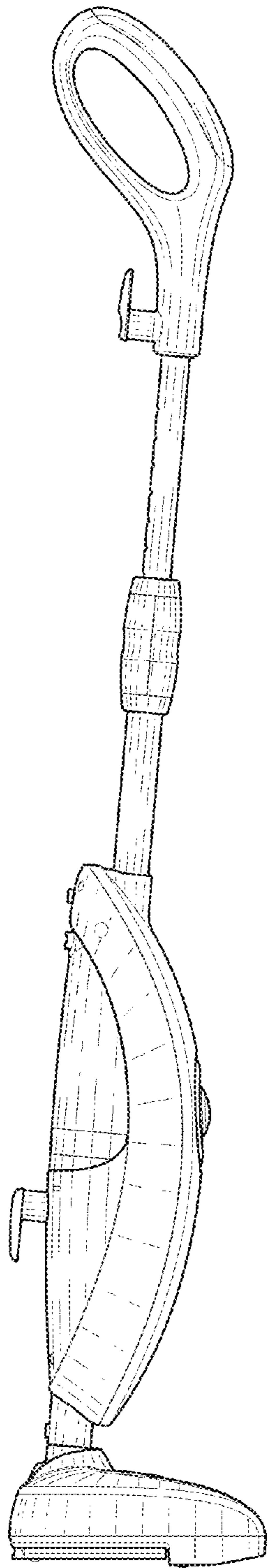

FIG. 4

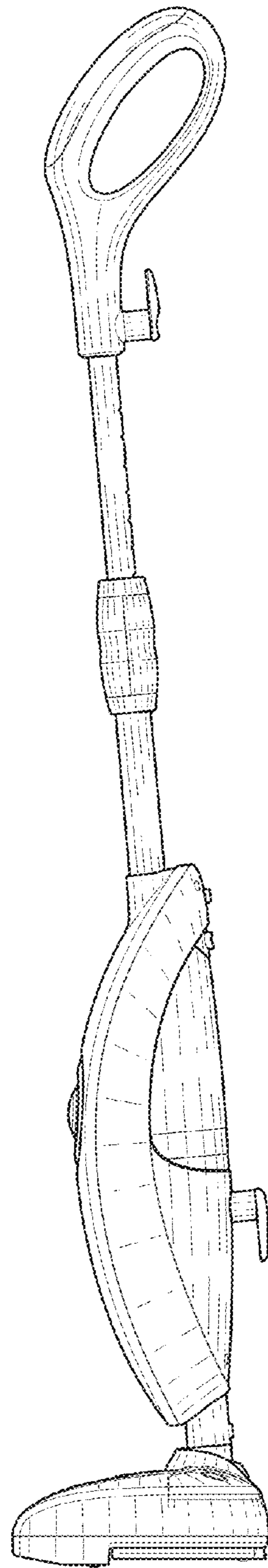

FIG. 5

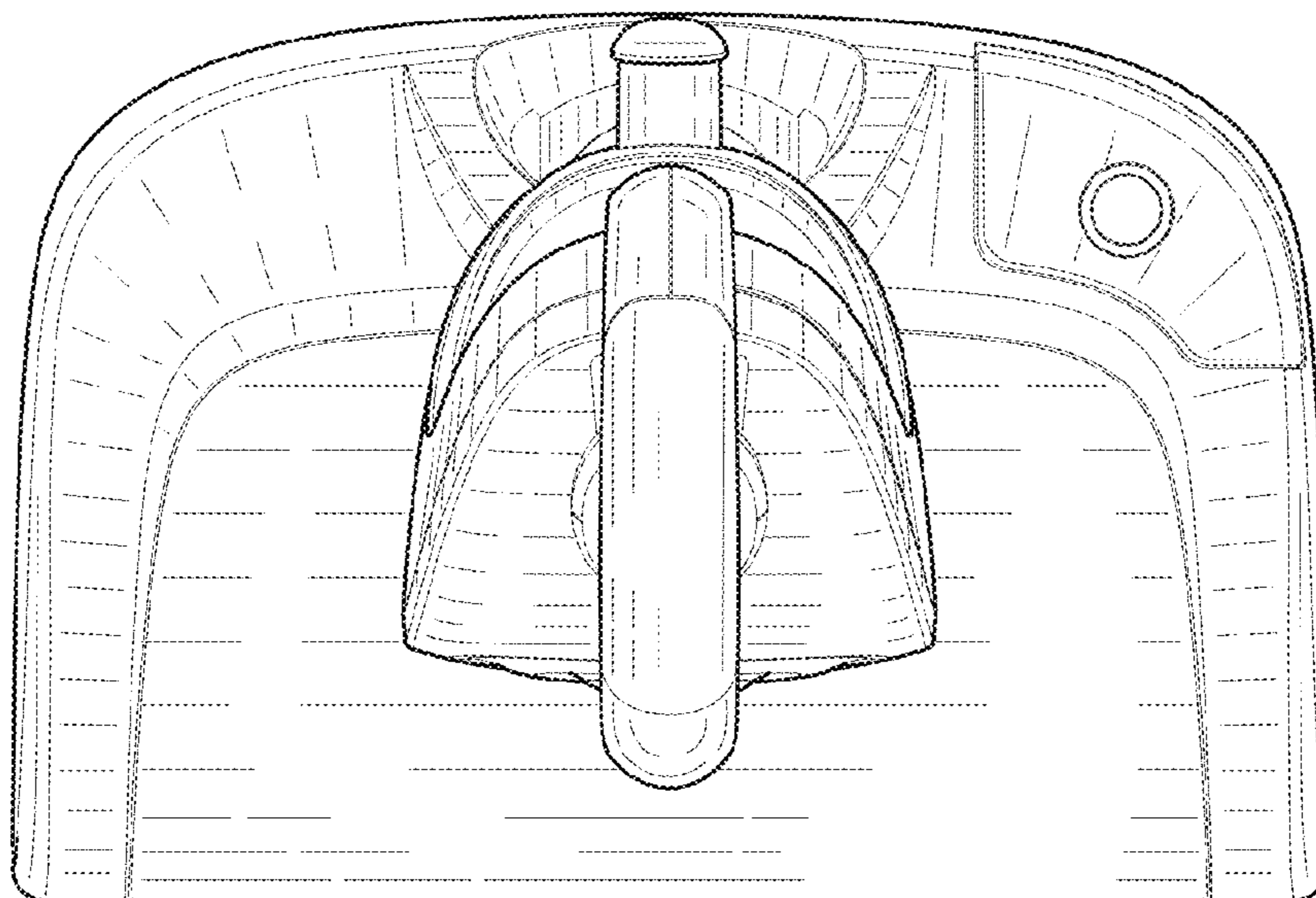

FIG. 6

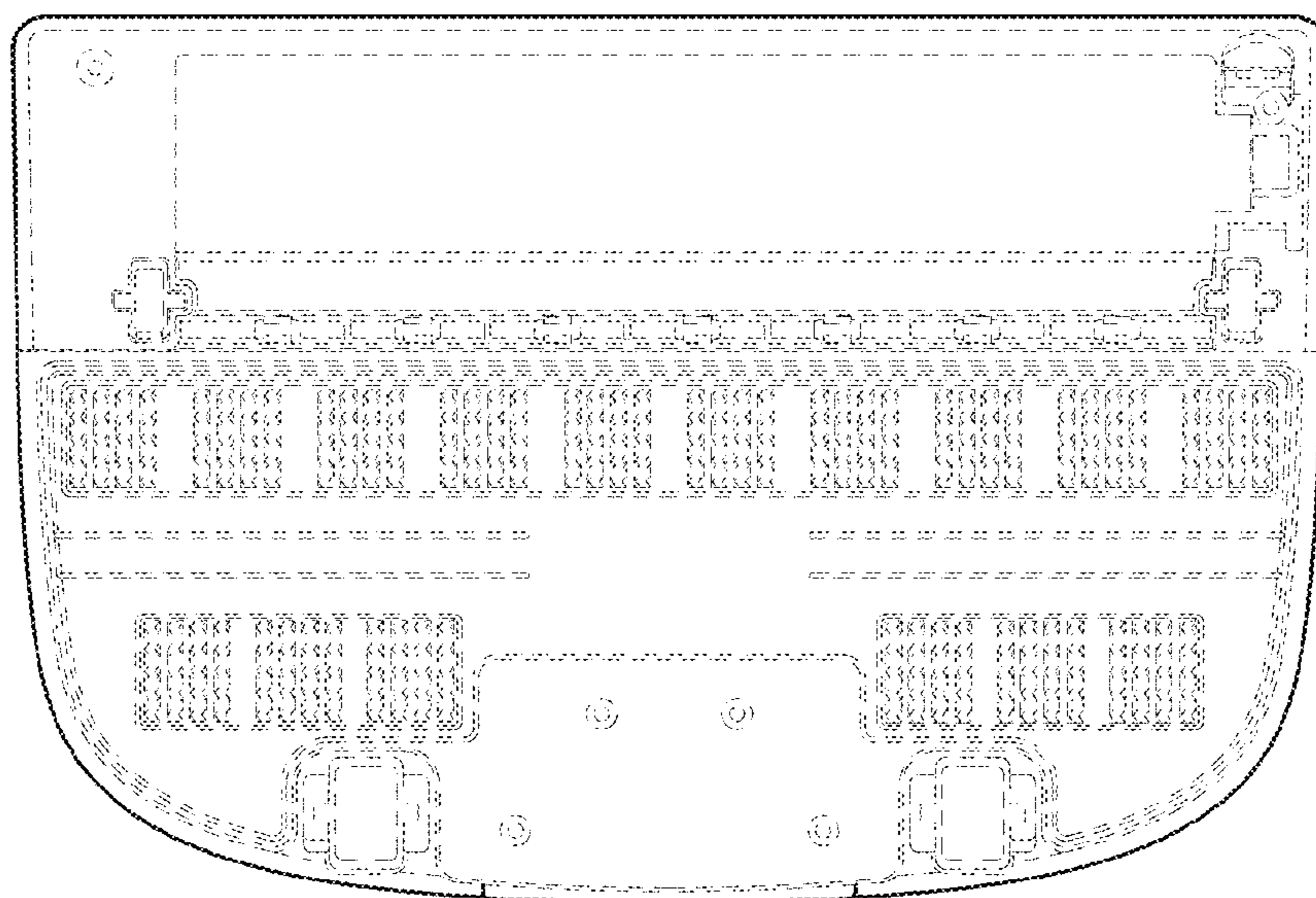

FIG. 7