



US00D722168S

(12) **United States Design Patent**  
**Darkes**

(10) **Patent No.:** **US D722,168 S**  
(45) **Date of Patent:** **\*\* Feb. 3, 2015**

(54) **HEARING AID**

D676,968 S \* 2/2013 Meinertz ..... D24/174  
D698,027 S \* 1/2014 Olsen ..... D24/174  
D705,936 S \* 5/2014 Lockenwitz ..... D24/174

(71) Applicant: **Phonak AG**, Stafa (CH)

\* cited by examiner

(72) Inventor: **Paul Darkes**, New Dundee (CA)

*Primary Examiner* — Anhdao Doan

(73) Assignee: **Phonak AG**, Stafa (CH)

(74) *Attorney, Agent, or Firm* — Rankin, Hill & Clark LLP

(\*\*) Term: **14 Years**

(21) Appl. No.: **29/487,747**

(57) **CLAIM**

The ornamental design for a hearing aid, as shown and described.

(22) Filed: **Apr. 11, 2014**

(30) **Foreign Application Priority Data**

**DESCRIPTION**

Oct. 14, 2013 (WO) ..... DM/081 971

(51) **LOC (10) Cl.** ..... **24-99**

(52) **U.S. Cl.**  
USPC ..... **D24/174**

(58) **Field of Classification Search**  
USPC ..... D24/173–175, 151; D14/205, 206,  
D14/223–226, 249; 381/23.1, 312,  
381/322–324, 328, 330, 380, 381; 181/135  
See application file for complete search history.

FIG. 1 is a perspective view of a hearing aid embodying the design;

FIG. 2 is a front view of the hearing aid shown in FIG. 1;

FIG. 3 is a rear view of the hearing aid shown in FIG. 1;

FIG. 4 is a top view of the hearing aid shown in FIG. 1;

FIG. 5 is a bottom view of the hearing aid shown in FIG. 1;

FIG. 6 is a left side elevational view of the hearing aid shown in FIG. 1; and,

FIG. 7 is a right side elevational view of the hearing aid shown in FIG. 1.

The broken lines immediately adjacent the shaded areas represent the bounds of the claim, and all other broken lines represent unclaimed portions of the hearing aid. None of the broken lines form a part of the claimed design.

(56) **References Cited**

**U.S. PATENT DOCUMENTS**

D646,788 S \* 10/2011 Dubs et al. .... D24/174  
D674,094 S \* 1/2013 Takano et al. .... D24/174

**1 Claim, 2 Drawing Sheets**

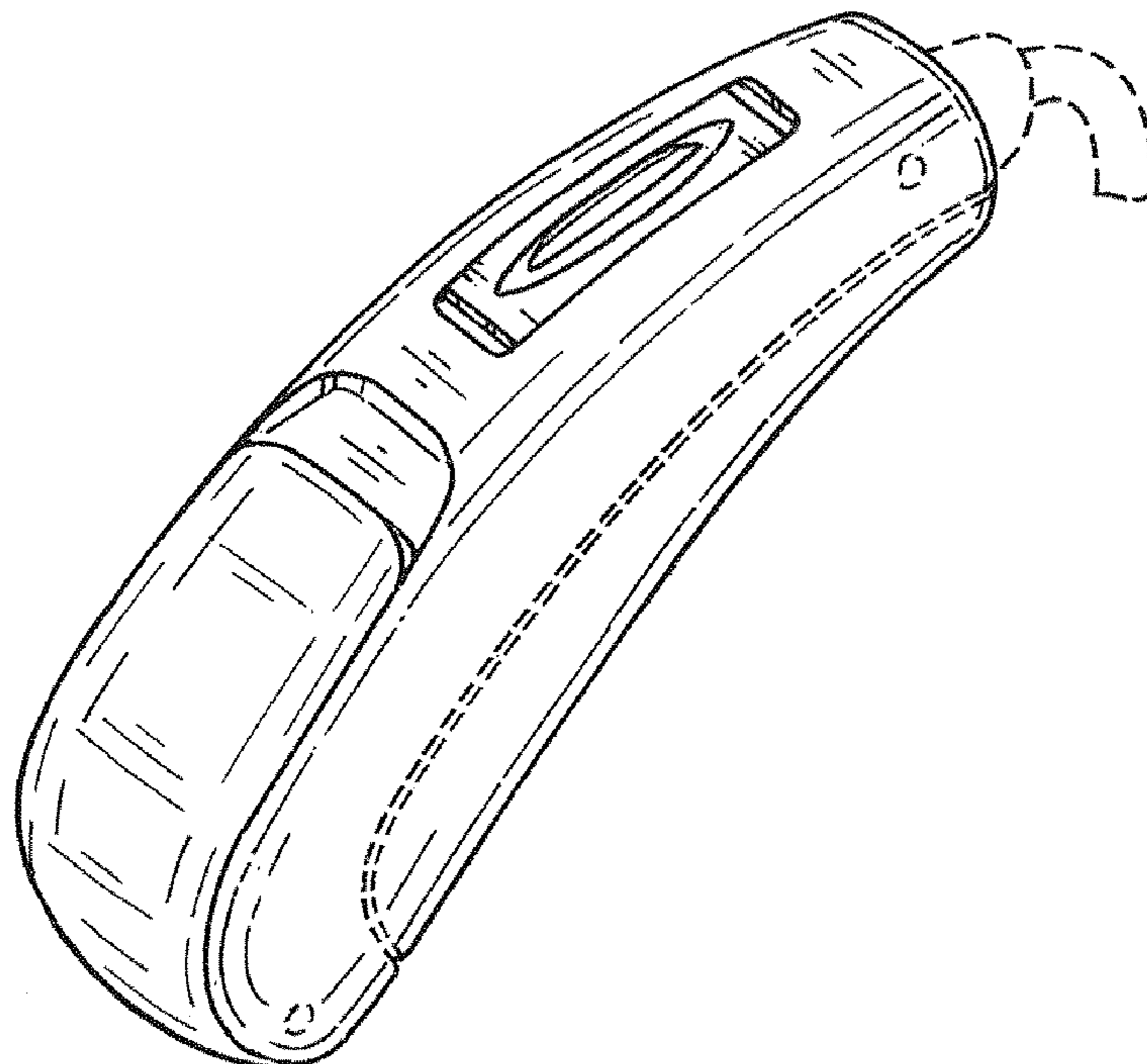

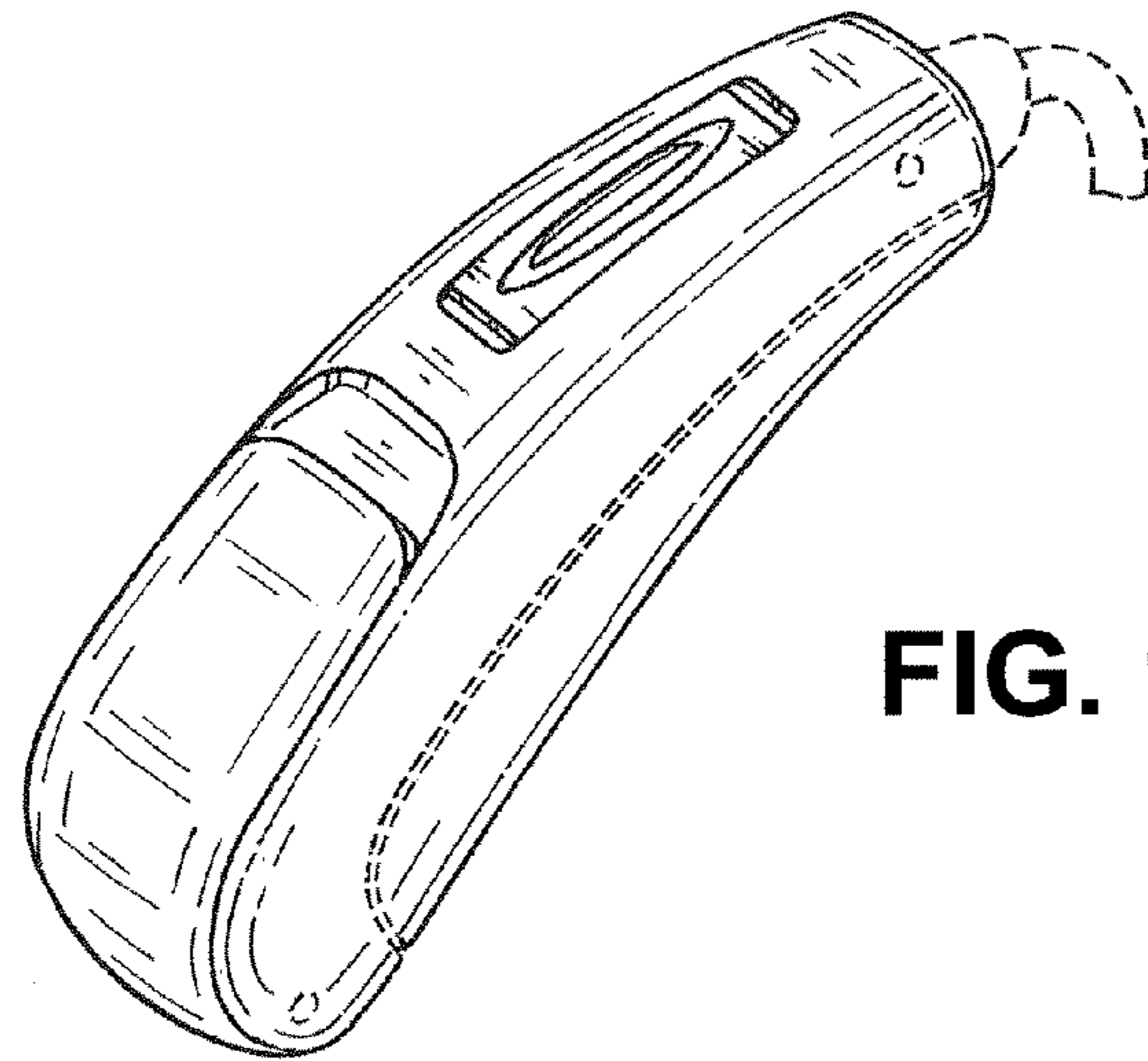

FIG. 1

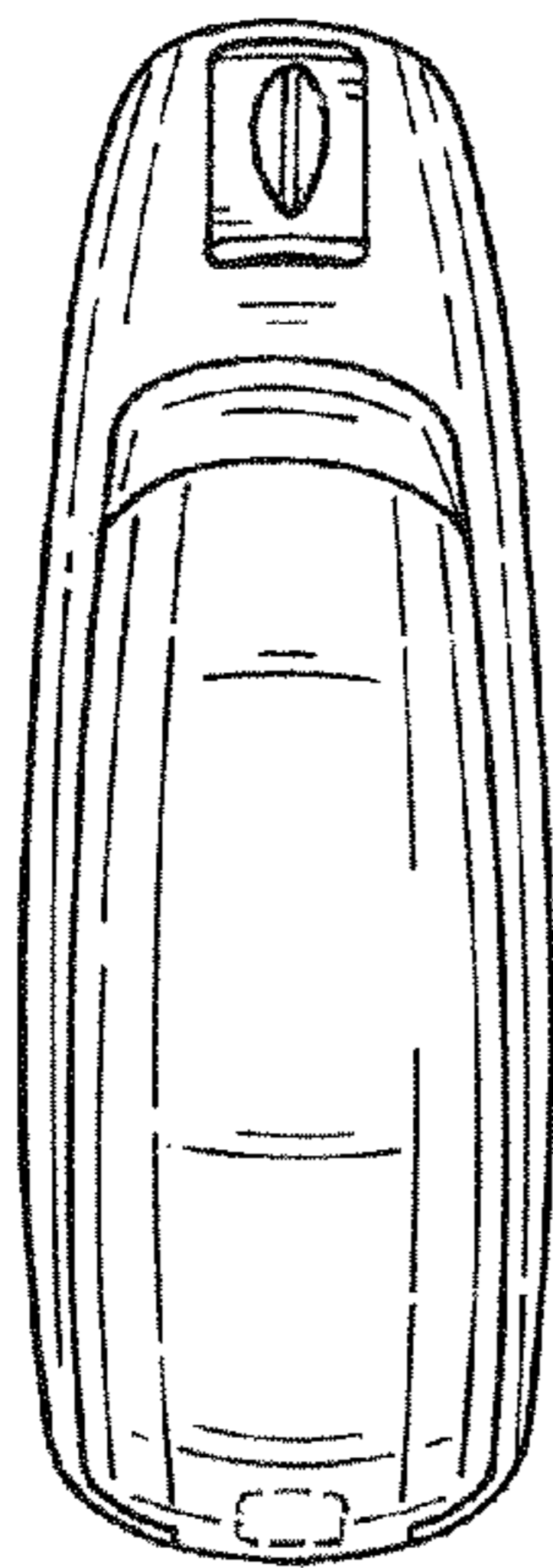

FIG. 2

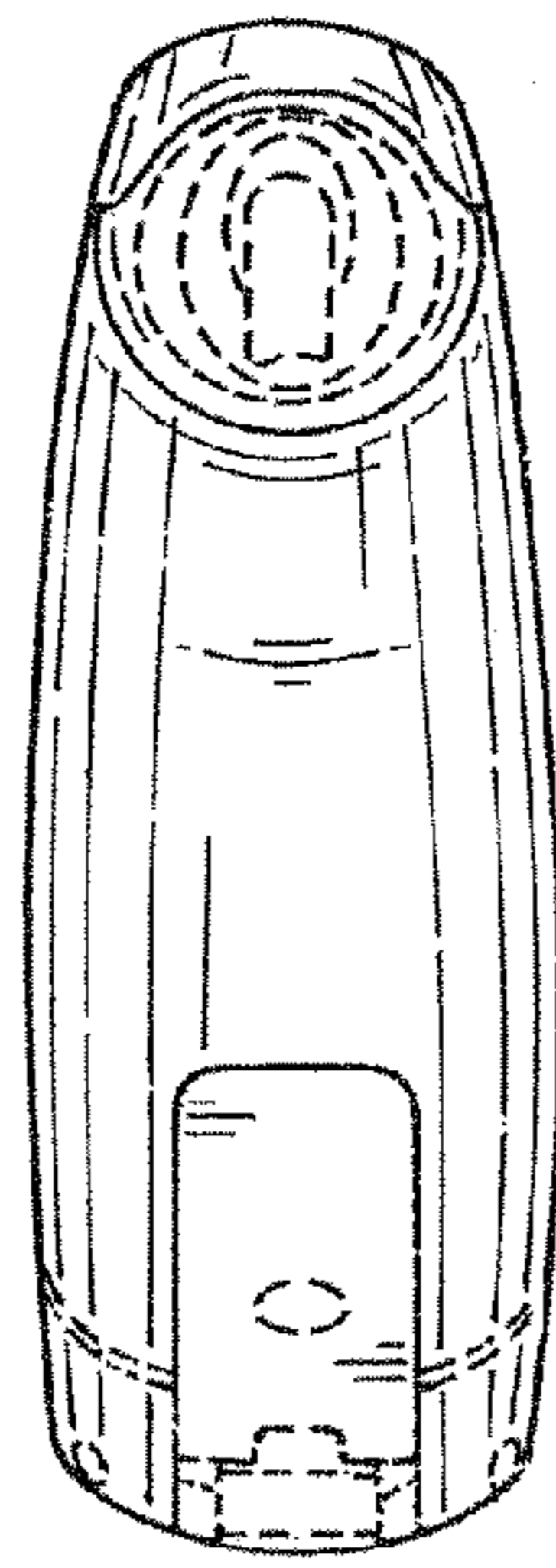

FIG. 3

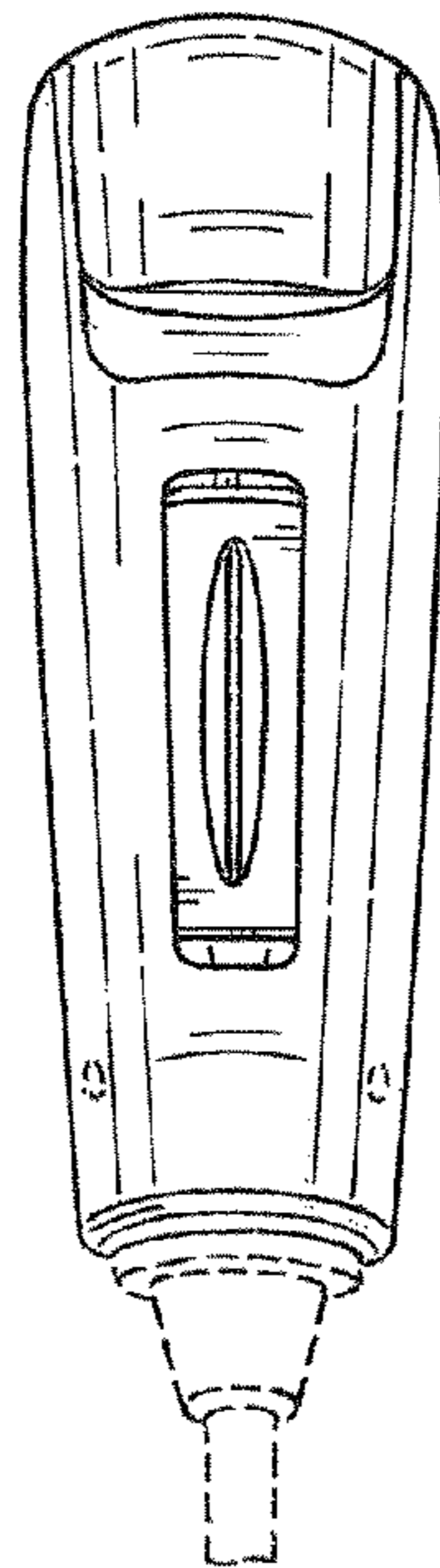

FIG. 4

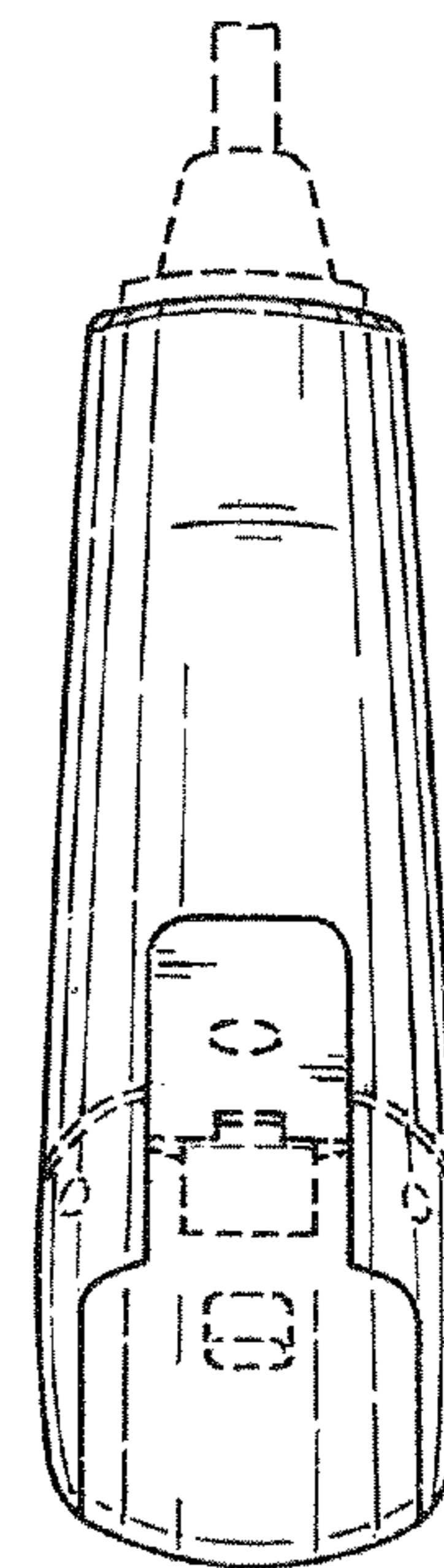
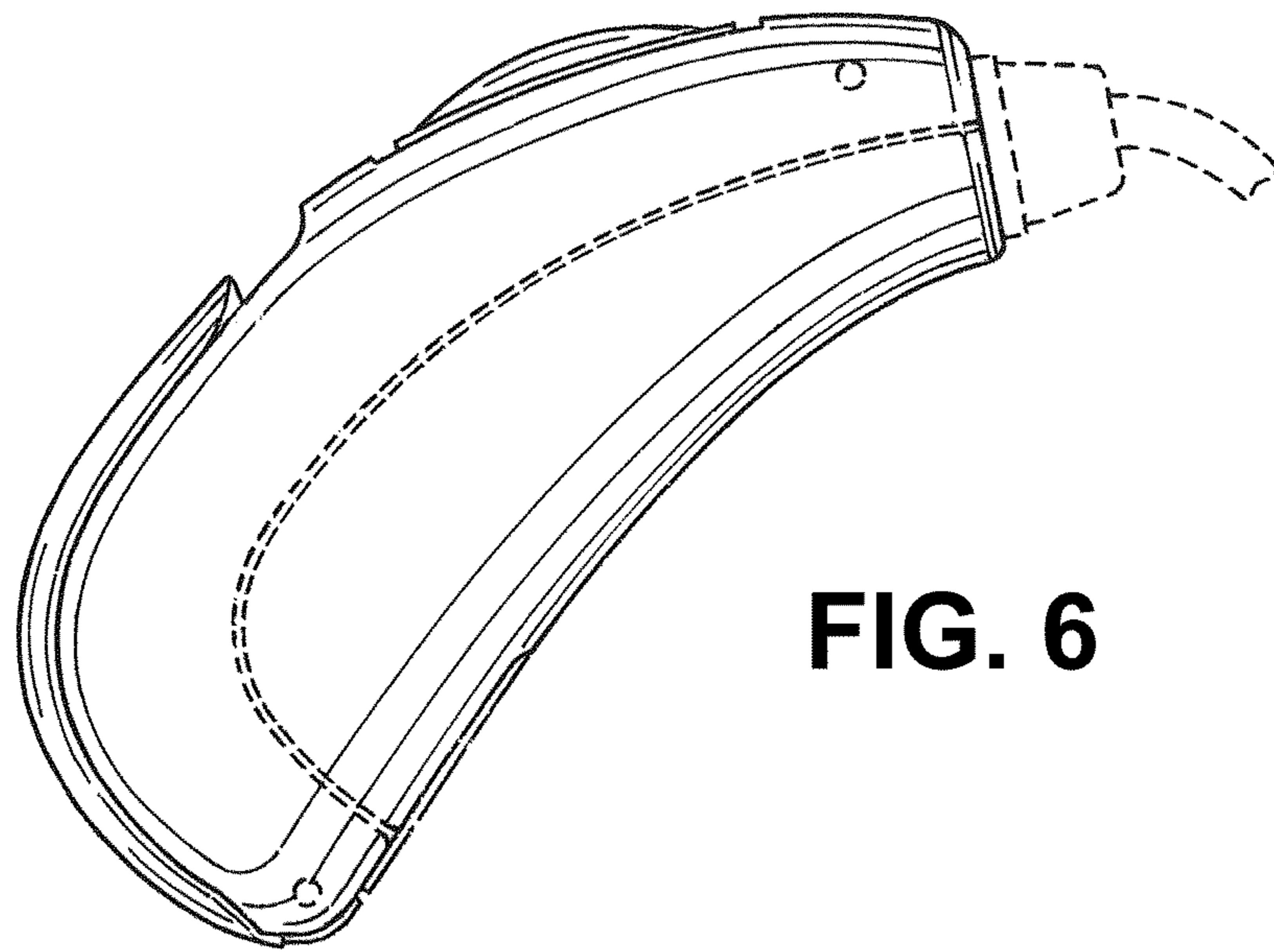
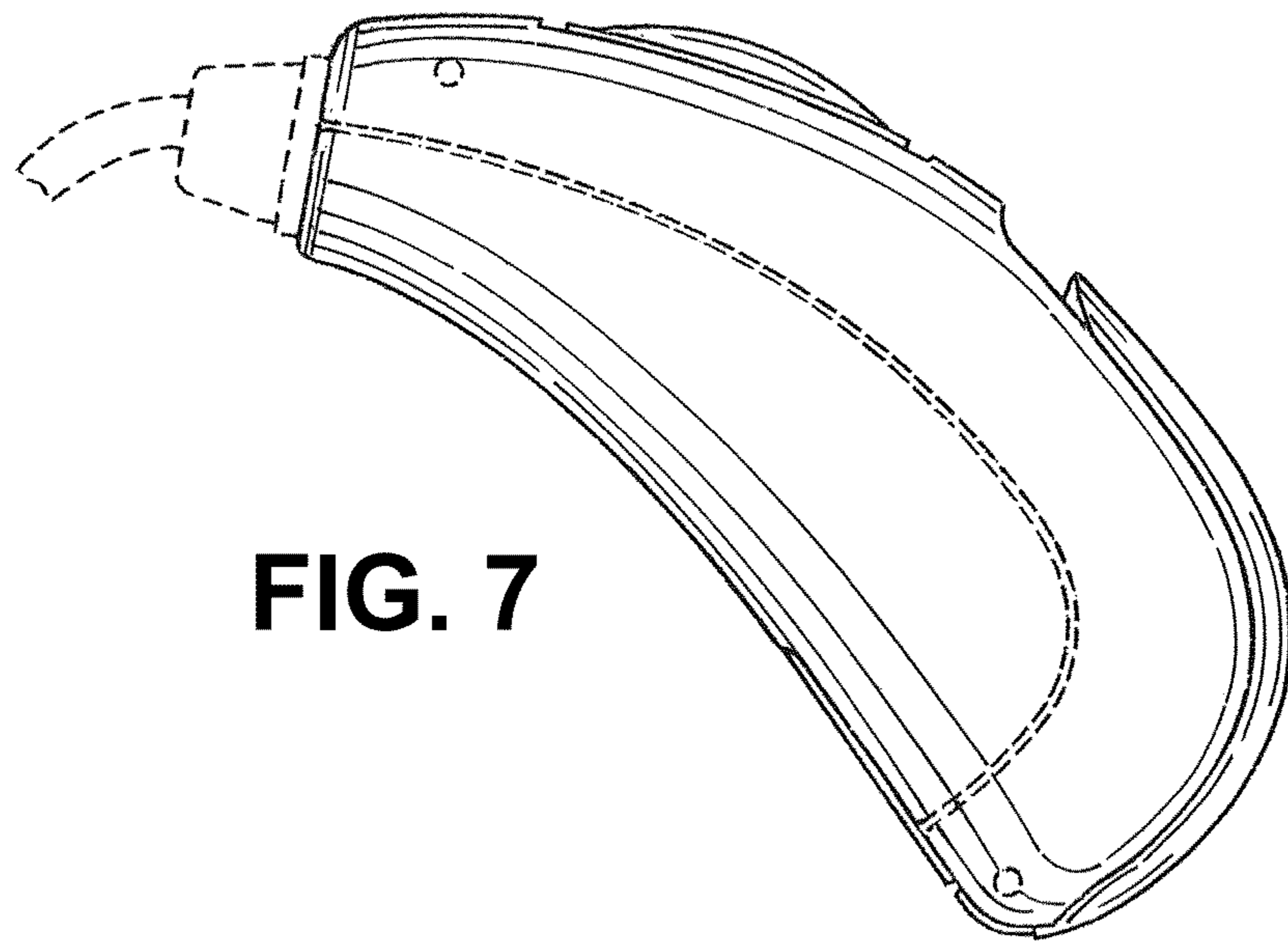

FIG. 5



**FIG. 6**



**FIG. 7**